

**QFP, PQFP, TQFP (Clamshell)**

# IC51 Series

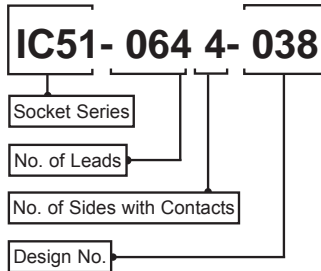

### Characteristics

Insulation Resistance: 1,000M $\Omega$  minimum at 500 VDC  
 Withstanding Voltage: 700 VAC for 1 minute  
 Contact Resistance: 30m $\Omega$  max. at 10mA/20mV (Initial)  
 Operating Temperature: PES/PEI -55°C ~ +170°C  
 PSF -40°C ~ +150°C

### Material

Insulator: PSF / PES / PEI  
 Contact: Beryllium Copper  
 Plating: Gold over Nickel

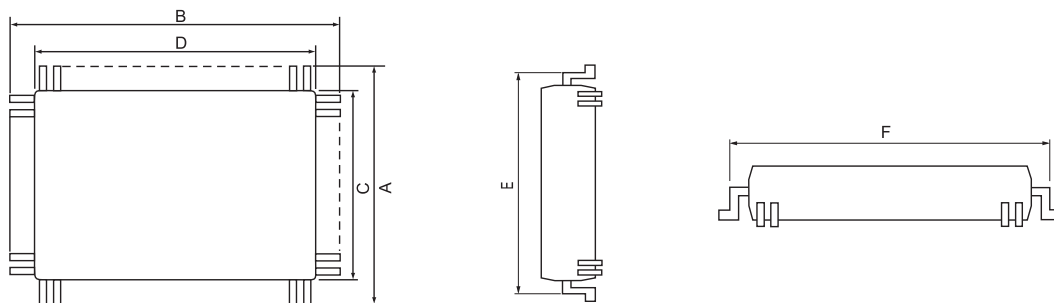

(Reference Only)

| Part Number      | No. of Leads | Body Size | Pitch | Matching Package Size |      |      |      |         |         | Notes          |
|------------------|--------------|-----------|-------|-----------------------|------|------|------|---------|---------|----------------|
|                  |              |           |       | A                     | B    | C    | D    | E (Max) | F (Max) |                |
| IC51-0324-805    | 32           | 5 x 5     | 0.5   | 7.0                   | 7.0  | 5.0  | 5.0  | 6.2     | 6.2     | Floating Base  |
| IC51-0324-354    | 32           | 7 x 7     | 0.8   | 9.0                   | 9.0  | 7.0  | 7.0  | 8.4     | 8.4     |                |
| IC51-0324-1498   | 32           | 7 x 7     | 0.8   | 9.0                   | 9.0  | 7.0  | 7.0  | 8.4     | 8.4     |                |
| QFP11T044-001*   | 44           | 10 x 10   | 0.8   | 12.0                  | 12.0 | 10.0 | 10.0 | 11.3    | 11.3    |                |
| IC51-0444-1195-3 | 44           | 10 x 10   | 0.8   | 12.6                  | 12.6 | 10.0 | 10.0 | 11.5    | 11.5    |                |
| IC51-0444-825    | 44           | 10 x 10   | 0.8   | 12.6                  | 12.6 | 10.0 | 10.0 | 11.7    | 11.7    |                |
| IC51-467-KS11247 | 44           | 10 x 10   | 0.8   | 13.2                  | 13.2 | 10.0 | 10.0 | 12.0    | 12.0    | IC248-0444-001 |
| IC51-0444-798    | 44           | 10 x 10   | 0.8   | 13.9                  | 13.9 | 10.0 | 10.0 | 12.9    | 12.9    |                |
| IC51-0444-615    | 44           | 14 x 14   | 1.0   | 17.2                  | 17.2 | 14.0 | 14.0 | 15.8    | 15.8    |                |
| IC51-621-KS8966  | 44           | 14 x 14   | 1.0   | 17.9                  | 17.9 | 14.0 | 14.0 | 16.5    | 16.5    |                |
| IC51-0484-806    | 48           | 7 x 7     | 0.5   | 9.0                   | 9.0  | 7.0  | 7.0  | 8.2     | 8.2     | Floating Base  |
| IC51-0484-081    | 48           | 12 x 12   | 0.8   | 15.3                  | 15.3 | 12.0 | 12.0 | 14.0    | 14.0    |                |

\*Note: New tooling part number.

QFP, PQFP, TQFP (Clamshell)

# IC51 Series

(Reference Only)

| Part Number       | No. of Leads | Body Size | Pitch | Matching Package Size |      |      |      |         |         | Notes                     |
|-------------------|--------------|-----------|-------|-----------------------|------|------|------|---------|---------|---------------------------|
|                   |              |           |       | A                     | B    | C    | D    | E (Max) | F (Max) |                           |
| IC51-0484-630     | 48           | 12 x 12   | 0.8   | 16.9                  | 16.9 | 12.0 | 12.0 | 15.0    | 15.0    |                           |
| IC51-0484-831-2   | 48           | 14 x 14   | 1.0   | 17.2                  | 17.2 | 14.0 | 14.0 | 15.8    | 15.8    |                           |
| IC51-0484-831-1   | 48           | 14 x 14   | 1.0   | 17.9                  | 17.9 | 14.0 | 14.0 | 16.8    | 16.8    |                           |
| IC51-0524-1612    | 52           | 10 X 10   | 0.65  | 12.0                  | 12.0 | 10.0 | 10.0 | 11.2    | 11.2    | Handmade                  |
| IC51-0564-680     | 56           | 10 X 10   | 0.65  | 13.2                  | 13.2 | 10.0 | 10.0 | 11.8    | 11.8    |                           |
| IC51-0564-924     | 56           | 10 X 14   | 0.8   | 13.2                  | 17.2 | 10.0 | 14.0 | 11.8    | 15.8    |                           |
| IC51-0564-790     | 56           | 16 X 20   | 1.0   | 19.2                  | 23.2 | 16.0 | 20.0 | 17.7    | 21.8    |                           |
| IC51-0564-1056    | 56           | 10 X 10   | 0.7   | 13.2                  | 13.2 | 10.0 | 10.0 | 11.8    | 11.8    |                           |
| IC51-0604-468     | 60           | 14 X 14   | 0.8   | 17.2                  | 17.2 | 14.0 | 14.0 | 15.8    | 15.8    |                           |
| IC51-0604-104     | 60           | 14 X 14   | 0.8   | 17.9                  | 17.9 | 14.0 | 14.0 | 16.4    | 16.4    |                           |
| IC51-0604-291     | 60           | 14 X 14   | 0.8   | 17.9                  | 17.9 | 14.0 | 14.0 | 16.7    | 16.7    | w/ Separator              |
| IC51-0604-497-2   | 60           | 16 X 20   | 1.0   | 17.9                  | 23.9 | 16.0 | 20.0 | 17.0    | 23.0    |                           |
| IC51-0644-807     | 64           | 10 X 10   | 0.5   | 12.0                  | 12.0 | 10.0 | 10.0 | 11.3    | 11.3    | FB lidless IC201-0644-003 |
| IC51-0644-1586    | 64           | 12 X 12   | 0.65  | 15.3                  | 15.3 | 12.0 | 12.0 | 13.9    | 13.9    | Floating Base / Lidless   |
| IC51-1240-AC03026 | 64           | 14 X 14   | 0.8   | 16.0                  | 16.0 | 14.0 | 14.0 | 15.3    | 15.3    |                           |
| IC51-0644-824-3   | 64           | 14 X 14   | 0.8   | 16.2                  | 16.2 | 14.0 | 14.0 | 15.4    | 15.4    |                           |
| IC51-0644-824-1   | 64           | 14 X 14   | 0.8   | 17.2                  | 17.2 | 14.0 | 14.0 | 15.8    | 15.8    |                           |
| IC51-0644-824-2   | 64           | 14 X 14   | 0.8   | 17.9                  | 17.9 | 14.0 | 14.0 | 16.7    | 16.7    |                           |
| IC51-0644-824-5   | 64           | 14 X 14   | 0.8   | 16.0                  | 16.0 | 14.0 | 14.0 | 15.2    | 15.2    |                           |
| IC51-0644-820-2   | 64           | 14 X 20   | 1.0   | 17.6                  | 23.6 | 14.0 | 20.0 | 16.3    | 22.3    |                           |
| IC51-820-2-KS9376 | 64           | 14 X 20   | 1.0   | 17.9                  | 23.9 | 14.0 | 20.0 | 16.8    | 22.8    | Lidless IC201-0644-019    |
| IC51-0644-820-1   | 64           | 14 X 20   | 1.0   | 18.7                  | 24.7 | 14.0 | 20.0 | 17.0    | 23.0    |                           |
| IC51-0684-734     | 68           | 10 X 14   | 0.65  | 13.2                  | 17.2 | 10.0 | 14.0 | 11.8    | 15.8    |                           |
| IC51-0684-730     | 68           | 27 X 27   | 1.27  | 30.0                  | 30.0 | 27.0 | 27.0 | 27.5    | 27.5    | Handmade w/ Separator     |
| IC51-0724-119     | 72           | 16 X 20   | 0.8   | 18.0                  | 23.0 | 16.0 | 20.0 | 16.6    | 21.5    |                           |
| IC51-0724-698     | 73           | 16 X 20   | 0.8   | 18.2                  | 23.1 | 16.0 | 20.0 | 16.5    | 21.4    |                           |
| IC51-0804-808     | 80           | 12 X 12   | 0.5   | 14.0                  | 14.0 | 12.0 | 12.0 | 13.3    | 13.3    | FB IC201-0804-014         |
| IC51-0804-795     | 80           | 14 X 14   | 0.65  | 16.0                  | 16.0 | 14.0 | 14.0 | 15.3    | 15.3    |                           |
| IC51-0804-711     | 80           | 14 X 14   | 0.65  | 17.2                  | 17.2 | 14.0 | 14.0 | 15.8    | 15.8    |                           |
| IC51-0804-956-2   | 80           | 14 X 14   | 0.65  | 17.2                  | 17.2 | 14.0 | 14.0 | 16.0    | 16.0    | IC149-080-017-S5          |
| IC51-0804-819-6   | 80           | 14 X 20   | 0.8   | 17.2                  | 23.2 | 14.0 | 20.0 | 15.8    | 21.8    |                           |
| IC51-819-KS12720  | 80           | 14 X 20   | 0.8   | 17.2                  | 23.2 | 14.0 | 20.0 | 16.3    | 22.3    | IC201-0804-032            |
| IC51-0804-819-2   | 80           | 14 X 20   | 0.8   | 17.6                  | 23.6 | 14.0 | 20.0 | 16.3    | 22.3    |                           |
| IC51-0804-819-1   | 80           | 14 X 20   | 0.8   | 17.9                  | 23.9 | 14.0 | 20.0 | 16.8    | 22.8    | Lidless IC201-0804-005    |
| IC51-0884-999     | 88           | 20 X 20   | 0.8   | 23.0                  | 23.0 | 20.0 | 20.0 | 22.3    | 22.3    |                           |
| IC51-0884-1290    | 88           | 12 X 12   | 0.5   | 14.0                  | 14.0 | 12.0 | 12.0 | 13.3    | 13.3    | FB                        |
| IC51-1004-809     | 100          | 14 X 14   | 0.5   | 16.0                  | 16.0 | 14.0 | 14.0 | 15.2    | 15.2    | Lidless IC201-1004-008    |
| IC51-1004-814-6   | 100          | 14 X 20   | 0.7   | 17.2                  | 23.2 | 14.0 | 20.0 | 15.8    | 21.8    |                           |
| IC51-1004-814-13  | 100          | 14 X 20   | 0.65  | 16.0                  | 22.0 | 14.0 | 20.0 | 15.2    | 21.2    |                           |
| IC51-814-KS12033  | 100          | 14 X 20   | 0.65  | 17.2                  | 23.2 | 14.0 | 20.0 | 16.4    | 22.4    | Lidless IC201-1004-028    |

Quad Flat Packages

# QFP, PQFP, TQFP (Clamshell)

## IC51 Series

(Reference Only)

| Part Number        | No. of Leads | Body Size   | Pitch | Matching Package Size |       |       |       |         |         | Notes                     |
|--------------------|--------------|-------------|-------|-----------------------|-------|-------|-------|---------|---------|---------------------------|
|                    |              |             |       | A                     | B     | C     | D     | E (Max) | F (Max) |                           |
| IC51-1004-814-2    | 100          | 14 x 20     | 0.65  | 17.6                  | 23.6  | 14.0  | 20.0  | 16.4    | 22.4    |                           |
| IC51-1004-814-1    | 100          | 14 x 20     | 0.65  | 17.9                  | 23.9  | 14.0  | 20.0  | 17.0    | 23.0    | FB/Lidless IC201-1004-016 |
| IC51-1004-567      | 100          | 22 x 22     | 0.8   | 27.8                  | 27.8  | 22.0  | 22.0  | 25.8    | 25.8    | Dead Bug Loading          |
| IC51-1124-1036-2   | 112          | 20 x 20     | 0.65  | 23.3                  | 23.3  | 20.0  | 20.0  | 22.3    | 22.3    |                           |
| IC51-1204-1812     | 120          | 14 x 14     | 0.4   | 16.0                  | 16.0  | 14.0  | 14.0  | 15.2    | 15.2    | Floating Base             |
| IC51-1204-1497     | 120          | 28 x 28     | 0.8   | 31.2                  | 31.2  | 28.0  | 28.0  | 30.0    | 30.0    |                           |
| IC51-1204-1646     | 120          | 28 x 28     | 0.8   | 32.0                  | 32.0  | 28.0  | 28.0  | 30.8    | 30.8    |                           |
| IC51-1204-1652     | 120          | 16 x 16     | 0.5   | 18.4                  | 18.4  | 16.0  | 16.0  | 17.5    | 17.5    | FB/IC201-1204-017         |
| IC51-1497-KS11444  | 120          | 28 x 28     | 0.8   | 31.9                  | 31.9  | 28.0  | 28.0  | 30.5    | 30.5    |                           |
| IC51-1284-844-3    | 128          | 28 x 28     | 0.8   | 31.9                  | 31.9  | 28.0  | 28.0  | 30.6    | 30.6    | w/Separator               |
| IC51-1284-1433     | 128          | 14 x 20     | 0.5   | 16.0                  | 22.0  | 14.0  | 20.0  | 15.0    | 21.0    | Floating Base / TQFP      |
| IC51-1284-1433-10  | 128          | 14 x 20     | 0.5   | 17.2                  | 23.2  | 14.0  | 20.0  | 16.4    | 22.4    | Floating Base             |
| IC51-1284-1788     | 128          | 14 x 14     | 0.4   | 16.0                  | 16.0  | 14.0  | 14.0  | 15.3    | 15.3    | Floating Base             |
| IC51-1284-976-2    | 128          | 28 x 28     | 0.80  | 31.2                  | 31.2  | 28.0  | 28.0  | 30.0    | 30.0    |                           |
| IC51-1284-976-1    | 128          | 28 x 28     | 0.80  | 31.9                  | 31.9  | 28.0  | 28.0  | 30.5    | 30.5    | Lidless IC200-1284-001    |
| IC51-1444-1354     | 144          | 20 x 20     | 0.5   | 22.0                  | 22.0  | 20.0  | 20.0  | 21.2    | 21.2    | Floating Base             |
| IC51-1444-1354-7   | 144          | 20 x 20     | 0.5   | 22.0                  | 22.0  | 20.0  | 20.0  | 21.3    | 21.3    | Floating Base / TQFP      |
| IC51-1354-KS11590  | 144          | 20 x 20     | 0.5   | 23.2                  | 23.2  | 22.0  | 22.0  | 22.3    | 22.3    | Floating Base             |
| IC51-1444-1014-3   | 144          | 28 x 28     | 0.65  | 31.2                  | 31.2  | 28.0  | 28.0  | 30.4    | 30.4    |                           |
| IC51-1014-KS11225  | 144          | 28 x 28     | 0.65  | 31.6                  | 31.6  | 28.0  | 28.0  | 30.6    | 30.6    |                           |
| IC51-1014-KS12626  | 144          | 28 x 28     | 0.65  | 32.0                  | 32.0  | 28.0  | 28.0  | 31.0    | 31.0    |                           |
| IC51-1505-AC07095  | 160          | 24 x 24     | 0.50  | 26.0                  | 26.0  | 24.0  | 24.0  | 25.3    | 25.3    | SFB / TQFB                |
| IC51-1604-1350     | 160          | 24 x 24     | 0.50  | 26.0                  | 26.0  | 24.0  | 24.0  | 25.2    | 25.2    | Floating Base             |
| IC51-1604-1350-2   | 160          | 24 x 24     | 0.5   | 26.0                  | 26.0  | 24.0  | 24.0  | 25.3    | 25.3    | Floating Base / TQFP      |
| IC51-1604-845-4    | 160          | 28 x 28     | 0.65  | 31.2                  | 31.2  | 28.0  | 28.0  | 30.0    | 30.0    | Lidless IC201-1604-006    |
| IC51-1604-845-1    | 160          | 28 x 28     | 0.65  | 31.9                  | 31.9  | 28.0  | 28.0  | 30.5    | 30.5    |                           |
| IC51-1764-1995-6   | 176          | 20 x 20     | 0.4   | 22.0                  | 22.0  | 20.0  | 20.0  | 21.2    | 21.2    | Floating Base / TQFP      |
| IC51-1764-1505     | 176          | 24 x 24     | 0.5   | 26.0                  | 26.0  | 24.0  | 24.0  | 25.3    | 25.3    | Floating Base             |
| IC51-1764-1505-5   | 176          | 24 x 24     | 0.5   | 26.0                  | 26.0  | 24.0  | 24.0  | 25.3    | 25.3    | Floating Base / TQFP      |
| IC51-1844-1148-1   | 184          | 32 x 32     | 0.65  | 35.2                  | 35.2  | 32.0  | 32.0  | 33.7    | 33.7    | Floating Base             |
| IC51-1844-1541     | 184          | 32 x 32     | 0.65  | 35.75                 | 35.75 | 32.0  | 32.0  | 34.0    | 34.0    | Floating Base             |
| IC51-1964-1952     | 196          | 32.29x32.29 | 0.64  | —                     | —     | 32.3  | 32.3  | 56.5    | 56.5    | NCTB                      |
| IC51-2084-1052-* † | 208          | 28 x 28     | 0.5   | —                     | —     | 28.0  | 28.0  | —       | —       | Floating Base             |
| IC51-2084-1509     | 208          | 28 x 28     | 0.5   | 30.6                  | 30.6  | 28.0  | 28.0  | 29.9    | 29.9    | MQUAD®                    |
| IC51-2404-1655-2   | 240          | 32 x 32     | 0.5   | 34.6                  | 34.6  | 32.0  | 32.0  | 33.8    | 33.8    | Floating Base             |
| IC51-2404-1655-3   | 240          | 32 x 32     | 0.5   | 34.6                  | 34.6  | 31.6  | 31.6  | 33.7    | 33.7    | Floating Base / TQFP      |
| IC51-2404-1655-4   | 240          | 32 x 32     | 0.5   | 34.0                  | 34.0  | 32.0  | 32.0  | 33.4    | 33.4    | Floating Base / TQFP      |
| IC51-2564-1668     | 256          | 28 x 28     | 0.4   | 30.6                  | 30.6  | 28.0  | 28.0  | 29.9    | 29.9    | Floating Base             |
| IC51-2564-1668-9   | 256          | 28 x 28     | 0.4   | 30.6                  | 30.6  | 28.0  | 28.0  | 29.4    | 29.4    | Floating Base             |
| IC51-2564-1668-10  | 256          | 28 x 28     | 0.4   | 30.0                  | 30.0  | 28.0  | 28.0  | 29.4    | 29.4    | Floating Base / TQFP      |
| IC51-2564-1668-15  | 256          | 28 x 28     | 0.4   | 30.0                  | 30.0  | 28.0  | 28.0  | 29.2    | 29.2    | Floating Base / TQFP      |
| QFP12T256-001      | 256          | 42 x 42     | 0.5   | 46.4                  | 46.4  | 42.0  | 42.0  | 45.0    | 45.0    | MQUAD®                    |
| IC51-2724-1727     | 272          | 36 x 36     | 0.5   | 39.9                  | 39.9  | 36.0  | 36.0  | 37.6    | 37.6    | Floating Base             |
| IC51-3044-1471-2   | 304          | 40 x 40     | 0.5   | 42.6                  | 42.6  | 40.0  | 40.0  | 41.6    | 41.6    | Lidless IC201-3044-004    |
| IC51-3044-1471-5   | 304          | 40 x 40     | 0.5   | 42.6                  | 42.6  | 39.64 | 39.64 | 41.9    | 41.9    | MQUAD®                    |

FB = Floating Base

† = We have many variations of this product. Please contact our salespersons for further details.

This information is for reference only. We recommend actual check of package for any socket with a Floating Base before ordering.

MQUAD® is a Registered Trademark of Olin Corp.

For detailed drawings or information please contact our sales office at (408) 456-0797.

# PC BOARD LAYOUTS

*QFP, PQFP, TQFP (Clamshell)*

## IC51 Series

**IC51-0324-805 (32 Pins)**

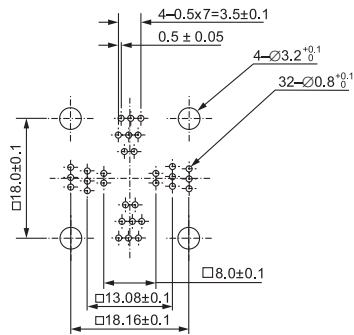

**IC51-0324-1498 (32 Pins)**

**IC51-0324-354 (32 Pins)**

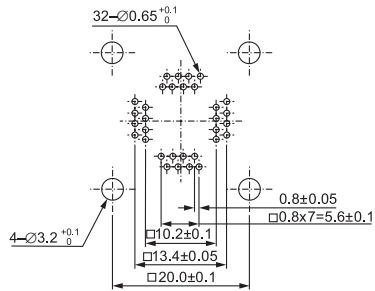

**IC51-0444-1195-3 (44 Pins)**

**IC51-0444-825 (44 Pins)**

**IC51-467-KS11247 (44 Pins)**

**IC51-467-KS11787 (44 Pins)**

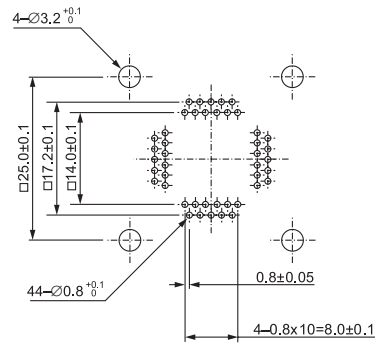

Quad Flat Packages

QFP, PQFP, TQFP (Clamshell)

# PC BOARD LAYOUTS

## IC51 Series

IC51-0444-798 (44 Pins)

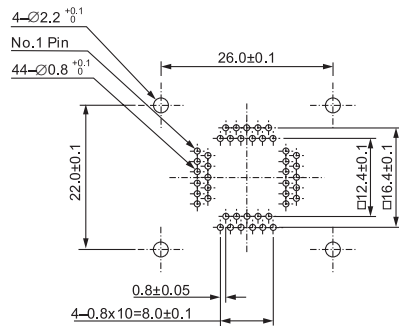

IC51-0484-806 (48 Pins)

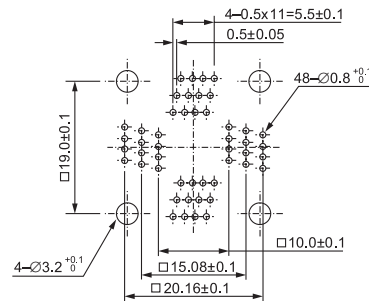

IC51-0444-615 (44 Pins)

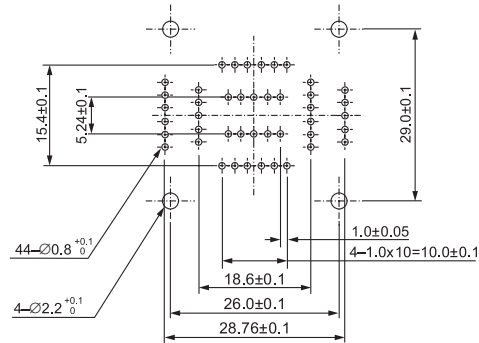

# PC BOARD LAYOUTS

**QFP, PQFP, TQFP (Clamshell)**

## IC51 Series

**IC51-0484-081 (48 Pins)**

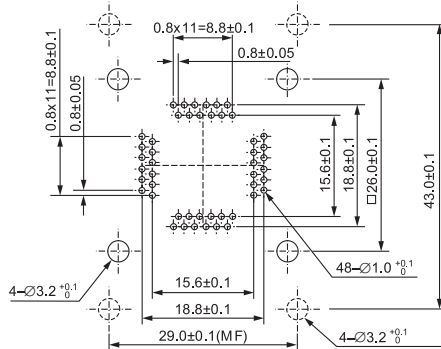

**IC51-0564-924 (56 Pins)**

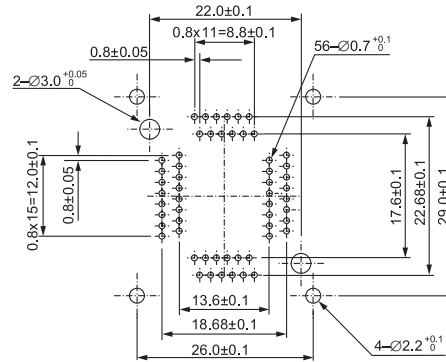

**IC51-0564-680 (56 Pins)**

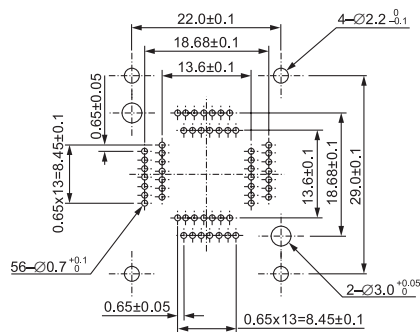

**IC51-0564-790 (56 Pins)**

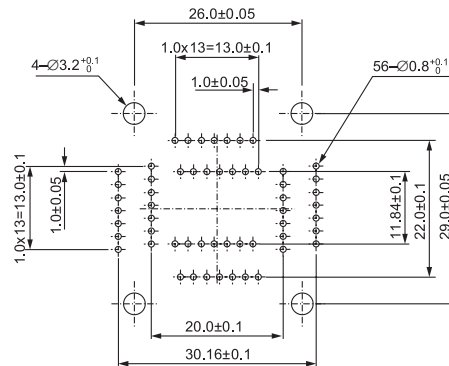

Quad Flat Packages

**QFP, PQFP, TQFP (Clamshell)**

# IC51 Series

## PC BOARD LAYOUTS

**IC51-1004-809 (100 Pins)**

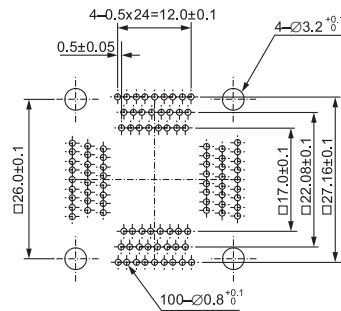

**IC51-1004-567 (100 Pins)**

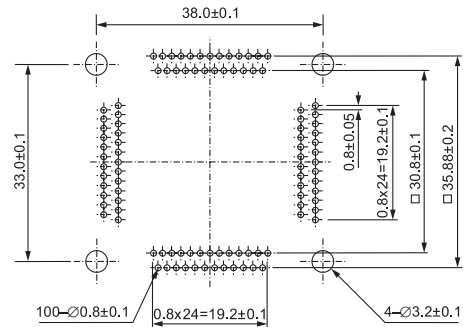

**IC51-1124-1036-2 (112 Pins)**

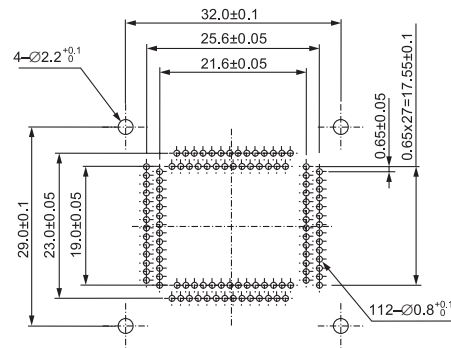

**IC51-1004-814-1 (100 Pins)**

**IC51-1004-814-2 (100 Pins)**

**IC51-1004-814-13 (100 Pins)**

**IC51-814-KS12033 (100 Pins)**

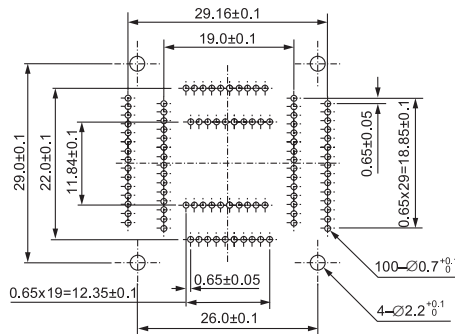

**IC51-1204-1812 (120 Pins)**

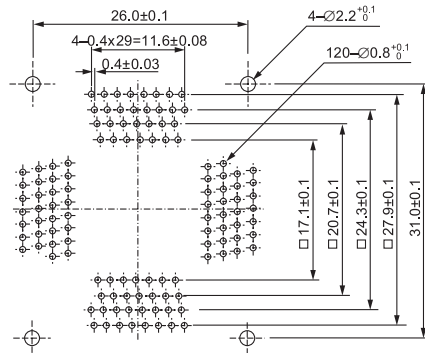

# PC BOARD LAYOUTS

*QFP, PQFP, TQFP (Clamshell)*

## IC51 Series

**IC51-0644-692** (64 Pins)

**IC51-0644-824-1** (64 Pins)

**IC51-0644-824-2** (64 Pins)

**IC51-0644-824-3** (64 Pins)

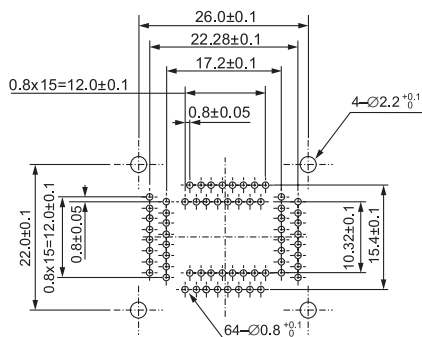

**IC51-0684-734** (68 Pins)

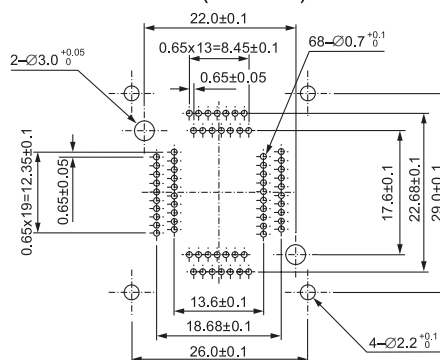

**IC51-0644-472** (64 Pins)

**IC51-0644-820-1** (64 Pins)

**IC51-0644-820-2** (64 Pins)

**IC51-0644-820-4** (64 Pins)

**IC51-820-2-KS9376** (64 Pins)

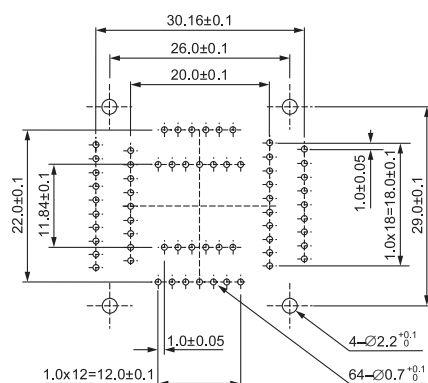

**IC51-0724-698** (72 Pins)

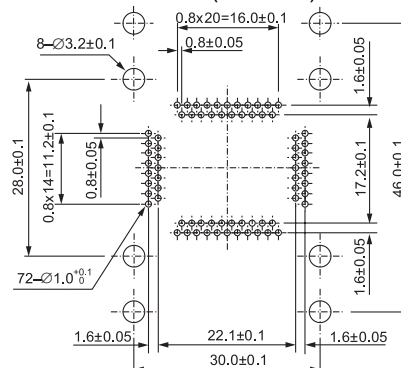

Quad Flat  
Packages



# IC51 Series

IC51-0804-808 (80 Pins)

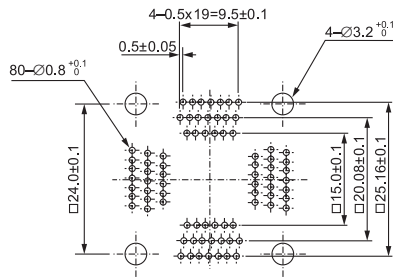

IC51-0804-795 (80 Pins)

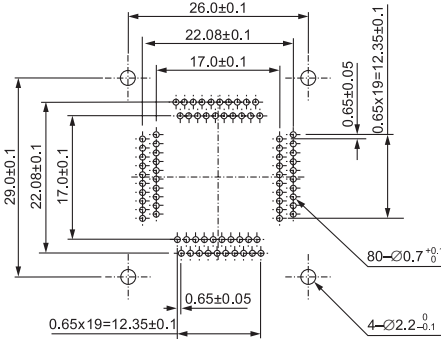

IC51-0804-711 (80 Pins)

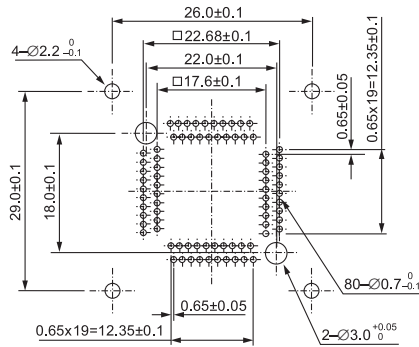

IC51-0804-819-1 (80 Pins)

IC51-0804-819-2 (80 Pins)

IC51-0804-819-8 (80 Pins)

IC51-819-KS12720 (80 Pins)

IC51-0804-956-2 (80 Pins)

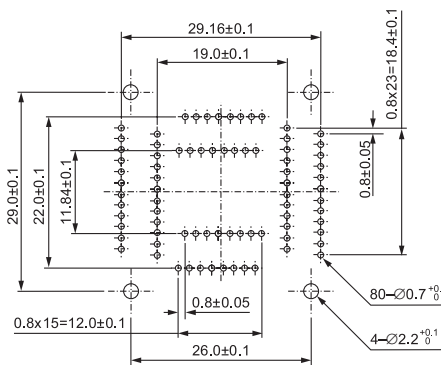
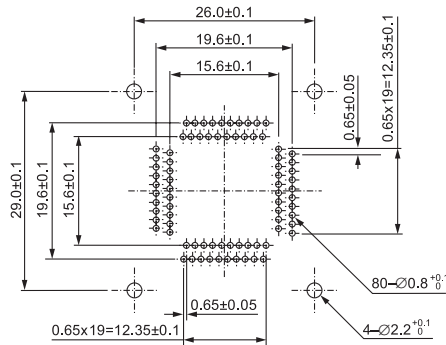

# PC BOARD LAYOUTS

*QFP, PQFP, TQFP (Clamshell)*

## **IC51 Series**

Quad Flat  
Packages

# IC51 Series

IC51-1204-1652 (120 Pins)

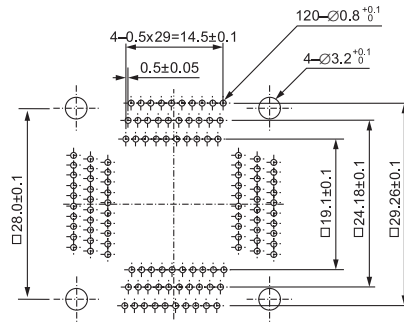

IC51-1284-1433 (128 Pins)  
IC51-1284-1433-10 (128 Pins)

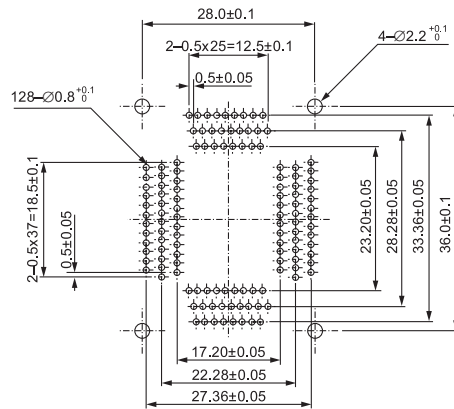

IC51-1497-KS11444 (120 Pins)  
IC51-1204-1497 (120 Pins)

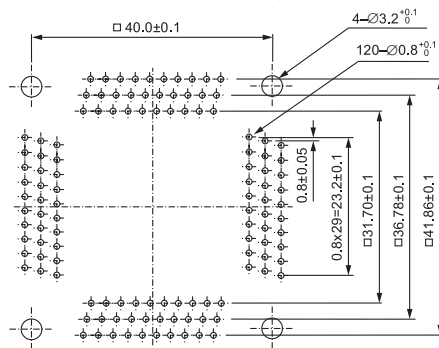

IC51-1284-844-1 (128 Pins)  
IC51-1284-976-1 (128 Pins)  
IC51-1284-976-2 (128 Pins)  
IC51-844-KS13329 (128 Pins)

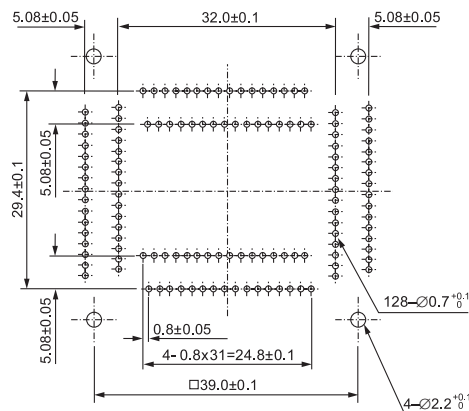

# PC BOARD LAYOUTS

**QFP, PQFP, TQFP (Clamshell)**

## IC51 Series

**IC51-1444-1354** (144 Pins)

**IC51-1444-1354-7** (144 Pins)

**IC51-1354-KS11590** (144 Pins)

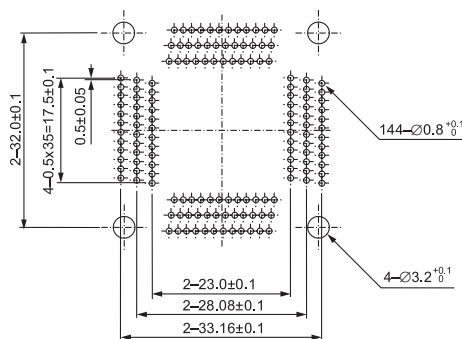

**IC51-1604-1350** (160 Pins)

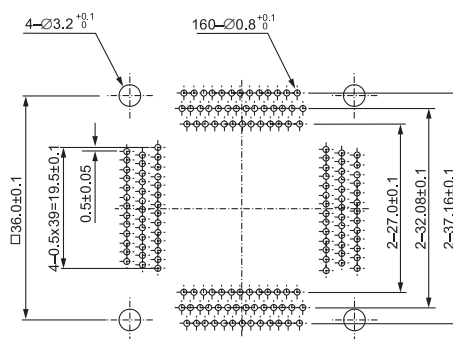

**IC51-1444-1014** (144 Pins)

**IC51-1444-1014-3** (144 Pins)

**IC51-1014-KS11137** (144 Pins)

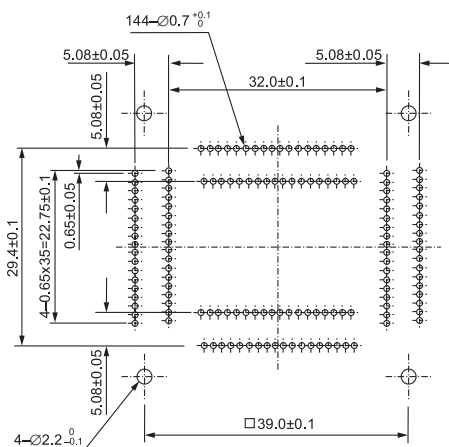

**IC51-1604-845-1** (160 Pins)

**IC51-1604-845-4** (160 Pins)

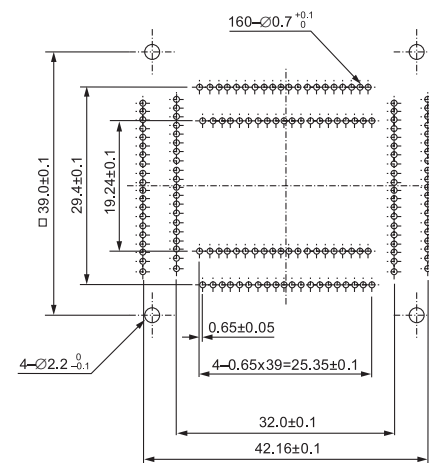

Quad Flat  
Packages

# IC51 Series

## PC BOARD LAYOUTS

IC51-1764-1505 (176 Pins)

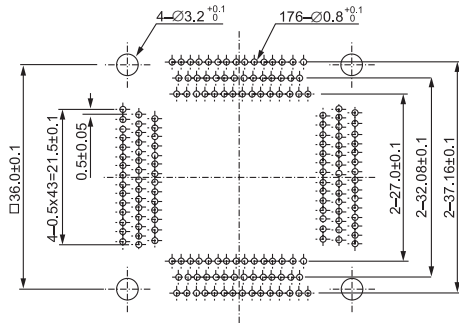

IC51-2084-1052-\*<sup>1)</sup> (208 Pins)  
IC51-2084-1509 (208 Pins)

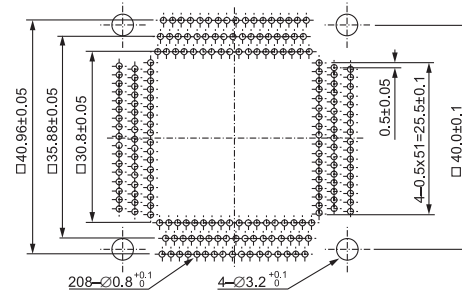

\*<sup>1)</sup> for type: -1, -2, -3, -5, -6, -7, -9 and -11

IC51-1844-1148-1 (184 Pins)

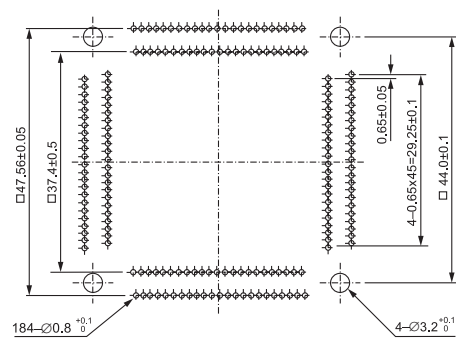

IC51-2084-1052-\*<sup>2)</sup> (208 Pins)

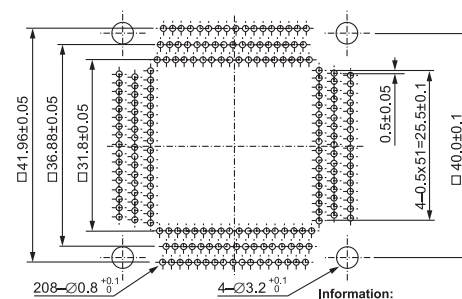

\*<sup>2)</sup> for type: -4, -8 and -13

**Information:**  
We have many variations of this product. Please contact our sales staff for further details.

IC51-1844-1541 (184 Pins)

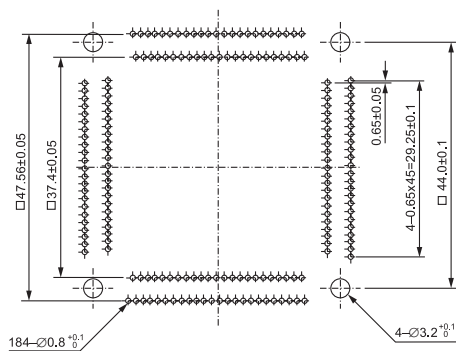

IC51-2404-1655-2 (240 Pins)  
IC51-2404-1655-3 (240 Pins)

