

QFP, PQFP, TQFP (Clamshell)

IC51 Series

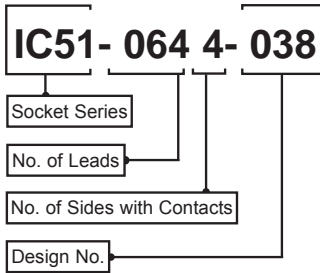

Characteristics

Insulation Resistance: 1,000M Ω minimum at 500 VDC
 Withstanding Voltage: 700 VAC for 1 minute
 Contact Resistance: 30m Ω max. at 10mA/20mV (Initial)
 Operating Temperature: PES/PEI -55°C ~ +170°C
 PSF -40°C ~ +150°C

Material

Insulator: PSF / PES / PEI
 Contact: Beryllium Copper
 Plating: Gold over Nickel

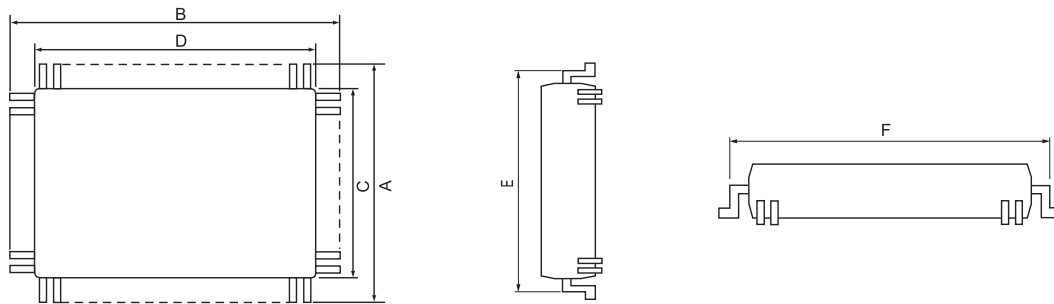

(Reference Only)

Part Number	No. of Leads	Body Size	Pitch	Matching Package Size						Notes
				A	B	C	D	E (Max)	F (Max)	
IC51-0324-805	32	5 x 5	0.5	7.0	7.0	5.0	5.0	6.2	6.2	Floating Base
IC51-0324-354	32	7 x 7	0.8	9.0	9.0	7.0	7.0	8.4	8.4	
IC51-0324-1498	32	7 x 7	0.8	9.0	9.0	7.0	7.0	8.4	8.4	
QFP11T044-001*	44	10 x 10	0.8	12.0	12.0	10.0	10.0	11.3	11.3	
IC51-0444-1195-3	44	10 x 10	0.8	12.6	12.6	10.0	10.0	11.5	11.5	
IC51-0444-825	44	10 x 10	0.8	12.6	12.6	10.0	10.0	11.7	11.7	
IC51-467-KS11247	44	10 x 10	0.8	13.2	13.2	10.0	10.0	12.0	12.0	IC248-0444-001
IC51-0444-798	44	10 x 10	0.8	13.9	13.9	10.0	10.0	12.9	12.9	
IC51-0444-615	44	14 x 14	1.0	17.2	17.2	14.0	14.0	15.8	15.8	
IC51-621-KS8966	44	14 x 14	1.0	17.9	17.9	14.0	14.0	16.5	16.5	
IC51-0484-806	48	7 x 7	0.5	9.0	9.0	7.0	7.0	8.2	8.2	Floating Base
IC51-0484-081	48	12 x 12	0.8	15.3	15.3	12.0	12.0	14.0	14.0	

*Note: New tooling part number.

QFP, PQFP, TQFP (Clamshell)

IC51 Series

(Reference Only)

Part Number	No. of Leads	Body Size	Pitch	Matching Package Size						Notes
				A	B	C	D	E (Max)	F (Max)	
IC51-0484-630	48	12 x 12	0.8	16.9	16.9	12.0	12.0	15.0	15.0	
IC51-0484-831-2	48	14 x 14	1.0	17.2	17.2	14.0	14.0	15.8	15.8	
IC51-0484-831-1	48	14 x 14	1.0	17.9	17.9	14.0	14.0	16.8	16.8	
IC51-0524-1612	52	10 X 10	0.65	12.0	12.0	10.0	10.0	11.2	11.2	Handmade
IC51-0564-680	56	10 X 10	0.65	13.2	13.2	10.0	10.0	11.8	11.8	
IC51-0564-924	56	10 X 14	0.8	13.2	17.2	10.0	14.0	11.8	15.8	
IC51-0564-790	56	16 X 20	1.0	19.2	23.2	16.0	20.0	17.7	21.8	
IC51-0564-1056	56	10 X 10	0.7	13.2	13.2	10.0	10.0	11.8	11.8	
IC51-0604-468	60	14 X 14	0.8	17.2	17.2	14.0	14.0	15.8	15.8	
IC51-0604-104	60	14 X 14	0.8	17.9	17.9	14.0	14.0	16.4	16.4	
IC51-0604-291	60	14 X 14	0.8	17.9	17.9	14.0	14.0	16.7	16.7	w/ Separator
IC51-0604-497-2	60	16 X 20	1.0	17.9	23.9	16.0	20.0	17.0	23.0	
IC51-0644-807	64	10 X 10	0.5	12.0	12.0	10.0	10.0	11.3	11.3	FB lidless IC201-0644-003
IC51-0644-1586	64	12 X 12	0.65	15.3	15.3	12.0	12.0	13.9	13.9	Floating Base / Lidless
IC51-1240-AC03026	64	14 X 14	0.8	16.0	16.0	14.0	14.0	15.3	15.3	
IC51-0644-824-3	64	14 X 14	0.8	16.2	16.2	14.0	14.0	15.4	15.4	
IC51-0644-824-1	64	14 X 14	0.8	17.2	17.2	14.0	14.0	15.8	15.8	
IC51-0644-824-2	64	14 X 14	0.8	17.9	17.9	14.0	14.0	16.7	16.7	
IC51-0644-824-5	64	14 X 14	0.8	16.0	16.0	14.0	14.0	15.2	15.2	
IC51-0644-820-2	64	14 X 20	1.0	17.6	23.6	14.0	20.0	16.3	22.3	
IC51-820-2-KS9376	64	14 X 20	1.0	17.9	23.9	14.0	20.0	16.8	22.8	Lidless IC201-0644-019
IC51-0644-820-1	64	14 X 20	1.0	18.7	24.7	14.0	20.0	17.0	23.0	
IC51-0684-734	68	10 X 14	0.65	13.2	17.2	10.0	14.0	11.8	15.8	
IC51-0684-730	68	27 X 27	1.27	30.0	30.0	27.0	27.0	27.5	27.5	Handmade w/ Separator
IC51-0724-119	72	16 X 20	0.8	18.0	23.0	16.0	20.0	16.6	21.5	
IC51-0724-698	73	16 X 20	0.8	18.2	23.1	16.0	20.0	16.5	21.4	
IC51-0804-808	80	12 X 12	0.5	14.0	14.0	12.0	12.0	13.3	13.3	FB IC201-0804-014
IC51-0804-795	80	14 X 14	0.65	16.0	16.0	14.0	14.0	15.3	15.3	
IC51-0804-711	80	14 X 14	0.65	17.2	17.2	14.0	14.0	15.8	15.8	
IC51-0804-956-2	80	14 X 14	0.65	17.2	17.2	14.0	14.0	16.0	16.0	IC149-080-017-S5
IC51-0804-819-6	80	14 X 20	0.8	17.2	23.2	14.0	20.0	15.8	21.8	
IC51-819-KS12720	80	14 X 20	0.8	17.2	23.2	14.0	20.0	16.3	22.3	IC201-0804-032
IC51-0804-819-2	80	14 X 20	0.8	17.6	23.6	14.0	20.0	16.3	22.3	
IC51-0804-819-1	80	14 X 20	0.8	17.9	23.9	14.0	20.0	16.8	22.8	Lidless IC201-0804-005
IC51-0884-999	88	20 X 20	0.8	23.0	23.0	20.0	20.0	22.3	22.3	
IC51-0884-1290	88	12 X 12	0.5	14.0	14.0	12.0	12.0	13.3	13.3	FB
IC51-1004-809	100	14 X 14	0.5	16.0	16.0	14.0	14.0	15.2	15.2	Lidless IC201-1004-008
IC51-1004-814-6	100	14 X 20	0.7	17.2	23.2	14.0	20.0	15.8	21.8	
IC51-1004-814-13	100	14 X 20	0.65	16.0	22.0	14.0	20.0	15.2	21.2	
IC51-814-KS12033	100	14 X 20	0.65	17.2	23.2	14.0	20.0	16.4	22.4	Lidless IC201-1004-028

Quad Flat Packages

QFP, PQFP, TQFP (Clamshell)

IC51 Series

(Reference Only)

Part Number	No. of Leads	Body Size	Pitch	Matching Package Size						Notes
				A	B	C	D	E (Max)	F (Max)	
IC51-1004-814-2	100	14 x 20	0.65	17.6	23.6	14.0	20.0	16.4	22.4	
IC51-1004-814-1	100	14 x 20	0.65	17.9	23.9	14.0	20.0	17.0	23.0	FB/Lidless IC201-1004-016
IC51-1004-567	100	22 x 22	0.8	27.8	27.8	22.0	22.0	25.8	25.8	Dead Bug Loading
IC51-1124-1036-2	112	20 x 20	0.65	23.3	23.3	20.0	20.0	22.3	22.3	
IC51-1204-1812	120	14 x 14	0.4	16.0	16.0	14.0	14.0	15.2	15.2	Floating Base
IC51-1204-1497	120	28 x 28	0.8	31.2	31.2	28.0	28.0	30.0	30.0	
IC51-1204-1646	120	28 x 28	0.8	32.0	32.0	28.0	28.0	30.8	30.8	
IC51-1204-1652	120	16 x 16	0.5	18.4	18.4	16.0	16.0	17.5	17.5	FB/IC201-1204-017
IC51-1497-KS11444	120	28 x 28	0.8	31.9	31.9	28.0	28.0	30.5	30.5	
IC51-1284-844-3	128	28 x 28	0.8	31.9	31.9	28.0	28.0	30.6	30.6	w/Separator
IC51-1284-1433	128	14 x 20	0.5	16.0	22.0	14.0	20.0	15.0	21.0	Floating Base / TQFP
IC51-1284-1433-10	128	14 x 20	0.5	17.2	23.2	14.0	20.0	16.4	22.4	Floating Base
IC51-1284-1788	128	14 x 14	0.4	16.0	16.0	14.0	14.0	15.3	15.3	Floating Base
IC51-1284-976-2	128	28 x 28	0.80	31.2	31.2	28.0	28.0	30.0	30.0	
IC51-1284-976-1	128	28 x 28	0.80	31.9	31.9	28.0	28.0	30.5	30.5	Lidless IC200-1284-001
IC51-1444-1354	144	20 x 20	0.5	22.0	22.0	20.0	20.0	21.2	21.2	Floating Base
IC51-1444-1354-7	144	20 x 20	0.5	22.0	22.0	20.0	20.0	21.3	21.3	Floating Base / TQFP
IC51-1354-KS11590	144	20 x 20	0.5	23.2	23.2	22.0	22.0	22.3	22.3	Floating Base
IC51-1444-1014-3	144	28 x 28	0.65	31.2	31.2	28.0	28.0	30.4	30.4	
IC51-1014-KS11225	144	28 x 28	0.65	31.6	31.6	28.0	28.0	30.6	30.6	
IC51-1014-KS12626	144	28 x 28	0.65	32.0	32.0	28.0	28.0	31.0	31.0	
IC51-1505-AC07095	160	24 x 24	0.50	26.0	26.0	24.0	24.0	25.3	25.3	SFB / TQFB
IC51-1604-1350	160	24 x 24	0.50	26.0	26.0	24.0	24.0	25.2	25.2	Floating Base
IC51-1604-1350-2	160	24 x 24	0.5	26.0	26.0	24.0	24.0	25.3	25.3	Floating Base / TQFP
IC51-1604-845-4	160	28 x 28	0.65	31.2	31.2	28.0	28.0	30.0	30.0	Lidless IC201-1604-006
IC51-1604-845-1	160	28 x 28	0.65	31.9	31.9	28.0	28.0	30.5	30.5	
IC51-1764-1995-6	176	20 x 20	0.4	22.0	22.0	20.0	20.0	21.2	21.2	Floating Base / TQFP
IC51-1764-1505	176	24 x 24	0.5	26.0	26.0	24.0	24.0	25.3	25.3	Floating Base
IC51-1764-1505-5	176	24 x 24	0.5	26.0	26.0	24.0	24.0	25.3	25.3	Floating Base / TQFP
IC51-1844-1148-1	184	32 x 32	0.65	35.2	35.2	32.0	32.0	33.7	33.7	Floating Base
IC51-1844-1541	184	32 x 32	0.65	35.75	35.75	32.0	32.0	34.0	34.0	Floating Base
IC51-1964-1952	196	32.29x32.29	0.64	—	—	32.3	32.3	56.5	56.5	NCTB
IC51-2084-1052-* †	208	28 x 28	0.5	—	—	28.0	28.0	—	—	Floating Base
IC51-2084-1509	208	28 x 28	0.5	30.6	30.6	28.0	28.0	29.9	29.9	MQUAD®
IC51-2404-1655-2	240	32 x 32	0.5	34.6	34.6	32.0	32.0	33.8	33.8	Floating Base
IC51-2404-1655-3	240	32 x 32	0.5	34.6	34.6	31.6	31.6	33.7	33.7	Floating Base / TQFP
IC51-2404-1655-4	240	32 x 32	0.5	34.0	34.0	32.0	32.0	33.4	33.4	Floating Base / TQFP
IC51-2564-1668	256	28 x 28	0.4	30.6	30.6	28.0	28.0	29.9	29.9	Floating Base
IC51-2564-1668-9	256	28 x 28	0.4	30.6	30.6	28.0	28.0	29.4	29.4	Floating Base
IC51-2564-1668-10	256	28 x 28	0.4	30.0	30.0	28.0	28.0	29.4	29.4	Floating Base / TQFP
IC51-2564-1668-15	256	28 x 28	0.4	30.0	30.0	28.0	28.0	29.2	29.2	Floating Base / TQFP
QFP12T256-001	256	42 x 42	0.5	46.4	46.4	42.0	42.0	45.0	45.0	MQUAD®
IC51-2724-1727	272	36 x 36	0.5	39.9	39.9	36.0	36.0	37.6	37.6	Floating Base
IC51-3044-1471-2	304	40 x 40	0.5	42.6	42.6	40.0	40.0	41.6	41.6	Lidless IC201-3044-004
IC51-3044-1471-5	304	40 x 40	0.5	42.6	42.6	39.64	39.64	41.9	41.9	MQUAD®

FB = Floating Base

† = We have many variations of this product. Please contact our salespersons for further details.

This information is for reference only. We recommend actual check of package for any socket with a Floating Base before ordering.

MQUAD® is a Registered Trademark of Olin Corp.

For detailed drawings or information please contact our sales office at (408) 456-0797.

PC BOARD LAYOUTS

QFP, PQFP, TQFP (Clamshell)

IC51 Series

IC51-0324-805 (32 Pins)

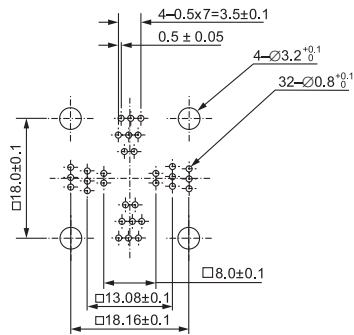

IC51-0324-1498 (32 Pins)

IC51-0324-354 (32 Pins)

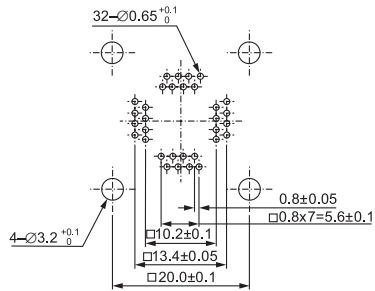

IC51-0444-1195-3 (44 Pins)

IC51-0444-825 (44 Pins)

IC51-467-KS11247 (44 Pins)

IC51-467-KS11787 (44 Pins)

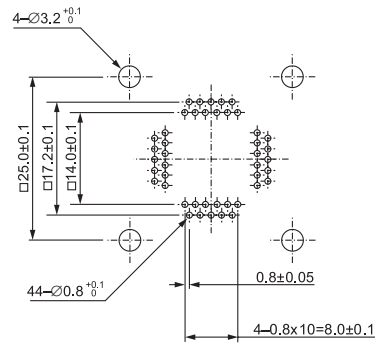

Quad Flat
Packages

QFP, PQFP, TQFP (Clamshell)

PC BOARD LAYOUTS

IC51 Series

IC51-0444-798 (44 Pins)

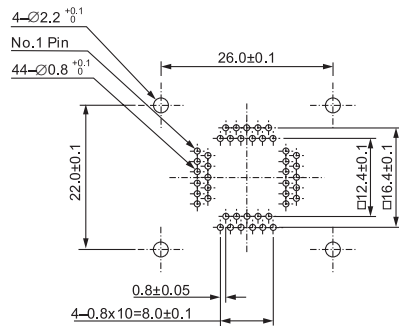

IC51-0484-806 (48 Pins)

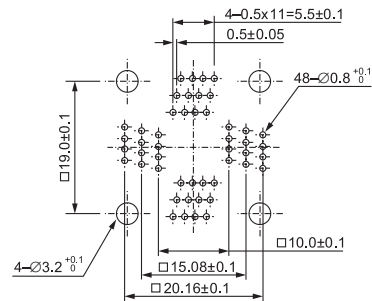

IC51-0444-615 (44 Pins)

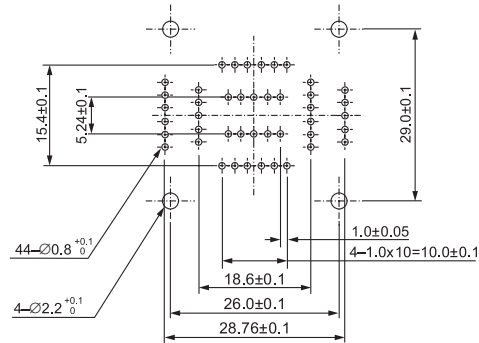

PC BOARD LAYOUTS

QFP, PQFP, TQFP (Clamshell)

IC51 Series

IC51-0484-081 (48 Pins)

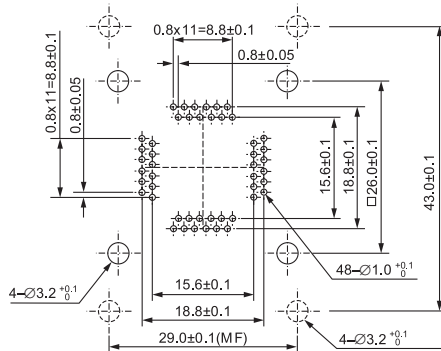

IC51-0564-924 (56 Pins)

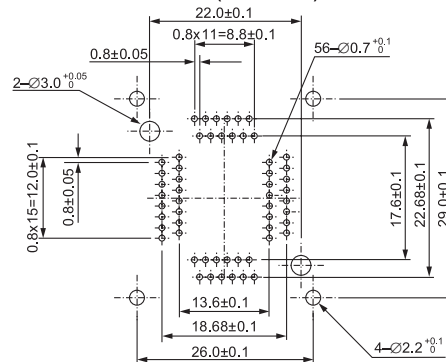

IC51-0564-680 (56 Pins)

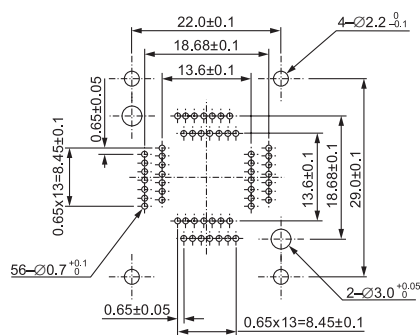

IC51-0564-790 (56 Pins)

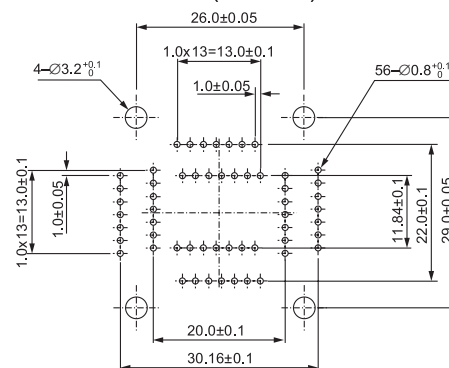

Quad Flat Packages

QFP, PQFP, TQFP (Clamshell)

IC51 Series

PC BOARD LAYOUTS

IC51-1004-809 (100 Pins)

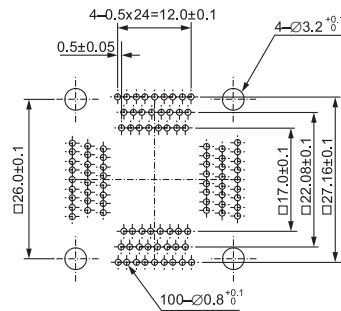

IC51-1004-567 (100 Pins)

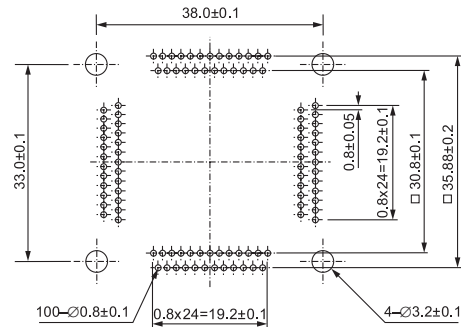

IC51-1124-1036-2 (112 Pins)

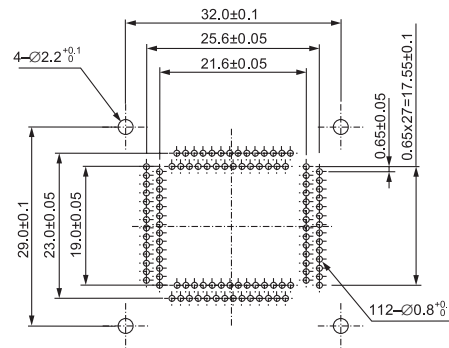

IC51-1004-814-1 (100 Pins)

IC51-1004-814-2 (100 Pins)

IC51-1004-814-13 (100 Pins)

IC51-814-KS12033 (100 Pins)

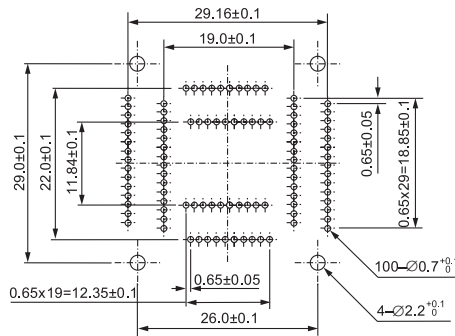

IC51-1204-1812 (120 Pins)

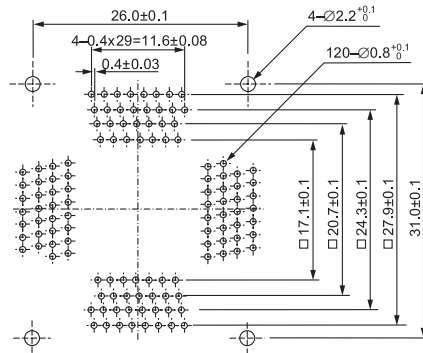

PC BOARD LAYOUTS

QFP, PQFP, TQFP (Clamshell)

IC51 Series

IC51-0644-692 (64 Pins)

IC51-0644-824-1 (64 Pins)

IC51-0644-824-2 (64 Pins)

IC51-0644-824-3 (64 Pins)

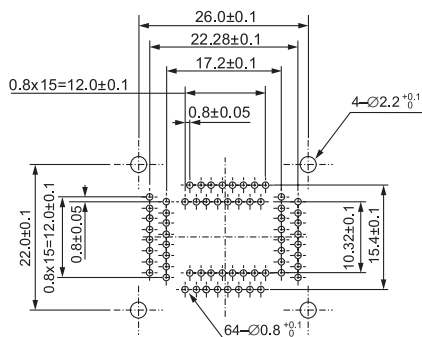

IC51-0684-734 (68 Pins)

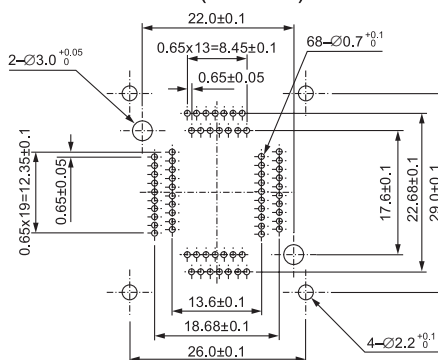

IC51-0644-472 (64 Pins)

IC51-0644-820-1 (64 Pins)

IC51-0644-820-2 (64 Pins)

IC51-0644-820-4 (64 Pins)

IC51-820-2-KS9376 (64 Pins)

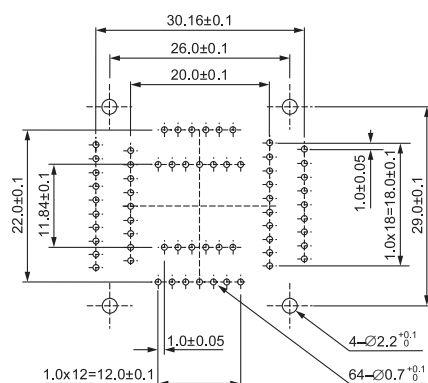

IC51-0724-698 (72 Pins)

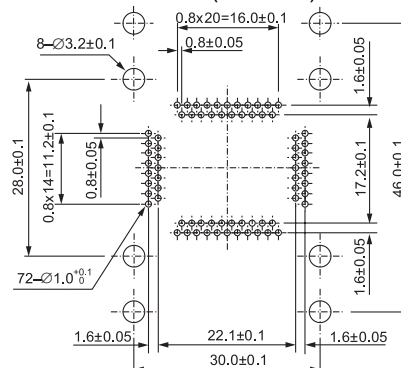

Quad Flat
Packages

IC51 Series

IC51-0804-808 (80 Pins)

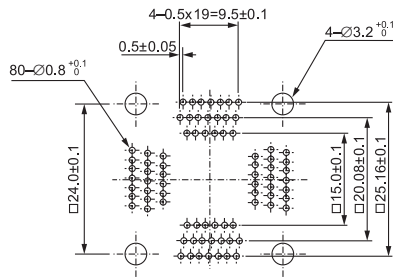

IC51-0804-795 (80 Pins)

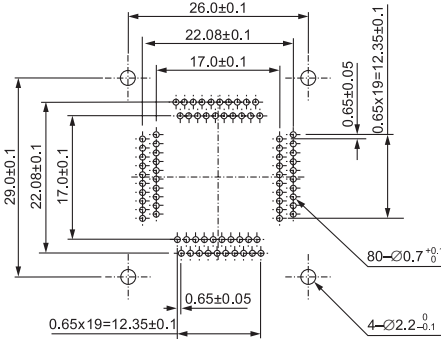

IC51-0804-711 (80 Pins)

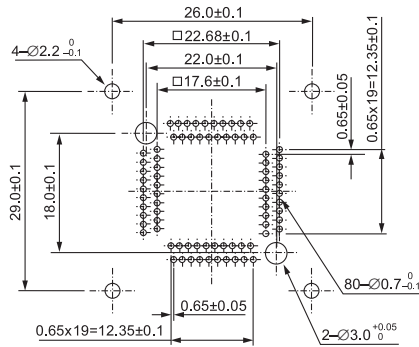

IC51-0804-819-1 (80 Pins)

IC51-0804-819-2 (80 Pins)

IC51-0804-819-8 (80 Pins)

IC51-819-KS12720 (80 Pins)

IC51-0804-956-2 (80 Pins)

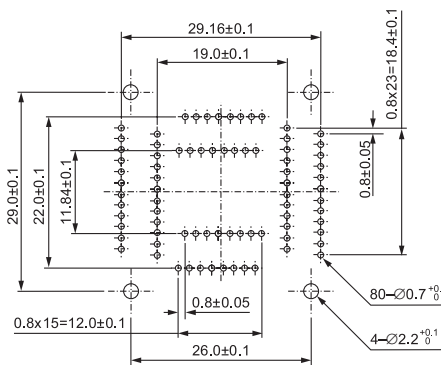
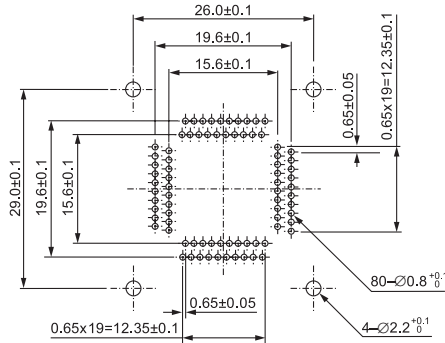

PC BOARD LAYOUTS

QFP, PQFP, TQFP (Clamshell)

IC51 Series

Quad Flat
Packages

IC51 Series

IC51-1204-1652 (120 Pins)

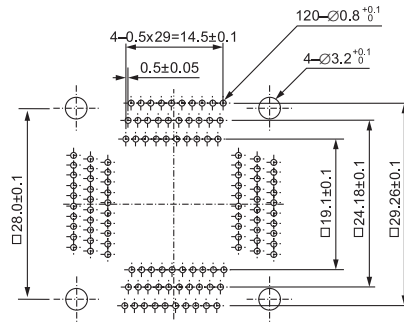

IC51-1284-1433 (128 Pins)
IC51-1284-1433-10 (128 Pins)

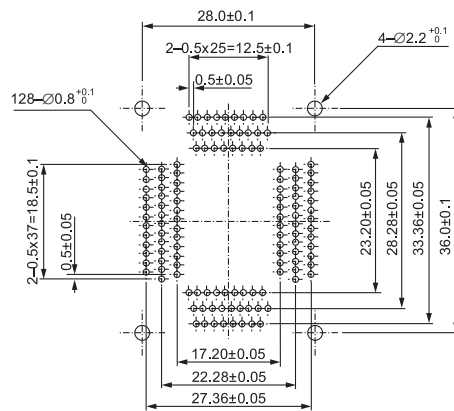

IC51-1497-KS11444 (120 Pins)
IC51-1204-1497 (120 Pins)

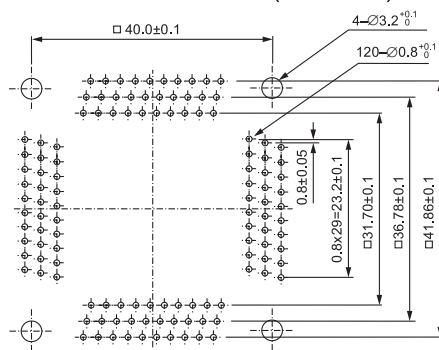

IC51-1284-844-1 (128 Pins)
IC51-1284-976-1 (128 Pins)
IC51-1284-976-2 (128 Pins)
IC51-844-KS13329 (128 Pins)

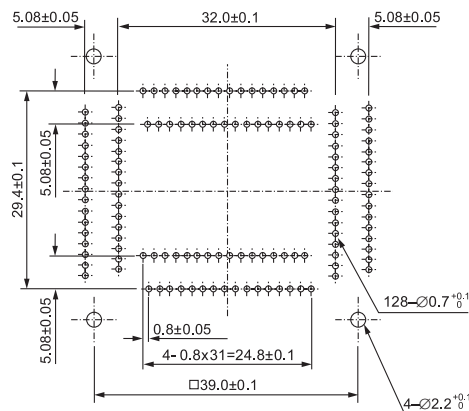

PC BOARD LAYOUTS

QFP, PQFP, TQFP (Clamshell)

IC51 Series

- IC51-1444-1354** (144 Pins)
- IC51-1444-1354-7** (144 Pins)
- IC51-1354-KS11590** (144 Pins)

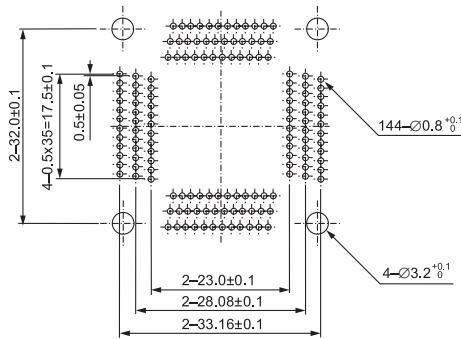

- IC51-1604-1350** (160 Pins)

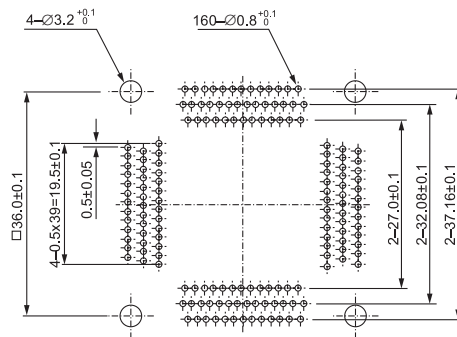

- IC51-1444-1014** (144 Pins)
- IC51-1444-1014-3** (144 Pins)
- IC51-1014-KS11137** (144 Pins)

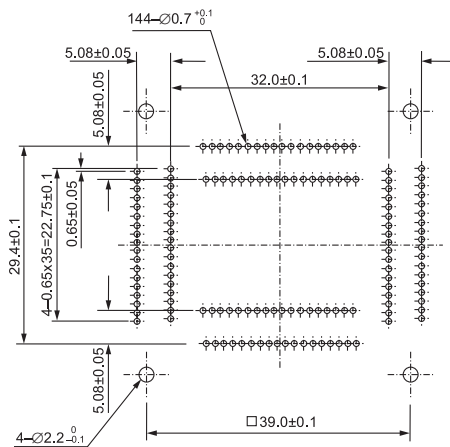

- IC51-1604-845-1** (160 Pins)
- IC51-1604-845-4** (160 Pins)

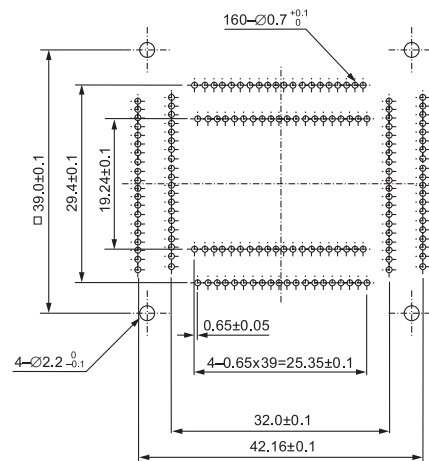

Quad Flat Packages

IC51 Series

PC BOARD LAYOUTS

IC51-1764-1505 (176 Pins)

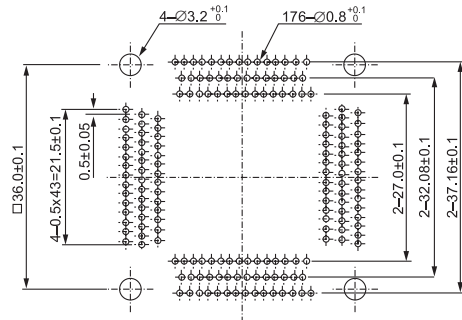

IC51-2084-1052-*¹⁾ (208 Pins)
IC51-2084-1509 (208 Pins)

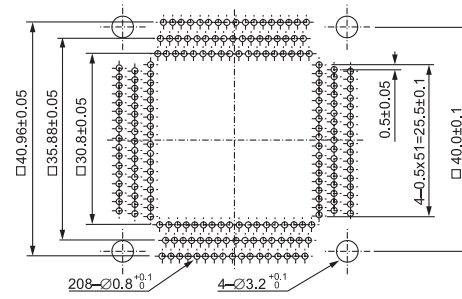

*¹⁾ for type: -1, -2, -3, -5, -6, -7, -9 and -11

IC51-1844-1148-1 (184 Pins)

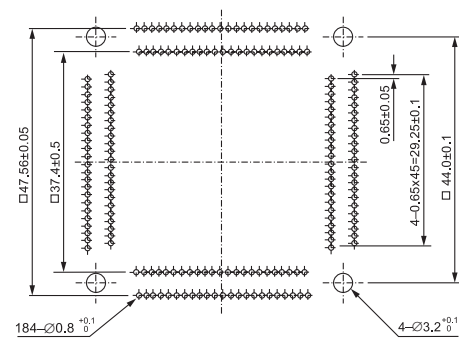

IC51-2084-1052-*²⁾ (208 Pins)

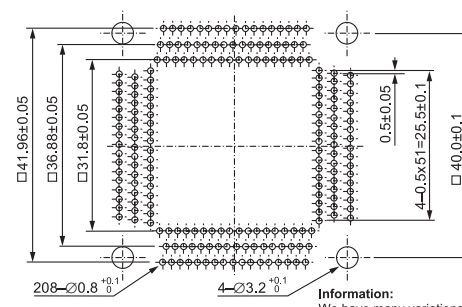

*²⁾ for type: -4, -8 and -13

Information:
We have many variations of this product. Please contact our sales staff for further details.

IC51-1844-1541 (184 Pins)

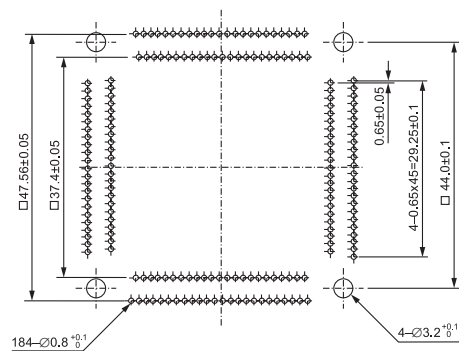

IC51-2404-1655-2 (240 Pins)
IC51-2404-1655-3 (240 Pins)

