

ICS08, ICB12, ICB18 and ICB30 4-wire DC



Proximity inductive sensors with complementary output function



Description

A complete family of high performance inductive sensors and represents Carlo Gavazzi standard solution for industrial automation equipments. It is available in 4 diameters: M8, M12, M18 and M30, in standard and extended sensing ranges, long and short rugged housings.

Benefits

- **A complete family.** Available in M8, M12, M18 and M30 housings with an operating distance from 2 to 22 mm.
- **Less machine downtime.** Lower risk of mechanical damage thanks to the extended range sensors with 2 times the standard operating distance.
- **Easy to install.** ICB sensors have a milled section for wrench grip and two different thread lengths. The user can choose between 2 m PVC cable and M12-disconnect plug versions.
- **High precision.** The onboard advanced microcontroller ensures better stability with respect to environmental influences, with highly repeatable measurements between -25 and +70°C (up to +80°C for ICS).
- **Easy customization to specific OEM requests.** Special sensing distance and timing functions or pig-tail solutions with special cables and connectors are possible on request.
- **Product traceability.** Permanently legible part number and serial number, laser engraved on the plastic cap, guarantee the traceability of every sensor.

Main functions

- Non contact detection of metal objects in general position-sensing and presence-sensing in industrial applications
- Particularly suitable for rotational speed monitoring thanks to the high operating frequency
- Simultaneous availability of both make and break switching functions with maximum connection flexibility to the control unit
- Integrated diagnostic function with flashing LED in the event of a short circuit or overload

References

Order code

 IC A

Enter the code, replacing the symbol with the selected option (e.g.: ICB12S30F04NAM1).

Code	Option	Description
I	-	Inductive sensor
C	-	Cylindrical housing
<input type="checkbox"/>	B	Nickel-plated brass housing
	S	Stainless steel housing
<input type="checkbox"/>	08	M8 housing
	12	M12 housing
	18	M18 housing
	30	M30 housing
<input type="checkbox"/>	S30	Short housing with thread length of 30 mm
	L45	Long housing with thread length of 45 mm
	L50	Long housing with thread length of 50 mm
<input type="checkbox"/>	F	Flush
	N	Non-flush
<input type="checkbox"/>	02	Sensing distance: 2mm
	04	Sensing distance: 4mm
	05	Sensing distance: 5mm
	08	Sensing distance: 8mm
	10	Sensing distance: 10mm
	14	Sensing distance: 14mm
	15	Sensing distance: 15mm
	22	Sensing distance: 22mm
<input type="checkbox"/>	N	NPN
	P	PNP
A	-	Output: N.O. and N.C.
<input type="checkbox"/>	-	2 m cable
	M5	M8 plug
	M1	M12 plug

Additional characters can be used for customized versions.

Type selection

M8 Extended range

Connection	Body style	Detection principle	Output type	Ordering no. Extended range
Cable	Short	Flush	NPN	ICS08S30F02NA
			PNP	ICS08S30F02PA
		Non-flush	NPN	ICS08S30N04NA
			PNP	ICS08S30N04PA
Plug	Short	Flush	NPN	ICS08S30F02NAM5
			PNP	ICS08S30F02PAM5
		Non-flush	NPN	ICS08S30N04NAM5
			PNP	ICS08S30N04PAM5
Cable	Long	Flush	NPN	ICS08L45F02NA
			PNP	ICS08L45F02PA
		Non-flush	NPN	ICS08L45N04NA
			PNP	ICS08L45N04PA
Plug	Long	Flush	NPN	ICS08L45F02NAM5
			PNP	ICS08L45F02PAM5
		Non-flush	NPN	ICS08L45N04NAM5
			PNP	ICS08L45N04PAM5

M12 Standard and extended range

Connection	Body style	Detection principle	Output type	Ordering no. Standard range	Ordering no. Extended range
Cable	Short	Flush	NPN	ICB12S30F02NA	ICB12S30F04NA
			PNP	ICB12S30F02PA	ICB12S30F04PA
		Non-flush	NPN	ICB12S30N04NA	ICB12S30N08NA
			PNP	ICB12S30N04PA	ICB12S30N08PA
Plug	Short	Flush	NPN	ICB12S30F02NAM1	ICB12S30F04NAM1
			PNP	ICB12S30F02PAM1	ICB12S30F04PAM1
		Non-flush	NPN	ICB12S30N04NAM1	ICB12S30N08NAM1
			PNP	ICB12S30N04PAM1	ICB12S30N08PAM1
Cable	Long	Flush	NPN	ICB12L50F02NA	ICB12L50F04NA
			PNP	ICB12L50F02PA	ICB12L50F04PA
		Non-flush	NPN	ICB12L50N04NA	ICB12L50N08NA
			PNP	ICB12L50N04PA	ICB12L50N08PA
Plug	Long	Flush	NPN	ICB12L50F02NAM1	ICB12L50F04NAM1
			PNP	ICB12L50F02PAM1	ICB12L50F04PAM1
		Non-flush	NPN	ICB12L50N04NAM1	ICB12L50N08NAM1
			PNP	ICB12L50N04PAM1	ICB12L50N08PAM1



M18 Standard and extended range

Connection	Body style	Detection principle	Output type	Ordering no. Standard range	Ordering no. Extended range
Cable	Short	Flush	NPN	ICB18S30F05NA	ICB18S30F08NA
			PNP	ICB18S30F05PA	ICB18S30F08PA
		Non-flush	NPN	ICB18S30N08NA	ICB18S30N14NA
			PNP	ICB18S30N08PA	ICB18S30N14PA
Plug	Short	Flush	NPN	ICB18S30F05NAM1	ICB18S30F08NAM1
			PNP	ICB18S30F05PAM1	ICB18S30F08PAM1
		Non-flush	NPN	ICB18S30N08NAM1	ICB18S30N14NAM1
			PNP	ICB18S30N08PAM1	ICB18S30N14PAM1
Cable	Long	Flush	NPN	ICB18L50F05NA	ICB18L50F08NA
			PNP	ICB18L50F05PA	ICB18L50F08PA
		Non-flush	NPN	ICB18L50N08NA	ICB18L50N14NA
			PNP	ICB18L50N08PA	ICB18L50N14PA
Plug	Long	Flush	NPN	ICB18L50F05NAM1	ICB18L50F08NAM1
			PNP	ICB18L50F05PAM1	ICB18L50F08PAM1
		Non-flush	NPN	ICB18L50N08NAM1	ICB18L50N14NAM1
			PNP	ICB18L50N08PAM1	ICB18L50N14PAM1

M30 Standard and extended range

Connection	Body style	Detection principle	Output type	Ordering no. Standard range	Ordering no. Extended range
Cable	Short	Flush	NPN	ICB30S30F10NA	ICB30S30F15NA
			PNP	ICB30S30F10PA	ICB30S30F15PA
		Non-flush	NPN	ICB30S30N15NA	ICB30S30N22NA
			PNP	ICB30S30N15PA	ICB30S30N22PA
Plug	Short	Flush	NPN	ICB30S30F10NAM1	ICB30S30F15NAM1
			PNP	ICB30S30F10PAM1	ICB30S30F15PAM1
		Non-flush	NPN	ICB30S30N15NAM1	ICB30S30N22NAM1
			PNP	ICB30S30N15PAM1	ICB30S30N22PAM1
Cable	Long	Flush	NPN	ICB30L50F10NA	ICB30L50F15NA
			PNP	ICB30L50F10PA	ICB30L50F15PA
		Non-flush	NPN	ICB30L50N15NA	ICB30L50N22NA
			PNP	ICB30L50N15PA	ICB30L50N22PA
Plug	Long	Flush	NPN	ICB30L50F10NAM1	ICB30L50F15NAM1
			PNP	ICB30L50F10PAM1	ICB30L50F15PAM1
		Non-flush	NPN	ICB30L50N15NAM1	ICB30L50N22NAM1
			PNP	ICB30L50N15PAM1	ICB30L50N22PAM1

Structure

ICS08

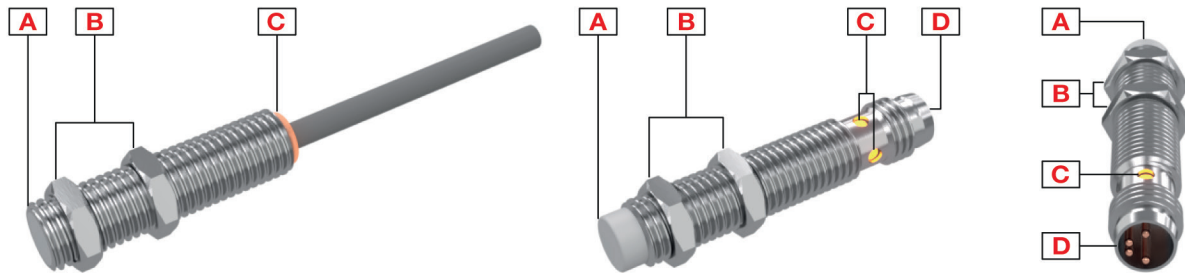

Element	Component	Function
A	Sensing face	Flush or non-flush
B	2 nuts	For sensor mounting
C	LED	Yellow LED: Output flashing: short circuit or overload indication
D	M8, 4 pin, male connector	For plug versions only

ICB12

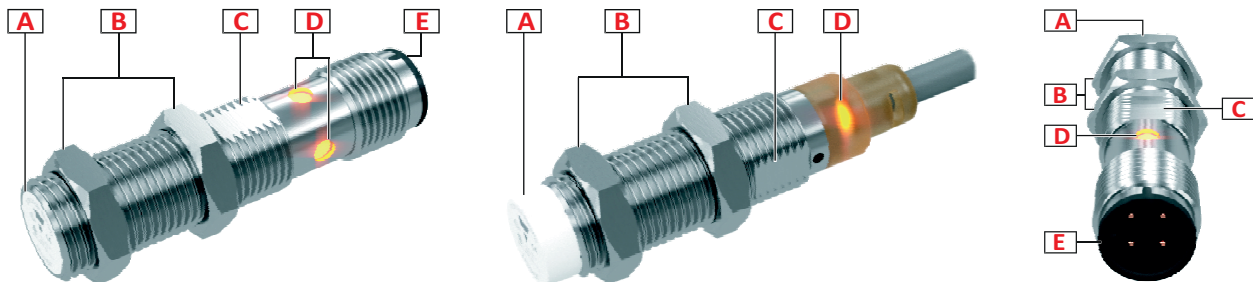

Element	Component	Function
A	Sensing face	Flush or non-flush
B	2 nuts	For sensor mounting
C	Milled section	For wrench grip
D	LED	Yellow LED: Output flashing: short circuit or overload indication
E	M12 x 1, 4 pin, male connector	For plug versions only

ICB18

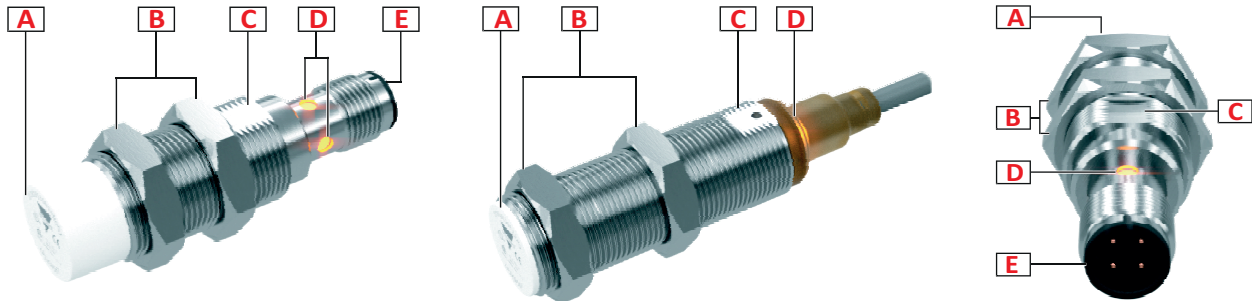

Element	Component	Function
A	Sensing face	Flush or non-flush
B	2 nuts	For sensor mounting
C	Milled section	For wrench grip
D	LED	Yellow LED: Output flashing: short circuit or overload indication
E	M12 x 1, 4 pin, male connector	For plug versions only

ICB30

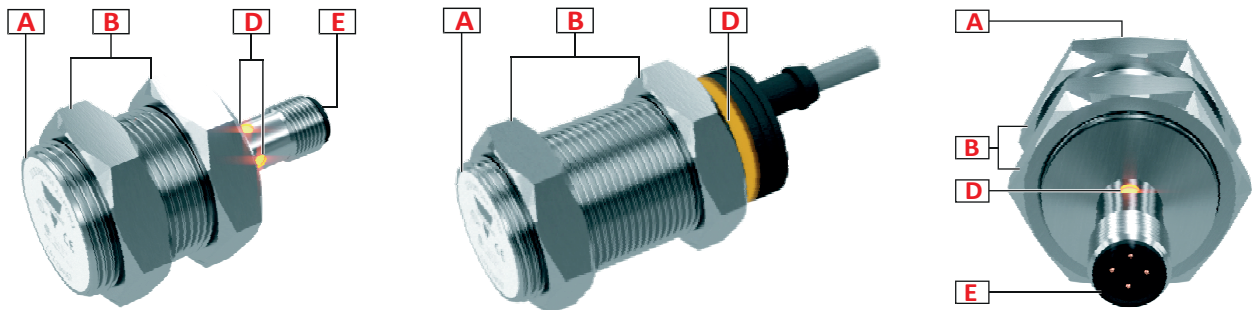

Element	Component	Function
A	Sensing face	Flush or non-flush
B	2 nuts	For sensor mounting
D	LED	Yellow LED: Output flashing: short circuit or overload indication
E	M12 x 1, 4 pin, male connector	For plug versions only

Sensing

Detection

Rated operating distance S_n	2 to 22 mm: depending on housing diameter and version (flush or non-flush; standard or extended range)
Reference target	The operating distance is measured according to IEC 60947-5-2, using a standard target moving axially. This target is square shape 1 mm thickness, made of steel e.g. type Fe 360 as defined in ISO 630 and it shall be of the rolled finish. The length of the side of the square is equal to – the diameter of the circle inscribed on the active surface of the sensing face, or – three times the rated operating distance S_n whichever is greater
Assured operating sensing distance (S_a)	$0 \leq S_a \leq 0.81 \times S_n$ (e.g. with S_n of 15 mm, S_a is 0 ... 12.15 mm)
Effective operating distance (S_r)	$0.9 \times S_n \leq S_r \leq 1.1 \times S_n$
Usable operating distance (S_u)	$0.9 \times S_r \leq S_u \leq 1.1 \times S_r$
Hysteresis (H)	1...20%

Correction factors

The specific operating distance S_n refers to defined measuring conditions. The following data have to be considered as general guidelines.

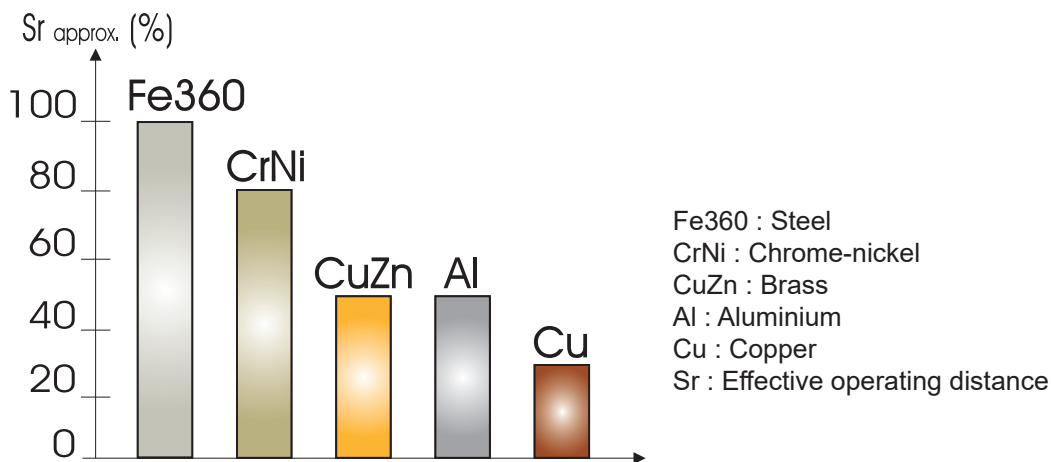

Fig. 1 The rated operating distance is reduced by the use of metals and alloys other than Fe360. The most important reduction factors for inductive proximity sensors are shown in the figure.

Accuracy

Repeat accuracy (R)	ICB: $\leq 10\%$ ICS: $< 5\%$ (S_n)
----------------------------	--

Features

Power Supply

Rated operational voltage (U_b)	10 to 36 VDC (ripple included)
Ripple (U_{rpp})	$\leq 10\%$
No load supply current (I_o)	ICB: ≤ 16 mA ICS: ≤ 15 mA
Power ON delay (t_o)	ICB: ≤ 50 ms ICS: ≤ 20 ms

Outputs

Output functions	NPN or PNP by sensor type	Open collector
Output configuration	N.O. and N.C.	Complementary
Output current (I_o)	≤ 200 mA @ 50°C ; ≤ 150 mA @ $50\dots70^\circ\text{C}$	
OFF-state current (I_o)	≤ 50 μA	
Voltage drop (U_d)	ICB: Max. 2.5 VDC @ 200 mA ICS: Max. 1.6 VDC @ 200 mA	
Protection	Short-circuit, reverse polarity and transients	
Voltage transient	1 kV/0.5 J	

Response times

Operating frequency (f)	≤ 2000 Hz	ICS08, ICB12
	≤ 1500 Hz	ICB18
	≤ 1000 Hz	ICB30

Indication

Yellow LED	Output	Description
OFF	OFF	N.O. output, target not present N.C. output, target present
ON	ON	N.O. output, target present N.C. output, target not present
Blinking (f = 2 Hz)		Short-circuit or overload

Environmental

Ambient temperature ICS	Operating: -25° to +80°C, (-13° to +176°F)	
	Storage: -30° to +80°C (-22° to +176°F)	
Ambient temperature ICB	Operating: -25° to +70°C (-13° to +158°F)	
	Storage: -30° to +80°C (-22° to +176°F)	
Ambient temperature ICB30 plug version only	Operating: -40° to +70°C (-40° to +158°F)	
	Storage: -40° to +80°C (-40° to +176°F)	
Vibration	10 to 55 Hz, amplitude 1.0 mm; sweep cycle 5 min; in X, Y and Z direction	IEC 60068-2-6
Shock	30 G /11 ms. 10 shocks in X, Y and Z direction	IEC 60068-2-27
Degree of protection	IP67	IEC 60529; EN 60947-1

Compatibility and conformity

EMC protection	IEC 61000-4-2 Electrostatic discharge	8 kV air discharge 4 kV contact discharge
	IEC 61000-4-3 Radiated radiofrequency	3 V/m
	IEC 61000-4-4 Burst immunity	2 kV
	IEC 61000-4-6 Conducted radio frequency	3 V
	IEC 61000-4-8 Power frequency magnetic fields	30 A/m
MTTF_d	M8: 2813 years @ 50°C (122°F); M12: 750 years @ 50°C (122°F); M18, M30: 850 years @ 50°C (122°F)	
Approvals		
	CCC is not required for products rated ≤ 36 V	

Mechanical data

Weight (including 2 nuts) max.	Cable version: M8 49 g; M12 120 g; M18 150 g; M30 185 g Plug version: M8 19 g; M12 30 g; M18 70 g, M30 195 g
Mounting	Flush or non flush mountable
Material	ICB: Housing: Nickel-plated brass ICS: Housing: stainless steel AISI304 Front cap: Grey thermoplastic polyester
Max tightening torque	ICS08: 7 Nm ICB12: 10 Nm ICB18 Non-flush version: 25 Nm; Flush version: from 0 to 7 mm: 20 Nm; > 7 mm: 25 Nm ICB30: 25 Nm



Electrical connection

Cable	ICS: 2m grey PVC, oil proof, laser write, 4x0.14mm ²
	ICB12 & ICB18: 2m, 4 x 0.25 mm ² , Ø4.4 mm, PVC, grey, oil proof
	ICB30: 2m, 4 x 0.34 mm ² , Ø5.2 mm, PVC, grey, oil proof
Plug	ICS: M8 x 1, 4 pin, male connector
	ICB: M12 x 1, 4 pin, male connector

Connection Diagrams

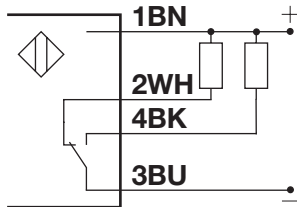

Fig. 2 NPN

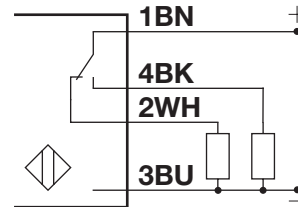

Fig. 3 PNP

Colour code							
BN	Brown	WH	White	BK	Black	BU	Blue

Wire colors in accordance with EN 60947-5-2

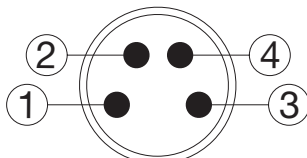

Fig. 4 ICS

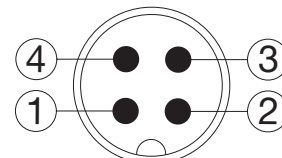

Fig. 5 ICB

Dimensions

ICS08 [mm]

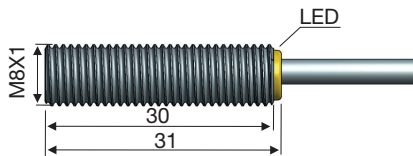

Fig. 6 Short body, flush version, cable

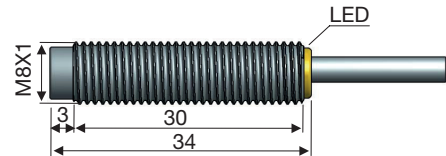

Fig. 7 Short body, non-flush version, cable

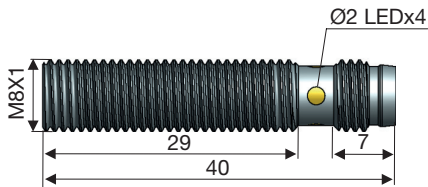

Fig. 8 Short body, flush version, plug

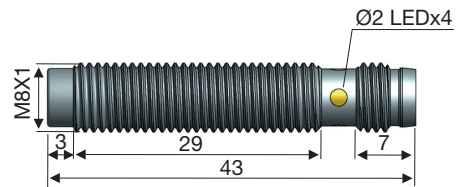

Fig. 9 Short body, non-flush version, plug

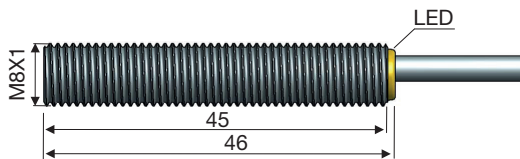

Fig. 10 Long body, flush version, cable

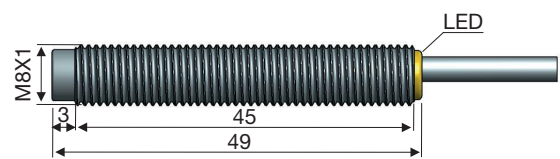

Fig. 11 Long body, non-flush version, cable

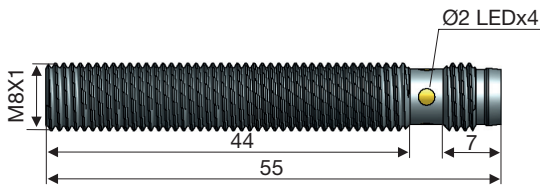

Fig. 12 Long body, flush version, plug

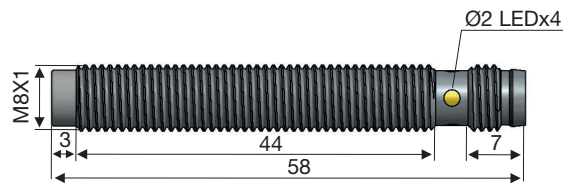

Fig. 13 Long body, non-flush version, plug

ICB12 [mm]

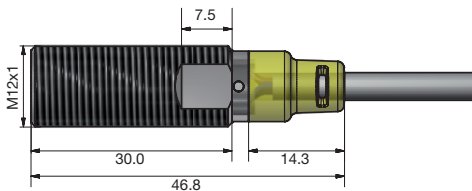

Fig. 14 Short body, flush version, cable

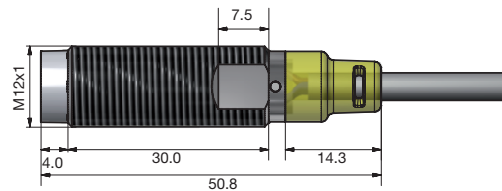

Fig. 15 Short body, non-flush version, cable

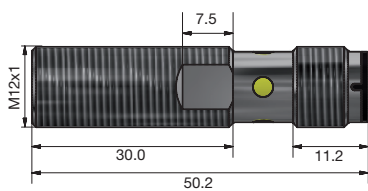

Fig. 16 Short body, flush version, plug

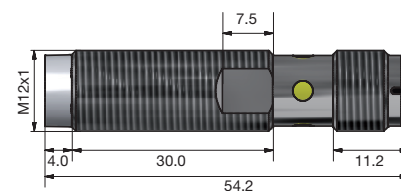

Fig. 17 Short body, non-flush version, plug

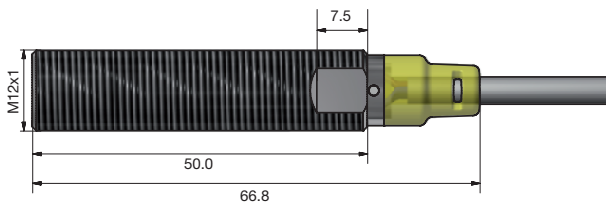

Fig. 18 Long body, flush version, cable

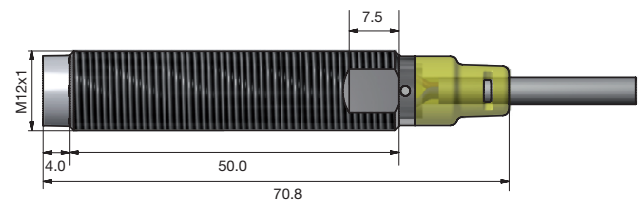

Fig. 19 Long body, non-flush version, cable

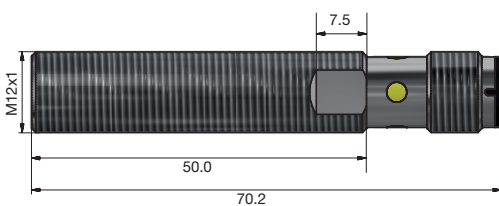

Fig. 20 Long body, flush version, plug

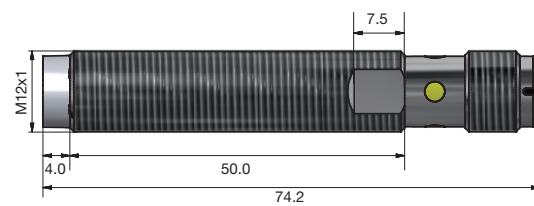

Fig. 21 Long body, non-flush version, plug

ICB18 [mm]

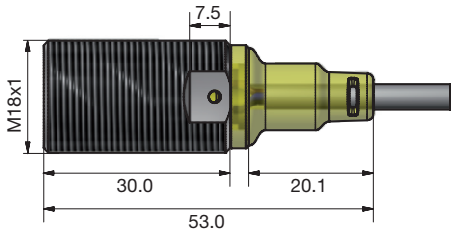

Fig. 22 Short body, flush version, cable

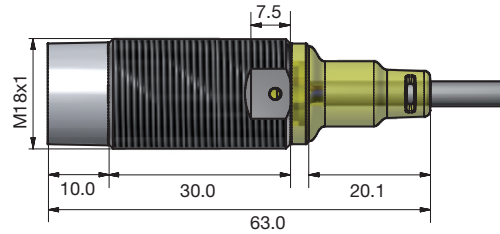

Fig. 23 Short body, non-flush version, cable

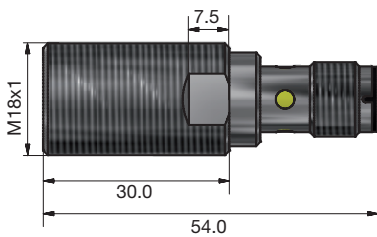

Fig. 24 Short body, flush version, plug

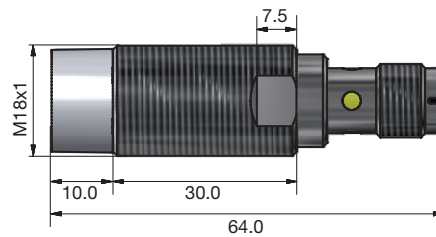

Fig. 25 Short body, non-flush version, plug

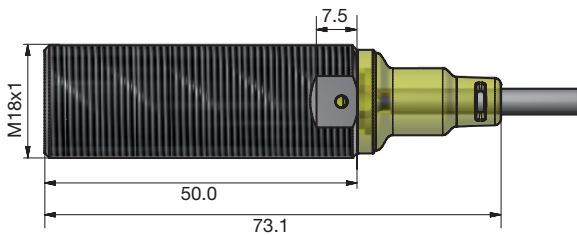

Fig. 26 Long body, flush version, cable

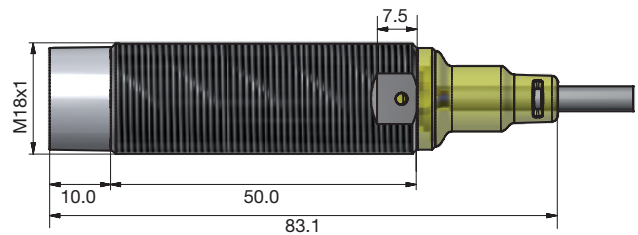

Fig. 27 Long body, non-flush version, cable

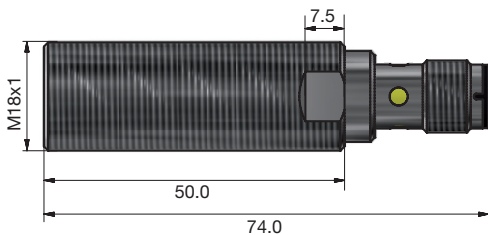

Fig. 28 Long body, flush version, plug

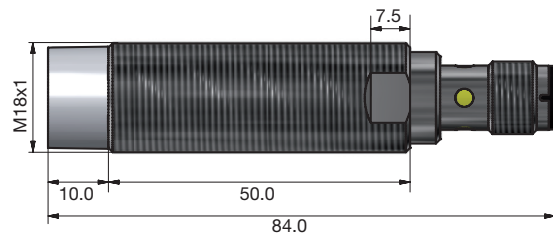

Fig. 29 Long body, non-flush version, plug

ICB30 [mm]

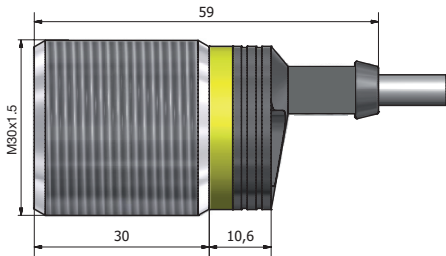

Fig. 30 Short body, flush version, cable

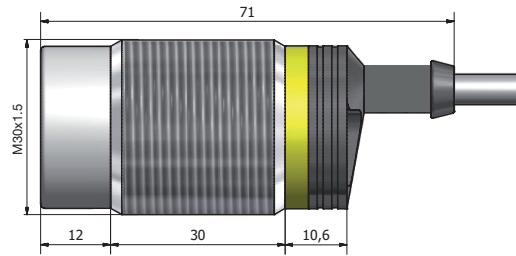

Fig. 31 Short body, non-flush version, cable

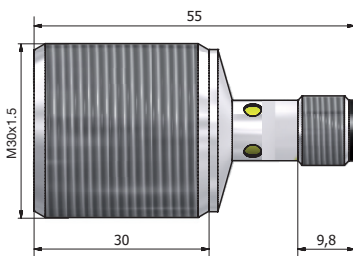

Fig. 32 Short body, flush version, plug

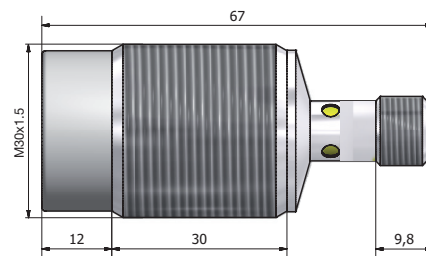

Fig. 33 Short body, non-flush version, plug

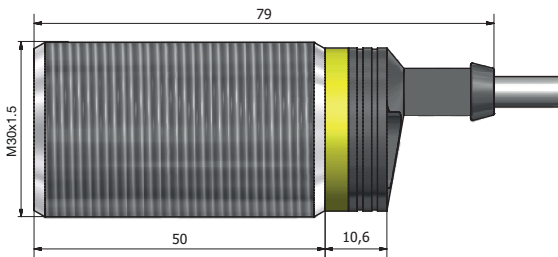

Fig. 34 Long body, flush version, cable

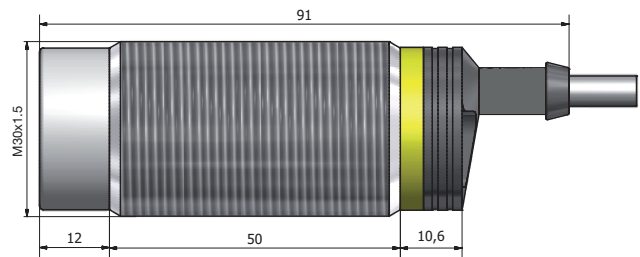

Fig. 35 Long body, non-flush version, cable

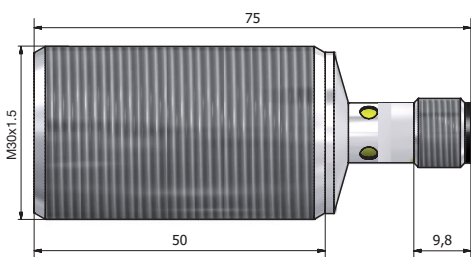

Fig. 36 Long body, flush version, plug

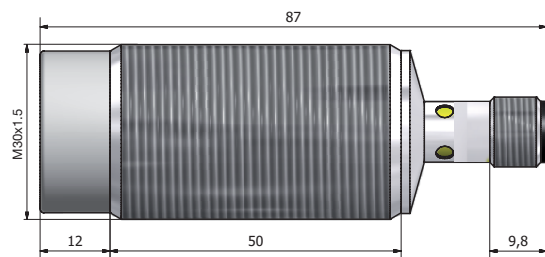

Fig. 37 Long body, non-flush version, plug

Installation

M8, M12, M18 and M30 flush

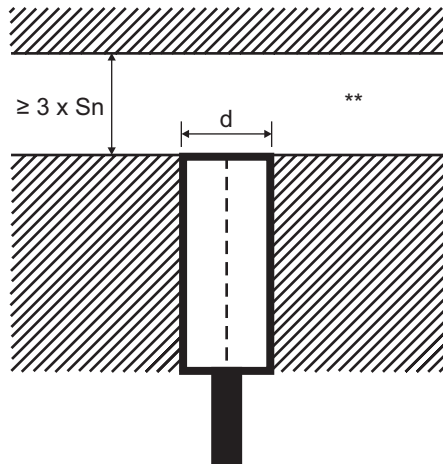

Fig. 38 Flush sensor, when installed in damping material

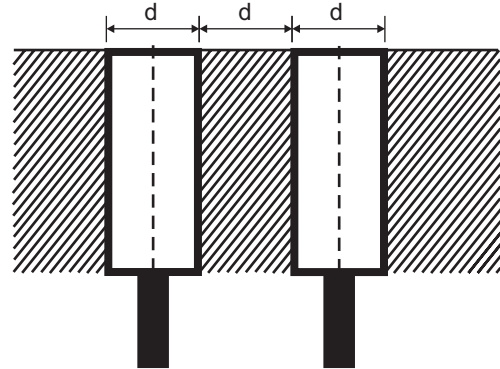

Fig. 39 Flush sensors, when installed together in damping material

M8, M12 and M18 non-flush

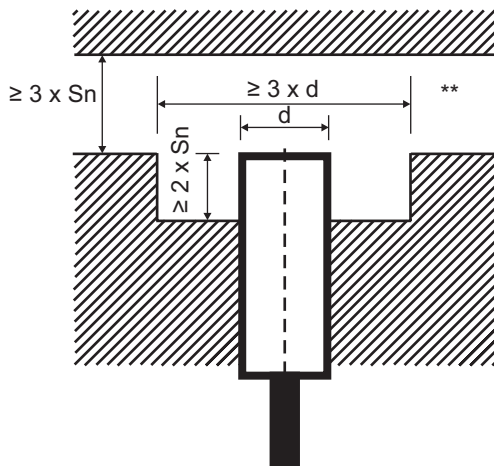

Fig. 40 Non-flush sensor, when installed in damping material

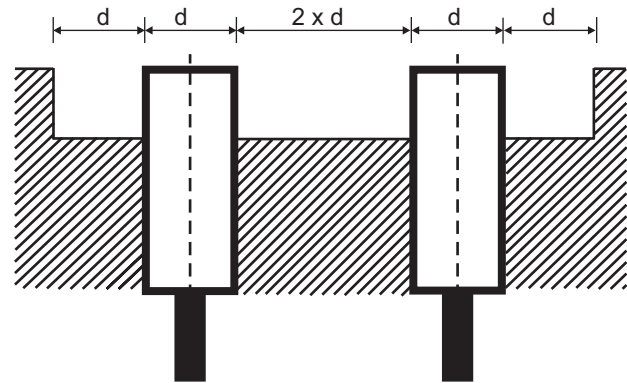

Fig. 41 Non-flush sensors, when installed together in damping material

M30 non-flush

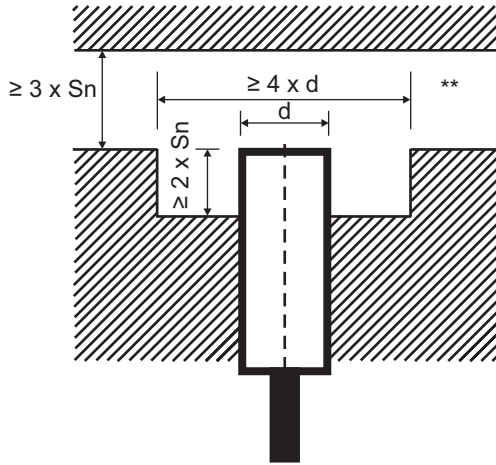

Fig. 42 Non-flush sensor, when installed in damping material

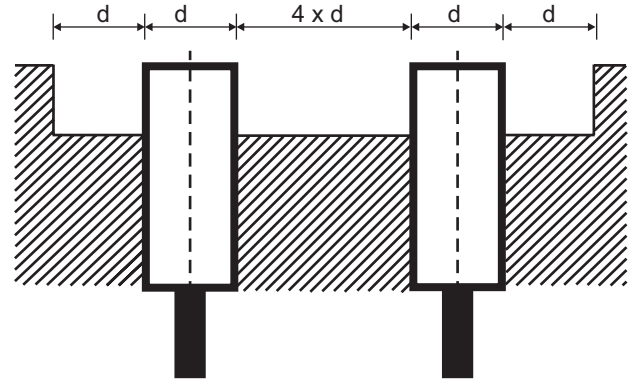

Fig. 43 Non-flush sensor, when installed together in damping material

Sensors installed opposite each other

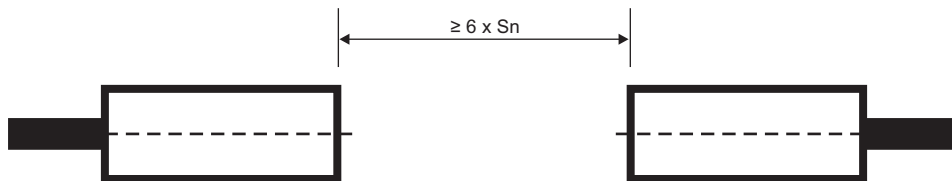

Fig. 44 For sensors installed opposite each other, a minimum space of $6 \times S_n$ (the nominal sensing distance) must be observed

** Free zone or non-damping material

S_n : nominal sensing distance

d : sensor diameter (8 mm for ICS08, 12 mm for ICB12, 18 mm for ICB18, 30 mm for ICB30)