

# Proximity Inductive Sensors Extended Range, Nickel-Plated Brass Housing Types ICB, M18

CARLO GAVAZZI



- Sensing distance: 8 to 14 mm
- Flush or non-flush types
- Short or long body versions
- Rated operational voltage ( $U_b$ ): 10 - 36 VDC
- Output: DC 200 mA, NPN or PNP
- Normally open or Normally closed
- LED indication for output ON
- Protection: reverse polarity, short circuit, transients
- Cable or M12 plug versions
- According to IEC 60947-5-2
- Laser engraved on front cap, permanently legible
- CSA certified for Hazardous Locations



## Product Description

A family of inductive proximity switches in industrial standard nickel-plated brass housings. They are able to handle applications where high sensing range is requested.

Output is open collector NPN or PNP transistors.

## Ordering Key **ICB18S30F08NOM1**

Type	_____
Housing style	_____
Housing material	_____
Housing size	_____
Housing length	_____
Thread length	_____
Detection principle	_____
Sensing distance	_____
Output type	_____
Output configuration	_____
Connection	_____

## Type Selection

Connection	Body style	Rated operating distance $S_n$	Ordering no. NPN, Normally open	Ordering no. PNP, Normally open	Ordering no. NPN, Normally closed	Ordering no. PNP, Normally closed
Cable	Short	8 mm <sup>1)</sup>	ICB18S30F08NO	ICB18S30F08PO	ICB18S30F08NC	ICB18S30F08PC
Cable	Short	14 mm <sup>2)</sup>	ICB18S30N14NO	ICB18S30N14PO	ICB18S30N14NC	ICB18S30N14PC
Plug	Short	8 mm <sup>1)</sup>	ICB18S30F08NOM1	ICB18S30F08POM1	ICB18S30F08NCM1	ICB18S30F08PCM1
Plug	Short	14 mm <sup>2)</sup>	ICB18S30N14NOM1	ICB18S30N14POM1	ICB18S30N14NCM1	ICB18S30N14PCM1
Cable	Long	8 mm <sup>1)</sup>	ICB18L50F08NO	ICB18L50F08PO	ICB18L50F08NC	ICB18L50F08PC
Cable	Long	14 mm <sup>2)</sup>	ICB18L50N14NO	ICB18L50N14PO	ICB18L50N14NC	ICB18L50N14PC
Plug	Long	8 mm <sup>1)</sup>	ICB18L50F08NOM1	ICB18L50F08POM1	ICB18L50F08NCM1	ICB18L50F08PCM1
Plug	Long	14 mm <sup>2)</sup>	ICB18L50N14NOM1	ICB18L50N14POM1	ICB18L50N14NCM1	ICB18L50N14PCM1

<sup>1)</sup> For flush mounting in metal

<sup>2)</sup> For non-flush mounting in metal

## Specifications

<b>Rated operational voltage (<math>U_b</math>)</b>	10 to 36 VDC (ripple incl.)	<b>Indication for short circuit/ overload</b>	LED blinking (f = 2 Hz)
<b>Ripple</b>	≤ 10%	<b>Assured operating sensing distance (<math>S_a</math>)</b>	$0 \leq S_a \leq 0.81 \times S_n$
<b>Output current (<math>I_o</math>)</b>	≤ 200 mA @ 50°C (≤ 150 mA @ 50-70°C)	<b>Effective operating distance (<math>S_r</math>)</b>	$0.9 \times S_n \leq S_r \leq 1.1 \times S_n$
<b>OFF-state current (<math>I_r</math>)</b>	≤ 50 μA	<b>Usable operating distance (<math>S_u</math>)</b>	$0.9 \times S_r \leq S_u \leq 1.1 \times S_r$
<b>No load supply current (<math>I_o</math>)</b>	≤ 15 mA	<b>Repeat accuracy (R)</b>	≤ 10%
<b>Voltage drop (<math>U_d</math>)</b>	Max. 2.5 VDC @ 200 mA	<b>Differential travel (H) (Hysteresis)</b>	1 to 20% of sensing dist.
<b>Protection</b>	Reverse polarity, short-circuit, transients	<b>Ambient temperature</b>	Operating: -25° to +70°C (-13° to +158°F) Storage: -30° to +80°C (-22° to +176°F)
<b>Voltage transient</b>	1 kV/0.5 J	<b>Shock and vibration</b>	IEC 60947-5-2/7.4
<b>Power ON delay (<math>t_o</math>)</b>	≤ 20 ms	<b>Housing material</b>	Body: Nickel-plated brass Front: Grey thermoplastic polyester
<b>Operating frequency (f)</b>	≤ 1500 Hz		
<b>Indication for output ON</b>	Activated LED, yellow		
NO version	Target present		
NC version	Target not present		

## Specifications (cont.)

<b>Connection</b>	
Cable	Ø4.1 x 2 m, 3 x 0.25 mm <sup>2</sup> , grey PVC, oil proof
Plug	M12 x 1
<b>Degree of protection</b>	IP 67
<b>Weight</b> (cable/nuts included)	
Cable	Max. 150 g
Plug	Max. 70 g
<b>Dimensions</b>	See diagrams below
<b>Tightening torque</b>	
Non-flush version	25 Nm
Flush version	
From 0 to 7 mm	20 Nm
> 7 mm	25 Nm
<b>Approvals</b>	<p><b>cULus</b> (UL508)</p> <p><b>cCSAus</b> As Process Control Equipment for Hazardous Locations.</p> <ul style="list-style-type: none"> <li>- Class I, Division 2, Groups A, B, C and D.</li> <li>- T5 up to 150mA, T4A for a load current &gt; 150mA and up to 200 mA, Enclosure Type 4.</li> </ul>

Note: The terminal connector (version ...M1) was not evaluated. The suitability of the terminal connector should be determined in the end-use application.

<b>Approvals (cont.)</b>	<p>Ambient temperature</p> <p>Ta: -25° to +60°C</p> <p>CCC is not required for products with a maximum operating voltage of ≤ 36 V</p>
<b>EMC protection</b>	<p>IEC 61000-4-2 (ESD)</p> <p>IEC 61000-4-3</p> <p>IEC 61000-4-4</p> <p>IEC 61000-4-6</p> <p>IEC 61000-4-8</p>
<b>MTTF<sub>d</sub></b>	850 years @ 50°C (122°F)
	<p>According to IEC 60947-5-2</p> <p>8 KV air discharge,</p> <p>4 KV contact discharge</p> <p>3 V/m</p> <p>2 kV</p> <p>3 V</p> <p>30 A/m</p>

## Dimensions (mm)

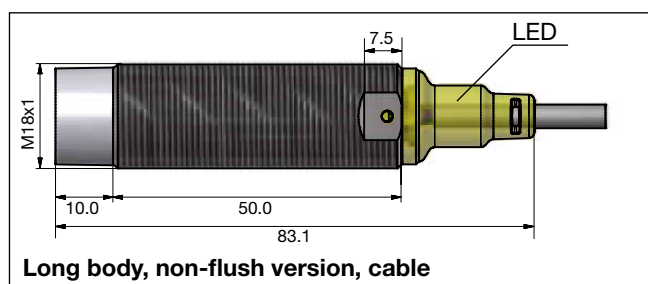
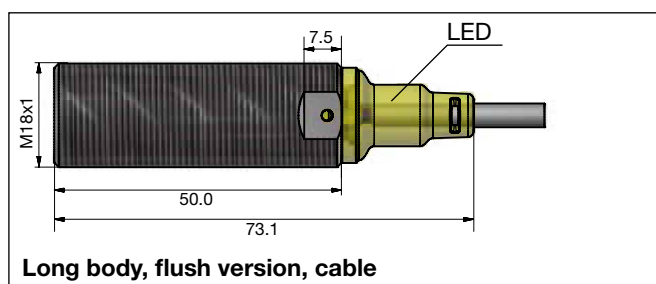
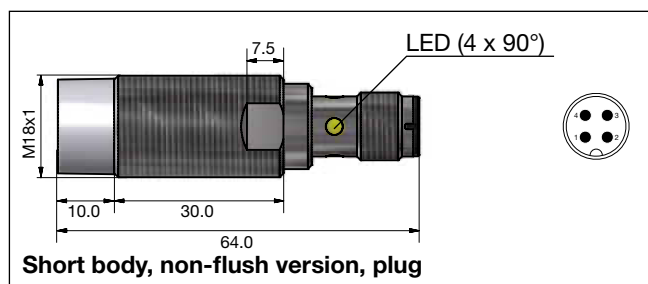
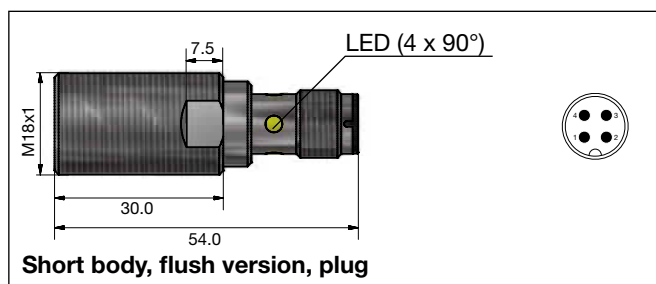
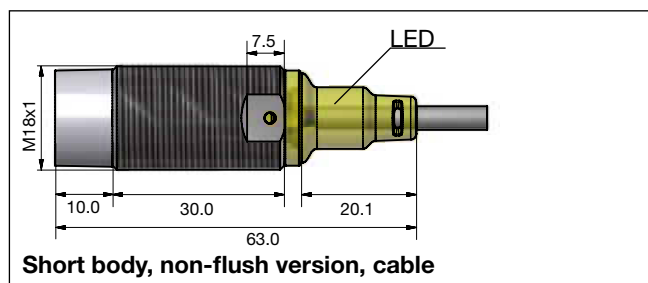
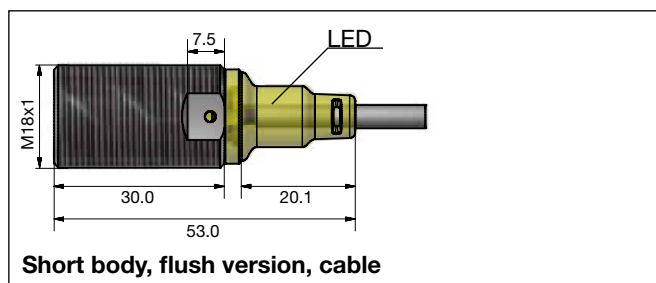

## Dimensions (mm) (cont.)



## Installation

Flush sensor, when installed in damping material, must be according to Picture 1A.



Non-flush sensor, when installed in damping material, must be according to Picture 1B.



Flush sensors, when installed together in damping material, must be according to Picture 2A.

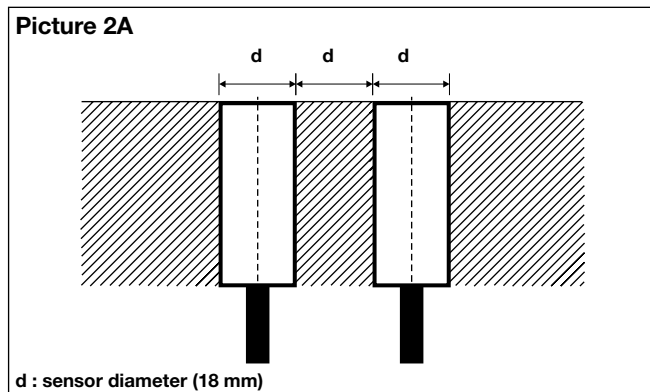

Non-flush sensors, when installed together in damping material, must be according to Picture 2B.



For sensors installed opposite each other, a minimum space of  $6 \times S_n$  (the nominal sensing distance) must be observed (See Picture 3).

