

Proximity Inductive Sensors Extended Range, Nickel-Plated Brass Housing Types ICB, M18

CARLO GAVAZZI



- Sensing distance: 8 to 14 mm
- Flush or non-flush types
- Short or long body versions
- Rated operational voltage (U_b): 10 - 36 VDC
- Output: DC 200 mA, NPN or PNP
- Normally open or Normally closed
- LED indication for output ON
- Protection: reverse polarity, short circuit, transients
- Cable or M12 plug versions
- According to IEC 60947-5-2
- Laser engraved on front cap, permanently legible
- CSA certified for Hazardous Locations



Product Description

A family of inductive proximity switches in industrial standard nickel-plated brass housings. They are able to handle applications where high sensing range is requested.

Output is open collector NPN or PNP transistors.

Ordering Key **ICB18S30F08NOM1**

Type	_____
Housing style	_____
Housing material	_____
Housing size	_____
Housing length	_____
Thread length	_____
Detection principle	_____
Sensing distance	_____
Output type	_____
Output configuration	_____
Connection	_____

Type Selection

Connection	Body style	Rated operating distance S_n	Ordering no. NPN, Normally open	Ordering no. PNP, Normally open	Ordering no. NPN, Normally closed	Ordering no. PNP, Normally closed
Cable	Short	8 mm ¹⁾	ICB18S30F08NO	ICB18S30F08PO	ICB18S30F08NC	ICB18S30F08PC
Cable	Short	14 mm ²⁾	ICB18S30N14NO	ICB18S30N14PO	ICB18S30N14NC	ICB18S30N14PC
Plug	Short	8 mm ¹⁾	ICB18S30F08NOM1	ICB18S30F08POM1	ICB18S30F08NCM1	ICB18S30F08PCM1
Plug	Short	14 mm ²⁾	ICB18S30N14NOM1	ICB18S30N14POM1	ICB18S30N14NCM1	ICB18S30N14PCM1
Cable	Long	8 mm ¹⁾	ICB18L50F08NO	ICB18L50F08PO	ICB18L50F08NC	ICB18L50F08PC
Cable	Long	14 mm ²⁾	ICB18L50N14NO	ICB18L50N14PO	ICB18L50N14NC	ICB18L50N14PC
Plug	Long	8 mm ¹⁾	ICB18L50F08NOM1	ICB18L50F08POM1	ICB18L50F08NCM1	ICB18L50F08PCM1
Plug	Long	14 mm ²⁾	ICB18L50N14NOM1	ICB18L50N14POM1	ICB18L50N14NCM1	ICB18L50N14PCM1

¹⁾ For flush mounting in metal

²⁾ For non-flush mounting in metal

Specifications

Rated operational voltage (U_b)	10 to 36 VDC (ripple incl.)	Indication for short circuit/ overload	LED blinking (f = 2 Hz)
Ripple	≤ 10%	Assured operating sensing distance (S_a)	$0 \leq S_a \leq 0.81 \times S_n$
Output current (I_a)	≤ 200 mA @ 50°C (≤ 150 mA @ 50-70°C)	Effective operating distance (S_r)	$0.9 \times S_n \leq S_r \leq 1.1 \times S_n$
OFF-state current (I_r)	≤ 50 μA	Usable operating distance (S_u)	$0.9 \times S_r \leq S_u \leq 1.1 \times S_r$
No load supply current (I_o)	≤ 15 mA	Repeat accuracy (R)	≤ 10%
Voltage drop (U_d)	Max. 2.5 VDC @ 200 mA	Differential travel (H) (Hysteresis)	1 to 20% of sensing dist.
Protection	Reverse polarity, short-circuit, transients	Ambient temperature	Operating: -25° to +70°C (-13° to +158°F) Storage: -30° to +80°C (-22° to +176°F)
Voltage transient	1 kV/0.5 J	Shock and vibration	IEC 60947-5-2/7.4
Power ON delay (t_v)	≤ 20 ms	Housing material	Body: Nickel-plated brass Front: Grey thermoplastic polyester
Operating frequency (f)	≤ 1500 Hz		
Indication for output ON	Activated LED, yellow		
NO version	Target present		
NC version	Target not present		

Specifications (cont.)

Connection	
Cable	Ø4.1 x 2 m, 3 x 0.25 mm ² , grey PVC, oil proof
Plug	M12 x 1
Degree of protection	IP 67
Weight (cable/nuts included)	
Cable	Max. 150 g
Plug	Max. 70 g
Dimensions	See diagrams below
Tightening torque	
Non-flush version	25 Nm
Flush version	
From 0 to 7 mm	20 Nm
> 7 mm	25 Nm
Approvals	cULus (UL508)
	cCSAus As Process Control Equipment for Hazardous Locations.
	- Class I, Division 2, Groups A, B, C and D.
	- T5 up to 150mA, T4A for a load current > 150mA and up to 200 mA, Enclosure Type 4.

Note: The terminal connector (version ...M1) was not evaluated. The suitability of the terminal connector should be determined in the end-use application.

Approvals (cont.)	Ambient temperature Ta: -25° to +60°C CCC is not required for products with a maximum operating voltage of ≤ 36 V
EMC protection IEC 61000-4-2 (ESD)	According to IEC 60947-5-2 8 KV air discharge, 4 KV contact discharge 3 V/m 2 kV 3 V 30 A/m
IEC 61000-4-3	3 V/m
IEC 61000-4-4	2 kV
IEC 61000-4-6	3 V
IEC 61000-4-8	30 A/m
MTTF_d	850 years @ 50°C (122°F)

Dimensions (mm)

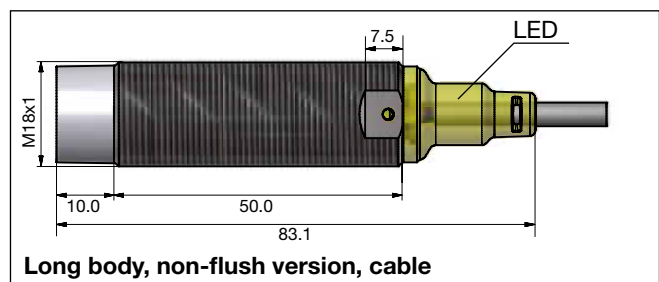
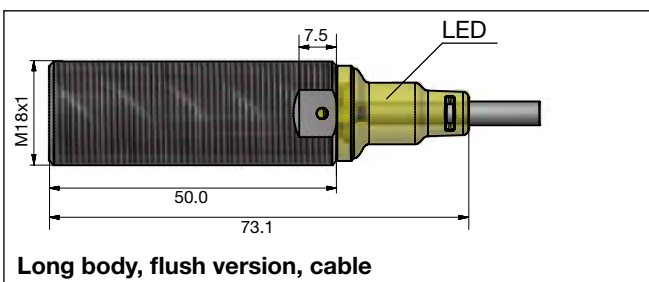
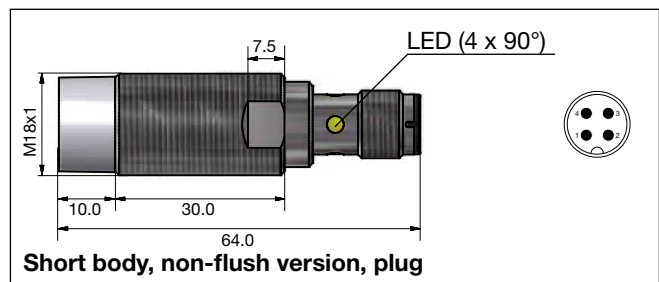
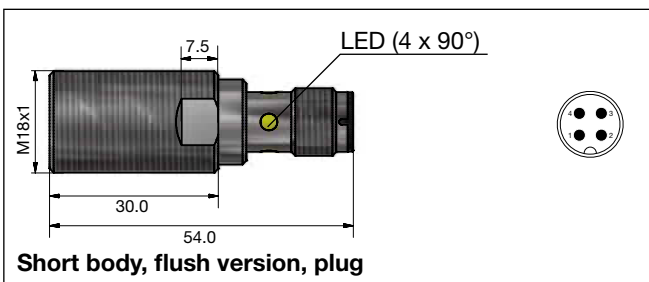
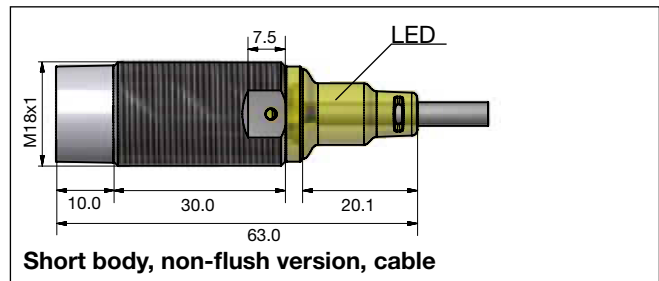
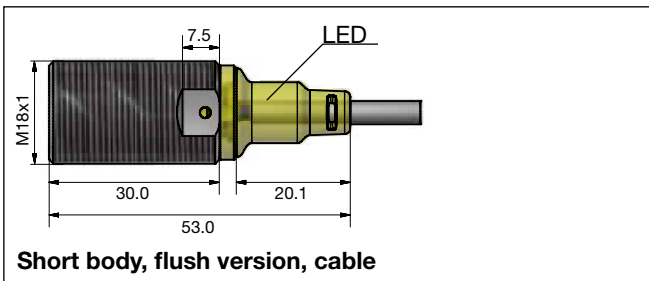

Dimensions (mm) (cont.)



Installation

Flush sensor, when installed in damping material, must be according to Picture 1A.



Non-flush sensor, when installed in damping material, must be according to Picture 1B.



Flush sensors, when installed together in damping material, must be according to Picture 2A.

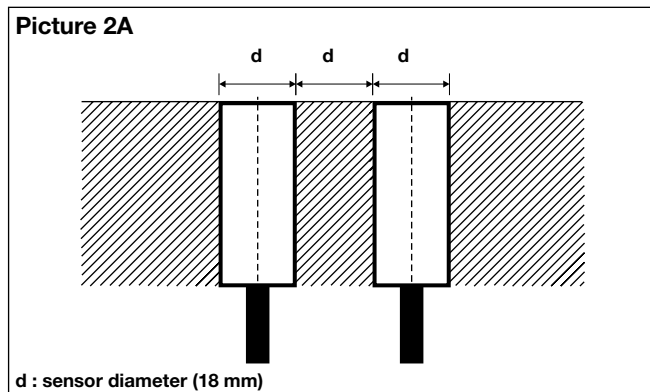

Non-flush sensors, when installed together in damping material, must be according to Picture 2B.



For sensors installed opposite each other, a minimum space of $6 \times S_n$ (the nominal sensing distance) must be observed (See Picture 3).

