

Proximity Inductive Sensors Standard Range, Nickel-Plated Brass Housing Types ICB, M30

CARLO GAVAZZI



- Sensing distance: 10 to 15 mm
- Flush or non-flush types
- Short or long body versions
- Rated operational voltage (U_b): 10 - 36 VDC
- Output: DC 200 mA, NPN or PNP
- Normally open or Normally closed
- LED indication for output ON, short-circuit and overload
- Protection: reverse polarity, short circuit, transients
- Cable or M12 plug versions
- According to IEC 60947-5-2
- Laser engraved on front cap, permanently legible
- CSA certified for Hazardous Locations



Product Description

A family of inductive proximity switches in industrial standard nickel-plated brass housings. They are able to handle applications where high sensing range is requested.

Output is open collector NPN or PNP transistors.

Ordering Key

ICB30S30F10NOM1

Type	_____
Housing style	_____
Housing material	_____
Housing size	_____
Housing length	_____
Thread length	_____
Detection principle	_____
Sensing distance	_____
Output type	_____
Output configuration	_____
Connection	_____

Type Selection

Conne- ction	Body style	Rated operating distance S_n	Ordering no. NPN, Normally open	Ordering no. PNP, Normally open	Ordering no. NPN, Normally closed	Ordering no. PNP, Normally closed
Cable	Short	10 mm ¹⁾	ICB30S30F10NO	ICB30S30F10PO	ICB30S30F10NC	ICB30S30F10PC
Cable	Short	15 mm ²⁾	ICB30S30N15NO	ICB30S30N15PO	ICB30S30N15NC	ICB30S30N15PC
Plug	Short	10 mm ¹⁾	ICB30S30F10NOM1	ICB30S30F10POM1	ICB30S30F10NCM1	ICB30S30F10PCM1
Plug	Short	15 mm ²⁾	ICB30S30N15NOM1	ICB30S30N15POM1	ICB30S30N15NCM1	ICB30S30N15PCM1
Cable	Long	10 mm ¹⁾	ICB30L50F10NO	ICB30L50F10PO	ICB30L50F10NC	ICB30L50F10PC
Cable	Long	15 mm ²⁾	ICB30L50N15NO	ICB30L50N15PO	ICB30L50N15NC	ICB30L50N15PC
Plug	Long	10 mm ¹⁾	ICB30L50F10NOM1	ICB30L50F10POM1	ICB30L50F10NCM1	ICB30L50F10PCM1
Plug	Long	15 mm ²⁾	ICB30L50N15NOM1	ICB30L50N15POM1	ICB30L50N15NCM1	ICB30L50N15PCM1

¹⁾ For flush mounting in metal

²⁾ For non-flush mounting in metal

Specifications

Rated operational voltage (U_b)	10 to 36 VDC (ripple incl.)	Indication for output ON	Activated LED, yellow NO version Target present NC version Target not present
Ripple	≤ 10%	Indication for short circuit/ overload	LED blinking (f = 2 Hz)
Output current (I_o)	≤ 200 mA @ 50°C (≤ 150 mA @ 50-70°C)	Assured operating sensing distance (S_a)	$0 \leq S_a \leq 0.81 \times S_n$
OFF-state current (I_i)	≤ 50 μA	Effective operating distance (S_r)	$0.9 \times S_n \leq S_r \leq 1.1 \times S_n$
No load supply current (I_o)	≤ 15 mA	Usable operating distance (S_u)	$0.85 \times S_r \leq S_u \leq 1.1 \times S_r$
Voltage drop (U_d)	Max. 2.5 VDC @ 200 mA	Repeat accuracy (R)	≤ 5%
Protection	Reverse polarity, short-circuit, transients	Differential travel (H) (Hysteresis)	1 to 20% of sensing dist.
Voltage transient	1 kV/0.5 J		
Power ON delay (t_v)	300 ms		
Operating frequency (f)	≤ 1000 Hz		

Specifications (cont.)

Ambient temperature	
Operating	
Cable	-25° to +70°C (-13° to +158°F)
Plug	-40° to +70°C (-40° to +158°F)
Storage	-40° to +80°C (-40° to +176°F)
Shock and vibration	IEC 60947-5-2/7.4
Housing material	
Body	Nickel-plated brass
Front cap	Grey thermoplastic polyester
Connection	
Cable	Ø5.2 x 2 m, 3 x 0.34 mm ² , grey PVC, oil proof
Plug	M12 x 1
Degree of protection	IP 67
Weight (cable/nuts included)	
ICB30 S	Max. 185 g
ICB30 L	Max. 195 g
Dimensions	See diagrams below
Tightening torque	25 Nm
Approvals	cULus (UL508)

Approvals (cont.)

cCSAus

Note: The terminal connector (version ...M1) was not evaluated. The suitability of the terminal connector should be determined in the end-use application.

As Process Control Equipment for Hazardous Locations.

- Class I, Division 2, Groups A, B, C and D.
- T5 up to 150 mA, T4A for a load current > 150 mA and up to 200 mA, Enclosure Type 4.

Ambient temperature
Ta: -25° to +60°C.

CCC is not required for products with a maximum operating voltage of ≤ 36 V

EMC protection

IEC 61000-4-2 (ESD)

According to IEC 60947-5-2

- 8 KV air discharge,
- 4 KV contact discharge

12 V/m
4 kV
10 V
30 A/m

MTTF_d

850 years @ 50°C (122°F)

Dimensions (mm)

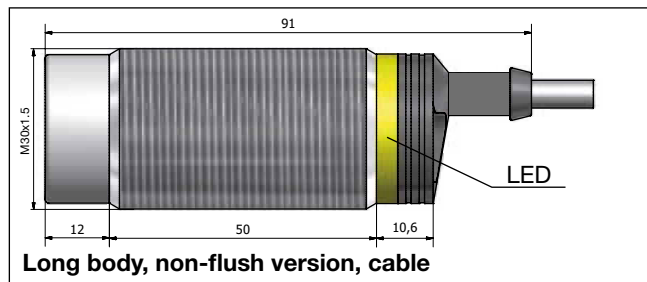
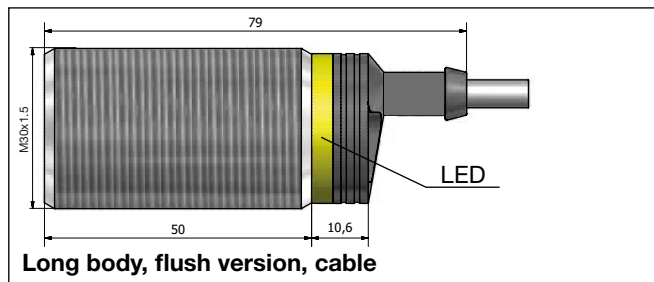
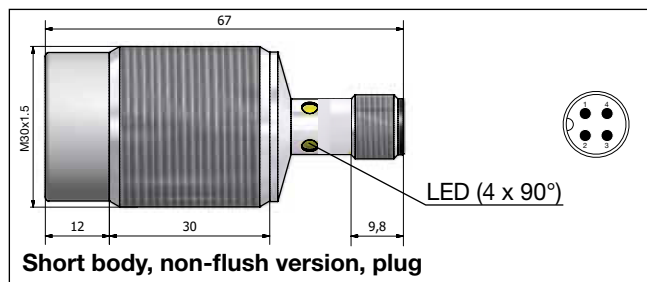
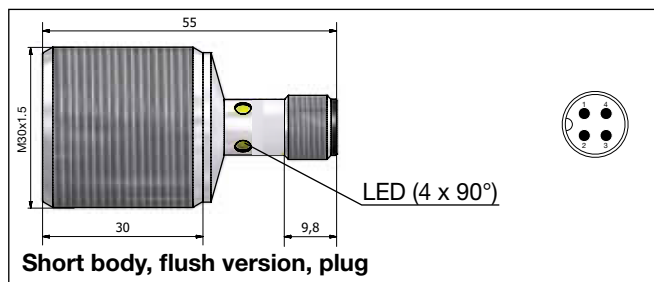
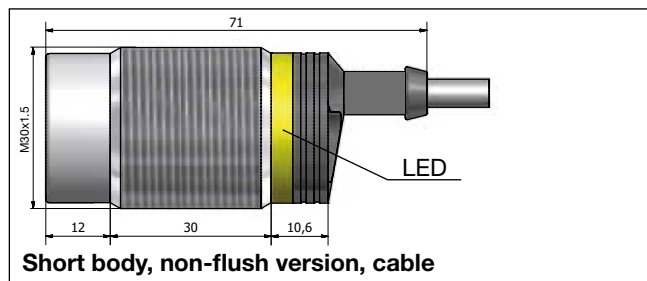
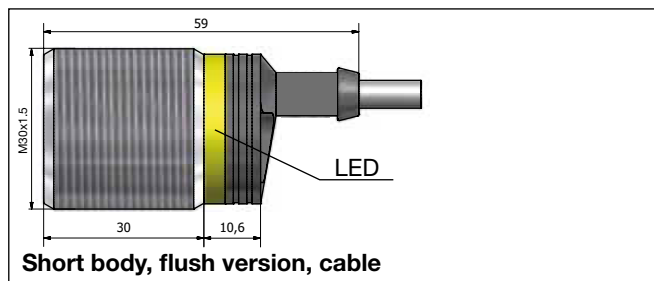

Dimensions (mm) (cont.)

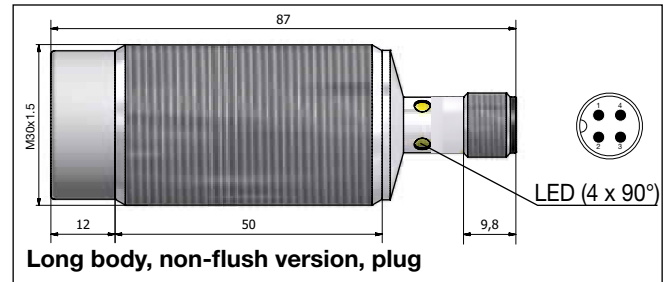
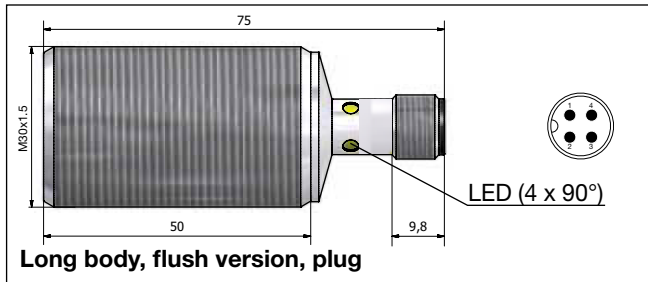

Installation

Flush sensor, when installed in damping material, must be according to Picture 1A.

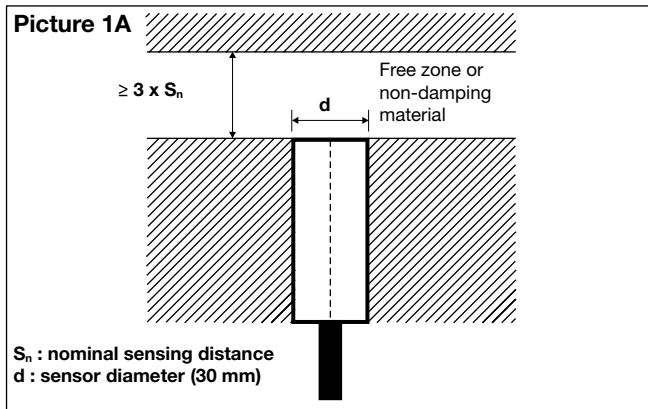

Non-flush sensor, when installed in damping material, must be according to Picture 1B.

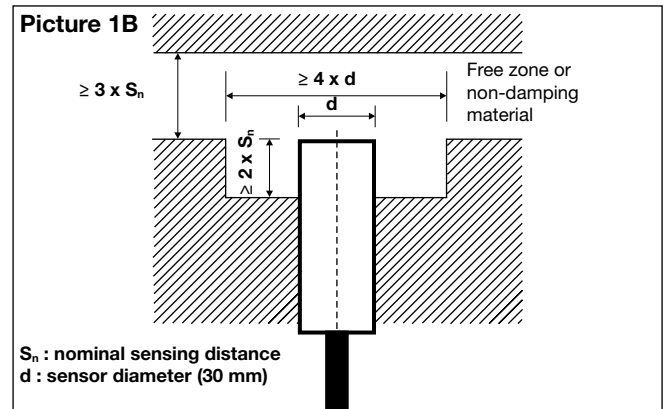

Flush sensors, when installed together in damping material, must be according to Picture 2A.

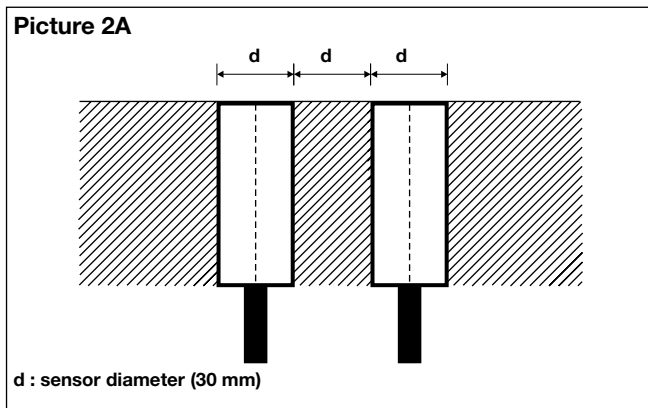

Non-flush sensors, when installed together in damping material, must be according to Picture 2B.

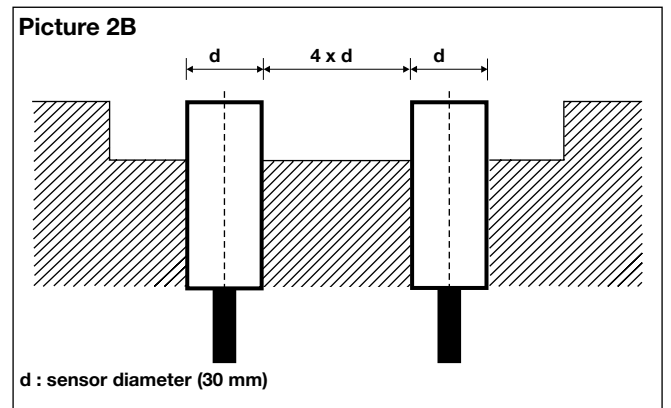

For sensors installed opposite each other, a minimum space of $6 \times S_n$ (the nominal sensing distance) must be observed (See Picture 3).

