

ICS08, ICB12, ICB18 and ICB30 4-wire DC



Proximity inductive sensors with complementary output function



Description

A complete family of high performance inductive sensors and represents Carlo Gavazzi standard solution for industrial automation equipments. It is available in 4 diameters: M8, M12, M18 and M30, in standard and extended sensing ranges, long and short rugged housings.

Benefits

- **A complete family.** Available in M8, M12, M18 and M30 housings with an operating distance from 2 to 22 mm.
- **Less machine downtime.** Lower risk of mechanical damage thanks to the extended range sensors with 2 times the standard operating distance.
- **Easy to install.** ICB sensors have a milled section for wrench grip and two different thread lengths. The user can choose between 2 m PVC cable and M12-disconnect plug versions.
- **High precision.** The onboard advanced microcontroller ensures better stability with respect to environmental influences, with highly repeatable measurements between -25 and +70°C (up to +80°C for ICS).
- **Easy customization to specific OEM requests.** Special sensing distance and timing functions or pig-tail solutions with special cables and connectors are possible on request.
- **Product traceability.** Permanently legible part number and serial number, laser engraved on the plastic cap, guarantee the traceability of every sensor.

Main functions

- Non contact detection of metal objects in general position-sensing and presence-sensing in industrial applications
- Particularly suitable for rotational speed monitoring thanks to the high operating frequency
- Simultaneous availability of both make and break switching functions with maximum connection flexibility to the control unit
- Integrated diagnostic function with flashing LED in the event of a short circuit or overload

References

Order code

 IC A

Enter the code, replacing the symbol with the selected option (e.g.: ICB12S30F04NAM1).

| Code | Option | Description |
|--------------------------|--------|---|
| I | - | Inductive sensor |
| C | - | Cylindrical housing |
| <input type="checkbox"/> | B | Nickel-plated brass housing |
| | S | Stainless steel housing |
| <input type="checkbox"/> | 08 | M8 housing |
| | 12 | M12 housing |
| | 18 | M18 housing |
| | 30 | M30 housing |
| <input type="checkbox"/> | S30 | Short housing with thread length of 30 mm |
| | L45 | Long housing with thread length of 45 mm |
| | L50 | Long housing with thread length of 50 mm |
| <input type="checkbox"/> | F | Flush |
| | N | Non-flush |
| <input type="checkbox"/> | 02 | Sensing distance: 2mm |
| | 04 | Sensing distance: 4mm |
| | 05 | Sensing distance: 5mm |
| | 08 | Sensing distance: 8mm |
| | 10 | Sensing distance: 10mm |
| | 14 | Sensing distance: 14mm |
| | 15 | Sensing distance: 15mm |
| | 22 | Sensing distance: 22mm |
| <input type="checkbox"/> | N | NPN |
| | P | PNP |
| A | - | Output: N.O. and N.C. |
| <input type="checkbox"/> | - | 2 m cable |
| | M5 | M8 plug |
| | M1 | M12 plug |

Additional characters can be used for customized versions.

Type selection

M8 Extended range

| Connection | Body style | Detection principle | Output type | Ordering no. Extended range |
|------------|------------|---------------------|-------------|-----------------------------|
| Cable | Short | Flush | NPN | ICS08S30F02NA |
| | | | PNP | ICS08S30F02PA |
| | | Non-flush | NPN | ICS08S30N04NA |
| | | | PNP | ICS08S30N04PA |
| Plug | Short | Flush | NPN | ICS08S30F02NAM5 |
| | | | PNP | ICS08S30F02PAM5 |
| | | Non-flush | NPN | ICS08S30N04NAM5 |
| | | | PNP | ICS08S30N04PAM5 |
| Cable | Long | Flush | NPN | ICS08L45F02NA |
| | | | PNP | ICS08L45F02PA |
| | | Non-flush | NPN | ICS08L45N04NA |
| | | | PNP | ICS08L45N04PA |
| Plug | Long | Flush | NPN | ICS08L45F02NAM5 |
| | | | PNP | ICS08L45F02PAM5 |
| | | Non-flush | NPN | ICS08L45N04NAM5 |
| | | | PNP | ICS08L45N04PAM5 |

M12 Standard and extended range

| Connection | Body style | Detection principle | Output type | Ordering no. Standard range | Ordering no. Extended range |
|------------|------------|---------------------|-------------|-----------------------------|-----------------------------|
| Cable | Short | Flush | NPN | ICB12S30F02NA | ICB12S30F04NA |
| | | | PNP | ICB12S30F02PA | ICB12S30F04PA |
| | | Non-flush | NPN | ICB12S30N04NA | ICB12S30N08NA |
| | | | PNP | ICB12S30N04PA | ICB12S30N08PA |
| Plug | Short | Flush | NPN | ICB12S30F02NAM1 | ICB12S30F04NAM1 |
| | | | PNP | ICB12S30F02PAM1 | ICB12S30F04PAM1 |
| | | Non-flush | NPN | ICB12S30N04NAM1 | ICB12S30N08NAM1 |
| | | | PNP | ICB12S30N04PAM1 | ICB12S30N08PAM1 |
| Cable | Long | Flush | NPN | ICB12L50F02NA | ICB12L50F04NA |
| | | | PNP | ICB12L50F02PA | ICB12L50F04PA |
| | | Non-flush | NPN | ICB12L50N04NA | ICB12L50N08NA |
| | | | PNP | ICB12L50N04PA | ICB12L50N08PA |
| Plug | Long | Flush | NPN | ICB12L50F02NAM1 | ICB12L50F04NAM1 |
| | | | PNP | ICB12L50F02PAM1 | ICB12L50F04PAM1 |
| | | Non-flush | NPN | ICB12L50N04NAM1 | ICB12L50N08NAM1 |
| | | | PNP | ICB12L50N04PAM1 | ICB12L50N08PAM1 |



M18 Standard and extended range

| Connection | Body style | Detection principle | Output type | Ordering no. Standard range | Ordering no. Extended range |
|------------|------------|---------------------|-------------|-----------------------------|-----------------------------|
| Cable | Short | Flush | NPN | ICB18S30F05NA | ICB18S30F08NA |
| | | | PNP | ICB18S30F05PA | ICB18S30F08PA |
| | | Non-flush | NPN | ICB18S30N08NA | ICB18S30N14NA |
| | | | PNP | ICB18S30N08PA | ICB18S30N14PA |
| Plug | Short | Flush | NPN | ICB18S30F05NAM1 | ICB18S30F08NAM1 |
| | | | PNP | ICB18S30F05PAM1 | ICB18S30F08PAM1 |
| | | Non-flush | NPN | ICB18S30N08NAM1 | ICB18S30N14NAM1 |
| | | | PNP | ICB18S30N08PAM1 | ICB18S30N14PAM1 |
| Cable | Long | Flush | NPN | ICB18L50F05NA | ICB18L50F08NA |
| | | | PNP | ICB18L50F05PA | ICB18L50F08PA |
| | | Non-flush | NPN | ICB18L50N08NA | ICB18L50N14NA |
| | | | PNP | ICB18L50N08PA | ICB18L50N14PA |
| Plug | Long | Flush | NPN | ICB18L50F05NAM1 | ICB18L50F08NAM1 |
| | | | PNP | ICB18L50F05PAM1 | ICB18L50F08PAM1 |
| | | Non-flush | NPN | ICB18L50N08NAM1 | ICB18L50N14NAM1 |
| | | | PNP | ICB18L50N08PAM1 | ICB18L50N14PAM1 |

M30 Standard and extended range

| Connection | Body style | Detection principle | Output type | Ordering no. Standard range | Ordering no. Extended range |
|------------|------------|---------------------|-------------|-----------------------------|-----------------------------|
| Cable | Short | Flush | NPN | ICB30S30F10NA | ICB30S30F15NA |
| | | | PNP | ICB30S30F10PA | ICB30S30F15PA |
| | | Non-flush | NPN | ICB30S30N15NA | ICB30S30N22NA |
| | | | PNP | ICB30S30N15PA | ICB30S30N22PA |
| Plug | Short | Flush | NPN | ICB30S30F10NAM1 | ICB30S30F15NAM1 |
| | | | PNP | ICB30S30F10PAM1 | ICB30S30F15PAM1 |
| | | Non-flush | NPN | ICB30S30N15NAM1 | ICB30S30N22NAM1 |
| | | | PNP | ICB30S30N15PAM1 | ICB30S30N22PAM1 |
| Cable | Long | Flush | NPN | ICB30L50F10NA | ICB30L50F15NA |
| | | | PNP | ICB30L50F10PA | ICB30L50F15PA |
| | | Non-flush | NPN | ICB30L50N15NA | ICB30L50N22NA |
| | | | PNP | ICB30L50N15PA | ICB30L50N22PA |
| Plug | Long | Flush | NPN | ICB30L50F10NAM1 | ICB30L50F15NAM1 |
| | | | PNP | ICB30L50F10PAM1 | ICB30L50F15PAM1 |
| | | Non-flush | NPN | ICB30L50N15NAM1 | ICB30L50N22NAM1 |
| | | | PNP | ICB30L50N15PAM1 | ICB30L50N22PAM1 |

Structure

ICS08

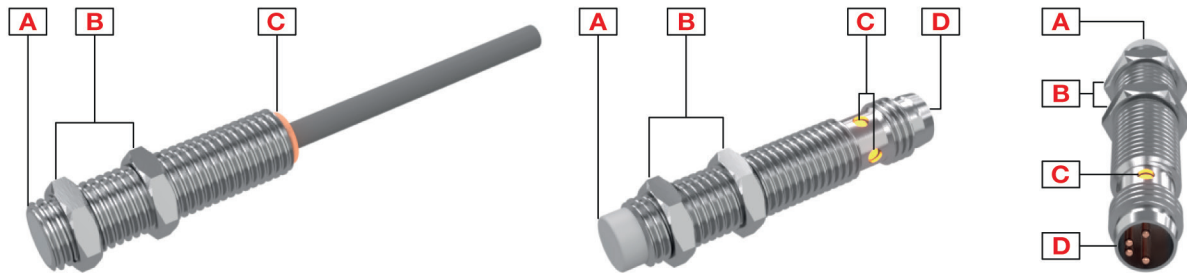

| Element | Component | Function |
|---------|---------------------------|---|
| A | Sensing face | Flush or non-flush |
| B | 2 nuts | For sensor mounting |
| C | LED | Yellow LED: Output flashing: short circuit or overload indication |
| D | M8, 4 pin, male connector | For plug versions only |

ICB12

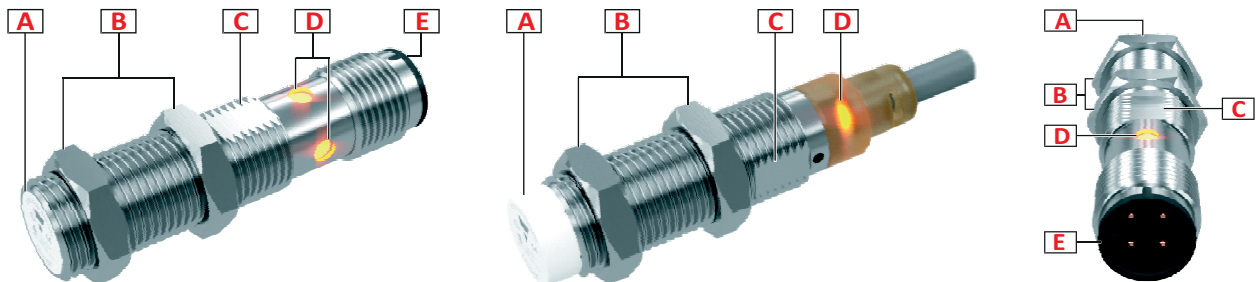

| Element | Component | Function |
|---------|--------------------------------|---|
| A | Sensing face | Flush or non-flush |
| B | 2 nuts | For sensor mounting |
| C | Milled section | For wrench grip |
| D | LED | Yellow LED: Output flashing: short circuit or overload indication |
| E | M12 x 1, 4 pin, male connector | For plug versions only |

ICB18

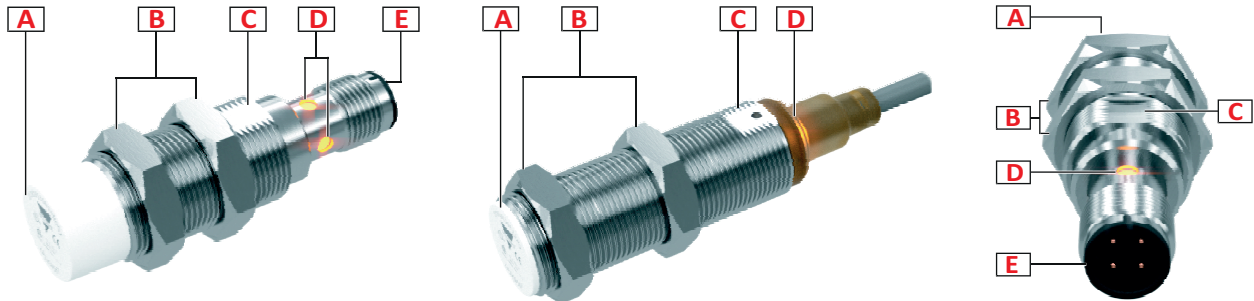

| Element | Component | Function |
|---------|--------------------------------|---|
| A | Sensing face | Flush or non-flush |
| B | 2 nuts | For sensor mounting |
| C | Milled section | For wrench grip |
| D | LED | Yellow LED: Output flashing: short circuit or overload indication |
| E | M12 x 1, 4 pin, male connector | For plug versions only |

ICB30

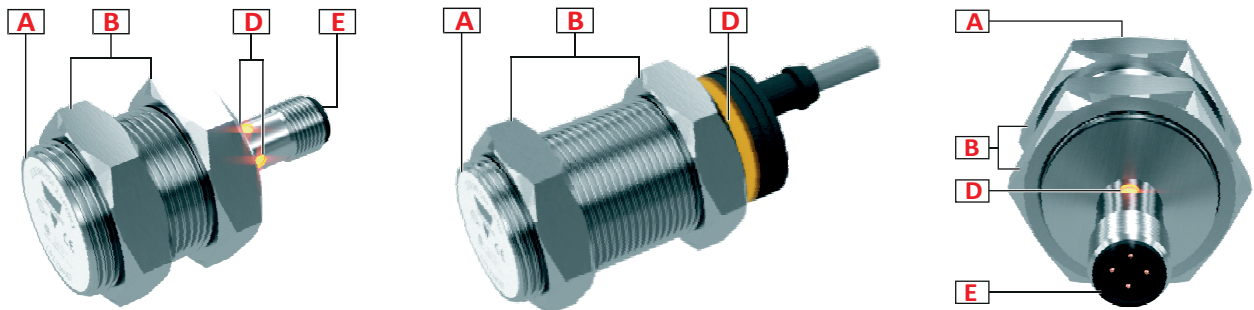

| Element | Component | Function |
|---------|--------------------------------|---|
| A | Sensing face | Flush or non-flush |
| B | 2 nuts | For sensor mounting |
| D | LED | Yellow LED: Output flashing: short circuit or overload indication |
| E | M12 x 1, 4 pin, male connector | For plug versions only |

Sensing

Detection

| | |
|--|---|
| Rated operating distance S_n | 2 to 22 mm: depending on housing diameter and version (flush or non-flush; standard or extended range) |
| Reference target | The operating distance is measured according to IEC 60947-5-2, using a standard target moving axially. This target is square shape 1 mm thickness, made of steel e.g. type Fe 360 as defined in ISO 630 and it shall be of the rolled finish. The length of the side of the square is equal to – the diameter of the circle inscribed on the active surface of the sensing face, or – three times the rated operating distance S_n whichever is greater |
| Assured operating sensing distance (S_a) | $0 \leq S_a \leq 0.81 \times S_n$ (e.g. with S_n of 15 mm, S_a is 0 ... 12.15 mm) |
| Effective operating distance (S_r) | $0.9 \times S_n \leq S_r \leq 1.1 \times S_n$ |
| Usable operating distance (S_u) | $0.9 \times S_r \leq S_u \leq 1.1 \times S_r$ |
| Hysteresis (H) | 1...20% |

Correction factors

The specific operating distance S_n refers to defined measuring conditions. The following data have to be considered as general guidelines.

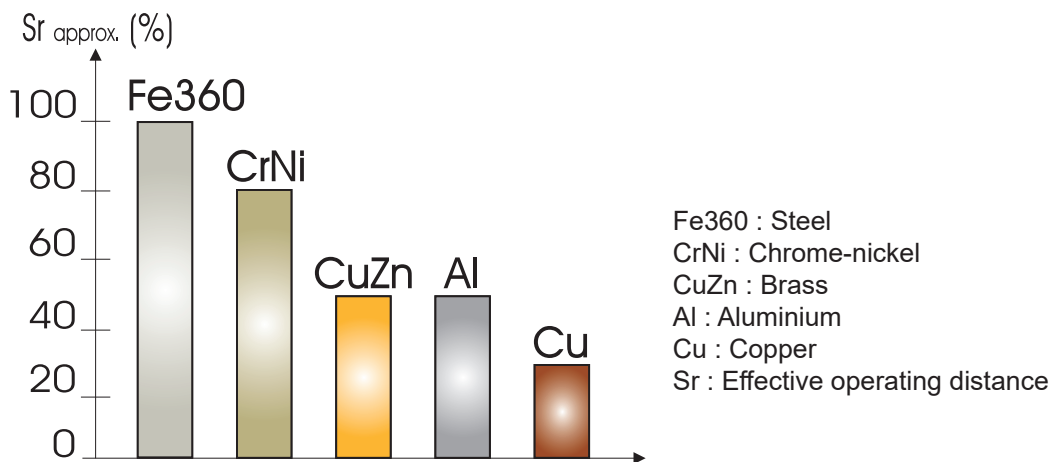

Fig. 1 The rated operating distance is reduced by the use of metals and alloys other than Fe360. The most important reduction factors for inductive proximity sensors are shown in the figure.

Accuracy

| | |
|----------------------------|--|
| Repeat accuracy (R) | ICB: $\leq 10\%$ ICS: $< 5\%$ (S_n) |
|----------------------------|--|

Features

Power Supply

| | |
|-------------------------------------|--|
| Rated operational voltage (U_b) | 10 to 36 VDC (ripple included) |
| Ripple (U_{rpp}) | $\leq 10\%$ |
| No load supply current (I_o) | ICB: ≤ 16 mA ICS: ≤ 15 mA |
| Power ON delay (t_o) | ICB: ≤ 50 ms ICS: ≤ 20 ms |

Outputs

| | | |
|-----------------------------|--|----------------|
| Output functions | NPN or PNP by sensor type | Open collector |
| Output configuration | N.O. and N.C. | Complementary |
| Output current (I_o) | ≤ 200 mA @ 50°C ; ≤ 150 mA @ $50\dots70^\circ\text{C}$ | |
| OFF-state current (I_o) | ≤ 50 μA | |
| Voltage drop (U_d) | ICB: Max. 2.5 VDC @ 200 mA ICS: Max. 1.6 VDC @ 200 mA | |
| Protection | Short-circuit, reverse polarity and transients | |
| Voltage transient | 1 kV/0.5 J | |

Response times

| | | |
|-------------------------|----------------|--------------|
| Operating frequency (f) | ≤ 2000 Hz | ICS08, ICB12 |
| | ≤ 1500 Hz | ICB18 |
| | ≤ 1000 Hz | ICB30 |

Indication

| Yellow LED | Output | Description |
|---------------------|--------|--|
| OFF | OFF | N.O. output, target not present N.C. output, target present |
| ON | ON | N.O. output, target present N.C. output, target not present |
| Blinking (f = 2 Hz) | | Short-circuit or overload |

Environmental

| | | |
|--|---|-----------------------|
| Ambient temperature ICS | Operating: -25° to +80°C, (-13° to +176°F) | |
| | Storage: -30° to +80°C (-22° to +176°F) | |
| Ambient temperature ICB | Operating: -25° to +70°C (-13° to +158°F) | |
| | Storage: -30° to +80°C (-22° to +176°F) | |
| Ambient temperature ICB30 plug version only | Operating: -40° to +70°C (-40° to +158°F) | |
| | Storage: -40° to +80°C (-40° to +176°F) | |
| Vibration | 10 to 55 Hz, amplitude 1.0 mm; sweep cycle 5 min; in X, Y and Z direction | IEC 60068-2-6 |
| Shock | 30 G /11 ms. 10 shocks in X, Y and Z direction | IEC 60068-2-27 |
| Degree of protection | IP67 | IEC 60529; EN 60947-1 |

Compatibility and conformity

| | | |
|-------------------------|--|--|
| EMC protection | IEC 61000-4-2 Electrostatic discharge | 8 kV air discharge 4 kV contact discharge |
| | IEC 61000-4-3 Radiated radiofrequency | 3 V/m |
| | IEC 61000-4-4 Burst immunity | 2 kV |
| | IEC 61000-4-6 Conducted radio frequency | 3 V |
| | IEC 61000-4-8 Power frequency magnetic fields | 30 A/m |
| MTTF_d | M8: 2813 years @ 50°C (122°F); M12: 750 years @ 50°C (122°F); M18, M30: 850 years @ 50°C (122°F) | |
| Approvals |  | |
| | CCC is not required for products rated ≤ 36 V | |

Mechanical data

| | |
|---------------------------------------|--|
| Weight (including 2 nuts) max. | Cable version: M8 49 g; M12 120 g; M18 150 g; M30 185 g Plug version: M8 19 g; M12 30 g; M18 70 g, M30 195 g |
| Mounting | Flush or non flush mountable |
| Material | ICB: Housing: Nickel-plated brass ICS: Housing: stainless steel AISI304 Front cap: Grey thermoplastic polyester |
| Max tightening torque | ICS08: 7 Nm ICB12: 10 Nm ICB18 Non-flush version: 25 Nm; Flush version: from 0 to 7 mm: 20 Nm; > 7 mm: 25 Nm ICB30: 25 Nm |



Electrical connection

| | |
|--------------|---|
| Cable | ICS: 2m grey PVC, oil proof, laser write, 4x0.14mm ² |
| | ICB12 & ICB18: 2m, 4 x 0.25 mm ² , Ø4.4 mm, PVC, grey, oil proof |
| | ICB30: 2m, 4 x 0.34 mm ² , Ø5.2 mm, PVC, grey, oil proof |
| Plug | ICS: M8 x 1, 4 pin, male connector |
| | ICB: M12 x 1, 4 pin, male connector |

Connection Diagrams

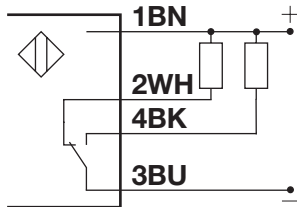

Fig. 2 NPN

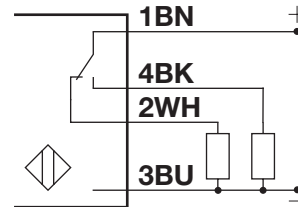

Fig. 3 PNP

| Colour code | | | | | | | |
|-------------|-------|----|-------|----|-------|----|------|
| BN | Brown | WH | White | BK | Black | BU | Blue |

Wire colors in accordance with EN 60947-5-2

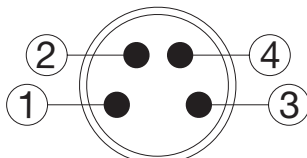

Fig. 4 ICS

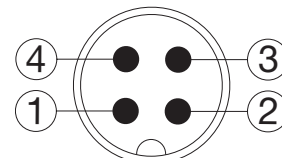

Fig. 5 ICB

Dimensions

ICS08 [mm]

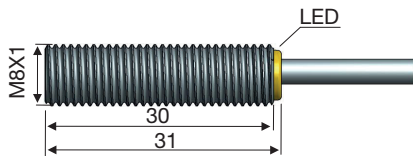

Fig. 6 Short body, flush version, cable

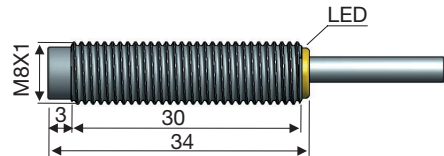

Fig. 7 Short body, non-flush version, cable

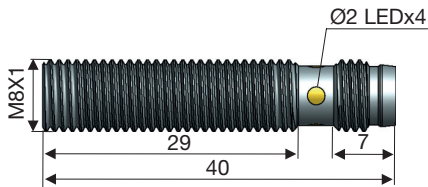

Fig. 8 Short body, flush version, plug

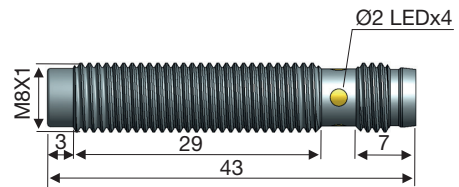

Fig. 9 Short body, non-flush version, plug

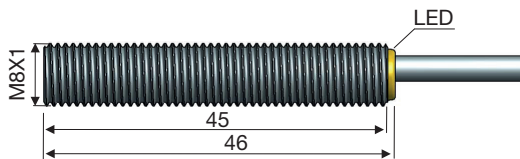

Fig. 10 Long body, flush version, cable

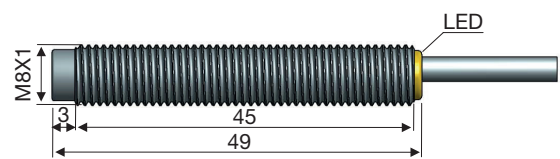

Fig. 11 Long body, non-flush version, cable

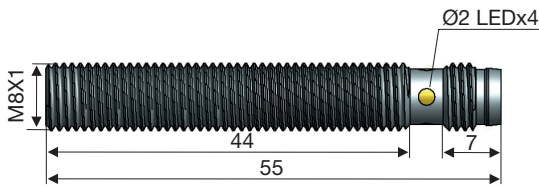

Fig. 12 Long body, flush version, plug

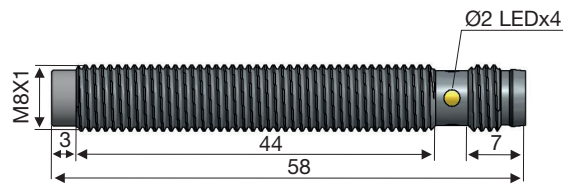

Fig. 13 Long body, non-flush version, plug

ICB12 [mm]

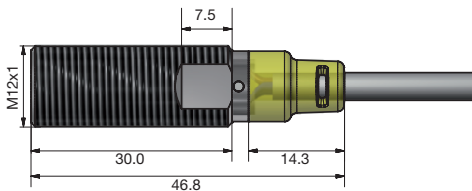

Fig. 14 Short body, flush version, cable

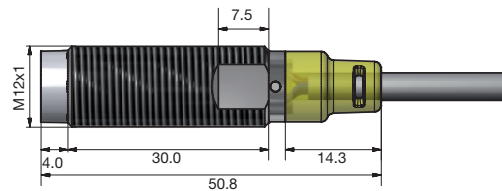

Fig. 15 Short body, non-flush version, cable

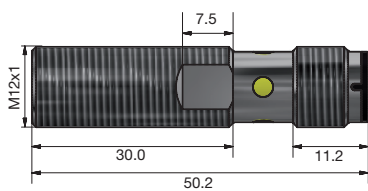

Fig. 16 Short body, flush version, plug

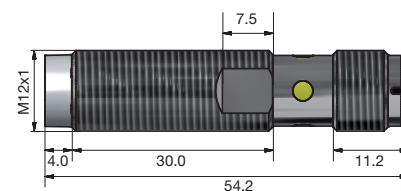

Fig. 17 Short body, non-flush version, plug

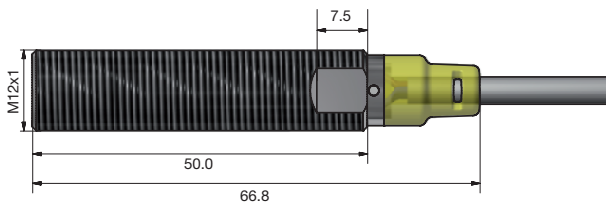

Fig. 18 Long body, flush version, cable

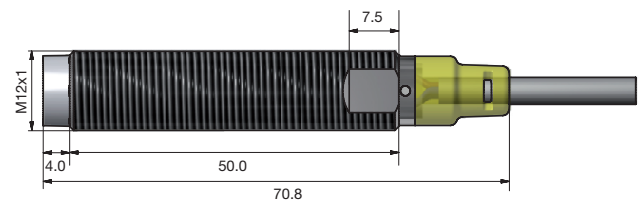

Fig. 19 Long body, non-flush version, cable

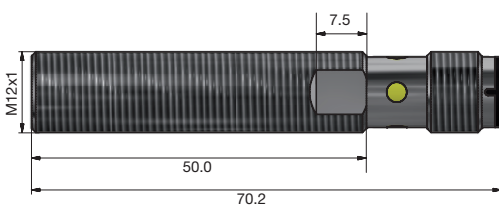

Fig. 20 Long body, flush version, plug

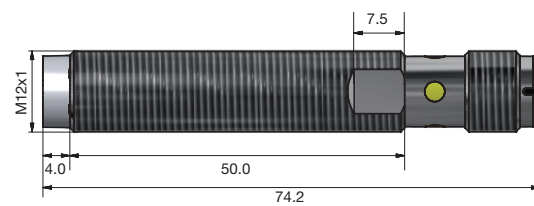

Fig. 21 Long body, non-flush version, plug

ICB18 [mm]

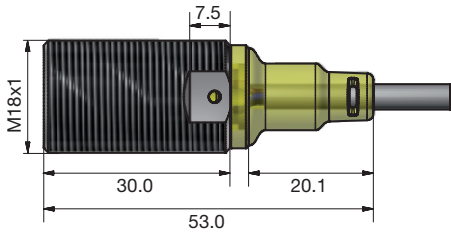

Fig. 22 Short body, flush version, cable

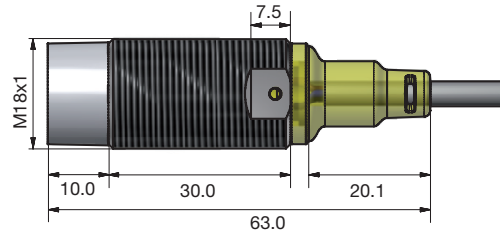

Fig. 23 Short body, non-flush version, cable

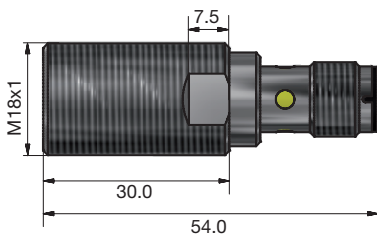

Fig. 24 Short body, flush version, plug

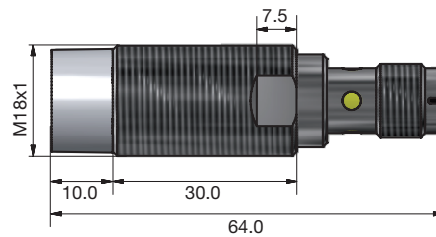

Fig. 25 Short body, non-flush version, plug

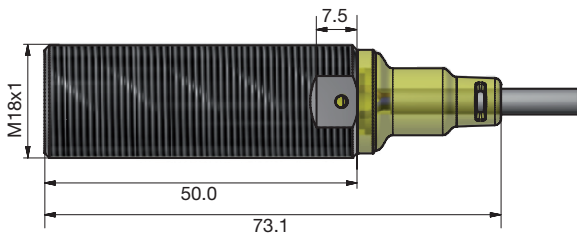

Fig. 26 Long body, flush version, cable

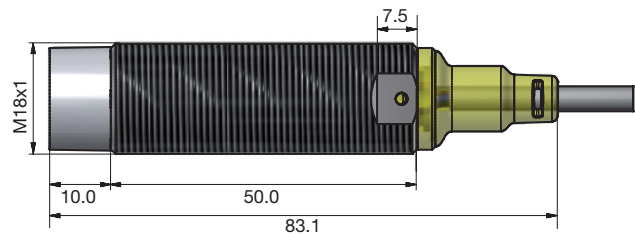

Fig. 27 Long body, non-flush version, cable

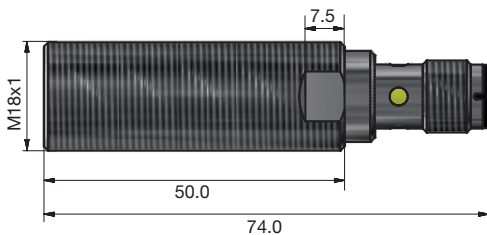

Fig. 28 Long body, flush version, plug

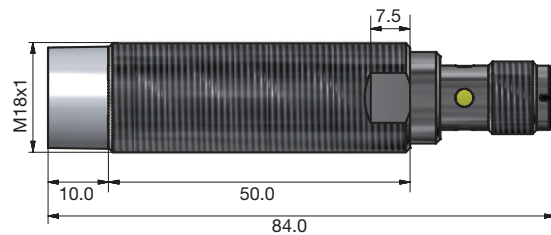

Fig. 29 Long body, non-flush version, plug

ICB30 [mm]

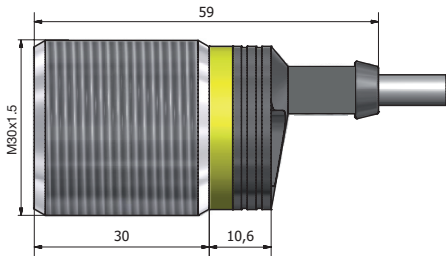

Fig. 30 Short body, flush version, cable

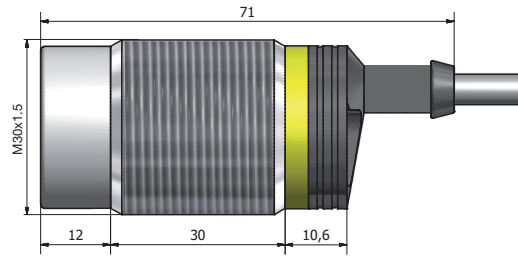

Fig. 31 Short body, non-flush version, cable

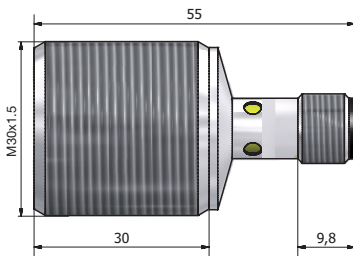

Fig. 32 Short body, flush version, plug

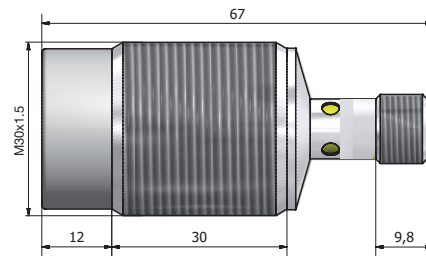

Fig. 33 Short body, non-flush version, plug

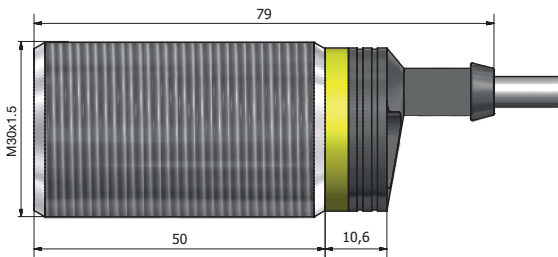

Fig. 34 Long body, flush version, cable

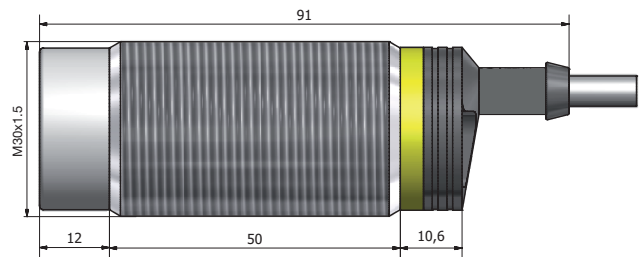

Fig. 35 Long body, non-flush version, cable

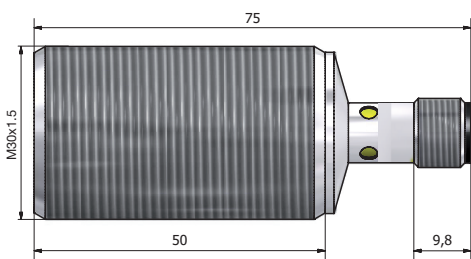

Fig. 36 Long body, flush version, plug

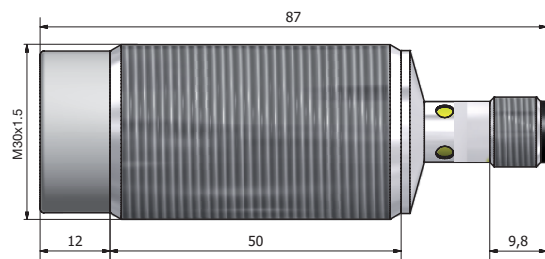

Fig. 37 Long body, non-flush version, plug

Installation

M8, M12, M18 and M30 flush

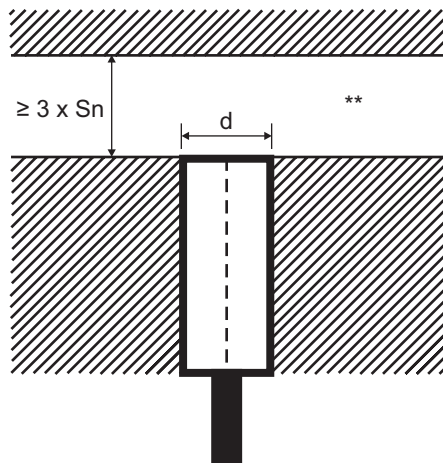

Fig. 38 Flush sensor, when installed in damping material

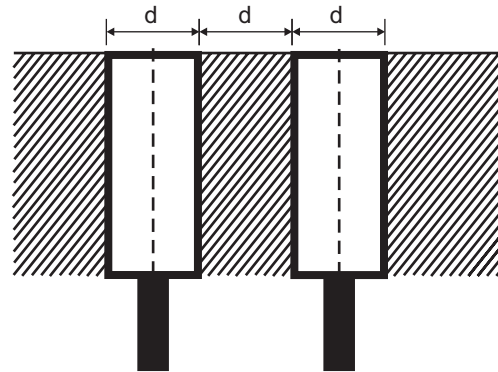

Fig. 39 Flush sensors, when installed together in damping material

M8, M12 and M18 non-flush

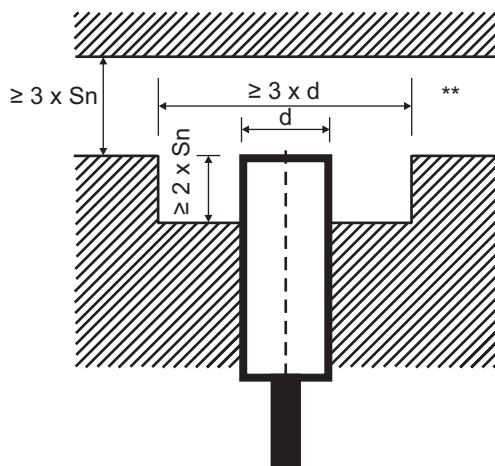

Fig. 40 Non-flush sensor, when installed in damping material

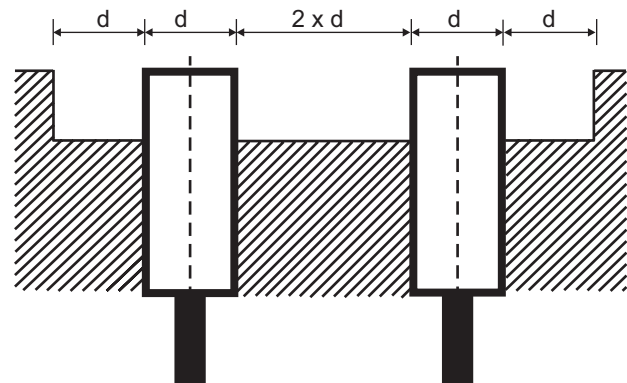

Fig. 41 Non-flush sensors, when installed together in damping material

M30 non-flush

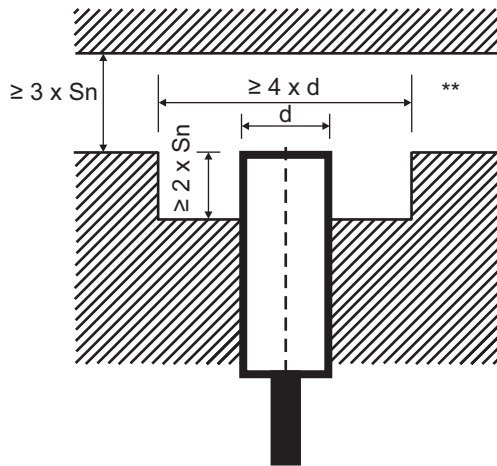

Fig. 42 Non-flush sensor, when installed in damping material

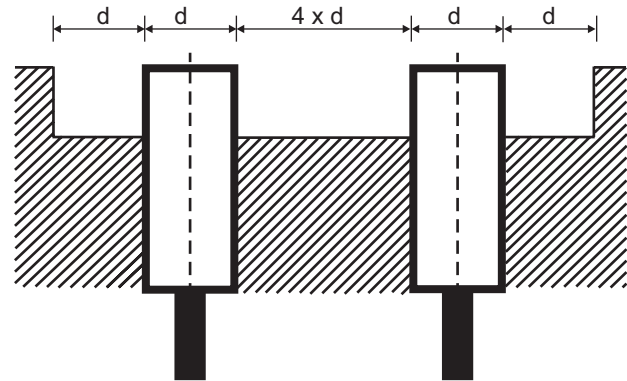

Fig. 43 Non-flush sensor, when installed together in damping material

Sensors installed opposite each other

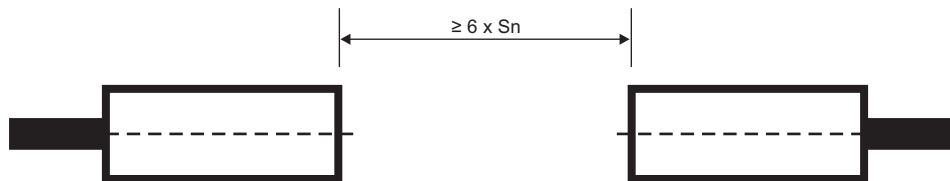

Fig. 44 For sensors installed opposite each other, a minimum space of $6 \times S_n$ (the nominal sensing distance) must be observed

** Free zone or non-damping material

S_n : nominal sensing distance

d : sensor diameter (8 mm for ICS08, 12 mm for ICB12, 18 mm for ICB18, 30 mm for ICB30)