

## IF170A, IF170B, IF170C, IF170D N-Channel JFET

### Features

- InterFET [N0132 Geometry](#)
- Low Noise: 1.0 nV/√Hz Typical
- High Gain: 24mS Typical
- Narrow Idss Ranges
- Low Cutoff Voltage: 2.0V Maximum
- RoHS Compliant
- SMT, TH, and Bare Die Package options.

### Applications

- Audio Amplifiers
- Low Noise High Gain Amplifier
- Instrumentation Amplifiers
- Acoustic and Vibration Sensors
- Replacement for 2SK170 and LSK170x
- Higher Gain Lower Ciss than Competition

### Description

The -30V InterFET IF170x JFET is targeted for sensitive amplifier stages for mid-frequencies designs. Higher breakdown voltage parts are available through InterFET custom ordering. IF389x is the dual matched part option.

TO-72 Bottom View

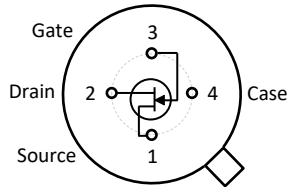

SOT23 Top View

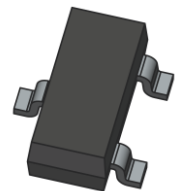
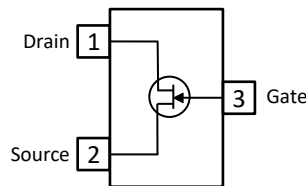

TO-92 Bottom View

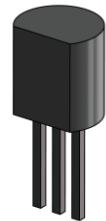
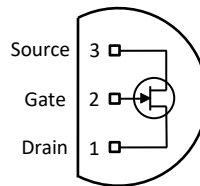

### Product Summary

Parameters	IF170A Min	IF170B Min	IF170C Min	IF170D Min	Unit
BV <sub>GSS</sub> Gate to Source Breakdown Voltage	-30	-30	-30	-30	V
I <sub>DSS</sub> Drain to Source Saturation Current	2.6	6.0	10.0	18.0	mA
V <sub>GS(off)</sub> Gate to Source Cutoff Voltage	-0.2	-0.2	-0.2	-0.2	V
G <sub>FS</sub> Full Forward Transconductance	15 (Typ)	20 (Typ)	24 (Typ)	28 (Typ)	mS

### Ordering Information

Part Number	Description	Case	Packaging
IF170AT72, IF170BT72, IF170CT72, IF170DT72	Through-Hole	TO-72	Bulk
IF170AT92, IF170BT92, IF170CT92, IF170DT92	Through-Hole	TO-92	Bulk
IF170AST3, IF170BST3, IF170CST3, IF170DST3	Surface Mount	SOT23	Bulk
IF170AST3TR, IF170BST3TR, IF170CST3TR, IF170DST3TR	7" Tape and Reel: 1,000 and 3,000 Pieces 13" Tape and Reel: 9,000 Pieces	SOT23	Minimum 1,000 Pieces Tape and Reel
IF170ACOT, IF170BCOT, IF170CCOT, IF170DCOT	Chip Orientated Tray (COT Waffle Pack)	COT	400/Waffle Pack
IF170ACFT, IF170BCFT, IF170CCFT, IF170DCFT	Chip Face-up Tray (CFT Waffle Pack)	CFT	400/Waffle Pack



**Disclaimer:** It is the Buyers responsibility for designing, validating and testing the end application under all field use cases and extreme use conditions. Guaranteeing the application meets required standards, regulatory compliance, and all safety and security requirements is the responsibility of the Buyer. These resources are subject to change without notice.

## Electrical Characteristics

### Maximum Ratings (@ T<sub>A</sub> = 25°C, Unless otherwise specified)

Parameters	Value	Unit
V <sub>RGS</sub> Reverse Gate Source and Gate Drain Voltage	-30	V
I <sub>FG</sub> Continuous Forward Gate Current	10	mA
P <sub>D</sub> Continuous Device Power Dissipation	300	mW
P Power Derating	1.8	mW/°C
T <sub>J</sub> Operating Junction Temperature	-55 to 135	°C
T <sub>STG</sub> Storage Temperature	-65 to 200	°C

### Static Characteristics (@ T<sub>A</sub> = 25°C, Unless otherwise specified)

Parameters	Conditions	Min	Max	Units
V <sub>(BR)GSS</sub> Gate to Source Breakdown Voltage	I <sub>G</sub> = -1μA, V <sub>DS</sub> = 0V	-30		V
I <sub>GSS</sub> Gate to Source Reverse Current	V <sub>DS</sub> = 0V, V <sub>GS</sub> = -10V		-0.1	nA
V <sub>GS(OFF)</sub> Gate to Source Cutoff Voltage	V <sub>DS</sub> = 10V, I <sub>D</sub> = 1nA	-0.2	-2.0	V
I <sub>DSS</sub> Drain to Source Saturation Current	V <sub>DS</sub> = 10V, V <sub>GS</sub> = 0V (Pulsed)	IF170A 2.6 IF170B 6.0 IF170C 10.0 IF170D 18.0	6.5 12.0 20.0 30.0	mA

### Dynamic Characteristics (@ T<sub>A</sub> = 25°C, Unless otherwise specified)

Parameters	Conditions	Min	Max	Units
G <sub>FS</sub> Full Forward Transconductance	V <sub>DS</sub> = 10V, V <sub>GS</sub> = 0V, f = 1kHz	14		mS
G <sub>FS(TYP)</sub> Typical Transconductance	V <sub>DS</sub> = 15V, I <sub>D</sub> = 1mA	6		mS
C <sub>iss</sub> Input Capacitance	V <sub>DS</sub> = 10V, I <sub>D</sub> = 2mA, f = 1MHz		20	pF
C <sub>rss</sub> Reverse Transfer Capacitance	V <sub>DS</sub> = 10V, I <sub>D</sub> = 2mA, f = 1MHz		4.5	pF
e <sub>n</sub> Noise Voltage	V <sub>DS</sub> = 10V, I <sub>D</sub> = 2mA, f = 1kHz	1.0 (Typical)		nV/√Hz

## Typical IF170x Characteristics

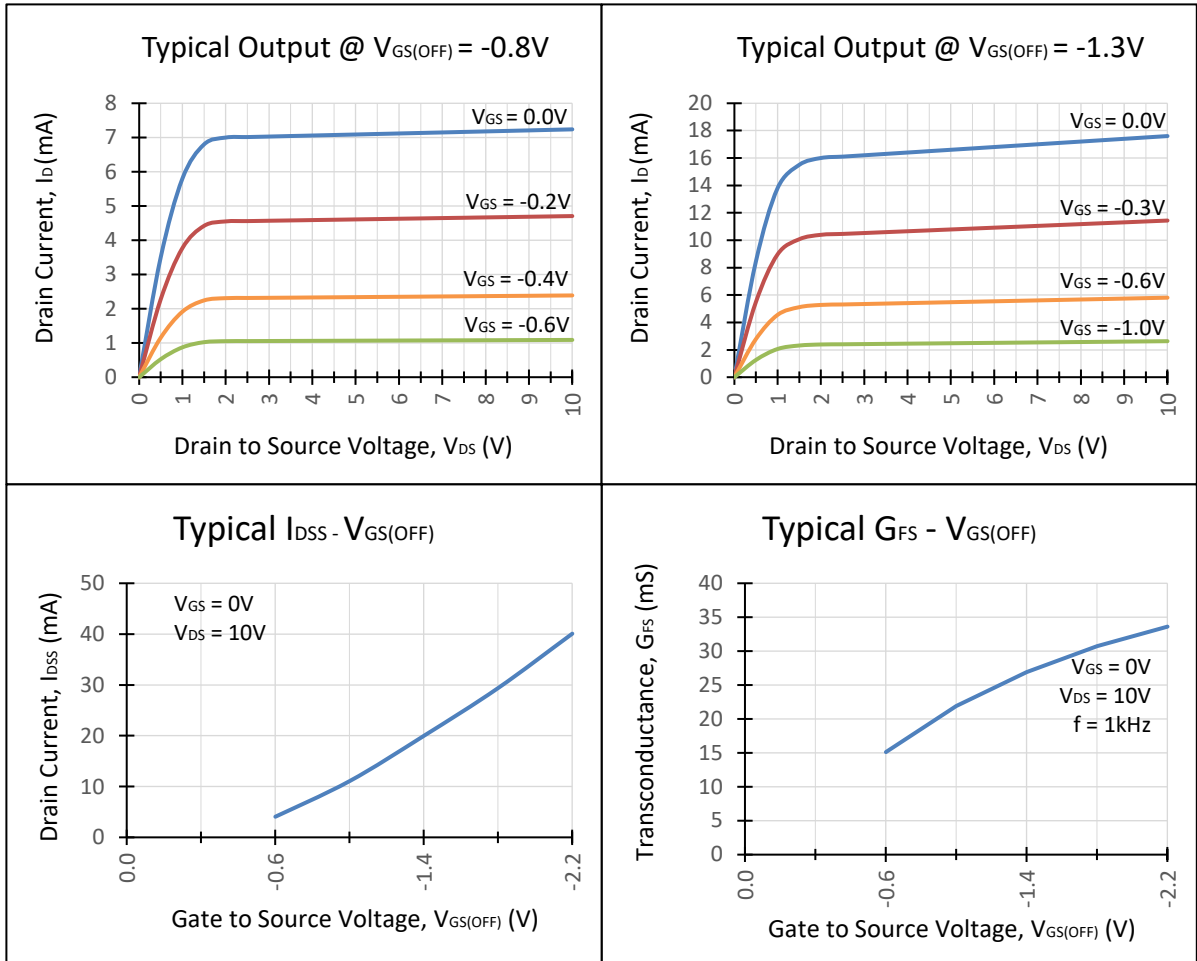

**Typical IF170x Characteristics (Continued)**

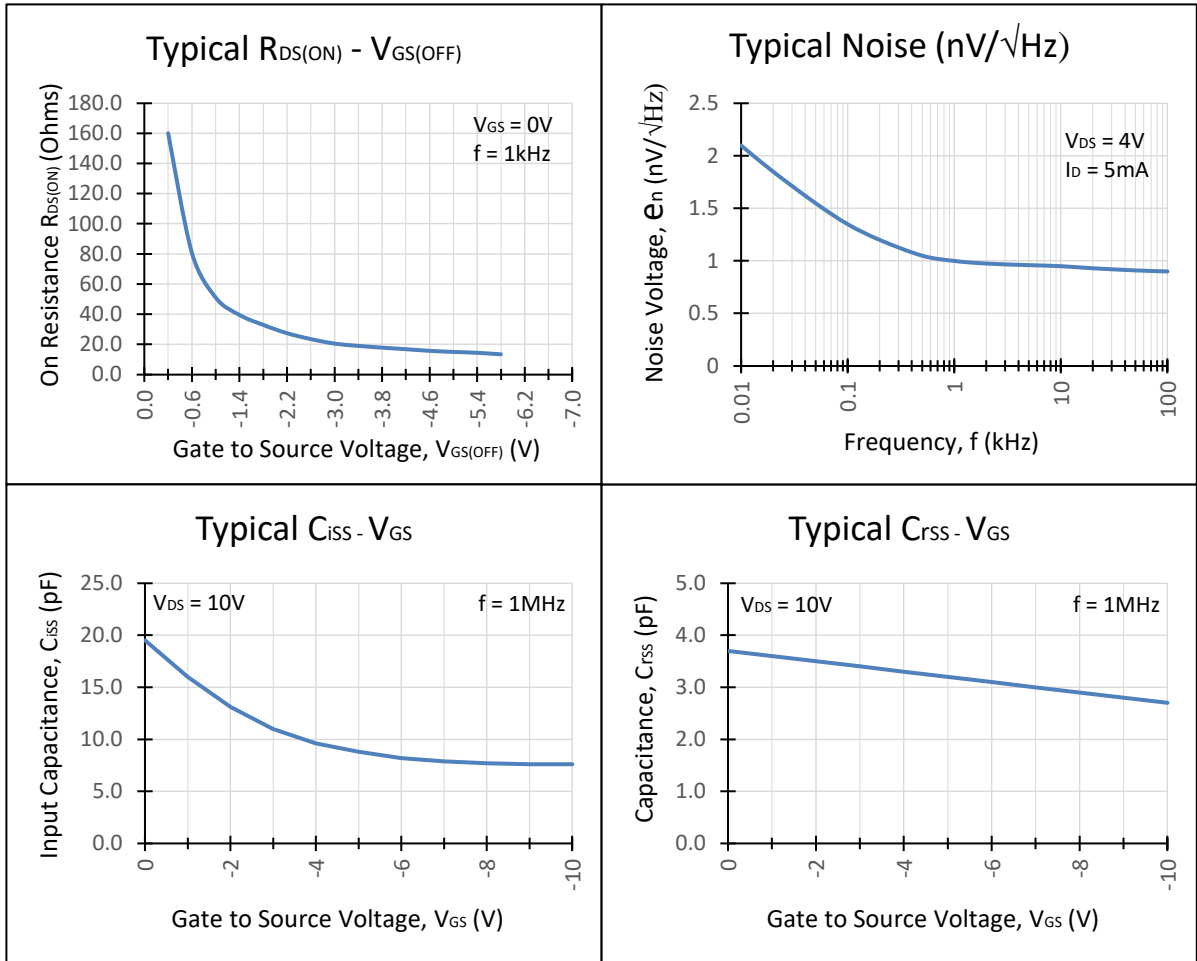

## SOT23 (TO-236AB) Mechanical and Layout Data

### Package Outline Data



1. All linear dimensions are in millimeters.
2. Package weight approximately 0.12 grams
3. Molded plastic case UL 94V-0 rated
4. For Tape and Reel specifications refer to InterFET CTC-021 Tape and Reel Specification, Document number: IF39002
5. Bulk product is shipped in standard ESD shipping material
6. Refer to JEDEC standards for additional information.

### Suggested Pad Layout



1. All linear dimensions are in millimeters.
2. The suggested land pattern dimensions have been provided for reference only. A more robust pattern may be desired for wave soldering.

## TO-72 Mechanical and Layout Data

### Package Outline Data

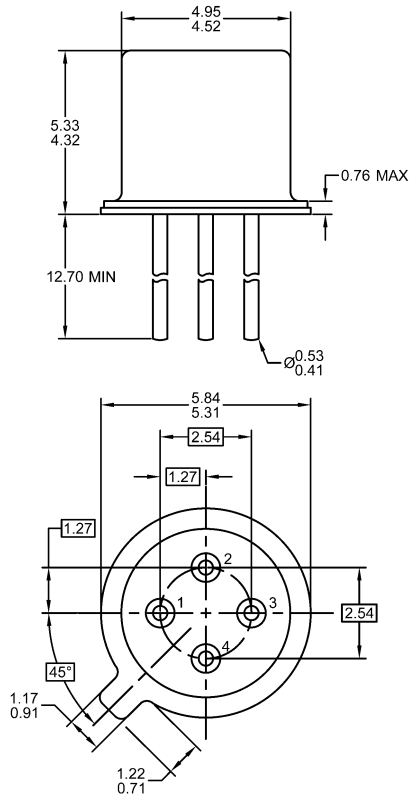

1. All linear dimensions are in millimeters.
2. Four leaded device. Not all leads are shown in drawing views.
3. Package weight approximately 0.31 grams
4. Bulk product is shipped in standard ESD shipping material
5. Refer to JEDEC standards for additional information.

### Suggested Through-Hole Layout



1. All linear dimensions are in millimeters.
2. The suggested land pattern dimensions have been provided as a straight lead reference only. A more robust pattern may be desired for wave soldering and/or bent lead configurations.