

IF389A, IF389B, IF389C, IF389D Dual Matched N-Channel JFET

Features

- InterFET [N0132 Geometry](#)
- Low Noise: 1.0 nV/√Hz Typical
- High Gain: 24mS Typical
- Low Cutoff Voltage: 2.0V Maximum
- Thermally Optimized SOIC8 Package
- RoHS Compliant
- SMT, TH, and Bare Die Package options.

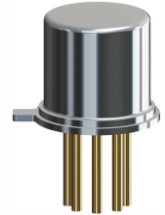
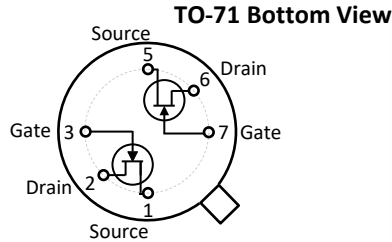

Applications

- Differential Audio Amplifiers
- Low Noise High Gain Amplifier
- Instrumentation Amplifiers
- Acoustic and Vibration Sensors
- Replacement Parts for 2SK389 and LSK389x

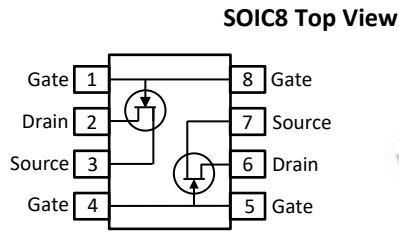

Note: The SOIC8 package is pinned out differently than the LSK389x part to optimize thermal performance. Package and pinout variations are available through InterFET custom ordering.

Description

The -30V InterFET IF389x matched pair JFET is targeted for low noise high gain differential amplifier designs. The TO-71 package is hermetically sealed and suitable for military uses. Higher breakdown voltage parts are available through InterFET custom ordering. The IF170x is a single part option.

Product Summary

Parameters	IF389A Min	IF389B Min	IF389C Min	IF389D Min	Unit
BV_{GSS} Gate to Source Breakdown Voltage	-30	-30	-30	-30	V
I_{DSS} Drain to Source Saturation Current	2.6	6.0	10.0	18.0	mA
$V_{GS(off)}$ Gate to Source Cutoff Voltage	-0.2	-0.2	-0.2	-0.2	V
G_{FS} Full Forward Transconductance	15 (Typ)	20 (Typ)	24 (Typ)	28 (Typ)	mS

Ordering Information Custom Part and Binning Options Available

Part Number	Description	Case	Packaging
IF389AT71, IF389BT71, IF389CT71, IF389DT71	Through-Hole	TO-71	Bulk
IF389AS08, IF389BS08, IF389CS08, IF389DS08	Surface Mount	SOIC8	Bulk
IF389AS08TR, IF389BS08TR, IF389CS08TR, IF389DS08TR	7" Tape and Reel: Max 500 Pieces 13" Tape and Reel: Max 2,500 Pieces	SOIC8	Minimum 500 Pieces Tape and Reel
IF389ACOT, IF389BCOT, IF389CCOT, IF389DCOT *	Chip Orientated Tray (COT Waffle Pack)	COT	70/Waffle Pack
IF389ACFT, IF389BCFT, IF389CCFT, IF389DCFT *	Chip Face-up Tray (CFT Waffle Pack)	CFT	70/Waffle Pack

* Bare die packaged options are designed for matched specifications but not 100% tested



Disclaimer: It is the Buyers responsibility for designing, validating and testing the end application under all field use cases and extreme use conditions. Guaranteeing the application meets required standards, regulatory compliance, and all safety and security requirements is the responsibility of the Buyer. These resources are subject to change without notice.

Electrical Characteristics

Maximum Ratings (@ T_A = 25°C, Unless otherwise specified)

Parameters	Value	Unit
V _{RGS} Reverse Gate Source and Gate Drain Voltage	-30	V
I _{FG} Continuous Forward Gate Current	10	mA
P _D Continuous Device Power Dissipation	300	mW
P Power Derating	1.8	mW/°C
T _J Operating Junction Temperature	-55 to 135	°C
T _{STG} Storage Temperature	-65 to 200	°C

Static Characteristics (@ T_A = 25°C, Unless otherwise specified)

Parameters	Conditions	Min	Max	Units
V _{(BR)GSS} Gate to Source Breakdown Voltage	I _G = -1μA, V _{DS} = 0V	-30		V
I _{GSS} Gate to Source Reverse Current	V _{DS} = 0V, V _{GS} = -10V		-0.1	nA
V _{GS(OFF)} Gate to Source Cutoff Voltage	V _{DS} = 10V, I _D = 1nA	-0.2	-2.0	V
I _{DSS} Drain to Source Saturation Current	V _{DS} = 10V, V _{GS} = 0V (Pulsed)	IF389A 2.6 IF389B 6.0 IF389C 10.0 IF389D 18.0	6.5 12.0 20.0 30.0	mA

Dynamic Characteristics (@ T_A = 25°C, Unless otherwise specified)

Parameters	Conditions	Min	Max	Units
G _{FS} Full Forward Transconductance	V _{DS} = 10V, V _{GS} = 0V, f = 1kHz	14		mS
G _{FS(TYP)} Typical Transconductance	V _{DS} = 15V, I _D = 1mA	6		mS
C _{iss} Input Capacitance	V _{DS} = 10V, I _D = 2mA, f = 1MHz		20	pF
C _{rss} Reverse Transfer Capacitance	V _{DS} = 10V, I _D = 2mA, f = 1MHz		4.5	pF
e _n Noise Voltage	V _{DS} = 10V, I _D = 2mA, f = 1kHz	1.0 (Typical)		nV/√Hz
V _{GS1} - V _{GS2} Differential Gate Source Voltage	V _{DS} = 10V, I _D = 1mA		30	mV

Typical IF389x Characteristics

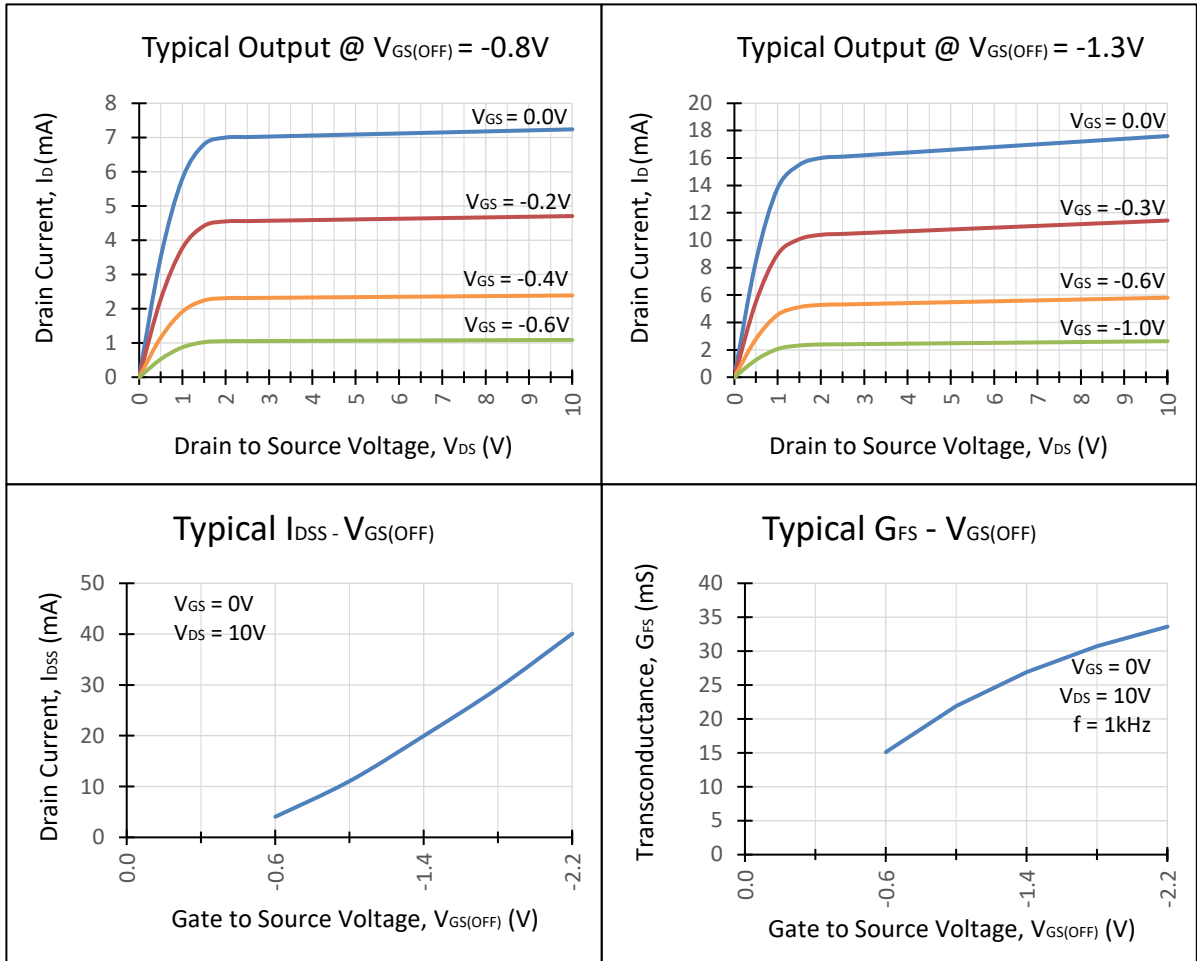

Typical IF389x Characteristics (Continued)

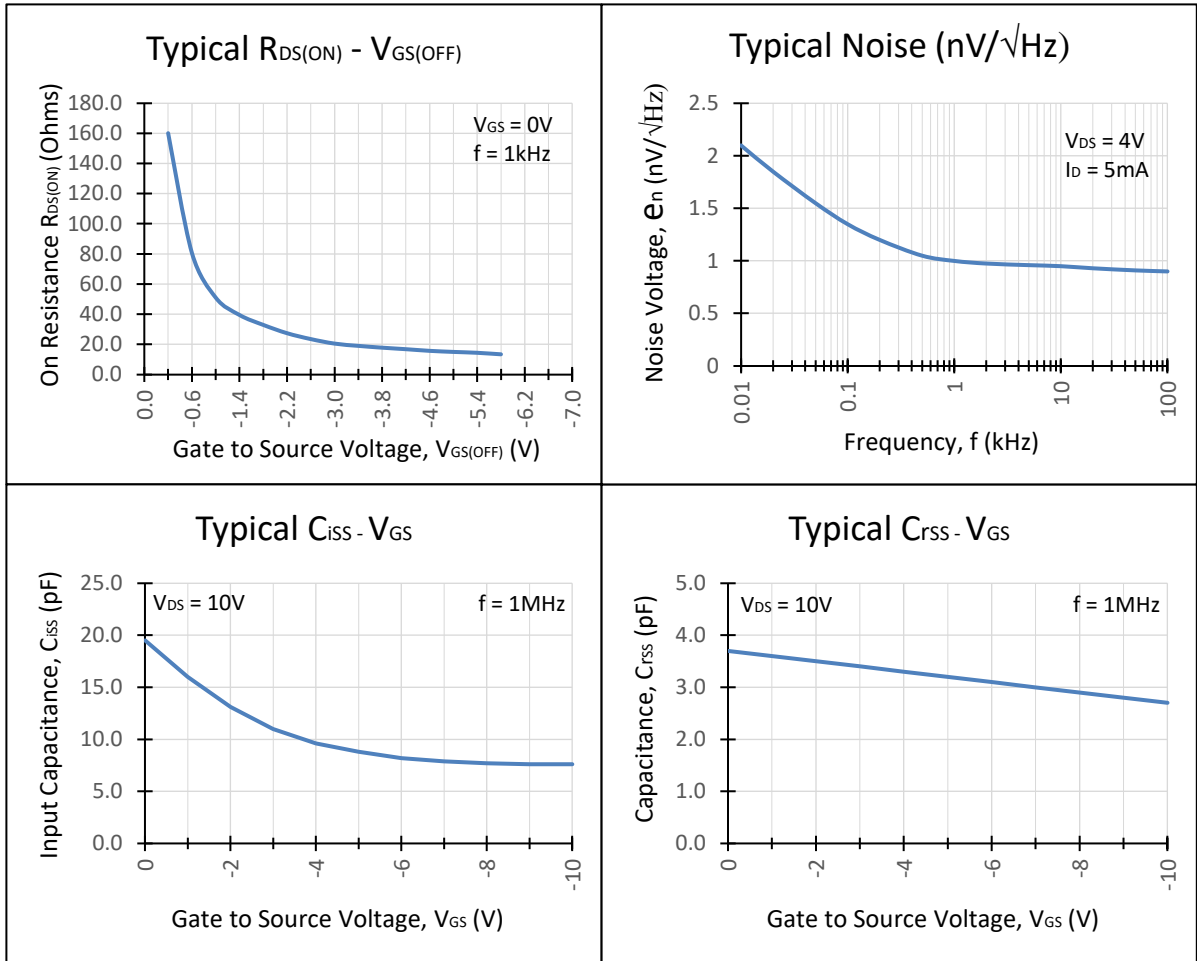

SOIC8 Mechanical and Layout Data

Package Outline Data

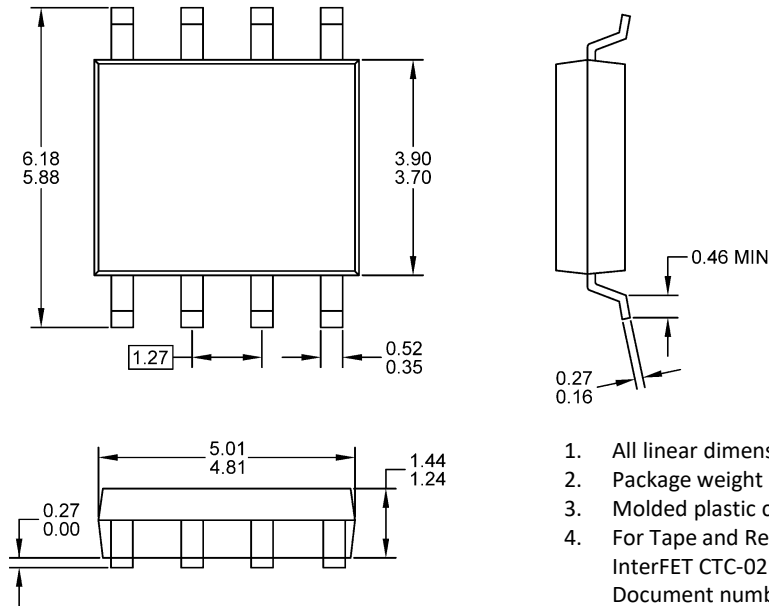

1. All linear dimensions are in millimeters.
2. Package weight approximately 0.21 grams
3. Molded plastic case UL 94V-0 rated
4. For Tape and Reel specifications refer to InterFET CTC-021 Tape and Reel Specification, Document number: IF39002
5. Bulk product is shipped in standard ESD shipping material
6. Refer to JEDEC standards for additional information.

Suggested Pad Layout

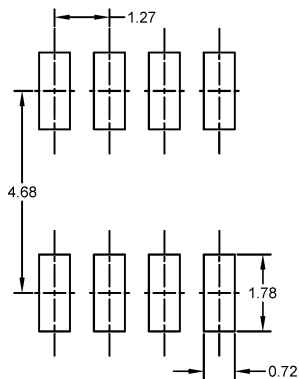

1. All linear dimensions are in millimeters.
2. The suggested land pattern dimensions have been provided for reference only. A more robust pattern may be desired for wave soldering.