

IFN147 N-Channel JFET

Features

- InterFET [N0450H Geometry](#)
- Low Noise: 1.1 nV/√Hz Typical
- High Gain: 30mS Typical
- RoHS Compliant
- SMT, TH, and Bare Die Package options.

Applications

- Low-Noise Audio Amplifier
- Replacement for Japanese 2SK147

Description

The -50V InterFET IFN147 is a low noise high gain replacement for the Japanese 2SK147 JFET. Gate leakages are typically less than 50pA at room temperatures. The TO-18 package is hermetically sealed and suitable for military applications.

TO-18 Bottom View

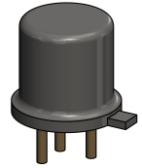
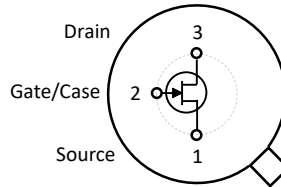

SOT23 Top View

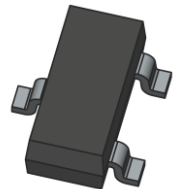
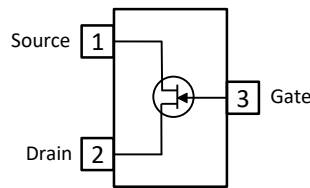

TO-92 Bottom View

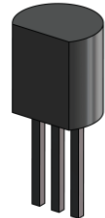
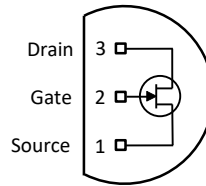

Product Summary

Parameters		IFN147 Min	Unit
BV_{GSS}	Gate to Source Breakdown Voltage	-40	V
I_{DSS}	Drain to Source Saturation Current	5	mA
$V_{GS(off)}$	Gate to Source Cutoff Voltage	-0.3	V
G_{FS}	Forward Transconductance	20	mS

Ordering Information

Part Number	Description	Case	Packaging
IFN147	Through-Hole	TO-18	Bulk
PN147	Through-Hole	TO-92	Bulk
SMP147	Surface Mount	SOT23	Bulk
SMP147TR	7" Tape and Reel: Max 3,000 Pieces 13" Tape and Reel: Max 9,000 Pieces	SOT23	Minimum 1,000 Pieces Tape and Reel
IFN147COT	Chip Orientated Tray (COT Waffle Pack)	COT	400/Waffle Pack
IFN147CFT	Chip Face-up Tray (CFT Waffle Pack)	CFT	400/Waffle Pack



Disclaimer: It is the Buyers responsibility for designing, validating and testing the end application under all field use cases and extreme use conditions. Guaranteeing the application meets required standards, regulatory compliance, and all safety and security requirements is the responsibility of the Buyer. These resources are subject to change without notice.

Electrical Characteristics

Maximum Ratings (@ $T_A = 25^\circ\text{C}$, Unless otherwise specified)

Parameters	Value	Unit
V_{RGS} Reverse Gate Source and Gate Drain Voltage	-40	V
I_{FG} Continuous Forward Gate Current	10	mA
P_D Continuous Device Power Dissipation	300	mW
P Power Derating	2.4	mW/ $^\circ\text{C}$
T_J Operating Junction Temperature	-55 to 125	$^\circ\text{C}$
T_{STG} Storage Temperature	-65 to 200	$^\circ\text{C}$

Static Characteristics (@ $T_A = 25^\circ\text{C}$, Unless otherwise specified)

Parameters	Conditions	IFN113		Unit
		Min	Max	
$V_{(BR)GSS}$ Gate to Source Breakdown Voltage	$V_{DS} = 0V, I_G = -1\mu\text{A}$	-40		V
I_{GSS} Gate to Source Reverse Current	$V_{GS} = -30V, V_{DS} = 0V, T_A = 25^\circ\text{C}$ $V_{GS} = -30V, V_{DS} = 0V, T_A = 150^\circ\text{C}$		-1 -1	nA μA
$V_{GS(OFF)}$ Gate to Source Cutoff Voltage	$V_{DS} = 10V, I_D = 1\mu\text{A}$	-0.3	-1.2	V
I_{DSS} Drain to Source Saturation Current	$V_{GS} = 0V, V_{DS} = 10V$ (Pulsed)	5	30	mA

Dynamic Characteristics (@ $T_A = 25^\circ\text{C}$, Unless otherwise specified)

Parameters	Conditions	IFN147			Unit
		Min	Typ	Max	
G_{FS} Forward Transconductance	$V_{DS} = 10V, V_{GS} = 0V, I_{DSS} = 5\text{mA},$ $f = 1\text{kHz}$	20	30		mS
C_{iss} Input Capacitance	$V_{DS} = 10V, V_{GS} = 0V, f = 1\text{kHz}$			75	pF
C_{rss} Reverse Transfer Capacitance	$V_{DS} = 10V, I_D = 0A, f = 1\text{kHz}$			15	pF
NF Noise Figure	$V_{DS} = 10V, I_D = 5\text{mA}, f = 1\text{kHz}$ $R_G = 100\Omega, f = 100\text{Hz}$		1	10	dB

SOT23 (TO-236AB) Mechanical and Layout Data

Package Outline Data

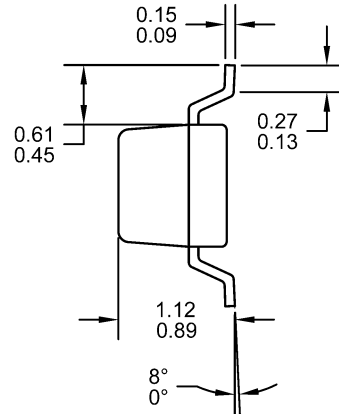

1. All linear dimensions are in millimeters.
2. Package weight approximately 0.12 grams
3. Molded plastic case UL 94V-0 rated
4. For Tape and Reel specifications refer to InterFET CTC-021 Tape and Reel Specification, Document number: IF39002
5. Bulk product is shipped in standard ESD shipping material
6. Refer to JEDEC standards for additional information.

Suggested Pad Layout



1. All linear dimensions are in millimeters.
2. The suggested land pattern dimensions have been provided for reference only. A more robust pattern may be desired for wave soldering.

TO-18 Mechanical and Layout Data

Package Outline Data

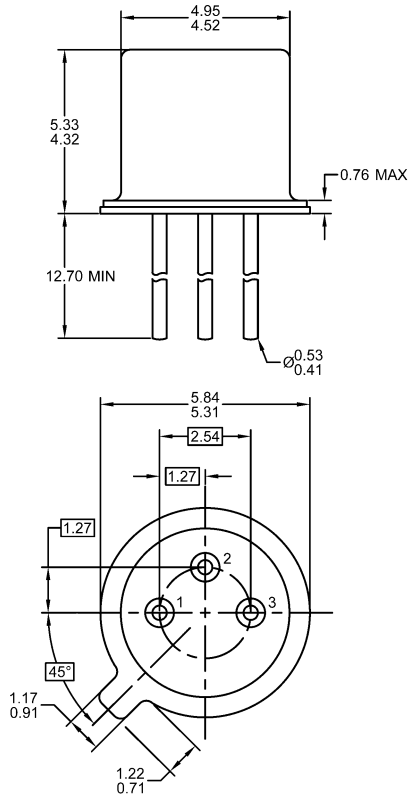

1. All linear dimensions are in millimeters.
2. Package weight approximately 0.29 grams
3. Bulk product is shipped in standard ESD shipping material
4. Refer to JEDEC standards for additional information.

Suggested Through-Hole Layout

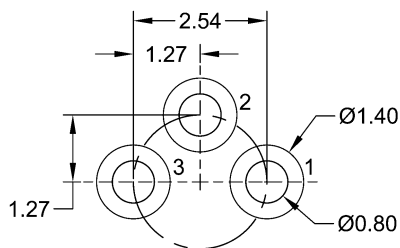

1. All linear dimensions are in millimeters.
2. The suggested land pattern dimensions have been provided as a straight lead reference only. A more robust pattern may be desired for wave soldering and/or bent lead configurations.