

High-accuracy, high-resolution, low-power, 2-axis digital inclinometer with embedded Machine Learning Core

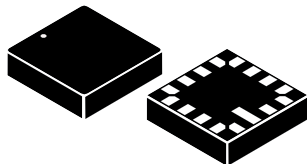

Ceramic cavity LGA-16
(5 x 5 x 1.7 mm)

Features

- 2-axis linear accelerometer
- Selectable full scale: $\pm 0.5/\pm 1/\pm 2/\pm 3$ g
- Ultra-low noise performance: $15 \mu\text{g}/\sqrt{\text{Hz}}$
- Superior stability over temperature ($<0.075 \text{ mg}/^\circ\text{C}$) and repeatability
- Embedded compensation for high stability over temperature
- I²C/SPI digital output interface
- Low power: 0.42 mA with 2 axes delivering full performance
- Sensor hub feature to efficiently collect data from additional external sensors
- Smart embedded FIFO up to 3 kbytes
- Programmable high-pass and low-pass digital filters
- Programmable Machine Learning Core to integrate AI algorithms and reduce power consumption at system level
- Programmable Finite State Machine to process data from accelerometer and one external sensor
- Extended operating temperature range (-40 °C to $+105$ °C)
- Embedded temperature sensor
- Analog supply voltage: 1.71 V to 3.6 V
- High shock survivability
- ECOPACK, RoHS and "Green" compliant

Applications

- Precision inclinometers
- Antenna pointing and platform leveling
- Structural health monitoring
- Precise leveling instruments
- Installation and monitoring of equipment
- Robotics and industrial automation

Description

The IIS2ICLX is a high-accuracy (ultra-low noise, high stability and repeatability) and low-power two-axis linear accelerometer with digital output.

The IIS2ICLX has a selectable full scale of $\pm 0.5/\pm 1/\pm 2/\pm 3$ g and is capable of providing the measured accelerations to the application over an I²C or SPI digital interface.

Its high accuracy, stability over temperature and repeatability make IIS2ICLX particularly suitable for inclination measurement applications (inclinometers).

The sensing element is manufactured using a dedicated micromachining process developed by STMicroelectronics to produce inertial sensors and actuators on silicon wafers.

The IC interface is manufactured using a CMOS process that allows a high level of integration to design a dedicated circuit which is trimmed to better match the characteristics of the sensing element.

Product status link	
IIS2ICLX	
Product summary	
Order code	IIS2ICLXTR
Temperature range [°C]	-40 to +105
Package	CC LGA-16 (5 x 5 x 1.7 mm)
Packing	Tape and reel
Product labels	
	

The IIS2ICLX has an unmatched set of embedded features (programmable FSM, Machine Learning Core, sensor hub, FIFO, event decoding and interrupts) which are enablers for implementing smart and complex sensor nodes which deliver high accuracy and performance at very low power.

The IIS2ICLX is available in a high-performance (low-stress) ceramic cavity land grid array (CC LGA) package and can operate within a temperature range of -40 °C to +105 °C.

1 Overview

The IIS2ICLX is a high-accuracy (ultra-low noise, high stability and repeatability) and ultra-low-power two-axis digital accelerometer specifically recommended for inclination measurements (inclinometers) in Industry 4.0 applications.

All design aspects and the testing and calibration of the IIS2ICLX have been optimized to reach superior accuracy, stability, repeatability and extremely low noise.

The IIS2ICLX has a selectable full scale of $\pm 0.5/\pm 1/\pm 2/\pm 3 g$ and is capable of providing the measured accelerations to the application over an I²C or SPI digital interface.

Its unique set of embedded features (programmable FSM, Machine Learning Core, sensor hub, FIFO, event decoding and interrupts) facilitate the implementation of smart and complex sensor nodes which deliver high accuracy at very low power.

Like the entire portfolio of ST MEMS sensors, the IIS2ICLX leverages the robust and mature in-house manufacturing processes already used for the production of micromachined accelerometers and gyroscopes. The various sensing elements are manufactured using specialized micromachining processes, while the IC interfaces are developed using CMOS technology that allows the design of a dedicated circuit which is trimmed to better match the characteristics of the sensing element.

The IIS2ICLX is available in a high-performance (low-stress) ceramic cavity land grid array (CC LGA) package and can operate within a temperature range of -40 °C to +105 °C.

Note: Due to the use of epoxy glue for lid sealing, hermeticity of the package is not guaranteed. Processing or use of this package in a harsh environment should be assessed by the customer.

2 Embedded low-power features

The IIS2ICLX features the following on-chip functions:

- 3 kbytes data buffering
 - 100% efficiency with flexible configurations and partitioning
 - Possibility to store timestamp and external sensors
- Event-detection interrupts (fully configurable)
 - Wakeup
 - Click and double-click sensing
 - Stationary/Motion detection
- Specific IP blocks with negligible power consumption and high-performance
 - Finite State Machine for accelerometer and external sensors
 - Machine Learning Core
- Sensor hub
 - Up to 5 total sensors: internal accelerometer and 4 external sensors

2.1 Finite State Machine

The IIS2ICLX can be configured to generate interrupt signals activated by user-defined motion patterns. To do this, up to 16 embedded finite state machines can be programmed independently for motion detection and decoding.

Definition of Finite State Machine

A state machine is a mathematical abstraction used to design logic connections. It is a behavioral model composed of a finite number of states and transitions between states, similar to a flow chart in which one can inspect the way logic runs when certain conditions are met. The state machine begins with a start state, goes to different states through transitions dependent on the inputs, and can finally end in a specific state (called stop state). The current state is determined by the past states of the system. The following figure shows a generic state machine.

Figure 1. Generic state machine

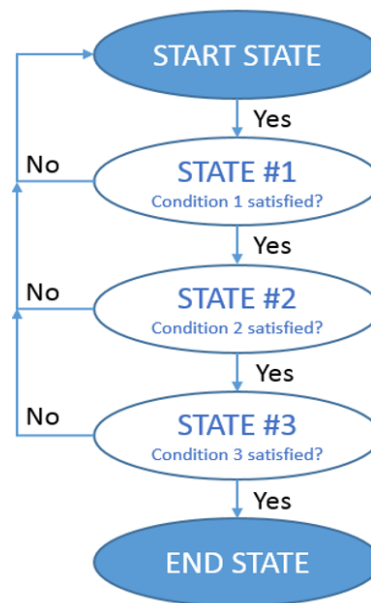

Finite State Machine in the IIS2ICLX

The IIS2ICLX works as an accelerometer sensor, generating acceleration output data. It is also possible to connect an external sensor (an accelerometer, a gyroscope, a pressure sensor etc.) by using the Sensor Hub feature (Mode 2). These data can be used as input of up to 16 programs in the embedded Finite State Machine (Figure 2. State machine in the IIS2ICLX).

All 16 finite state machines are independent: each one has its dedicated memory area and it is independently executed. An interrupt is generated when the end state is reached or when some specific command is performed.

Figure 2. State machine in the IIS2ICLX



2.2 Machine Learning Core

The IIS2ICLX embeds a dedicated core for machine learning processing that provides system flexibility, allowing some algorithms run in the application processor to be moved to the MEMS sensor with the advantage of consistent reduction in power consumption.

Machine Learning Core logic allows identifying if a data pattern (for example motion, pressure, temperature, magnetic data, etc.) matches a user-defined set of classes. Typical examples of applications could be anomalous vibration recognition, complex movement or condition identification, activity detection, etc.

The IIS2ICLX Machine Learning Core works on data patterns coming from the accelerometer, but it is also possible to connect and process external sensor data (from a gyroscope or additional external inclinometer/ accelerometer, temperature or pressure sensors) by using the Sensor Hub feature (Mode 2).

The input data can be filtered using a dedicated configurable computation block containing filters and features computed in a fixed time window defined by the user.

Machine learning processing is based on logical processing composed of a series of configurable nodes characterized by "if-then-else" conditions where the "feature" values are evaluated against defined thresholds.

Figure 3. Machine Learning Core in the IIS2ICLX

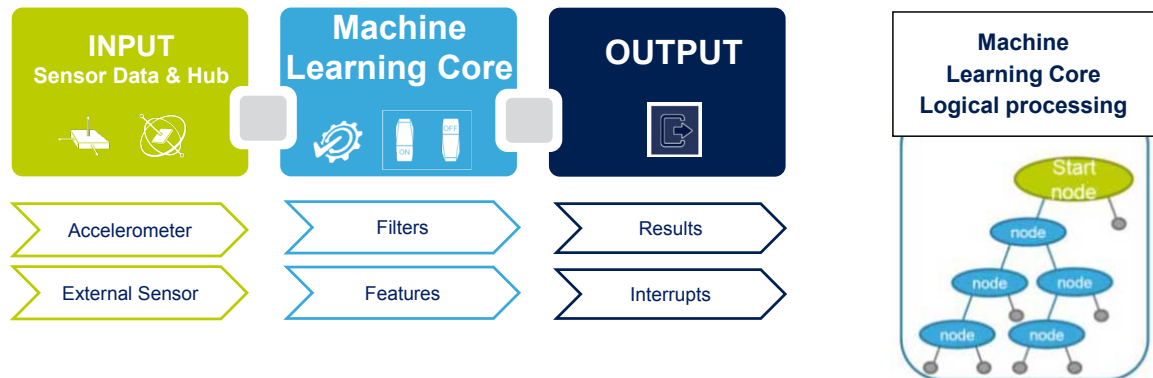

The IIS2ICLX can be configured to run up to 8 flows simultaneously and independently and every flow can generate up to 256 results. The total number of nodes can be up to 512.

The results of the machine learning processing are available in dedicated output registers readable from the application processor at any time.

The IIS2ICLX Machine Learning Core can be configured to generate an interrupt when a change in the result occurs.

3 Pin description

Figure 4. Pin connections

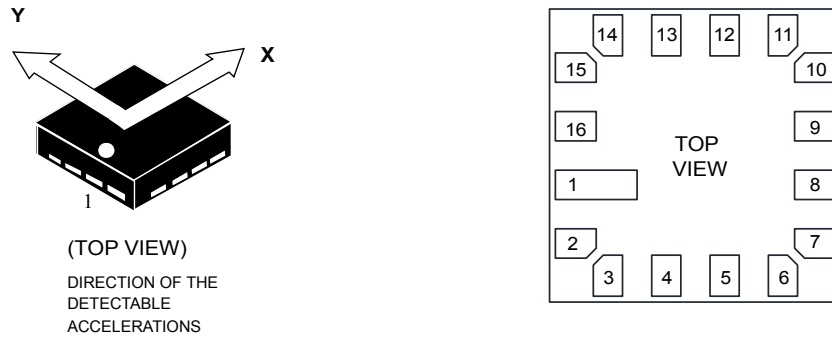

3.1 Pin connections

The IIS2ICLX offers flexibility to connect the pins in order to have two different mode connections and functionalities. In detail:

- **Mode 1:** I²C slave interface or SPI (3- and 4-wire) serial interface is available;
- **Mode 2:** I²C slave interface or SPI (3- and 4-wire) serial interface and I²C interface master for external sensor connections are available.

Figure 5. IIS2ICLX connection modes

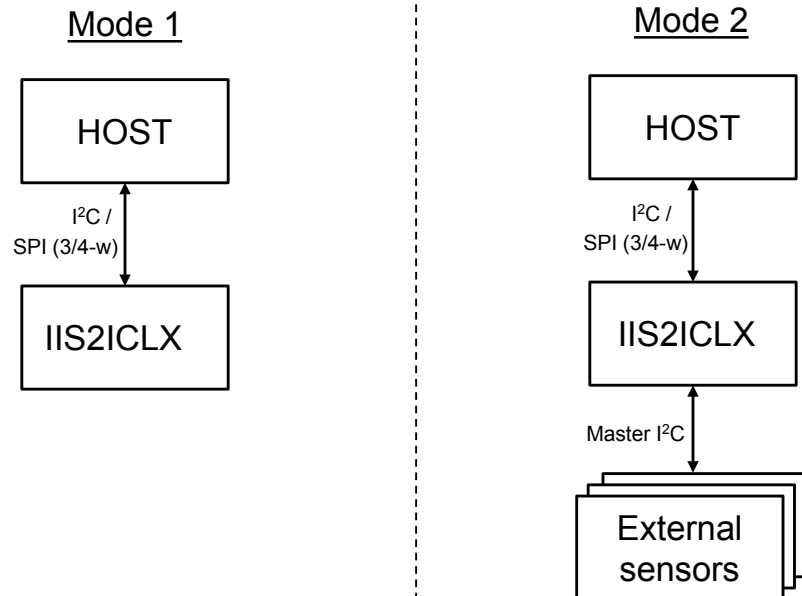

In the following table each mode is described for the pin connections and function.

Table 1. Pin description

Pin number	Name	Mode 1 function	Mode 2 function
1	VDD_IO	Power supply for I/O pins (recommended 100 nF filter capacitor)	
2	CS	I ² C/SPI mode selection (1: SPI idle mode / I ² C communication enabled; 0: SPI communication mode / I ² C disabled and reset)	
3	GND	0 V supply	
4	INT2	Programmable interrupt 2 (INT2) / Data enable (DEN)	Programmable interrupt 2 (INT2) / Data enable (DEN)/I ² C master external synchronization signal (MDRDY)
5	SDO/SA0	SPI 4-wire serial data output (SDO) I ² C least significant bit of the device address (SA0)	
6	INT1	Programmable Interrupt 1 (INT1)	
7	SDx	Connect to GND or VDD_IO	I ² C serial data master (MSDA)
8	VDD	Power supply (recommended 100 nF filter capacitor)	
9	VDD	Power supply (recommended 100 nF filter capacitor)	
10	SCL	I ² C serial clock (SCL) SPI serial port clock (SPC)	
11	SDA/SDI	I ² C serial data (SDA) SPI serial data input (SDI) 3-wire interface serial data output (SDO)	
12	SCx	Connect to GND or VDD_IO	I ² C serial clock master (MSCL)
13	GND	GND	
14	NC	Connect to GND or leave unconnected	
15	NC	Connect to GND or leave unconnected	
16	NC	Connect to GND or leave unconnected	

4 Module specifications

4.1 Mechanical characteristics

@ Vdd = 3.0 V, T = 25 °C, unless otherwise noted.

Table 2. Mechanical characteristics

Symbol	Parameter	Test conditions	Min. ⁽¹⁾	Typ. ⁽²⁾	Max. ⁽¹⁾	Unit
FS	Measurement range			±0.5		g
				±1.0		
				±2.0		
				±3.0		
So	Sensitivity ⁽³⁾	FS = ±0.5	-2%	0.015	+2%	mg/LSB
		FS = ±1.0		0.031		
		FS = ±2.0		0.061		
		FS = ±3.0		0.122		
So_acc	Sensitivity change over life ⁽⁴⁾		-1.5	±0.7	+1.5	%
TCSO	Sensitivity change vs. temperature	From -40° to +105°C, delta from 25 °C	-0.012	±0.01	+0.012	%/°C
Off	Zero-g level offset accuracy ⁽⁵⁾		-8		+8	mg
Off_acc	Zero-g level change over life ⁽⁴⁾		-2.5	±1	+2.5	mg
TCOFF	Zero-g level change vs. temperature	From -40° to +105°C, delta from 25 °C	-0.075	±0.020	+0.075	mg/°C
NL	Non-linearity	Best-fit straight line		0.1		% FS
An	Zero-g noise density			15	30	µg/√Hz
ODR	Digital output data rate			12.5		Hz
				26		
				52		
				104		
				208		
				416		
				833		
Bw	Bandwidth	@ODR 833 Hz		260		Hz
VRE	Vibration rectification error	FS = ±2 g; ODR = 50 Hz; 2.5 grms vibration in 50 - 2000 Hz band		1		mg
F0	Sensor resonant frequency			900		Hz
ST	Self-test	@FS = ±2 g	1		15	mg
Top	Operating temperature range		-40		+105	°C

1. Min/Max values are based on characterization results at 3σ on a limited number of samples, not tested in production and not guaranteed.
2. Typical specifications are not guaranteed.
3. Sensitivity range after MSL3 preconditioning.
4. Drift over life assessed based on behavior after 1000h of THS (Temperature Humidity Storage) at T=+85°C / RH = 85%.
5. Typical zero-g level offset value after MSL3 preconditioning.

4.2 Electrical characteristics

@ Vdd = 3.0 V, T = 25 °C, unless otherwise noted.

Table 3. Electrical characteristics

Symbol	Parameter	Test conditions	Min. ⁽¹⁾	Typ. ⁽²⁾	Max. ⁽¹⁾	Unit
Vdd	Supply voltage		1.71	1.8	3.6	V
Vdd_IO	I/O pins supply voltage		1.62		3.6	V
Idd	Current consumption			420		µA
IddPD	Current consumption during power-down			3		µA
Ton	Turn-on time			15		ms
V _{IH}	Digital high-level input voltage		0.7 *Vdd_IO			V
V _{IL}	Digital low-level input voltage				0.3 *Vdd_IO	V
V _{OH}	High-level output voltage	I _{OH} = 4 mA ⁽³⁾	VDD_IO - 0.2			V
V _{OL}	Low-level output voltage	I _{OL} = 4 mA ⁽³⁾			0.2	V
Top	Operating temperature range		-40		+105	°C

1. Min/Max values are based on characterization results at 3σ on a limited number of samples, not tested in production and not guaranteed.
2. Typical specifications are not guaranteed.
3. 4 mA is the maximum driving capability, i.e. the maximum DC current that can be sourced/sunk by the digital pad in order to guarantee the correct digital output voltage levels V_{OH} and V_{OL}.

4.3 Temperature sensor characteristics

@ Vdd = 3.0 V, T = 25 °C unless otherwise noted.

Table 4. Temperature sensor characteristics

Symbol	Parameter	Test conditions	Min.	Typ. ⁽¹⁾	Max.	Unit
TODR	Temperature refresh rate			52		Hz
Toff	Temperature offset ⁽²⁾		-15		+15	°C
Tsens	Temperature sensitivity			256		LSB/°C
TST	Temperature stabilization time ⁽³⁾				500	µs
T_ADC_res	Temperature ADC resolution			16		bit
Top	Operating temperature range		-40		+105	°C

1. Typical specifications are not guaranteed.
2. The output of the temperature sensor is 0 LSB (typ.) at 25 °C. Absolute temperature accuracy can be improved (reducing the effect of temperature offset) by performing OPC (one-point calibration) at room temperature (25 °C).
3. Time from power ON to valid data based on characterization data.

4.4 Communication interface characteristics

4.4.1 SPI - serial peripheral interface

Subject to general operating conditions for Vdd and Top.

Table 5. SPI slave timing values (in mode 3)

Symbol	Parameter	Value ⁽¹⁾		Unit
		Min	Max	
$t_{c(SPC)}$	SPI clock cycle	100		ns
$f_{c(SPC)}$	SPI clock frequency		10	MHz
$t_{su(CS)}$	CS setup time	5		ns
$t_{h(CS)}$	CS hold time	20		
$t_{su(SI)}$	SDI input setup time	5		
$t_{h(SI)}$	SDI input hold time	15		
$t_{v(SO)}$	SDO valid output time		50	
$t_{h(SO)}$	SDO output hold time	5		
$t_{dis(SO)}$	SDO output disable time		50	

1. Values are guaranteed at 10 MHz clock frequency for SPI with both 4 and 3 wires, based on characterization results, not tested in production.

Figure 6. SPI slave timing diagram (in mode 3)

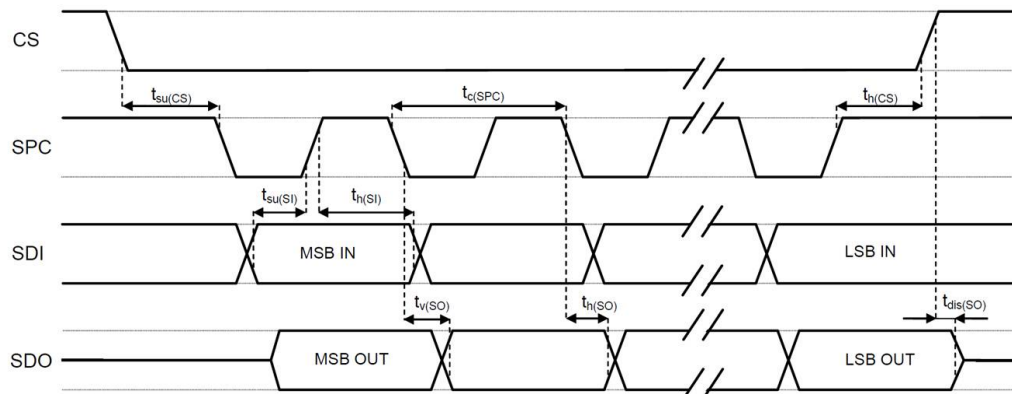

Note: Measurement points are done at $0.2 \cdot V_{dd_IO}$ and $0.8 \cdot V_{dd_IO}$ for both input and output ports.

4.4.2 I²C - inter-IC control interface

Subject to general operating conditions for V_{dd} and Top.

Table 6. I²C slave timing values

Symbol	Parameter	I ² C standard mode ⁽¹⁾		I ² C fast mode ⁽¹⁾		Unit
		Min	Max	Min	Max	
f _(SCL)	SCL clock frequency	0	100	0	400	kHz
t _{w(SCLL)}	SCL clock low time	4.7		1.3		μs
t _{w(SCLH)}	SCL clock high time	4.0		0.6		
t _{su(SDA)}	SDA setup time	250		100		ns
t _{h(SDA)}	SDA data hold time	0	3.45	0	0.9	μs
t _{h(ST)}	START condition hold time	4		0.6		
t _{su(SR)}	Repeated START condition setup time	4.7		0.6		
t _{su(SP)}	STOP condition setup time	4		0.6		
t _{w(SP:SR)}	Bus free time between STOP and START condition	4.7		1.3		

1. Data based on standard I²C protocol requirement, not tested in production.

Figure 7. I²C slave timing diagram

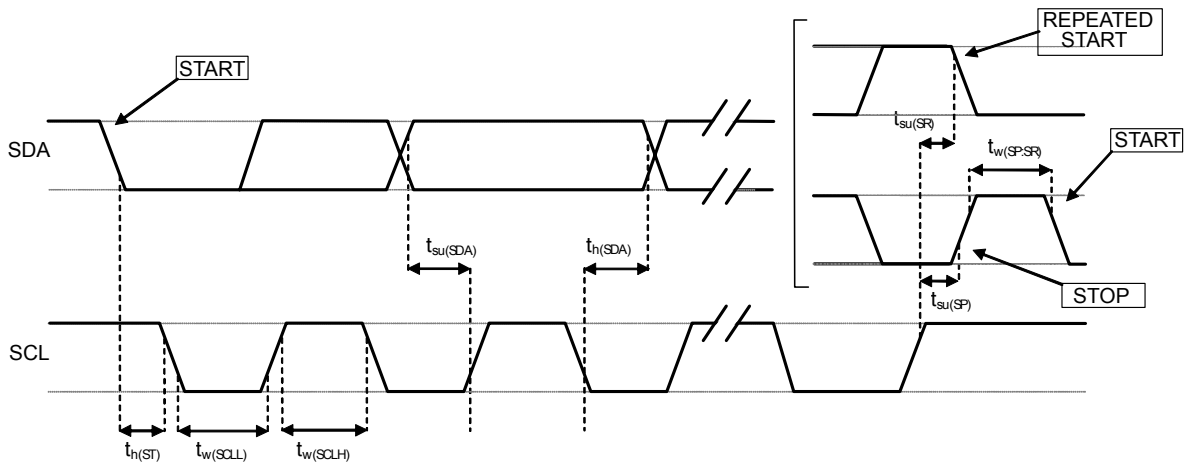

Note: Measurement points are done at 0.2·V_{dd_IO} and 0.8·V_{dd_IO} for both ports.

4.5 Absolute maximum ratings

Stresses above those listed as “Absolute maximum ratings” may cause permanent damage to the device. This is a stress rating only and functional operation of the device under these conditions is not implied. Exposure to maximum rating conditions for extended periods may affect device reliability.

Table 7. Absolute maximum ratings

Symbol	Ratings	Maximum value	Unit
Vdd and Vdd_IO	Supply voltage	-0.3 to 4.8	V
T _{STG}	Storage temperature range	-40 to +125	°C
Sg	Acceleration <i>g</i> for 0.1 ms	10000	<i>g</i>
ESD	Electrostatic discharge protection (HBM)	2	kV
V _{in}	Input voltage on any control pin (including CS, SPC, SDI, SDO)	0.3 to Vdd_IO +0.3	V

Note: *Note: Supply voltage on any pin should never exceed 4.8 V.*



This device is sensitive to mechanical shock, improper handling can cause permanent damage to the part.



This device is sensitive to electrostatic discharge (ESD), improper handling can cause permanent damage to the part.

5 Digital interfaces

5.1 I²C/SPI interface

The registers embedded inside the IIS2ICLX may be accessed through both the I²C and SPI serial interfaces. The latter may be SW configured to operate either in 3-wire or 4-wire interface mode. The device is compatible with SPI modes 0 and 3.

The serial interfaces are mapped onto the same pins. To select/exploit the I²C interface, the CS line must be tied high (i.e connected to Vdd_IO).

Table 8. Serial interface pin description

Pin name	Pin description
CS	SPI enable I ² C/SPI mode selection (1: SPI idle mode / I ² C communication enabled; 0: SPI communication mode / I ² C disabled)
SCL/SPC	I ² C Serial Clock (SCL) SPI Serial Port Clock (SPC)
SDA/SDI/SDO	I ² C Serial Data (SDA) SPI Serial Data Input (SDI) 3-wire Interface Serial Data Output (SDO)
SDO/SA0	SPI Serial Data Output (SDO) I ² C less significant bit of the device address

5.2 I²C serial interface

The IIS2ICLX I²C is a bus slave. The I²C is employed to write the data to the registers, whose content can also be read back.

The relevant I²C terminology is provided in the table below.

Table 9. I²C terminology

Term	Description
Transmitter	The device which sends data to the bus
Receiver	The device which receives data from the bus
Master	The device which initiates a transfer, generates clock signals and terminates a transfer
Slave	The device addressed by the master

There are two signals associated with the I²C bus: the serial clock line (SCL) and the Serial DATA line (SDA). The latter is a bidirectional line used for sending and receiving the data to/from the interface. Both the lines must be connected to Vdd_IO through external pull-up resistors. When the bus is free, both the lines are high.

The I²C interface is implemented with fast mode (400 kHz) I²C standards as well as with the standard mode.

In order to disable the I²C block, (I2C_disable) = 1 must be written in CTRL4_C (13h).

5.2.1 I²C operation

The transaction on the bus is started through a START (ST) signal. A START condition is defined as a HIGH to LOW transition on the data line while the SCL line is held HIGH. After this has been transmitted by the master, the bus is considered busy. The next byte of data transmitted after the start condition contains the address of the slave in the first 7 bits and the eighth bit tells whether the master is receiving data from the slave or transmitting data to the slave. When an address is sent, each device in the system compares the first seven bits after a start condition with its address. If they match, the device considers itself addressed by the master.

The Slave ADDRESS (SAD) associated to the IIS2ICLX is 110101xb. The SDO/SA0 pin can be used to modify the less significant bit of the device address. If the SDO/SA0 pin is connected to the supply voltage, LSb is '1' (address 1101011b); else if the SDO/SA0 pin is connected to ground, the LSb value is '0' (address 1101010b). This solution permits to connect and address two different inertial modules to the same I²C bus.

Data transfer with acknowledge is mandatory. The transmitter must release the SDA line during the acknowledge pulse. The receiver must then pull the data line LOW so that it remains stable low during the HIGH period of the acknowledge clock pulse. A receiver which has been addressed is obliged to generate an acknowledge after each byte of data received.

The I²C embedded inside the IIS2ICLX behaves like a slave device and the following protocol must be adhered to. After the start condition (ST) a slave address is sent, once a slave acknowledge (SAK) has been returned, an 8-bit sub-address (SUB) is transmitted. The increment of the address is configured by CTRL3_C (12h) (IF_INC).

The slave address is completed with a Read/Write bit. If the bit is '1' (Read), a repeated START (SR) condition must be issued after the two sub-address bytes; if the bit is '0' (Write) the master will transmit to the slave with direction unchanged. Table 10 explains how the SAD+Read/Write bit pattern is composed, listing all the possible configurations.

Table 10. SAD+Read/Write patterns

Command	SAD[6:1]	SAD[0] = SA0	R/W	SAD+R/W
Read	110101	0	1	11010101 (D5h)
Write	110101	0	0	11010100 (D4h)
Read	110101	1	1	11010111 (D7h)
Write	110101	1	0	11010110 (D6h)

Table 11. Transfer when master is writing one byte to slave

Master	ST	SAD + W		SUB		DATA			SP
Slave			SAK		SAK		SAK		

Table 12. Transfer when master is writing multiple bytes to slave

Master	ST	SAD + W		SUB		DATA		DATA		SP
Slave			SAK		SAK		SAK		SAK	

Table 13. Transfer when master is receiving (reading) one byte of data from slave

Master	ST	SAD + W		SUB		SR	SAD + R			NMAK	SP
Slave			SAK		SAK			SAK	DATA		

Table 14. Transfer when master is receiving (reading) multiple bytes of data from slave

Master	ST	SAD+W		SUB		SR	SAD+R			MAK		MAK		NMAK	SP
Slave			SAK		SAK			SAK	DATA		DATA		DATA		

Data are transmitted in byte format (DATA). Each data transfer contains 8 bits. The number of bytes transferred per transfer is unlimited. Data is transferred with the Most Significant bit (MSb) first. If a slave receiver doesn't acknowledge the slave address (i.e. it is not able to receive because it is performing some real-time function) the data line must be left HIGH by the slave. The master can then abort the transfer. A LOW to HIGH transition on the SDA line while the SCL line is HIGH is defined as a STOP condition. Each data transfer must be terminated by the generation of a STOP (SP) condition.

In the presented communication format MAK is Master acknowledge and NMAK is No Master Acknowledge.

5.3 SPI bus interface

The IIS2ICLX SPI is a bus slave. The SPI allows writing to and reading from the registers of the device. The serial interface communicates to the application using 4 wires: **CS**, **SPC**, **SDI** and **SDO**.

Figure 8. Read and write protocol (in mode 3)

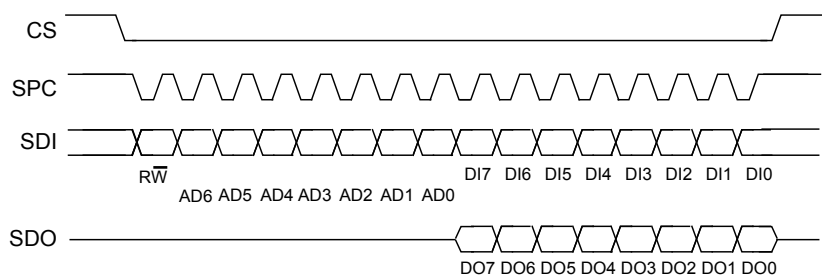

CS is the serial port enable and it is controlled by the SPI master. It goes low at the start of the transmission and goes back high at the end. **SPC** is the serial port clock and it is controlled by the SPI master. It is stopped high when **CS** is high (no transmission). **SDI** and **SDO** are, respectively, the serial port data input and output. Those lines are driven at the falling edge of **SPC** and should be captured at the rising edge of **SPC**.

Both the read register and write register commands are completed in 16 clock pulses or in multiples of 8 in case of multiple read/write bytes. Bit duration is the time between two falling edges of **SPC**. The first bit (bit 0) starts at the first falling edge of **SPC** after the falling edge of **CS** while the last bit (bit 15, bit 23, ...) starts at the last falling edge of **SPC** just before the rising edge of **CS**.

bit 0: \overline{RW} bit. When 0, the data $DI(7:0)$ is written into the device. When 1, the data $DO(7:0)$ from the device is read. In latter case, the chip will drive **SDO** at the start of bit 8.

bit 1-7: address $AD(6:0)$. This is the address field of the indexed register.

bit 8-15: data $DI(7:0)$ (write mode). This is the data that is written into the device (MSb first).

bit 8-15: data $DO(7:0)$ (read mode). This is the data that is read from the device (MSb first).

In multiple read/write commands further blocks of 8 clock periods will be added. When the [CTRL3_C \(12h\)](#) (IF_INC) bit is '0', the address used to read/write data remains the same for every block. When the [CTRL3_C \(12h\)](#) (IF_INC) bit is '1', the address used to read/write data is increased at every block.

The function and the behavior of **SDI** and **SDO** remain unchanged.

5.3.1 SPI read

Figure 9. SPI read protocol (in mode 3)

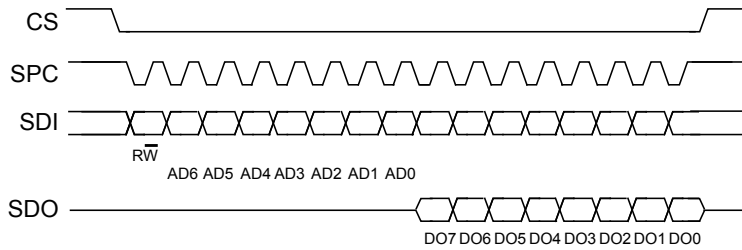

The SPI Read command is performed with 16 clock pulses. A multiple byte read command is performed by adding blocks of 8 clock pulses to the previous one.

bit 0: READ bit. The value is 1.

bit 1-7: address AD(6:0). This is the address field of the indexed register.

bit 8-15: data DO(7:0) (read mode). This is the data that will be read from the device (MSb first).

bit 16-...: data DO(...-8). Further data in multiple byte reads.

Figure 10. Multiple byte SPI read protocol (2-byte example) (in mode 3)

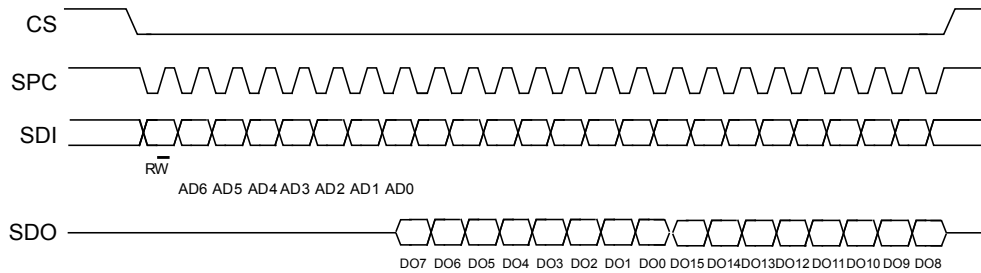

5.3.2 SPI write

Figure 11. SPI write protocol (in mode 3)

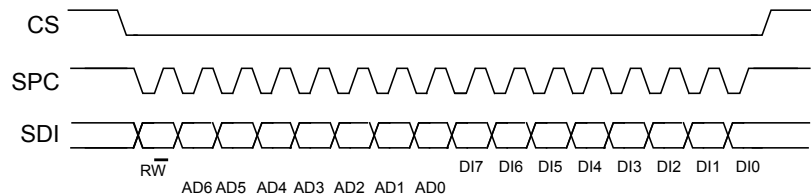

The SPI Write command is performed with 16 clock pulses. A multiple byte write command is performed by adding blocks of 8 clock pulses to the previous one.

bit 0: WRITE bit. The value is 0.

bit 1-7: address AD(6:0). This is the address field of the indexed register.

bit 8-15: data DI(7:0) (write mode). This is the data that is written inside the device (MSb first).

bit 16-... : data DI(...-8). Further data in multiple byte writes.

Figure 12. Multiple byte SPI write protocol (2-byte example) (in mode 3)

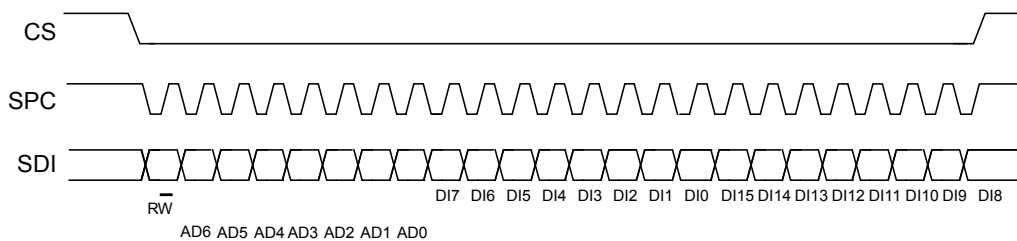

5.3.3 SPI read in 3-wire mode

A 3-wire mode is entered by setting the CTRL3_C (12h) (SIM) bit equal to '1' (SPI serial interface mode selection).

Figure 13. SPI read protocol in 3-wire mode (in mode 3)

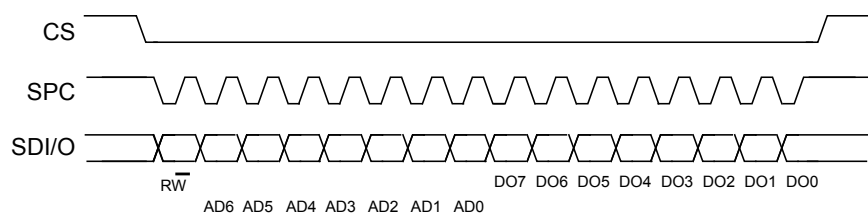

The SPI read command is performed with 16 clock pulses:

bit 0: READ bit. The value is 1.

bit 1-7: address AD(6:0). This is the address field of the indexed register.

bit 8-15: data DO(7:0) (read mode). This is the data that is read from the device (MSb first).

A multiple read command is also available in 3-wire mode.

5.4 Master I²C interface

If the IIS2ICLX is configured in Mode 2, a master I²C line is available. The master serial interface is mapped to the following dedicated pins.

Table 15. Master I²C pin details

Pin name	Pin description
MSCL	I ² C serial clock master
MSDA	I ² C serial data master
MDRDY	I ² C master external synchronization signal

6 Functionality

6.1 Block diagram of filters

Figure 14. Block diagram of filters

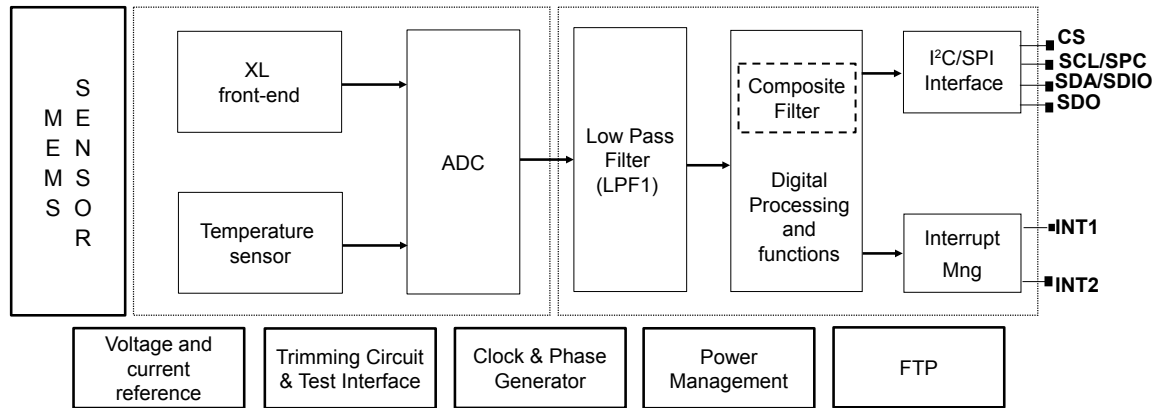

6.1.1 Block diagrams of the accelerometer filters

In the IIS2ICLX, the filtering chain for the accelerometer part is composed of the following:

- Digital filter (LPF1)
- Composite filter

Details of the block diagram appear in the following figure.

Figure 15. Accelerometer UI chain

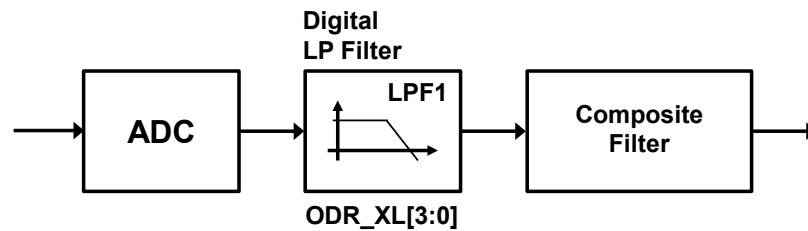
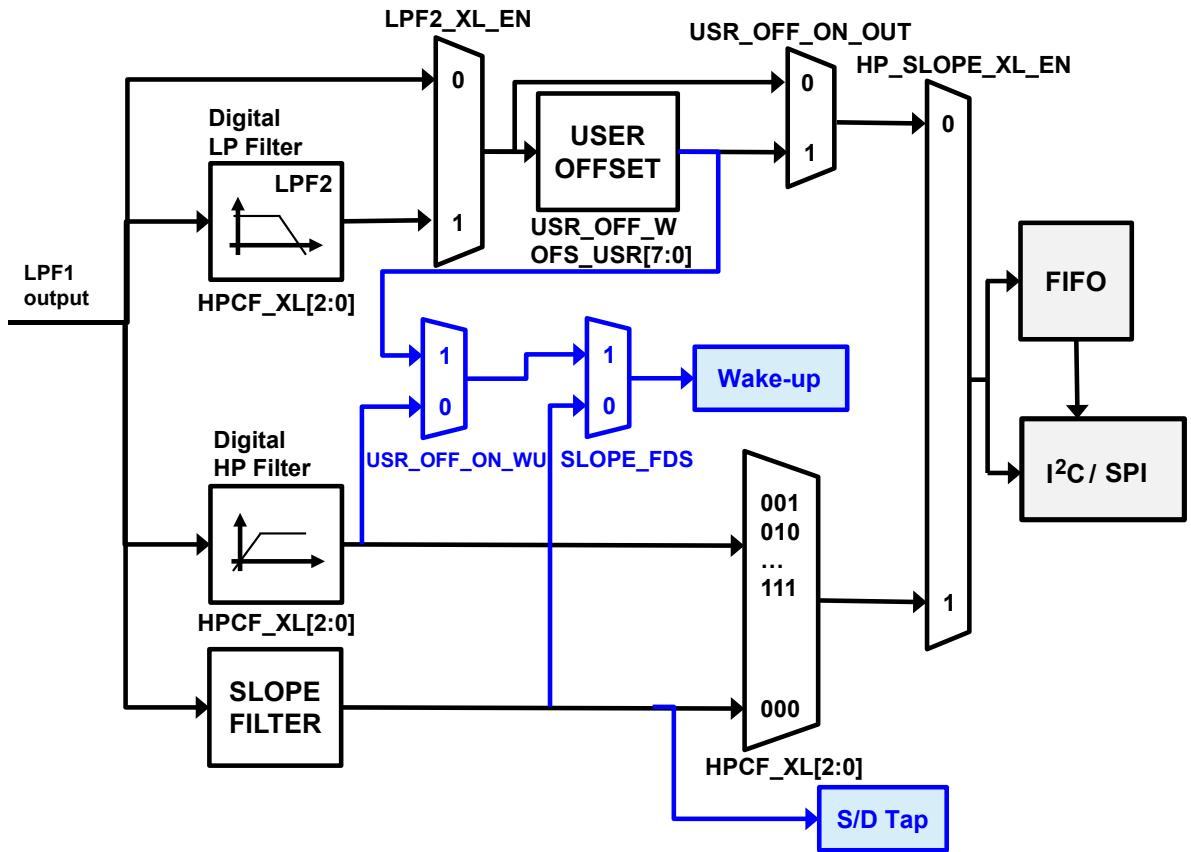

Figure 16. Accelerometer composite filter



6.2 FIFO

The presence of a FIFO buffer allows consistent power saving for the system since the host processor does not need to continuously poll data from the sensor, but it can wake up only when needed and burst the significant data out from the FIFO.

The IIS2ICLX embeds 3 kbytes of data in FIFO to store the following data:

- Accelerometer
- External sensors (up to 4)
- Timestamp
- Temperature

The applications have maximum flexibility in choosing the rate of batching for physical sensors with FIFO-dedicated configurations: accelerometer and temperature sensor batch rates can be selected by the user. Writing external sensor data in FIFO can be triggered by the accelerometer data-ready signal or by an external sensor interrupt. It is possible to select decimation for timestamp batching in FIFO with a factor of 1, 8, or 32.

The reconstruction of a FIFO stream is a simple task thanks to the FIFO_DATA_OUT_TAG byte that allows recognizing the meaning of a word in FIFO.

FIFO allows correct reconstruction of the timestamp information for each sensor stored in FIFO. If a change in the ODR or BDR (Batch Data Rate) configuration is performed, the application can correctly reconstruct the timestamp and know exactly when the change was applied without disabling FIFO batching. FIFO stores information of the new configuration and timestamp in which the change was applied in the device.

The programmable FIFO watermark threshold can be set in FIFO_CTRL1 (07h) and FIFO_CTRL2 (08h) using the WTM[8:0] bits. To monitor the FIFO status, dedicated registers (FIFO_STATUS1 (3Ah), FIFO_STATUS2 (3Bh)) can be read to detect FIFO overrun events, FIFO full status, FIFO empty status, FIFO watermark status and the number of unread samples stored in the FIFO. To generate dedicated interrupts on the INT1 and INT2 pins of these status events, the configuration can be set in INT1_CTRL (0Dh) and INT2_CTRL (0Eh).

The FIFO buffer can be configured according to six different modes:

- Bypass mode
- FIFO mode
- Continuous mode
- Continuous-to-FIFO mode
- Bypass-to-continuous mode
- Bypass-to-FIFO mode

Each mode is selected by the FIFO_MODE_[2:0] bits in the FIFO_CTRL4 (0Ah) register.

6.2.1 Bypass mode

In Bypass mode (FIFO_CTRL4 (0Ah)(FIFO_MODE_[2:0] = 000), the FIFO is not operational and it remains empty. Bypass mode is also used to reset the FIFO when in FIFO mode.

6.2.2 FIFO mode

In FIFO mode (FIFO_CTRL4 (0Ah)(FIFO_MODE_[2:0] = 001) data from the output channels are stored in the FIFO until it is full.

To reset FIFO content, Bypass mode should be selected by writing FIFO_CTRL4 (0Ah)(FIFO_MODE_[2:0]) to '000'. After this reset command, it is possible to restart FIFO mode by writing FIFO_CTRL4 (0Ah) (FIFO_MODE_[2:0]) to '001'.

The FIFO buffer memorizes up to 3 kbytes of data but the depth of the FIFO can be resized by setting the WTM [8:0] bits in FIFO_CTRL1 (07h) and FIFO_CTRL2 (08h). If the STOP_ON_WTM bit in FIFO_CTRL2 (08h) is set to '1', FIFO depth is limited up to the WTM [8:0] bits in FIFO_CTRL1 (07h) and FIFO_CTRL2 (08h).

6.2.3 Continuous mode

Continuous mode (**FIFO_CTRL4 (0Ah)**(**FIFO_MODE_[2:0]** = 110) provides a continuous FIFO update: as new data arrives, the older data is discarded.

A FIFO threshold flag **FIFO_STATUS2 (3Bh)**(**FIFO_WTM_IA**) is asserted when the number of unread samples in FIFO is greater than or equal to **FIFO_CTRL1 (07h)** and **FIFO_CTRL2 (08h)** (**WTM [8:0]**).

It is possible to route the **FIFO_WTM_IA** flag to the INT1 pin by writing in register **INT1_CTRL (0Dh)** (**INT1_FIFO_TH**) = '1' or to the INT2 pin by writing in register **INT2_CTRL (0Eh)**(**INT2_FIFO_TH**) = '1'.

A full-flag interrupt can be enabled, **INT1_CTRL (0Dh)**(**INT1_FIFO_FULL**) = '1' or **INT2_CTRL (0Eh)** (**INT2_FIFO_FULL**) = '1', in order to indicate FIFO saturation and eventually read its content all at once.

If an overrun occurs, at least one of the oldest samples in FIFO has been overwritten and the **FIFO_OVR_IA** flag in **FIFO_STATUS2 (3Bh)** is asserted.

In order to empty the FIFO before it is full, it is also possible to pull from FIFO the number of unread samples available in **FIFO_STATUS1 (3Ah)** and **FIFO_STATUS2 (3Bh)**(**DIFF_FIFO_[9:0]**).

6.2.4 Continuous-to-FIFO mode

In Continuous-to-FIFO mode (**FIFO_CTRL4 (0Ah)**(**FIFO_MODE_[2:0]** = 011), FIFO behavior changes according to the trigger event detected in one of the following interrupt events:

- Single tap
- Double tap
- Wake-up

When the selected trigger bit is equal to '1', FIFO operates in FIFO mode.

When the selected trigger bit is equal to '0', FIFO operates in Continuous mode.

6.2.5 Bypass-to-Continuous mode

In Bypass-to-Continuous mode (**FIFO_CTRL4 (0Ah)**(**FIFO_MODE_[2:0]** = '100'), data measurement storage inside FIFO operates in Continuous mode when selected triggers are equal to '1', otherwise FIFO content is reset (Bypass mode).

FIFO behavior changes according to the trigger event detected in one of the following interrupt events:

- Single tap
- Double tap
- Wake-up

6.2.6 Bypass-to-FIFO mode

In Bypass-to-FIFO mode (**FIFO_CTRL4 (0Ah)**(**FIFO_MODE_[2:0]** = '111'), data measurement storage inside FIFO operates in FIFO mode when selected triggers are equal to '1', otherwise FIFO content is reset (Bypass mode).

FIFO behavior changes according to the trigger event detected in one of the following interrupt events:

- Single tap
- Double tap
- Wake-up

6.2.7 FIFO reading procedure

The data stored in FIFO are accessible from dedicated registers and each FIFO word is composed of 7 bytes: one tag byte (**FIFO_DATA_OUT_TAG (78h)**), in order to identify the sensor, and 6 bytes of fixed data (**FIFO_DATA_OUT** registers from (79h) to (7Eh)).

The **DIFF_FIFO_[9:0]** field in the **FIFO_STATUS1 (3Ah)** and **FIFO_STATUS2 (3Bh)** registers contains the number of words (1 byte TAG + 6 bytes DATA) collected in FIFO.

In addition, it is possible to configure a counter of the batch events of the accelerometer sensor. The flag **COUNTER_BDR_IA** in **FIFO_STATUS2 (3Bh)** alerts that the counter reaches a selectable threshold (**CNT_BDR_TH_[10:0]** field in **COUNTER_BDR_REG1 (0Bh)** and **COUNTER_BDR_REG2 (0Ch)**). This allows triggering the reading of FIFO with the desired latency of one single sensor. As for the other FIFO status events, the flag **COUNTER_BDR_IA** can be routed on the INT1 or INT2 pins by asserting the corresponding bits (**INT1_CNT_BDR** of **INT1_CTRL (0Dh)** and **INT2_CNT_BDR** of **INT2_CTRL (0Eh)**).

Meta information about the accelerometer sensor configuration changes can be managed by enabling the **ODR_CHG_EN** bit in **FIFO_CTRL2 (08h)**.

7 Frequency response

The IIS2ICLX filtering chain and frequency response are detailed in the following figures.

Figure 17. Filtering chain

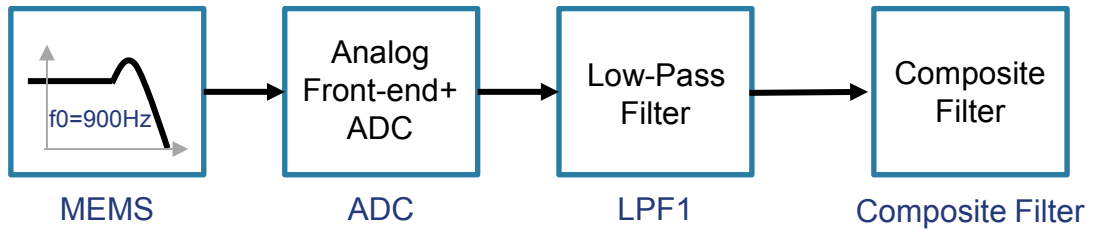

The output of the ADC converter is filtered with a digital low-pass filter to ensure the intended sensor's frequency response.

The frequency response at the output of the LPF1 filter is indicated in the following figure.

Figure 18. Frequency response at the output of LPF1 filter at different ODR configurations

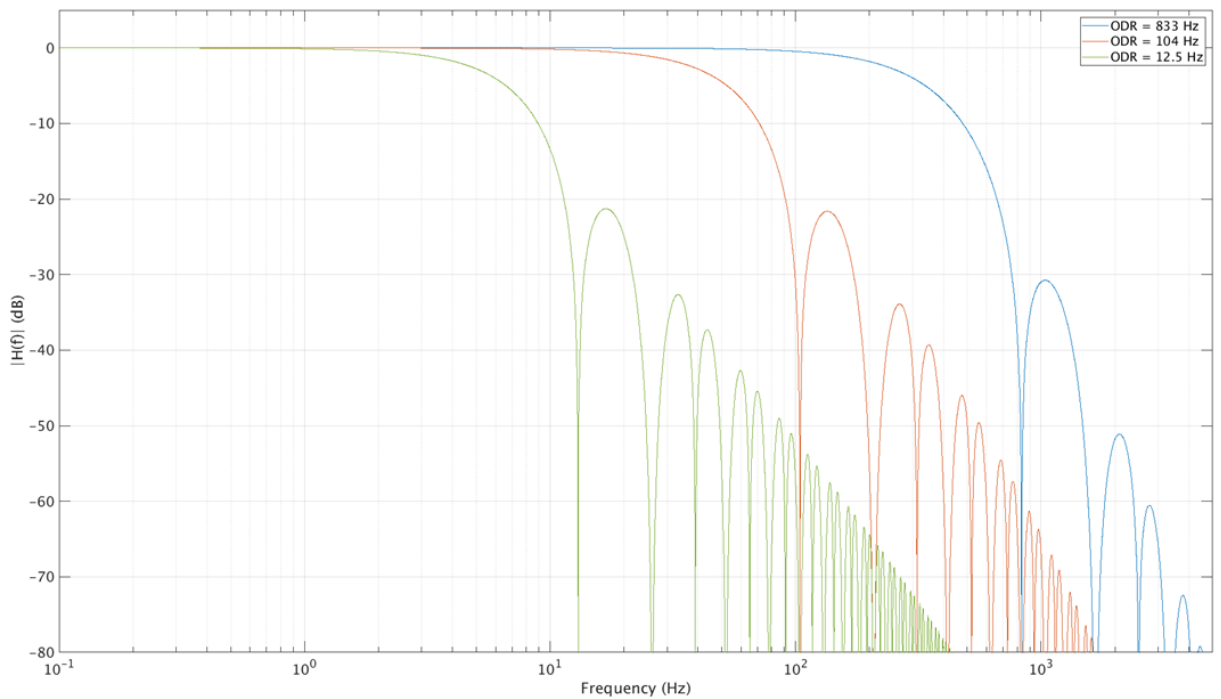

The frequency response is determined by CAD simulation.

8 Typical performance characteristics

8.1 Frequency response measurements

The frequency response of the IIS2ICLX, measured on a mechanical shaker, is indicated in the following figures. Measurements have been performed with the IIS2ICLX configured with the digital composite filter bypassed.

Figure 19. Frequency response- X-axis ODR = 833 Hz, BW = ODR/2

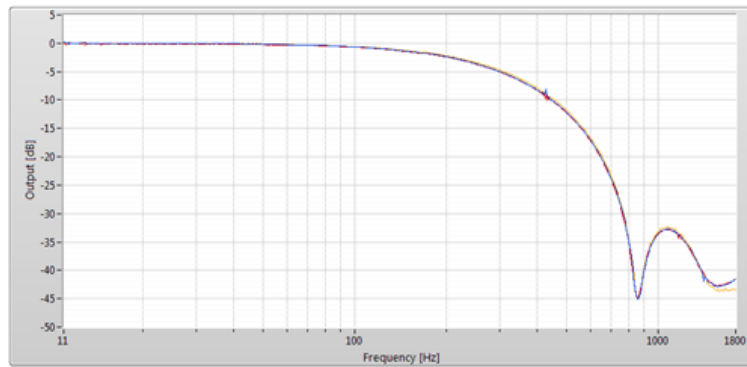

Figure 20. Frequency response - Y-axis ODR = 833 Hz, BW = ODR/2

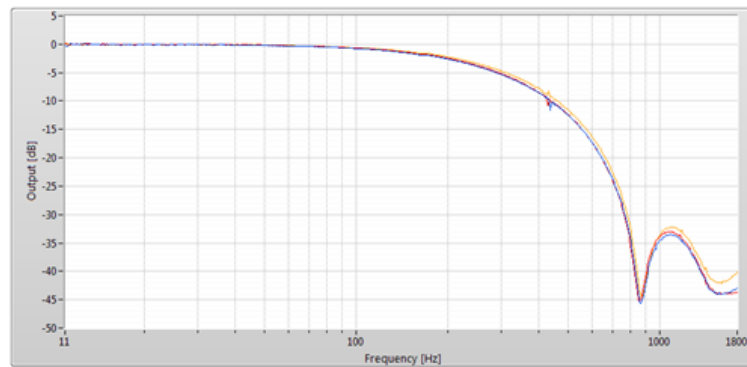

Figure 21. Frequency response - X-axis ODR = 104 Hz, BW = ODR/2

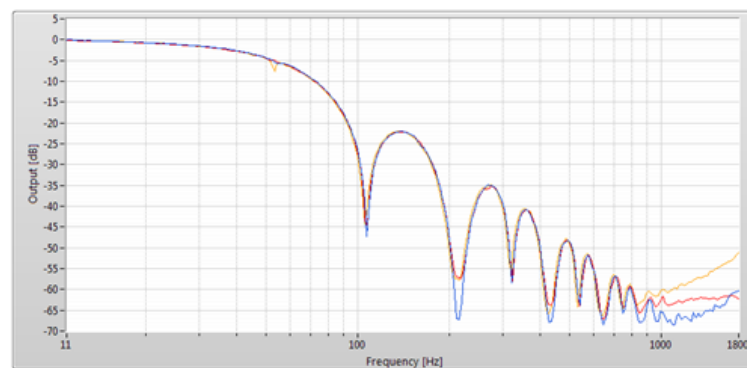
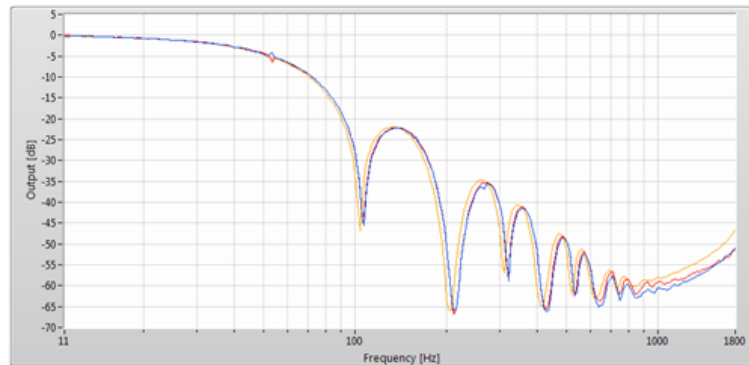
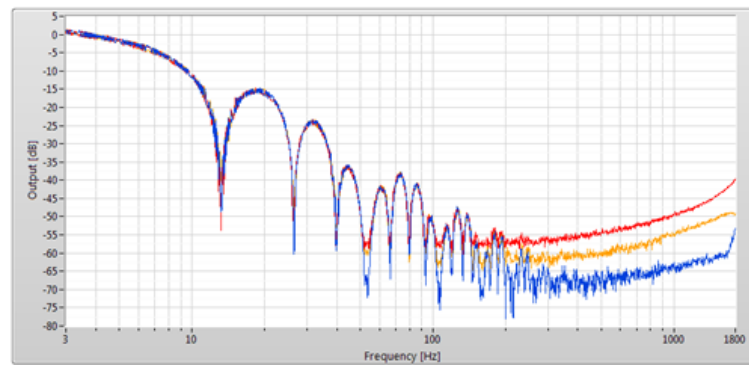
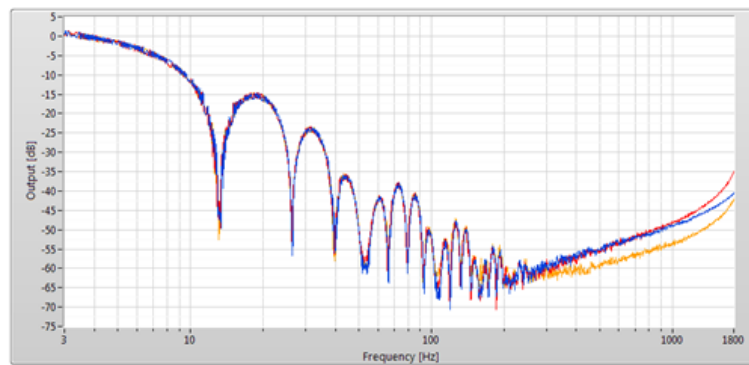

Figure 22. Frequency response - Y-axis ODR = 104 Hz, BW = ODR/2

Figure 23. Frequency response - X-axis ODR = 12.5 Hz, BW = ODR/2

Figure 24. Frequency response - Y-axis ODR = 12.5 Hz, BW = ODR/2

Note: Characterization data on a few parts. Not measured in production and not guaranteed.

9 Application hints

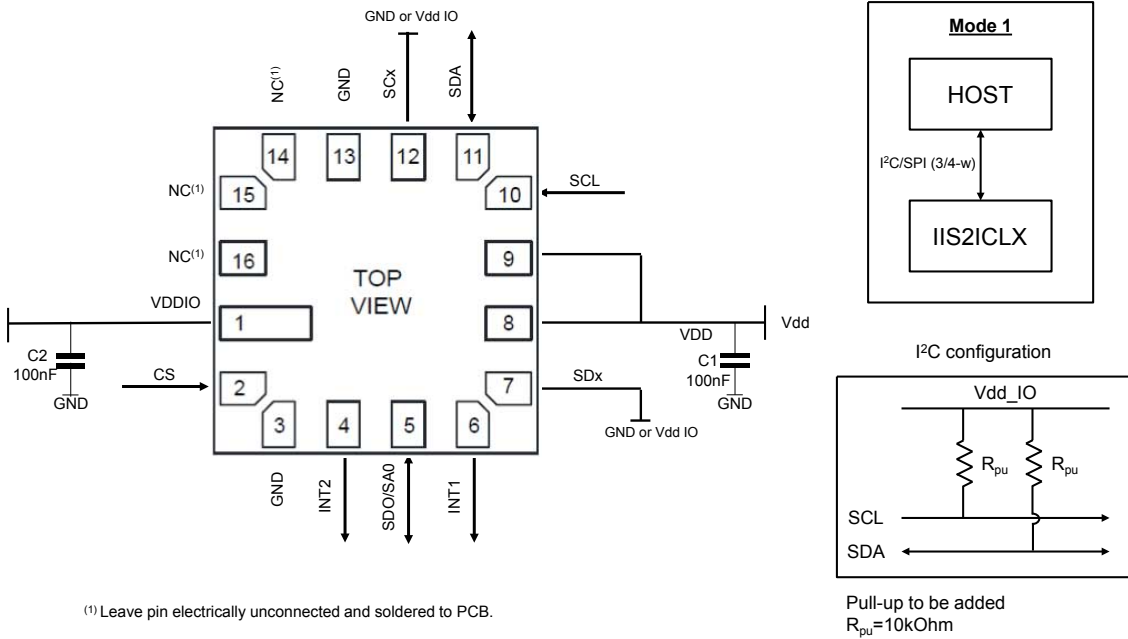
9.1 IIS2ICLX electrical connections in Mode 1

Figure 25. IIS2ICLX electrical connections in Mode 1



The device core is supplied through the Vdd line. Power supply decoupling capacitors (C1, C2 = 100 nF ceramic) should be placed as near as possible to the supply pin of the device (common design practice).

The functionality of the device and the measured acceleration data are selectable and accessible through the I²C/SPI interface.

The functions, the threshold and the timing of the two interrupt pins for each sensor can be completely programmed by the user through the I²C/SPI interface.

9.2 IIS2ICLX electrical connections in Mode 2

Figure 26. IIS2ICLX electrical connections in Mode 2

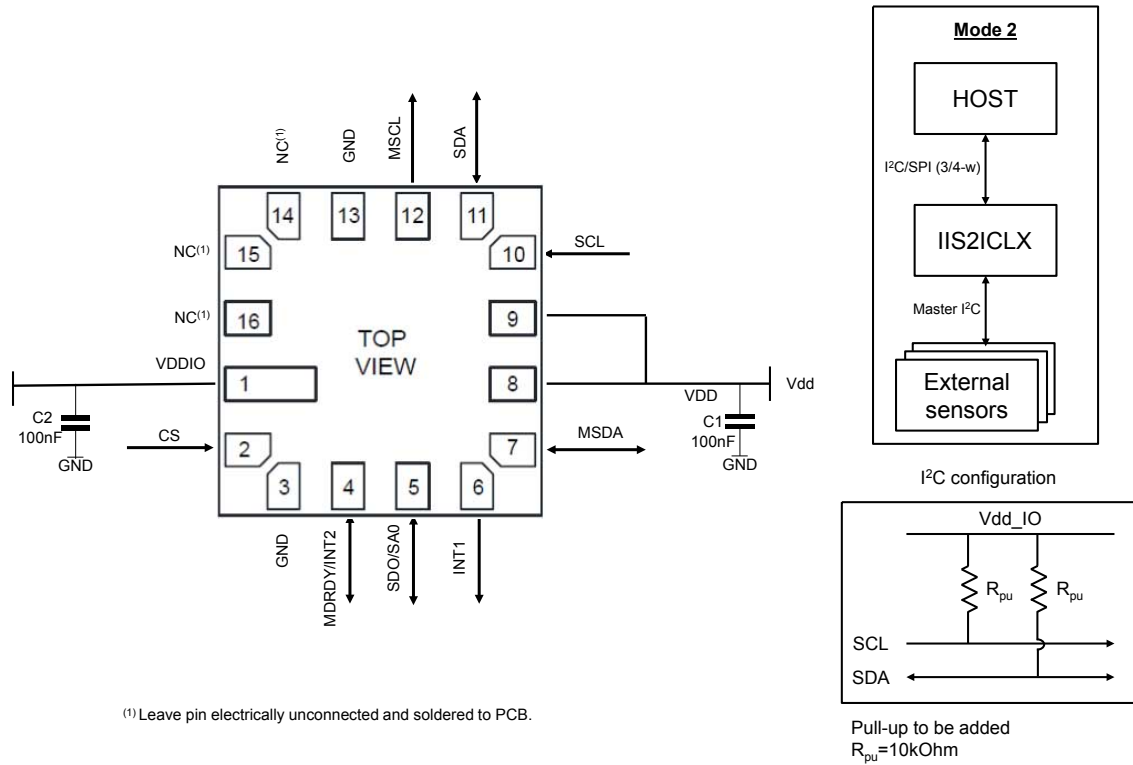

The device core is supplied through the Vdd line. Power supply decoupling capacitors (C1, C2 = 100 nF ceramic) should be placed as near as possible to the supply pin of the device (common design practice).

The functionality of the device and the measured acceleration data are selectable and accessible through the I²C/SPI primary interface.

The functions, the threshold and the timing of the two interrupt pins for each sensor can be completely programmed by the user through the I²C/SPI primary interface.

The procedure to correctly initialize the device is as follows:

1. INT1: Leave unconnected or connect with external pull-down during power-on. Pull-up must be avoided on this pin.
2. INT2: Recommend to not connect with external pull-up.
3. Properly configure the device:
 - a. SPI interface: I2C_disable = 1 in CTRL4_C (13h) and DEVICE_CONF = 1 in CTRL9_XL (18h).
 - b. I²C interface: I2C_disable = 0 (default) in CTRL4_C (13h) and DEVICE_CONF = 1 in CTRL9_XL (18h).

Table 16. Internal pin status

Pin #	Name	Mode 1 function	Mode 2 function	Pin status Mode 1	Pin status Mode 2
1	VDD_IO	Power supply for I/O pins (recommended 100 nF filter capacitor)			
2	CS	I ² C/SPI mode selection (1:SPI idle mode / I ² C communication enabled; 0: SPI communication mode / I ² C disabled)		Default: input with pull-up. Pull-up is disabled if bit I2C_disable = 1 in reg 13h and DEVICE_CONF = 1 in reg 18h.	Default: input with pull-up. Pull-up is disabled if bit I2C_disable = 1 in reg 13h and DEVICE_CONF = 1 in reg 18h.
3	GND	0 V supply			
4	INT2	Programmable interrupt 2 (INT2) / Data enable (DEN)	Programmable interrupt 2 (INT2)/ Data enable (DEN)/ I ² C master external synchronization signal (MDRDY)	Default: output forced to ground	Default: output forced to ground
5	SDO	SPI 4-wire interface serial data output (SDO)		Default: input without pull-up. Pull-up is enabled if bit SDO_PU_EN = 1 in reg 02h.	Default: input without pull-up. Pull-up is enabled if bit SDO_PU_EN = 1 in reg 02h.
	SA0	I ² C least significant bit of the device address (SA0)			
6	INT1	Programmable Interrupt 1 (INT1)		Default: input with pull-down ⁽¹⁾	Default: input with pull-down ⁽¹⁾
7	SDx	Connect to GND or VDD_IO	I ² C serial data master (MSDA)	Default: input without pull-up. Pull-up is enabled if bit SHUB_PU_EN = 1 in reg 14h in sensor hub registers.	Default: input without pull-up. Pull-up is enabled if bit SHUB_PU_EN = 1 in reg 14h in sensor hub registers.
8	VDD	Power supply (recommended 100 nF filter capacitor)			
9	VDD	Power supply (recommended 100 nF filter capacitor)			
10	SCL	I ² C serial clock (SCL) / SPI serial port clock (SPC)		Default: input without pull-up	Default: input without pull-up
11	SDA/SDI	I ² C serial data (SDA)		Default: input without pull-up	Default: input without pull-up
		SPI serial data input (SDI) 3-wire interface serial data output (SDO)			
12	SCx	Connect to GND or VDD_IO	I ² C serial clock master (MSCL)	Default: input without pull-up. Pull-up is enabled if bit SHUB_PU_EN = 1 in reg 14h in sensor hub registers.	Default: input without pull-up. Pull-up is enabled if bit SHUB_PU_EN = 1 in reg 14h in sensor hub registers.
13	GND	GND			
14	NC	Connect to GND or leave unconnected			
15	NC	Connect to GND or leave unconnected			
16	NC	Connect to GND or leave unconnected			

1. INT1 must be set to '0' or left unconnected during power-on.

10 Register map

The table given below provides a list of the 8/16-bit registers embedded in the device and the corresponding addresses.

Table 17. Registers address map

Name	Type	Register address		Default	Comment
		Hex	Binary		
FUNC_CFG_ACCESS	RW	01	00000001	00000000	
PIN_CTRL	RW	02	00000010	00111111	
RESERVED	-	03-06			Reserved
FIFO_CTRL1	RW	07	00000111	00000000	
FIFO_CTRL2	RW	08	00001000	00000000	
FIFO_CTRL3	RW	09	00001001	00000000	
FIFO_CTRL4	RW	0A	00001010	00000000	
COUNTER_BDR_REG1	RW	0B	00001011	00000000	
COUNTER_BDR_REG2	RW	0C	00001100	00000000	
INT1_CTRL	RW	0D	00001101	00000000	
INT2_CTRL	RW	0E	00001110	00000000	
WHO_AM_I	R	0F	00001111	01101011	
CTRL1_XL	RW	10	00010000	00000000	
RESERVED	-	11	00010001		Reserved
CTRL3_C	RW	12	00010010	00000100	
CTRL4_C	RW	13	00010011	00000000	
CTRL5_C	RW	14	00010100	00000000	
CTRL6_C	RW	15	00010101	00000000	
CTRL7_XL	RW	16	00010110	00000000	
CTRL8_XL	RW	17	00010111	00000000	
CTRL9_XL	RW	18	00011000	11100000	
CTRL10_C	RW	19	00011001	00000000	
ALL_INT_SRC	R	1A	00011010	output	
WAKE_UP_SRC	R	1B	00011011	output	
TAP_SRC	R	1C	00011100	output	
DEN_SRC	R	1D	00011101	output	
STATUS_REG	R	1E	00011110	output	
RESERVED	-	1F	00011111		Reserved
OUT_TEMP_L	R	20	00100000	output	
OUT_TEMP_H	R	21	00100001	output	
RESERVED	-	22-27	00100010		Reserved
OUTX_L_A	R	28	00101000	output	
OUTX_H_A	R	29	00101001	output	

Name	Type	Register address		Default	Comment
		Hex	Binary		
OUTY_L_A	R	2A	00101010	output	
OUTY_H_A	R	2B	00101011	output	
RESERVED	-	2C-34			Reserved
EMB_FUNC_STATUS_MAINPAGE	R	35	00110101	output	
FSM_STATUS_A_MAINPAGE	R	36	00110110	output	
FSM_STATUS_B_MAINPAGE	R	37	00110111	output	
MLC_STATUS_MAINPAGE	R	38	00111000	output	
STATUS_MASTER_MAINPAGE	R	39	00111001	output	
FIFO_STATUS1	R	3A	00111010	output	
FIFO_STATUS2	R	3B	00111011	output	
RESERVED	-	3C-3F			Reserved
TIMESTAMP0	R	40	01000000	output	
TIMESTAMP1	R	41	01000001	output	
TIMESTAMP2	R	42	01000010	output	
TIMESTAMP3	R	43	01000011	output	
RESERVED	-	44-55			Reserved
TAP_CFG0	RW	56	01010110	00000000	
TAP_CFG1	RW	57	01010111		Reserved
TAP_CFG2	RW	58	01011000	00000000	
RESERVED	-	59	01011001		Reserved
INT_DUR2	RW	5A	01011010	00000000	
WAKE_UP_THS	RW	5B	01011011	00000000	
WAKE_UP_DUR	RW	5C	01011100	00000000	
RESERVED	-	5D	01011101		Reserved
MD1_CFG	RW	5E	01011110	00000000	
MD2_CFG	RW	5F	01011111	00000000	
RESERVED	-	60-62			Reserved
INTERNAL_FREQ_FINE	R	63	01100011	output	
RESERVED	-	64-72			Reserved
X_OFS_USR	RW	73	01110011	00000000	
Y_OFS_USR	RW	74	01110100	00000000	
RESERVED	-	75-77			Reserved
FIFO_DATA_OUT_TAG	R	78	01111000	output	
FIFO_DATA_OUT_X_L	R	79	01111001	output	
FIFO_DATA_OUT_X_H	R	7A	01111010	output	
FIFO_DATA_OUT_Y_L	R	7B	01111011	output	
FIFO_DATA_OUT_Y_H	R	7C	01111100	output	
FIFO_DATA_OUT_Z_L	R	7D	01111101	output	
FIFO_DATA_OUT_Z_H	R	7E	01111110	output	

11 Register description

The device contains a set of registers which are used to control its behavior and to retrieve linear acceleration and temperature data. The register addresses, made up of 7 bits, are used to identify them and to write the data through the serial interface.

11.1 FUNC_CFG_ACCESS (01h)

Enable embedded functions register (r/w)

Table 18. FUNC_CFG_ACCESS register

FUNC_CFG_ACCESS	SHUB_REG_ACCESS	0 ⁽¹⁾	0 ⁽¹⁾	0 ⁽¹⁾	0 ⁽¹⁾	0 ⁽¹⁾	0 ⁽¹⁾
-----------------	-----------------	------------------	------------------	------------------	------------------	------------------	------------------

1. This bit must be set to '0' for the correct operation of the device.

Table 19. FUNC_CFG_ACCESS register description

FUNC_CFG_ACCESS	Enable access to the embedded functions configuration registers. Default value: 0 ⁽¹⁾
SHUB_REG_ACCESS	Enable access to the sensor hub (I ² C master) registers. Default value: 0 ⁽²⁾

1. Details concerning the embedded functions configuration registers are available in [Section 12 Embedded functions register map](#) and [Section 13 Embedded functions register description](#).
2. Details concerning the sensor hub registers are available in [Section 16 Sensor hub register map](#) and [Section 17 Sensor hub register description](#).

11.2 PIN_CTRL (02h)

SDO pin pull-up enable/disable register (r/w)

Table 20. PIN_CTRL register

0 ⁽¹⁾	SDO_PU_EN	1 ⁽²⁾	1 ⁽²⁾	1 ⁽²⁾	1 ⁽²⁾	1 ⁽²⁾	1 ⁽²⁾
------------------	-----------	------------------	------------------	------------------	------------------	------------------	------------------

1. This bit must be set to '0' for the correct operation of the device.
2. This bit must be set to '1' for the correct operation of the device.

Table 21. PIN_CTRL register description

SDO_PU_EN	Enable pull-up on SDO pin. Default value: 0 (0: SDO pin pull-up disconnected (default); 1: SDO pin with pull-up)
-----------	---

11.3 FIFO_CTRL1 (07h)

FIFO control register 1 (r/w)

Table 22. FIFO_CTRL1 register

WTM7	WTM6	WTM5	WTM4	WTM3	WTM2	WTM1	WTM0
------	------	------	------	------	------	------	------

Table 23. FIFO_CTRL1 register description

WTM[7:0]	<p>FIFO watermark threshold, in conjunction with WTM8 in FIFO_CTRL2 (08h)</p> <p>1 LSB = 1 sensor (6 bytes) + TAG (1 byte) written in FIFO</p> <p>Watermark flag rises when the number of bytes written in the FIFO is greater than or equal to the threshold level.</p>
----------	--

11.4 FIFO_CTRL2 (08h)

FIFO control register 2 (r/w)

Table 24. FIFO_CTRL2 register

STOP_ON_WTM	0 ⁽¹⁾	0	ODRCHG_EN	0 ⁽¹⁾	0 ⁽¹⁾	0 ⁽¹⁾	WTM8
-------------	------------------	---	-----------	------------------	------------------	------------------	------

1. This bit must be set to '0' for the correct operation of the device.

Table 25. FIFO_CTRL2 register

STOP_ON_WTM	<p>Sensing chain FIFO stop values memorization at threshold level</p> <p>(0: FIFO depth is not limited (default);</p> <p>1: FIFO depth is limited to the threshold level, defined in FIFO_CTRL1 (07h) and FIFO_CTRL2 (08h)</p>
ODRCHG_EN	Enables ODR CHANGE virtual sensor to be batched in FIFO
WTM8	<p>FIFO watermark threshold, in conjunction with WTM[7:0] in FIFO_CTRL1 (07h)</p> <p>1 LSB = 1 sensor (6 bytes) + TAG (1 byte) written in FIFO</p> <p>Watermark flag rises when the number of bytes written in FIFO is greater than or equal to the threshold level.</p>

11.5 FIFO_CTRL3 (09h)

FIFO control register 3 (r/w)

Table 26. FIFO_CTRL3 register

0 ⁽¹⁾	0 ⁽¹⁾	0 ⁽¹⁾	0 ⁽¹⁾	BDR_XL_3	BDR_XL_2	BDR_XL_1	BDR_XL_0
------------------	------------------	------------------	------------------	----------	----------	----------	----------

1. This bit must be set to '0' for the correct operation of the device.

Table 27. FIFO_CTRL3 register description

BDR_XL_[3:0]	<p>Selects Batch Data Rate (write frequency in FIFO) for accelerometer data. (0000: Accelerometer not batched in FIFO (default); 0001: 12.5 Hz; 0010: 26 Hz; 0011: 52 Hz; 0100: 104 Hz; 0101: 208 Hz; 0110: 417 Hz; 0111: 833 Hz; 1000: not allowed; 1001: not allowed; 1010: not allowed; 1011: 1.6 Hz; 1100-1111: not allowed)</p>
--------------	--

11.6 FIFO_CTRL4 (0Ah)

FIFO control register 4 (r/w)

Table 28. FIFO_CTRL4 register

DEC_TS_BATCH_1	DEC_TS_BATCH_0	ODR_T_BATCH_1	ODR_T_BATCH_0	0 ⁽¹⁾	FIFO_MODE2	FIFO_MODE1	FIFO_MODE0
----------------	----------------	---------------	---------------	------------------	------------	------------	------------

1. This bit must be set to '0' for the correct operation of the device.

Table 29. FIFO_CTRL4 register description

DEC_TS_BATCH_[1:0]	Selects decimation for timestamp batching in FIFO. Writing rate will be the rate of the accelerometer divided by the decimation decoder (00: Timestamp not batched in FIFO (default); 01: Decimation 1; 10: Decimation 8; 11: Decimation 32)
ODR_T_BATCH_[1:0]	Selects Batch Data Rate (write frequency in FIFO) for temperature data (00: Temperature not batched in FIFO (default); 01: 1.6 Hz; 10: 12.5 Hz; 11: 52 Hz)
FIFO_MODE[2:0]	FIFO mode selection (000: Bypass mode: FIFO disabled; 001: FIFO mode: stops collecting data when FIFO is full; 010: Reserved; 011: Continuous-to-FIFO mode: Continuous mode until trigger is deasserted, then FIFO mode; 100: Bypass-to-Continuous mode: Bypass mode until trigger is deasserted, then Continuous mode; 101: Reserved; 110: Continuous mode: if the FIFO is full, the new sample overwrites the older one; 111: Bypass-to-FIFO mode: Bypass mode until trigger is deasserted, then FIFO mode.)

11.7 COUNTER_BDR_REG1 (0Bh)

Counter batch data rate register 1 (r/w)

Table 30. COUNTER_BDR_REG1 register

dataready_pulsed	RST_COUNTER_BDR	0 ⁽¹⁾	0 ⁽¹⁾	0 ⁽¹⁾	0 ⁽¹⁾	0 ⁽¹⁾	CNT_BDR_TH_8
------------------	-----------------	------------------	------------------	------------------	------------------	------------------	--------------

1. This bit must be set to '0' for the correct operation of the device.

Table 31. COUNTER_BDR_REG1 register description

dataready_pulsed	Enables pulsed data-ready mode (0: Data-ready latched mode (returns to 0 only after an interface reading) (default); 1: Data-ready pulsed mode (the data ready pulses are 75 µs long)
RST_COUNTER_BDR	Resets the internal counter of batch events for a single sensor. This bit is automatically reset to zero if it was set to '1'.
CNT_BDR_TH_8	In conjunction with CNT_BDR_TH_[7:0] in COUNTER_BDR_REG2 (0Ch), sets the threshold for the internal counter of batch events. When this counter reaches the threshold, the counter is reset and the COUNTER_BDR_IA flag in FIFO_STATUS2 (3Bh) is set to '1'.

11.8 COUNTER_BDR_REG2 (0Ch)

Counter batch data rate register 2 (r/w)

CNT_BDR_TH_7	CNT_BDR_TH_6	CNT_BDR_TH_5	CNT_BDR_TH_4	CNT_BDR_TH_3	CNT_BDR_TH_2	CNT_BDR_TH_1	CNT_BDR_TH_0
--------------	--------------	--------------	--------------	--------------	--------------	--------------	--------------

Table 32. COUNTER_BDR_REG2 register description

CNT_BDR_TH_[7:0]	In conjunction with CNT_BDR_TH_[10:8] in COUNTER_BDR_REG1 (0Bh), sets the threshold for the internal counter of batch events. When this counter reaches the threshold, the counter is reset and the COUNTER_BDR_IA flag in FIFO_STATUS2 (3Bh) is set to '1'.
------------------	--

11.9 INT1_CTRL (0Dh)

INT1 pin control register (r/w)

Each bit in this register enables a signal to be carried over INT1. The output of the pin will be the OR combination of the signals selected here and in [MD1_CFG \(5Eh\)](#).

DEN_DRDY_flag	INT1_CNT_BDR	INT1_FIFO_FULL	INT1_FIFO_OVR	INT1_FIFO_TH	INT1_BOOT	0 ⁽¹⁾	INT1_DRDY_XL
---------------	--------------	----------------	---------------	--------------	-----------	------------------	--------------

1. This bit must be set to '0' for the correct operation of the device.

Table 33. INT1_CTRL register description

DEN_DRDY_flag	Sends DEN_DRDY (DEN stamped on Sensor Data flag) to INT1 pin.
INT1_CNT_BDR	Enables COUNTER_BDR_IA interrupt on INT1.
INT1_FIFO_FULL	Enables FIFO full flag interrupt on INT1 pin.
INT1_FIFO_OVR	Enables FIFO overrun interrupt on INT1 pin.
INT1_FIFO_TH	Enables FIFO threshold interrupt on INT1 pin.
INT1_BOOT	Enables boot status on INT1 pin.
INT1_DRDY_XL	Enables accelerometer data-ready interrupt on INT1 pin.

11.10 INT2_CTRL (0Eh)

INT2 pin control register (r/w)

Each bit in this register enables a signal to be carried over INT2. The output of the pin will be the OR combination of the signals selected here and in [MD2_CFG \(5Fh\)](#).

Table 34. INT2_CTRL register

0 ⁽¹⁾	INT2_CNT_BDR	INT2_FIFO_FULL	INT2_FIFO_OVR	INT2_FIFO_TH	INT2_DRDY_TEMP	0 ⁽¹⁾	INT2_DRDY_XL
------------------	--------------	----------------	---------------	--------------	----------------	------------------	--------------

1. This bit must be set to '0' for the correct operation of the device.

Table 35. INT2_CTRL register description

INT2_CNT_BDR	Enables COUNTER_BDR_IA interrupt on INT2 pin.
INT2_FIFO_FULL	Enables FIFO full flag interrupt on INT2 pin.
INT2_FIFO_OVR	Enables FIFO overrun interrupt on INT2 pin.
INT2_FIFO_TH	Enables FIFO threshold interrupt on INT2 pin.
INT2_DRDY_TEMP	Enables temperature sensor data-ready interrupt on INT2 pin.
INT2_DRDY_XL	Enables accelerometer data-ready interrupt on INT2 pin.

11.11 WHO_AM_I (0Fh)

WHO_AM_I register (r). This is a read-only register. Its value is fixed at 6Bh.

Table 36. Who_Am_I register

0	1	1	0	1	0	1	1
---	---	---	---	---	---	---	---

11.12 CTRL1_XL (10h)

Accelerometer control register 1 (r/w)

ODR_XL3	ODR_XL2	ODR_XL1	ODR_XL0	FS1_XL	FS0_XL	LPF2_XL_EN	0 ⁽¹⁾
---------	---------	---------	---------	--------	--------	------------	------------------

1. This bit must be set to '0' for the correct operation of the device.

Table 37. CTRL1_XL register description

ODR_XL[3:0]	Accelerometer ODR selection (see Table 38)
FS[1:0]_XL	Accelerometer full-scale selection (see Table 39)
LPF2_XL_EN	Accelerometer high-resolution selection (0: output from first stage digital filtering selected (default); 1: output from LPF2 second filtering stage selected)

Table 38. Accelerometer ODR selection

ODR_XL3	ODR_XL2	ODR_XL1	ODR_XL0	ODR selection [Hz]
0	0	0	0	Power-down
0	0	0	1	12.5 Hz
0	0	1	0	26 Hz
0	0	1	1	52 Hz
0	1	0	0	104 Hz
0	1	0	1	208 Hz
0	1	1	0	416 Hz
0	1	1	1	833 Hz
1	x	x	x	RESERVED

Table 39. Accelerometer full-scale selection

FS[1:0]_XL	XL_FS
00	±0.5 g
01	±3 g
10	±1 g
11	±2 g

11.13 CTRL3_C (12h)

Control register 3 (r/w)

Table 40. CTRL3_C register

BOOT	BDU	H_LACTIVE	PP_OD	SIM	IF_INC	0 ⁽¹⁾	SW_RESET
------	-----	-----------	-------	-----	--------	------------------	----------

1. This bit must be set to '0' for the correct operation of the device.

Table 41. CTRL3_C register description

BOOT	Reboots memory content. Default value: 0 (0: normal mode; 1: reboot memory content) This bit is automatically cleared.
BDU	Block Data Update. Default value: 0 (0: continuous update; 1: output registers are not updated until MSB and LSB have been read)
H_LACTIVE	Interrupt activation level. Default value: 0 (0: interrupt output pins active high; 1: interrupt output pins active low)
PP_OD	Push-pull/open-drain selection on INT1 and INT2 pins. This bit must be set to '0' when H_LACTIVE is set to '1'. Default value: 0 (0: push-pull mode; 1: open-drain mode)
SIM	SPI Serial Interface Mode selection. Default value: 0 (0: 4-wire interface; 1: 3-wire interface)
IF_INC	Register address automatically incremented during a multiple byte access with a serial interface (I ² C or SPI). Default value: 1 (0: disabled; 1: enabled)
SW_RESET	Software reset. Default value: 0 (0: normal mode; 1: reset device) This bit is automatically cleared.

11.14 CTRL4_C (13h)

Control register 4 (r/w)

Table 42. CTRL4_C register

0 ⁽¹⁾	0 ⁽¹⁾	INT2_on_INT1	0 ⁽¹⁾	DRDY_MASK	I2C_disable	0 ⁽¹⁾	0 ⁽¹⁾
------------------	------------------	--------------	------------------	-----------	-------------	------------------	------------------

1. This bit must be set to '0' for the correct operation of the device.

Table 43. CTRL4_C register description

INT2_on_INT1	All interrupt signals available on INT1 pin enable. Default value: 0 (0: interrupt signals divided between INT1 and INT2 pins; 1: all interrupt signals in logic or on INT1 pin)
DRDY_MASK	Enables data available (0: disabled; 1: mask DRDY on pin until filter settling ends)
I2C_disable	Disables I ² C interface. Default value: 0 (0: SPI and I ² C interfaces enabled (default); 1: I ² C interface disabled)

11.15 CTRL5_C (14h)

Control register 5 (r/w)

Table 44. CTRL5_C register

0 ⁽¹⁾	0 ⁽¹⁾	0 ⁽¹⁾	0 ⁽¹⁾	0 ⁽¹⁾	0 ⁽¹⁾	ST1_XL	ST0_XL
------------------	------------------	------------------	------------------	------------------	------------------	--------	--------

1. This bit must be set to '0' for the correct operation of the device.

Table 45. CTRL5_C register description

ST[1:0]_XL	Linear acceleration sensor self-test enable. Default value: 00 (00: Self-test disabled; Other: refer to Table 46)
------------	--

Table 46. Linear acceleration sensor self-test mode selection

ST1_XL	ST0_XL	Self-test mode
0	0	Normal mode
0	1	Positive sign self-test
1	0	Negative sign self-test
1	1	Not allowed

11.16 CTRL6_C (15h)

Control register 6 (r/w)

Table 47. CTRL6_C register

TRIG_EN	LVL1_EN	LVL2_EN	0 ⁽¹⁾	USR_OFF_W	0 ⁽¹⁾	0 ⁽¹⁾	0 ⁽¹⁾
---------	---------	---------	------------------	-----------	------------------	------------------	------------------

1. This bit must be set to '0' for the correct operation of the device.

Table 48. CTRL6_C register description

TRIG_EN	Enables DEN data edge-sensitive trigger mode. Refer to Table 49 .
LVL1_EN	Enables DEN data level-sensitive trigger mode. Refer to Table 49.
LVL2_EN	Enables DEN level-sensitive latched mode. Refer to Table 49.
USR_OFF_W	Weight of XL user offset bits of registers X_OFS_USR (73h), Y_OFS_USR (74h). (0: 2 ⁻¹⁰ g/LSB; 1: 2 ⁻⁶ g/LSB)

Table 49. Trigger mode selection

TRIG_EN, LVL1_EN, LVL2_EN	Trigger mode
100	Edge-sensitive trigger mode is selected
010	Level-sensitive trigger mode is selected
011	Level-sensitive latched mode is selected
110	Level-sensitive FIFO enable mode is selected

11.17 CTRL7_XL (16h)

Control register 7 (r/w)

Table 50. CTRL7_XL register

0 ⁽¹⁾	0 ⁽¹⁾	0 ⁽¹⁾	0 ⁽¹⁾	0 ⁽¹⁾	0 ⁽¹⁾	USR_OFF_ON_OUT	0 ⁽¹⁾
------------------	------------------	------------------	------------------	------------------	------------------	----------------	------------------

1. This bit must be set to '0' for the correct operation of the device.

Table 51. CTRL7_XL register description

USR_OFF_ON_OUT	Enables accelerometer user offset correction block; it's valid for the low-pass path - see Figure 16. Accelerometer composite filter . Default value: 0 (0: accelerometer user offset correction block bypassed; 1: accelerometer user offset correction block enabled)
----------------	---

11.18 CTRL8_XL (17h)

Control register 8 (r/w)

Table 52. CTRL8_XL register

HPCF_XL_2	HPCF_XL_1	HPCF_XL_0	HP_REF_MODE_XL	FASTSETTL_MODE_XL	HP_SLOPE_XL_EN	0 ⁽¹⁾	0 ⁽¹⁾
-----------	-----------	-----------	----------------	-------------------	----------------	------------------	------------------

1. This bit must be set to '0' for the correct operation of the device.

HPCF_XL[2:0]	Accelerometer LPF2 and HP filter configuration and cutoff setting. Refer to Table 53 .
HP_REF_MODE_XL	Enables accelerometer high-pass filter reference mode (valid for high-pass path - HP_SLOPE_XL_EN bit must be '1'). Default value: 0 ⁽¹⁾⁽²⁾ (0: disabled, 1: enabled)
FASTSETTL_MODE_XL	Enables accelerometer LPF2 and HPF fast-settling mode. The filter sets the second samples after writing this bit. Active only during device exit from power-down mode. Default value: 0 (0: disabled, 1: enabled)
HP_SLOPE_XL_EN	Accelerometer slope filter / high-pass filter selection. Refer to Figure 16. Accelerometer composite filter .

1. HPCF_XL[2:0] must be set to "111" before enabling this bit.

2. When enabled, the first output data have to be discarded.

Table 53. Accelerometer bandwidth configurations

Filter type	HP_SLOPE_XL_EN	LPF2_XL_EN	HPCF_XL[2:0]	Bandwidth
Low pass	0	0	-	ODR/2
			000	ODR/4
		1	001	ODR/10
			010	ODR/20
			011	ODR/45
			100	ODR/100
			101	ODR/200
			110	ODR/400
High pass	1	-	111	ODR/800
			000	SLOPE (ODR/4)
			001	ODR/10
			010	ODR/20
			011	ODR/45
			100	ODR/100
			101	ODR/200
			110	ODR/400
			111	ODR/800

11.19 CTRL9_XL (18h)

Control register 9 (r/w)

Table 54. CTRL9_XL register

DEN_X	DEN_Y	1 ⁽¹⁾	1 ⁽¹⁾	DEN_EN	DEN_LH	DEVICE_CONF	0 ⁽²⁾
-------	-------	------------------	------------------	--------	--------	-------------	------------------

1. This bit must be set to '1' to properly use the DEN feature.
2. This bit must be set to '0' for the correct operation of the device.

Table 55. CTRL9_XL register description

DEN_X	DEN value stored in LSB of X-axis. Default value: 1 (0: DEN not stored in X-axis LSB; 1: DEN stored in X-axis LSB)
DEN_Y	DEN value stored in LSB of Y-axis. Default value: 1 (0: DEN not stored in Y-axis LSB; 1: DEN stored in Y-axis LSB)
DEN_EN	Enable DEN functionality. Default value: 0 (0: disabled; 1: enabled)
DEN_LH	DEN active level configuration. Default value: 0 (0: active low; 1: active high)
DEVICE_CONF	Enables the proper device configuration. Default value: 0 (0: default; 1: enabled) It is recommended to set this bit to 1 at initialization phase (and after any software reset) and always keep it to 1 afterwards.

11.20 CTRL10_C (19h)

Control register 10 (r/w)

Table 56. CTRL10_C register

0 ⁽¹⁾	0 ⁽¹⁾	TIMESTAMP_EN	0 ⁽¹⁾	0 ⁽¹⁾	0 ⁽¹⁾	0 ⁽¹⁾	0 ⁽¹⁾
------------------	------------------	--------------	------------------	------------------	------------------	------------------	------------------

1. This bit must be set to '0' for the correct operation of the device.

Table 57. CTRL10_C register description

TIMESTAMP_EN	Enables timestamp counter. Default value: 0 (0: disabled; 1: enabled) The counter is readable in TIMESTAMP0 (40h), TIMESTAMP1 (41h), TIMESTAMP2 (42h), and TIMESTAMP3 (43h).
--------------	--

11.21 ALL_INT_SRC (1Ah)

Source register for all interrupts (r)

Table 58. ALL_INT_SRC register

TIMESTAMP_ENDCOUNT	0	SLEEP_CHANGE	0	DOUBLE_TAP	SINGLE_TAP	WU_IA	0
--------------------	---	--------------	---	------------	------------	-------	---

Table 59. ALL_INT_SRC register description

TIMESTAMP_ENDCOUNT	Alerts timestamp overflow within 6.4 ms
SLEEP_CHANGE	Detects change event in stationary/motion status. Default value: 0 (0: change status not detected; 1: change status detected)
DOUBLE_TAP	Double-tap event status. Default value: 0 (0: event not detected, 1: event detected)
SINGLE_TAP	Single-tap event status. Default value: 0 (0: event not detected, 1: event detected)
WU_IA	Wake-up event status. Default value: 0 (0: event not detected, 1: event detected)

11.22 WAKE_UP_SRC (1Bh)

Wake-up interrupt source register (r)

Table 60. WAKE_UP_SRC register

0	SLEEP_CHANGE_IA	0	SLEEP_STATE	WU_IA	X_WU	Y_WU	0
---	-----------------	---	-------------	-------	------	------	---

Table 61. WAKE_UP_SRC register description

SLEEP_CHANGE_IA	Detects change event in stationary/motion status. Default value: 0 (0: change status not detected; 1: change status detected)
SLEEP_STATE	Sleep status bit. Default value: 0 (0: sleep event not detected; 1: sleep event detected)
WU_IA	Wakeup event detection status. Default value: 0 (0: wakeup event not detected; 1: wakeup event detected.)
X_WU	Wakeup event detection status on X-axis. Default value: 0 (0: wakeup event on X-axis not detected; 1: wakeup event on X-axis detected)
Y_WU	Wakeup event detection status on Y-axis. Default value: 0 (0: wakeup event on Y-axis not detected; 1: wakeup event on Y-axis detected)

11.23 TAP_SRC (1Ch)

Tap source register (r)

Table 62. TAP_SRC register

0	TAP_IA	SINGLE_TAP	DOUBLE_TAP	TAP_SIGN	X_TAP	Y_TAP	0
---	--------	------------	------------	----------	-------	-------	---

Table 63. TAP_SRC register description

TAP_IA	Tap event detection status. Default: 0 (0: tap event not detected; 1: tap event detected)
SINGLE_TAP	Single-tap event status. Default value: 0 (0: single tap event not detected; 1: single tap event detected)
DOUBLE_TAP	Double-tap event detection status. Default value: 0 (0: double-tap event not detected; 1: double-tap event detected)
TAP_SIGN	Sign of acceleration detected by tap event. Default: 0 (0: positive sign of acceleration detected by tap event; 1: negative sign of acceleration detected by tap event)
X_TAP	Tap event detection status on X-axis. Default value: 0 (0: tap event on X-axis not detected; 1: tap event on X-axis detected)
Y_TAP	Tap event detection status on Y-axis. Default value: 0 (0: tap event on Y-axis not detected; 1: tap event on Y-axis detected)

11.24 DEN_SRC (1Dh)

DEN data-ready register (r)

Table 64. DEN_SRC register

DEN_DRDY	0	0	0	0	0	0	0
----------	---	---	---	---	---	---	---

Table 65. DEN_SRC register description

DEN_DRDY	DEN data-ready signal. It is set high when data output is related to the data coming from a DEN active condition. ⁽¹⁾
----------	--

1. The DEN data-ready signal can be latched or pulsed depending on the value of the dataready pulsed bit of the COUNTER_BDR_REG1 (0Bh) register.

11.25 STATUS_REG (1Eh)

Status register (r)

Table 66. STATUS_REG register

0	0	0	0	0	TDA	0	XLDA
---	---	---	---	---	-----	---	------

Table 67. STATUS_REG register description

TDA	Temperature new data available. Default: 0 (0: no set of data is available at temperature sensor output; 1: a new set of data is available at temperature sensor output)
XLDA	Accelerometer new data available. Default value: 0 (0: no set of data available at accelerometer output; 1: a new set of data is available at accelerometer output)

11.26 OUT_TEMP_L (20h), OUT_TEMP_H (21h)

Temperature data output register (r). L and H registers together express a 16-bit word in two's complement.

Table 68. OUT_TEMP_L register

Temp7	Temp6	Temp5	Temp4	Temp3	Temp2	Temp1	Temp0
-------	-------	-------	-------	-------	-------	-------	-------

Table 69. OUT_TEMP_H register

Temp15	Temp14	Temp13	Temp12	Temp11	Temp10	Temp9	Temp8
--------	--------	--------	--------	--------	--------	-------	-------

Table 70. OUT_TEMP register description

Temp[15:0]	Temperature sensor output data. The value is expressed as two's complement.
------------	---

11.27 OUTX_L_A (28h) and OUTX_H_A (29h)

Linear acceleration sensor X-axis output register (r). The value is expressed as a 16-bit word in two's complement.

Table 71. OUTX_L_A register

D7	D6	D5	D4	D3	D2	D1	D0
----	----	----	----	----	----	----	----

Table 72. OUTX_H_A register

D15	D14	D13	D12	D11	D10	D9	D8
-----	-----	-----	-----	-----	-----	----	----

Table 73. OUTX_H_A register description

D[15:0]	X-axis linear acceleration value. D[15:0] expressed in two's complement.
---------	--

11.28 OUTY_L_A (2Ah) and OUTY_H_A (2Bh)

Linear acceleration sensor Y-axis output register (r). The value is expressed as a 16-bit word in two's complement.

Table 74. OUTY_L_A register

D7	D6	D5	D4	D3	D2	D1	D0
----	----	----	----	----	----	----	----

Table 75. OUTY_H_A register

D15	D14	D13	D12	D11	D10	D9	D8
-----	-----	-----	-----	-----	-----	----	----

Table 76. OUTY_H_A register description

D[15:0]	Y-axis linear acceleration value. D[15:0] expressed in two's complement.
---------	--

11.29 EMB_FUNC_STATUS_MAINPAGE (35h)

Embedded function status register (r)

Table 77. EMB_FUNC_STATUS_MAINPAGE register

IS_FSM_LC	0	0	0	0	0	0	0
-----------	---	---	---	---	---	---	---

Table 78. EMB_FUNC_STATUS_MAINPAGE register description

IS_FSM_LC	Interrupt status bit for FSM long counter timeout interrupt event. (1: interrupt detected; 0: no interrupt)
-----------	--

11.30 FSM_STATUS_A_MAINPAGE (36h)

Finite State Machine status register (r)

Table 79. FSM_STATUS_A_MAINPAGE register

IS_FSM8	IS_FSM7	IS_FSM6	IS_FSM5	IS_FSM4	IS_FSM3	IS_FSM2	IS_FSM1
---------	---------	---------	---------	---------	---------	---------	---------

Table 80. FSM_STATUS_A_MAINPAGE register description

IS_FSM8	Interrupt status bit for FSM8 interrupt event. (1: interrupt detected; 0: no interrupt)
IS_FSM7	Interrupt status bit for FSM7 interrupt event. (1: interrupt detected; 0: no interrupt)
IS_FSM6	Interrupt status bit for FSM6 interrupt event. (1: interrupt detected; 0: no interrupt)
IS_FSM5	Interrupt status bit for FSM5 interrupt event. (1: interrupt detected; 0: no interrupt)
IS_FSM4	Interrupt status bit for FSM4 interrupt event. (1: interrupt detected; 0: no interrupt)
IS_FSM3	Interrupt status bit for FSM3 interrupt event. (1: interrupt detected; 0: no interrupt)
IS_FSM2	Interrupt status bit for FSM2 interrupt event. (1: interrupt detected; 0: no interrupt)
IS_FSM1	Interrupt status bit for FSM1 interrupt event. (1: interrupt detected; 0: no interrupt)

11.31 FSM_STATUS_B_MAINPAGE (37h)

Finite State Machine status register (r)

Table 81. FSM_STATUS_B_MAINPAGE register

IS_FSM16	IS_FSM15	IS_FSM14	IS_FSM13	IS_FSM12	IS_FSM11	IS_FSM10	IS_FSM9
----------	----------	----------	----------	----------	----------	----------	---------

Table 82. FSM_STATUS_B_MAINPAGE register description

IS_FSM16	Interrupt status bit for FSM16 interrupt event. (1: interrupt detected; 0: no interrupt)
IS_FSM15	Interrupt status bit for FSM15 interrupt event. (1: interrupt detected; 0: no interrupt)
IS_FSM14	Interrupt status bit for FSM14 interrupt event. (1: interrupt detected; 0: no interrupt)
IS_FSM13	Interrupt status bit for FSM13 interrupt event. (1: interrupt detected; 0: no interrupt)
IS_FSM12	Interrupt status bit for FSM12 interrupt event. (1: interrupt detected; 0: no interrupt)
IS_FSM11	Interrupt status bit for FSM11 interrupt event. (1: interrupt detected; 0: no interrupt)
IS_FSM10	Interrupt status bit for FSM10 interrupt event. (1: interrupt detected; 0: no interrupt)
IS_FSM9	Interrupt status bit for FSM9 interrupt event. (1: interrupt detected; 0: no interrupt)

11.32 MLC_STATUS_MAINPAGE (38h)

Machine Learning Core status register (r)

Table 83. MLC_STATUS_MAINPAGE register

IS_MLC8	IS_MLC7	IS_MLC6	IS_MLC5	IS_MLC4	IS_MLC3	IS_MLC2	IS_MLC1
---------	---------	---------	---------	---------	---------	---------	---------

Table 84. MLC_STATUS_MAINPAGE register description

IS_MLC8	Interrupt status bit for MLC8 interrupt event. (1: interrupt detected; 0: no interrupt)
IS_MLC7	Interrupt status bit for MLC7 interrupt event. (1: interrupt detected; 0: no interrupt)
IS_MLC6	Interrupt status bit for MLC6 interrupt event. (1: interrupt detected; 0: no interrupt)
IS_MLC5	Interrupt status bit for MLC5 interrupt event. (1: interrupt detected; 0: no interrupt)
IS_MLC4	Interrupt status bit for MLC4 interrupt event. (1: interrupt detected; 0: no interrupt)
IS_MLC3	Interrupt status bit for MLC3 interrupt event. (1: interrupt detected; 0: no interrupt)
IS_MLC2	Interrupt status bit for MLC2 interrupt event. (1: interrupt detected; 0: no interrupt)
IS_MLC1	Interrupt status bit for MLC1 interrupt event. (1: interrupt detected; 0: no interrupt)

11.33 STATUS_MASTER_MAINPAGE (39h)

Sensor hub source register (r)

Table 85. STATUS_MASTER_MAINPAGE register

WR_ONCE_DONE	SLAVE3_NACK	SLAVE2_NACK	SLAVE1_NACK	SLAVE0_NACK	0	0	SENS_HUB_ENDOP
--------------	-------------	-------------	-------------	-------------	---	---	----------------

Table 86. STATUS_MASTER_MAINPAGE register description

WR_ONCE_DONE	When the bit WRITE_ONCE in MASTER_CONFIG (14h) is configured as 1, this bit is set to 1 when the write operation on slave 0 has been performed and completed. Default value: 0
SLAVE3_NACK	This bit is set to 1 if Not acknowledge occurs on slave 3 communication. Default value: 0
SLAVE2_NACK	This bit is set to 1 if Not acknowledge occurs on slave 2 communication. Default value: 0
SLAVE1_NACK	This bit is set to 1 if Not acknowledge occurs on slave 1 communication. Default value: 0
SLAVE0_NACK	This bit is set to 1 if Not acknowledge occurs on slave 0 communication. Default value: 0
SENS_HUB_ENDOP	Sensor hub communication status. Default value: 0 (0: sensor hub communication not concluded; 1: sensor hub communication concluded)

11.34 FIFO_STATUS1 (3Ah)

FIFO status register 1 (r)

Table 87. FIFO_STATUS1 register

DIFF_FIFO_7	DIFF_FIFO_6	DIFF_FIFO_5	DIFF_FIFO_4	DIFF_FIFO_3	DIFF_FIFO_2	DIFF_FIFO_1	DIFF_FIFO_0
-------------	-------------	-------------	-------------	-------------	-------------	-------------	-------------

Table 88. FIFO_STATUS1 register description

DIFF_FIFO_[7:0]	Number of unread sensor data (TAG + 6 bytes) stored in FIFO In conjunction with DIFF_FIFO[9:8] in FIFO_STATUS2 (3Bh).
-----------------	--

11.35 FIFO_STATUS2 (3Bh)

FIFO status register 2 (r)

Table 89. FIFO_STATUS2 register

FIFO_WTM_IA	FIFO_OVR_IA	FIFO_FULL_IA	COUNTER_BDR_IA	FIFO_OVR_LATCHED	0	DIFF_FIFO_9	DIFF_FIFO_8
-------------	-------------	--------------	----------------	------------------	---	-------------	-------------

Table 90. FIFO_STATUS2 register description

FIFO_WTM_IA	FIFO watermark status. Default value: 0 (0: FIFO filling is lower than WTM; 1: FIFO filling is equal to or greater than WTM) Watermark is set through bits WTM[8:0] in FIFO_CTRL2 (08h) and FIFO_CTRL1 (07h).
FIFO_OVR_IA	FIFO overrun status. Default value: 0 (0: FIFO is not completely filled; 1: FIFO is completely filled)
FIFO_FULL_IA	Smart FIFO full status. Default value: 0 (0: FIFO is not full; 1: FIFO will be full at the next ODR)
COUNTER_BDR_IA	Counter BDR reaches the CNT_BDR_TH_[10:0] threshold set in COUNTER_BDR_REG1 (0Bh) and COUNTER_BDR_REG2 (0Ch). Default value: 0 This bit is reset when these registers are read.
FIFO_OVR_LATCHED	Latched FIFO overrun status. Default value: 0 This bit is reset when this register is read.
DIFF_FIFO_[9:8]	Number of unread sensor data (TAG + 6 bytes) stored in FIFO. Default value: 00 In conjunction with DIFF_FIFO[7:0] in FIFO_STATUS1 (3Ah)

11.36 **TIMESTAMP0 (40h), TIMESTAMP1 (41h), TIMESTAMP2 (42h), and TIMESTAMP3 (43h)**

Timestamp first data output register (r). The value is expressed as a 32-bit word and the bit resolution is 25 μ s.

Table 91. TIMESTAMP output registers

D31	D30	D29	D28	D27	D26	D25	D24
D23	D22	D21	D20	D19	D18	D17	D16
D15	D14	D13	D12	D11	D10	D9	D8
D7	D6	D5	D4	D3	D2	D1	D0

Table 92. TIMESTAMP output register description

D[31:0]	Timestamp output registers: 1LSB = 25 μ s
---------	---

The formula below can be used to calculate a better estimation of the actual timestamp resolution:

$$TS_Res = 1 / (40000 + (0.0015 * INTERNAL_FREQ_FINE * 40000))$$

where INTERNAL_FREQ_FINE is the content of INTERNAL_FREQ_FINE (63h).

11.37 TAP_CFG0 (56h)

Configuration of filtering and tap recognition functions (r/w)

Table 93. TAP_CFG0 register

0	INT_CLR_ON_READ	SLEEP_STATUS_ON_INT	SLOPE_FDS	TAP_X_EN	TAP_Y_EN	0	LIR
---	-----------------	---------------------	-----------	----------	----------	---	-----

Table 94. TAP_CFG0 register description

INT_CLR_ON_READ	This bit allows immediately clearing the latched interrupts of an event detection upon the read of the corresponding status register. It must be set to 1 together with LIR. Default value: 0 (0: latched interrupt signal cleared at the end of the ODR period; 1: latched interrupt signal immediately cleared)
SLEEP_STATUS_ON_INT	Motion/stationary interrupt mode configuration. If INT1_SLEEP_CHANGE or INT2_SLEEP_CHANGE bits are enabled, drives the sleep status or sleep change on the INT pins. Default value: 0 (0: sleep change notification on INT pins; 1: sleep status reported on INT pins)
SLOPE_FDS	HPF or SLOPE filter selection on wake-up function. Default value: 0 (0: SLOPE filter applied; 1: HPF applied)
TAP_X_EN	Enable X direction in tap recognition. Default value: 0 (0: X direction disabled; 1: X direction enabled)
TAP_Y_EN	Enable Y direction in tap recognition. Default value: 0 (0: Y direction disabled; 1: Y direction enabled)
LIR	Latched Interrupt. Default value: 0 (0: interrupt request not latched; 1: interrupt request latched)

11.38 TAP_CFG1 (57h)

Tap configuration register (r/w)

Table 95. TAP_CFG1 register

0	0	TAP_PRIORITY	TAP_THS_X_4	TAP_THS_X_3	TAP_THS_X_2	TAP_THS_X_1	TAP_THS_X_0
---	---	--------------	-------------	-------------	-------------	-------------	-------------

Table 96. TAP_CFG1 register description

TAP_PRIORITY	(0: X max, Y min; 1: Y max, X min)
TAP_THS_X[4:0]	X-axis tap recognition threshold. Default value: 0 1 LSB = $FS_{XL} / (2^5)$ <i>Note: If selecting $FS_{XL} = \pm 3 g$, 1 LSB = $4 / 2^5 g$.</i>

11.39 TAP_CFG2 (58h)

Enables interrupt and tap recognition functions (r/w)

Table 97. TAP_CFG2 register

INTERRUPTS_ENABLE	0	0	TAP_THS_Y_4	TAP_THS_Y_3	TAP_THS_Y_2	TAP_THS_Y_1	TAP_THS_Y_0
-------------------	---	---	-------------	-------------	-------------	-------------	-------------

Table 98. TAP_CFG2 register description

INTERRUPTS_ENABLE	Enable basic interrupts (wake-up, tap). Default value: 0 (0: interrupt disabled; 1: interrupt enabled)
TAP_THS_Y[4:0]	Y-axis tap recognition threshold. Default value: 0 1 LSB = $FS_{XL} / (2^5)$ <i>Note: If selecting $FS_{XL} = \pm 3 g$, 1 LSB = $4 / 2^5 g$.</i>

11.40 INT_DUR2 (5Ah)

Tap recognition function setting register (r/w)

Table 99. INT_DUR2 register

DUR3	DUR2	DUR1	DUR0	QUIET1	QUIET0	SHOCK1	SHOCK0
------	------	------	------	--------	--------	--------	--------

Table 100. INT_DUR2 register description

DUR[3:0]	Duration of maximum time gap for double tap recognition. Default: 0000 When double tap recognition is enabled, this register expresses the maximum time between two consecutive detected taps to determine a double tap event. The default value of these bits is 0000b which corresponds to 16/ODR_XL time. If the DUR[3:0] bits are set to a different value, 1LSB corresponds to 32/ODR_XL time.
QUIET[1:0]	Expected quiet time after a tap detection. Default value: 00 Quiet time is the time after the first detected tap in which there must not be any overthreshold event. The default value of these bits is 00b which corresponds to 2/ODR_XL time. If the QUIET[1:0] bits are set to a different value, 1LSB corresponds to 4/ODR_XL time.
SHOCK[1:0]	Maximum duration of overthreshold event. Default value: 00 Maximum duration is the maximum time of an overthreshold signal detection to be recognized as a tap event. The default value of these bits is 00b which corresponds to 4/ODR_XL time. If the SHOCK[1:0] bits are set to a different value, 1LSB corresponds to 8/ODR_XL time.

11.41 WAKE_UP_THS (5Bh)

Single/double-tap selection and wake-up configuration (r/w)

Table 101. WAKE_UP_THS register

SINGLE_ DOUBLE_TAP	USR_OFF_ ON_WU	WK_THS5	WK_THS4	WK_THS3	WK_THS2	WK_THS1	WK_THS0
--------------------	----------------	---------	---------	---------	---------	---------	---------

Table 102. WAKE_UP_THS register description

SINGLE_DOUBLE_TAP	Single/double-tap event enable. Default: 0 (0: only single-tap event enabled; 1: both single and double-tap events enabled)
USR_OFF_ON_WU	Drives the low-pass filtered data with user offset correction (instead of high-pass filtered data) to the wakeup function.
WK_THS[5:0]	Threshold for wakeup: 1 LSB weight depends on WAKE_THS_W in WAKE_UP_DUR (5Ch). Default value: 000000

11.42 WAKE_UP_DUR (5Ch)

Wake-up and sleep mode functions duration setting register (r/w)

Table 103. WAKE_UP_DUR register

0	WAKE_ DUR1	WAKE_ DUR0	WAKE_ THS_W	SLEEP_ DUR3	SLEEP_ DUR2	SLEEP_ DUR1	SLEEP_ DUR0
---	------------	------------	-------------	-------------	-------------	-------------	-------------

Table 104. WAKE_UP_DUR register description

WAKE_DUR[1:0]	Wake up duration event. Default: 00 1LSB = 1 ODR_time
WAKE_THS_W	Weight of 1 LSB of wakeup threshold. Default: 0 (0: 1 LSB = $FS_XL / (2^6)$; 1: 1 LSB = $FS_XL / (2^8)$) <i>Note: If selecting $FS_XL = \pm 3 g$ then: if $WAKE_THS_W = 0$, 1 LSB = $4 / 2^6 g$; if $WAKE_THS_W = 1$, 1 LSB = $4 / 2^8 g$.</i>
SLEEP_DUR[3:0]	Duration to go in sleep mode. Default value: 0000 (this corresponds to 16 ODR) 1 LSB = 512 ODR

11.43 MD1_CFG (5Eh)

Functions routing on INT1 register (r/w)

Table 105. MD1_CFG register

INT1_SLEEP_CHANGE	INT1_SINGLE_TAP	INT1_WU	0 ⁽¹⁾	INT1_DOUBLE_TAP	0 ⁽¹⁾	INT1_EMB_FUNC	INT1_SHUB
-------------------	-----------------	---------	------------------	-----------------	------------------	---------------	-----------

1. This bit must be set to '0' for the correct operation of the device.

Table 106. MD1_CFG register description

INT1_SLEEP_CHANGE ⁽¹⁾	Routing of stationary/motion recognition event on INT1. Default: 0 (0: routing of stationary/motion event on INT1 disabled; 1: routing of stationary/motion event on INT1 enabled)
INT1_SINGLE_TAP	Routing of single-tap recognition event on INT1. Default: 0 (0: routing of single-tap event on INT1 disabled; 1: routing of single-tap event on INT1 enabled)
INT1_WU	Routing of wakeup event on INT1. Default value: 0 (0: routing of wakeup event on INT1 disabled; 1: routing of wakeup event on INT1 enabled)
INT1_DOUBLE_TAP	Routing of double-tap event on INT1. Default value: 0 (0: routing of double-tap event on INT1 disabled; 1: routing of double-tap event on INT1 enabled)
INT1_EMB_FUNC	Routing of embedded functions event on INT1. Default value: 0 (0: routing of embedded functions event on INT1 disabled; 1: routing embedded functions event on INT1 enabled)
INT1_SHUB	Routing of sensor hub communication concluded event on INT1. Default value: 0 (0: routing of sensor hub communication concluded event on INT1 disabled; 1: routing of sensor hub communication concluded event on INT1 enabled)

1. Stationary/motion interrupt mode (sleep change or sleep status) depends on the SLEEP_STATUS_ON_INT bit in the TAP_CFG0 (56h) register.

11.44 MD2_CFG (5Fh)

Functions routing on INT2 register (r/w)

Table 107. MD2_CFG register

INT2_SLEEP_CHANGE	INT2_SINGLE_TAP	INT2_WU	0 ⁽¹⁾	INT2_DOUBLE_TAP	0 ⁽¹⁾	INT2_EMB_FUNC	INT2_TIMESTAMP
-------------------	-----------------	---------	------------------	-----------------	------------------	---------------	----------------

1. This bit must be set to '0' for the correct operation of the device.

Table 108. MD2_CFG register description

INT2_SLEEP_CHANGE ⁽¹⁾	Routing of stationary/motion recognition event on INT2. Default: 0 (0: routing of stationary/motion event on INT2 disabled; 1: routing of stationary/motion event on INT2 enabled)
INT2_SINGLE_TAP	Single-tap recognition routing on INT2. Default: 0 (0: routing of single-tap event on INT2 disabled; 1: routing of single-tap event on INT2 enabled)
INT2_WU	Routing of wakeup event on INT2. Default value: 0 (0: routing of wakeup event on INT2 disabled; 1: routing of wake-up event on INT2 enabled)
INT2_DOUBLE_TAP	Routing of double-tap event on INT2. Default value: 0 (0: routing of double-tap event on INT2 disabled; 1: routing of double-tap event on INT2 enabled)
INT2_EMB_FUNC	Routing of embedded functions event on INT2. Default value: 0 (0: routing of embedded functions event on INT2 disabled; 1: routing embedded functions event on INT2 enabled)
INT2_TIMESTAMP	Enables routing on INT2 pin of the alert for timestamp overflow within 6.4 ms.

1. Stationary/motion interrupt mode (sleep change or sleep status) depends on the SLEEP_STATUS_ON_INT bit in the TAP_CFG0 (56h) register.

11.45 INTERNAL_FREQ_FINE (63h)

Internal frequency register (r)

Table 109. INTERNAL_FREQ_FINE register

FREQ_FINE7	FREQ_FINE6	FREQ_FINE5	FREQ_FINE4	FREQ_FINE3	FREQ_FINE2	FREQ_FINE1	FREQ_FINE0
------------	------------	------------	------------	------------	------------	------------	------------

Table 110. INTERNAL_FREQ_FINE register description

FREQ_FINE[7:0]	Difference in percentage of the effective ODR (and timestamp rate) with respect to the typical. Step: 0.15%. 8-bit format, 2's complement.
----------------	--

The formula below can be used to calculate a better estimation of the actual ODR:

$$\text{ODR_Actual} = (6667 + ((0.0015 * \text{INTERNAL_FREQ_FINE}) * 6667)) / \text{ODR_Coeff}$$

Selected_ODR	ODR_Coeff
12.5	512
26	256
52	128
104	64
208	32
416	16
833	8

The Selected_ODR parameter has to be derived from the ODR_XL selection ([Table 38. Accelerometer ODR selection](#)) in order to estimate the accelerometer ODR.

11.46 X_OFS_USR (73h)

Accelerometer X-axis user offset correction (r/w). The offset value set in the X_OFS_USR offset register is internally subtracted from the acceleration value measured on the X-axis.

Table 111. X_OFS_USR register

X_OFS_USR_7	X_OFS_USR_6	X_OFS_USR_5	X_OFS_USR_4	X_OFS_USR_3	X_OFS_USR_2	X_OFS_USR_1	X_OFS_USR_0
-------------	-------------	-------------	-------------	-------------	-------------	-------------	-------------

Table 112. X_OFS_USR register description

X_OFS_USR_[7:0]	Accelerometer X-axis user offset correction expressed in two's complement, weight depends on USR_OFF_W in CTRL6_C (15h). The value must be in the range [-127 127].
-----------------	---

11.47 Y_OFS_USR (74h)

Accelerometer Y-axis user offset correction (r/w). The offset value set in the Y_OFS_USR offset register is internally subtracted from the acceleration value measured on the Y-axis.

Table 113. Y_OFS_USR register

Y_OFS_USR_7	Y_OFS_USR_6	Y_OFS_USR_5	Y_OFS_USR_4	Y_OFS_USR_3	Y_OFS_USR_2	Y_OFS_USR_1	Y_OFS_USR_0
-------------	-------------	-------------	-------------	-------------	-------------	-------------	-------------

Table 114. Y_OFS_USR register description

Y_OFS_USR_[7:0]	Accelerometer Y-axis user offset calibration expressed in 2's complement, weight depends on USR_OFF_W in CTRL6_C (15h). The value must be in the range [-127, +127].
-----------------	--

11.48 FIFO_DATA_OUT_TAG (78h)

FIFO tag register (r)

Table 115. FIFO_DATA_OUT_TAG register

TAG_SENSOR_4	TAG_SENSOR_3	TAG_SENSOR_2	TAG_SENSOR_1	TAG_SENSOR_0	TAG_CNT_1	TAG_CNT_0	TAG_PARITY
--------------	--------------	--------------	--------------	--------------	-----------	-----------	------------

Table 116. FIFO_DATA_OUT_TAG register description

TAG_SENSOR_[4:0]	Identifies the sensor in: FIFO_DATA_OUT_X_L (79h) and FIFO_DATA_OUT_X_H (7Ah), FIFO_DATA_OUT_Y_L (7Bh) and FIFO_DATA_OUT_Y_H (7Ch), and FIFO_DATA_OUT_Z_L (7Dh) and FIFO_DATA_OUT_Z_H (7Eh) For details, refer to Table 117.
TAG_CNT_[1:0]	2-bit counter which identifies sensor time slot
TAG_PARITY	Parity check of TAG content

Table 117. FIFO tag

TAG_SENSOR_[4:0]	Sensor name	
0x02	Accelerometer	
0x03	Temperature	
0x04	Timestamp	
0x05	CFG_Change	
0x06	Reserved	
0x07		
0x08		
0x09		
0x0A		
0x0B		
0x0C		
0x0D		
0x0E		Sensor Hub Slave 0
0x0F		Sensor Hub Slave 1
0x10	Sensor Hub Slave 2	
0x11	Sensor Hub Slave 3	
0x19	Sensor Hub Nack	

11.49 FIFO_DATA_OUT_X_L (79h) and FIFO_DATA_OUT_X_H (7Ah)

FIFO data output X (r)

Table 118. FIFO_DATA_OUT_X_H and FIFO_DATA_OUT_X_L registers

D15	D14	D13	D12	D11	D10	D9	D8
D7	D6	D5	D4	D3	D2	D1	D0

Table 119. FIFO_DATA_OUT_X_H and FIFO_DATA_OUT_X_L register description

D[15:0]	FIFO X-axis output
---------	--------------------

11.50 FIFO_DATA_OUT_Y_L (7Bh) and FIFO_DATA_OUT_Y_H (7Ch)

FIFO data output Y (r)

Table 120. FIFO_DATA_OUT_Y_H and FIFO_DATA_OUT_Y_L registers

D15	D14	D13	D12	D11	D10	D9	D8
D7	D6	D5	D4	D3	D2	D1	D0

Table 121. FIFO_DATA_OUT_Y_H and FIFO_DATA_OUT_Y_L register description

D[15:0]	FIFO Y-axis output
---------	--------------------

11.51 FIFO_DATA_OUT_Z_L (7Dh) and FIFO_DATA_OUT_Z_H (7Eh)

FIFO data output Z (r)

Table 122. FIFO_DATA_OUT_Z_H and FIFO_DATA_OUT_Z_L registers

D15	D14	D13	D12	D11	D10	D9	D8
D7	D6	D5	D4	D3	D2	D1	D0

Table 123. FIFO_DATA_OUT_Z_H and FIFO_DATA_OUT_Z_L register description

D[15:0]	FIFO Z-axis output
---------	--------------------

Note: Fields related to the Z-axis are intended for usage in conjunction with an external sensor.

12 Embedded functions register map

The table given below provides a list of the registers for the embedded functions available in the device and the corresponding addresses. Embedded functions registers are accessible when FUNC_CFG_EN is set to '1' in FUNC_CFG_ACCESS (01h).

Table 124. Register address map - embedded functions

Name	Type	Register address		Default	Comment
		Hex	Binary		
PAGE_SEL	RW	02	00000010	00000001	
EMB_FUNC_EN_B	RW	05	00000101	00000000	
PAGE_ADDRESS	RW	08	00001000	00000000	
PAGE_VALUE	RW	09	00001001	00000000	
EMB_FUNC_INT1	RW	0A	00001010	00000000	
FSM_INT1_A	RW	0B	00001011	00000000	
FSM_INT1_B	RW	0C	00001100	00000000	
MLC_INT1	RW	0D	00001101	00000000	
EMB_FUNC_INT2	RW	0E	00001110	00000000	
FSM_INT2_A	R	0F	00001111	01101011	
FSM_INT2_B	RW	10	00010000	00000000	
MLC_INT2	RW	11	00010001	00000000	
EMB_FUNC_STATUS	R	12	00010010	output	
FSM_STATUS_A	R	13	00010011	output	
FSM_STATUS_B	R	14	00010100	output	
MLC_STATUS	R	15	00010101	output	
PAGE_RW	RW	17	00010111	00000000	
RESERVED	-	18-45			Reserved
FSM_ENABLE_A	RW	46	01000110	00000000	
FSM_ENABLE_B	RW	47	01000111	00000000	
FSM_LONG_COUNTER_L	RW	48	01001000	00000000	
FSM_LONG_COUNTER_H	RW	49	01001001	00000000	
FSM_LONG_COUNTER_CLEAR	RW	4A	01001010	00000000	
FSM_OUTS1	R	4C	01001100	output	
FSM_OUTS2	R	4D	01001101	output	
FSM_OUTS3	R	4E	01001110	output	
FSM_OUTS4	R	4F	01001111	output	
FSM_OUTS5	R	50	01010000	output	
FSM_OUTS6	R	51	01010001	output	
FSM_OUTS7	R	52	01010010	output	
FSM_OUTS8	R	53	01010011	output	
FSM_OUTS9	R	54	01010100	output	

Name	Type	Register address		Default	Comment
		Hex	Binary		
FSM_OUTS10	R	55	01010101	output	
FSM_OUTS11	R	56	01010110	output	
FSM_OUTS12	R	57	01010111	output	
FSM_OUTS13	R	58	01011000	output	
FSM_OUTS14	R	59	01011001	output	
FSM_OUTS15	R	5A	01011010	output	
FSM_OUTS16	R	5B	01011011	output	
RESERVED	-	5C-5E			Reserved
EMB_FUNC_ODR_CFG_B	RW	5F	01011111	01001011	
EMB_FUNC_ODR_CFG_C	RW	60	01100000	00010101	
RESERVED	-	61-66			Reserved
EMB_FUNC_INIT_B	RW	67	01100111	00000000	
MLC0_SRC	R	70	01110000	output	
MLC1_SRC	R	71	01110001	output	
MLC2_SRC	R	72	01110010	output	
MLC3_SRC	R	73	01110011	output	
MLC4_SRC	R	74	01110100	output	
MLC5_SRC	R	75	01110101	output	
MLC6_SRC	R	76	01110110	output	
MLC7_SRC	R	77	01110111	output	

Registers marked as Reserved must not be changed. Writing to those registers may cause permanent damage to the device.

The content of the registers that are loaded at boot should not be changed. They contain the factory calibration values. Their content is automatically restored when the device is powered up.

13 Embedded functions register description

13.1 PAGE_SEL (02h)

Enable advanced features dedicated page (r/w)

Table 125. PAGE_SEL register

PAGE_SEL3	PAGE_SEL2	PAGE_SEL1	PAGE_SEL0	0 ⁽¹⁾	0 ⁽¹⁾	0 ⁽¹⁾	1 ⁽²⁾
-----------	-----------	-----------	-----------	------------------	------------------	------------------	------------------

1. This bit must be set to '0' for the correct operation of the device.
2. This bit must be set to '1' for the correct operation of the device.

Table 126. PAGE_SEL register description

PAGE_SEL[3:0]	Select the advanced features dedicated page. Default value: 0000
---------------	--

13.2 EMB_FUNC_EN_B (05h)

Embedded functions enable register (r/w)

Table 127. EMB_FUNC_EN_B register

0 ⁽¹⁾	0 ⁽¹⁾	0 ⁽¹⁾	MLC_EN	0 ⁽¹⁾	0 ⁽¹⁾	0 ⁽¹⁾	FSM_EN
------------------	------------------	------------------	--------	------------------	------------------	------------------	--------

1. This bit must be set to '0' for the correct operation of the device.

Table 128. EMB_FUNC_EN_B register description

MLC_EN	Enable Machine Learning Core feature. Default value: 0 (0: Machine Learning Core feature disabled; 1: Machine Learning Core feature enabled)
FSM_EN	Enable Finite State Machine (FSM) feature. Default value: 0 (0: FSM feature disabled; 1: FSM feature enabled)

13.3 PAGE_ADDRESS (08h)

Page address register (r/w)

Table 129. PAGE_ADDRESS register

PAGE_ADDR7	PAGE_ADDR6	PAGE_ADDR5	PAGE_ADDR4	PAGE_ADDR3	PAGE_ADDR2	PAGE_ADDR1	PAGE_ADDR0
------------	------------	------------	------------	------------	------------	------------	------------

Table 130. PAGE_ADDRESS register description

PAGE_ADDR[7:0]	After setting the bit PAGE_WRITE / PAGE_READ in register PAGE_RW (17h), this register is used to set the address of the register to be written/read in the advanced features page selected through the bits PAGE_SEL[3:0] in register PAGE_SEL (02h).
----------------	---

13.4 PAGE_VALUE (09h)

Page value register (r/w)

Table 131. PAGE_VALUE register

PAGE_VALUE7	PAGE_VALUE6	PAGE_VALUE5	PAGE_VALUE4	PAGE_VALUE3	PAGE_VALUE2	PAGE_VALUE1	PAGE_VALUE0
-------------	-------------	-------------	-------------	-------------	-------------	-------------	-------------

Table 132. PAGE_VALUE register description

PAGE_VALUE[7:0]	These bits are used to write (if the bit PAGE_WRITE = 1 in register PAGE_RW (17h)) or read (if the bit PAGE_READ = 1 in register PAGE_RW (17h)) the data at the address PAGE_ADDR[7:0] of the selected advanced features page.
-----------------	--

13.5 EMB_FUNC_INT1 (0Ah)

INT1 pin control register (r/w)

Each bit in this register enables a signal to be carried over INT1. The pin's output will supply the OR combination of the selected signals.

Table 133. EMB_FUNC_INT1 register

INT1_FSM_LC	0 ⁽¹⁾	0 ⁽¹⁾	0 ⁽¹⁾	0 ⁽¹⁾	0 ⁽¹⁾	0 ⁽¹⁾	0 ⁽¹⁾
-------------	------------------	------------------	------------------	------------------	------------------	------------------	------------------

1. This bit must be set to '0' for the correct operation of the device.

Table 134. EMB_FUNC_INT1 register description

INT1_FSM_LC ⁽¹⁾	Routing of FSM long counter timeout interrupt event on INT1. Default value: 0 (0: routing on INT1 disabled; 1: routing on INT1 enabled)
----------------------------	---

1. This bit is effective if the INT1_EMB_FUNC bit of MD1_CFG (5Eh) is set to 1.

13.6 FSM_INT1_A (0Bh)

INT1 pin control register (r/w).

Each bit in this register enables a signal to be carried over INT1. The pin's output will supply the OR combination of the selected signals.

Table 135. FSM_INT1_A register

INT1_FSM8	INT1_FSM7	INT1_FSM6	INT1_FSM5	INT1_FSM4	INT1_FSM3	INT1_FSM2	INT1_FSM1
-----------	-----------	-----------	-----------	-----------	-----------	-----------	-----------

Table 136. FSM_INT1_A register description

INT1_FSM8 ⁽¹⁾	Routing of FSM8 interrupt event on INT1. Default value: 0 (0: routing on INT1 disabled; 1: routing on INT1 enabled)
INT1_FSM7 ⁽¹⁾	Routing of FSM7 interrupt event on INT1. Default value: 0 (0: routing on INT1 disabled; 1: routing on INT1 enabled)
INT1_FSM6 ⁽¹⁾	Routing of FSM6 interrupt event on INT1. Default value: 0 (0: routing on INT1 disabled; 1: routing on INT1 enabled)
INT1_FSM5 ⁽¹⁾	Routing of FSM5 interrupt event on INT1. Default value: 0 (0: routing on INT1 disabled; 1: routing on INT1 enabled)
INT1_FSM4 ⁽¹⁾	Routing of FSM4 interrupt event on INT1. Default value: 0 (0: routing on INT1 disabled; 1: routing on INT1 enabled)
INT1_FSM3 ⁽¹⁾	Routing of FSM3 interrupt event on INT1. Default value: 0 (0: routing on INT1 disabled; 1: routing on INT1 enabled)
INT1_FSM2 ⁽¹⁾	Routing of FSM2 interrupt event on INT1. Default value: 0 (0: routing on INT1 disabled; 1: routing on INT1 enabled)
INT1_FSM1 ⁽¹⁾	Routing of FSM1 interrupt event on INT1. Default value: 0 (0: routing on INT1 disabled; 1: routing on INT1 enabled)

1. This bit is effective if the INT1_EMB_FUNC bit of MD1_CFG (5Eh) is set to 1.

13.7 FSM_INT1_B (0Ch)

INT1 pin control register (r/w).

Each bit in this register enables a signal to be carried over INT1. The pin's output will supply the OR combination of the selected signals.

Table 137. FSM_INT1_B register

INT1_FSM16	INT1_FSM15	INT1_FSM14	INT1_FSM13	INT1_FSM12	INT1_FSM11	INT1_FSM10	INT1_FSM9
------------	------------	------------	------------	------------	------------	------------	-----------

Table 138. FSM_INT1_B register description

INT1_FSM16 ⁽¹⁾	Routing of FSM16 interrupt event on INT1. Default value: 0 (0: routing on INT1 disabled; 1: routing on INT1 enabled)
INT1_FSM15 ⁽¹⁾	Routing of FSM15 interrupt event on INT1. Default value: 0 (0: routing on INT1 disabled; 1: routing on INT1 enabled)
INT1_FSM14 ⁽¹⁾	Routing of FSM14 interrupt event on INT1. Default value: 0 (0: routing on INT1 disabled; 1: routing on INT1 enabled)
INT1_FSM13 ⁽¹⁾	Routing of FSM13 interrupt event on INT1. Default value: 0 (0: routing on INT1 disabled; 1: routing on INT1 enabled)
INT1_FSM12 ⁽¹⁾	Routing of FSM12 interrupt event on INT1. Default value: 0 (0: routing on INT1 disabled; 1: routing on INT1 enabled)
INT1_FSM11 ⁽¹⁾	Routing of FSM11 interrupt event on INT1. Default value: 0 (0: routing on INT1 disabled; 1: routing on INT1 enabled)
INT1_FSM10 ⁽¹⁾	Routing of FSM10 interrupt event on INT1. Default value: 0 (0: routing on INT1 disabled; 1: routing on INT1 enabled)
INT1_FSM9 ⁽¹⁾	Routing of FSM9 interrupt event on INT1. Default value: 0 (0: routing on INT1 disabled; 1: routing on INT1 enabled)

1. This bit is effective if the INT1_EMB_FUNC bit of MD1_CFG (5Eh) is set to 1.

13.8 MLC_INT1 (0Dh)

INT1 pin control register (r/w).

Each bit in this register enables a signal to be carried over INT1. The pin's output will supply the OR combination of the selected signals.

Table 139. MLC_INT1 register

INT1_MLC8	INT1_MLC7	INT1_MLC6	INT1_MLC5	INT1_MLC4	INT1_MLC3	INT1_MLC2	INT1_MLC1
-----------	-----------	-----------	-----------	-----------	-----------	-----------	-----------

Table 140. MLC_INT1 register description

INT1_MLC8	Routing of MLC8 interrupt event on INT1. Default value: 0 (0: routing on INT1 disabled; 1: routing on INT1 enabled)
INT1_MLC7	Routing of MLC7 interrupt event on INT1. Default value: 0 (0: routing on INT1 disabled; 1: routing on INT1 enabled)
INT1_MLC6	Routing of MLC6 interrupt event on INT1. Default value: 0 (0: routing on INT1 disabled; 1: routing on INT1 enabled)
INT1_MLC5	Routing of MLC5 interrupt event on INT1. Default value: 0 (0: routing on INT1 disabled; 1: routing on INT1 enabled)
INT1_MLC4	Routing of MLC4 interrupt event on INT1. Default value: 0 (0: routing on INT1 disabled; 1: routing on INT1 enabled)
INT1_MLC3	Routing of MLC3 interrupt event on INT1. Default value: 0 (0: routing on INT1 disabled; 1: routing on INT1 enabled)
INT1_MLC2	Routing of MLC2 interrupt event on INT1. Default value: 0 (0: routing on INT1 disabled; 1: routing on INT1 enabled)
INT1_MLC1	Routing of MLC1 interrupt event on INT1. Default value: 0 (0: routing on INT1 disabled; 1: routing on INT1 enabled)

13.9 EMB_FUNC_INT2 (0Eh)

INT2 pin control register (r/w).

Each bit in this register enables a signal to be carried over INT2. The pin's output will supply the OR combination of the selected signals.

Table 141. EMB_FUNC_INT2 register

INT2_FSM_LC	0 ⁽¹⁾	0 ⁽¹⁾	0 ⁽¹⁾	0 ⁽¹⁾	0 ⁽¹⁾	0 ⁽¹⁾	0 ⁽¹⁾
-------------	------------------	------------------	------------------	------------------	------------------	------------------	------------------

1. This bit must be set to '0' for the correct operation of the device.

Table 142. EMB_FUNC_INT2 register description

INT2_FSM_LC ⁽¹⁾	Routing of FSM long counter timeout interrupt event on INT2. Default value: 0 (0: routing on INT2 disabled; 1: routing on INT2 enabled)
----------------------------	--

1. This bit is effective if the INT2_EMB_FUNC bit of MD2_CFG (5Fh) is set to 1.

13.10 FSM_INT2_A (0Fh)

INT2 pin control register (r/w).

Each bit in this register enables a signal to be carried over INT2. The pin's output will supply the OR combination of the selected signals.

Table 143. FSM_INT2_A register

INT2_FSM8	INT2_FSM7	INT2_FSM6	INT2_FSM5	INT2_FSM4	INT2_FSM3	INT2_FSM2	INT2_FSM1
-----------	-----------	-----------	-----------	-----------	-----------	-----------	-----------

Table 144. FSM_INT2_A register description

INT2_FSM8 ⁽¹⁾	Routing of FSM8 interrupt event on INT2. Default value: 0 (0: routing on INT2 disabled; 1: routing on INT2 enabled)
INT2_FSM7 ⁽¹⁾	Routing of FSM7 interrupt event on INT2. Default value: 0 (0: routing on INT2 disabled; 1: routing on INT2 enabled)
INT2_FSM6 ⁽¹⁾	Routing of FSM6 interrupt event on INT2. Default value: 0 (0: routing on INT2 disabled; 1: routing on INT2 enabled)
INT2_FSM5 ⁽¹⁾	Routing of FSM5 interrupt event on INT2. Default value: 0 (0: routing on INT2 disabled; 1: routing on INT2 enabled)
INT2_FSM4 ⁽¹⁾	Routing of FSM4 interrupt event on INT2. Default value: 0 (0: routing on INT2 disabled; 1: routing on INT2 enabled)
INT2_FSM3 ⁽¹⁾	Routing of FSM3 interrupt event on INT2. Default value: 0 (0: routing on INT2 disabled; 1: routing on INT2 enabled) (0: routing on INT1 disabled; 1: routing on INT1 enabled)
INT2_FSM2 ⁽¹⁾	Routing of FSM2 interrupt event on INT2. Default value: 0 (0: routing on INT2 disabled; 1: routing on INT2 enabled)
INT2_FSM1 ⁽¹⁾	Routing of FSM1 interrupt event on INT2. Default value: 0 (0: routing on INT2 disabled; 1: routing on INT2 enabled)

1. This bit is effective if the INT2_EMB_FUNC bit of MD2_CFG (5Fh) is set to 1.

13.11 FSM_INT2_B (10h)

INT2 pin control register (r/w).

Each bit in this register enables a signal to be carried over INT2. The pin's output will supply the OR combination of the selected signals.

Table 145. FSM_INT2_B register

INT2_FSM16	INT2_FSM15	INT2_FSM14	INT2_FSM13	INT2_FSM12	INT2_FSM11	INT2_FSM10	INT2_FSM9
------------	------------	------------	------------	------------	------------	------------	-----------

Table 146. FSM_INT2_B register description

INT2_FSM16 ⁽¹⁾	Routing of FSM16 interrupt event on INT2. Default value: 0 (0: routing on INT2 disabled; 1: routing on INT2 enabled)
INT2_FSM15 ⁽¹⁾	Routing of FSM15 interrupt event on INT2. Default value: 0 (0: routing on INT2 disabled; 1: routing on INT2 enabled)
INT2_FSM14 ⁽¹⁾	Routing of FSM14 interrupt event on INT2. Default value: 0 (0: routing on INT2 disabled; 1: routing on INT2 enabled)
INT2_FSM13 ⁽¹⁾	Routing of FSM13 interrupt event on INT2. Default value: 0 (0: routing on INT2 disabled; 1: routing on INT2 enabled)
INT2_FSM12 ⁽¹⁾	Routing of FSM12 interrupt event on INT2. Default value: 0 (0: routing on INT2 disabled; 1: routing on INT2 enabled)
INT2_FSM11 ⁽¹⁾	Routing of FSM11 interrupt event on INT2. Default value: 0 (0: routing on INT2 disabled; 1: routing on INT2 enabled) (0: routing on INT1 disabled; 1: routing on INT1 enabled)
INT2_FSM10 ⁽¹⁾	Routing of FSM10 interrupt event on INT2. Default value: 0 (0: routing on INT2 disabled; 1: routing on INT2 enabled)
INT2_FSM9 ⁽¹⁾	Routing of FSM9 interrupt event on INT2. Default value: 0 (0: routing on INT2 disabled; 1: routing on INT2 enabled)

1. This bit is effective if the INT2_EMB_FUNC bit of MD2_CFG (5Fh) is set to 1.

13.12 MLC_INT2 (11h)

INT2 pin control register (r/w).

Each bit in this register enables a signal to be carried over INT2. The pin's output will supply the OR combination of the selected signals.

Table 147. MLC_INT2 register

INT2_MLC8	INT2_MLC7	INT2_MLC6	INT2_MLC5	INT2_MLC4	INT2_MLC3	INT2_MLC2	INT2_MLC1
-----------	-----------	-----------	-----------	-----------	-----------	-----------	-----------

Table 148. MLC_INT2 register description

INT2_MLC8	Routing of MLC8 interrupt event on INT2. Default value: 0 (0: routing on INT2 disabled; 1: routing on INT2 enabled)
INT2_MLC7	Routing of MLC7 interrupt event on INT2. Default value: 0 (0: routing on INT2 disabled; 1: routing on INT2 enabled)
INT2_MLC6	Routing of MLC6 interrupt event on INT2. Default value: 0 (0: routing on INT2 disabled; 1: routing on INT2 enabled)
INT2_MLC5	Routing of MLC5 interrupt event on INT2. Default value: 0 (0: routing on INT2 disabled; 1: routing on INT2 enabled)
INT2_MLC4	Routing of MLC4 interrupt event on INT2. Default value: 0 (0: routing on INT2 disabled; 1: routing on INT2 enabled)
INT2_MLC3	Routing of MLC3 interrupt event on INT2. Default value: 0 (0: routing on INT2 disabled; 1: routing on INT2 enabled)
INT2_MLC2	Routing of MLC2 interrupt event on INT2. Default value: 0 (0: routing on INT2 disabled; 1: routing on INT2 enabled)
INT2_MLC1	Routing of MLC1 interrupt event on INT2. Default value: 0 (0: routing on INT2 disabled; 1: routing on INT2 enabled)

13.13 EMB_FUNC_STATUS (12h)

Embedded function status register (r)

Table 149. EMB_FUNC_STATUS register

IS_FSM_LC	0	0	0	0	0	0	0
-----------	---	---	---	---	---	---	---

Table 150. EMB_FUNC_STATUS register description

IS_FSM_LC	Interrupt status bit for FSM long counter timeout interrupt event. (1: interrupt detected; 0: no interrupt)
-----------	--

13.14 FSM_STATUS_A (13h)

Finite State Machine status register (r)

Table 151. FSM_STATUS_A register

IS_FSM8	IS_FSM7	IS_FSM6	IS_FSM5	IS_FSM4	IS_FSM3	IS_FSM2	IS_FSM1
---------	---------	---------	---------	---------	---------	---------	---------

Table 152. FSM_STATUS_A register description

IS_FSM8	Interrupt status bit for FSM8 interrupt event. (1: interrupt detected; 0: no interrupt)
IS_FSM7	Interrupt status bit for FSM7 interrupt event. (1: interrupt detected; 0: no interrupt)
IS_FSM6	Interrupt status bit for FSM6 interrupt event. (1: interrupt detected; 0: no interrupt)
IS_FSM5	Interrupt status bit for FSM5 interrupt event. (1: interrupt detected; 0: no interrupt)
IS_FSM4	Interrupt status bit for FSM4 interrupt event. (1: interrupt detected; 0: no interrupt)
IS_FSM3	Interrupt status bit for FSM3 interrupt event. (1: interrupt detected; 0: no interrupt)
IS_FSM2	Interrupt status bit for FSM2 interrupt event. (1: interrupt detected; 0: no interrupt)
IS_FSM1	Interrupt status bit for FSM1 interrupt event. (1: interrupt detected; 0: no interrupt)

13.15 FSM_STATUS_B (14h)

Finite State Machine status register (r)

Table 153. FSM_STATUS_B register

IS_FSM16	IS_FSM15	IS_FSM14	IS_FSM13	IS_FSM12	IS_FSM11	IS_FSM10	IS_FSM9
----------	----------	----------	----------	----------	----------	----------	---------

Table 154. FSM_STATUS_B register description

IS_FSM16	Interrupt status bit for FSM16 interrupt event. (1: interrupt detected; 0: no interrupt)
IS_FSM15	Interrupt status bit for FSM15 interrupt event. (1: interrupt detected; 0: no interrupt)
IS_FSM14	Interrupt status bit for FSM14 interrupt event. (1: interrupt detected; 0: no interrupt)
IS_FSM13	Interrupt status bit for FSM13 interrupt event. (1: interrupt detected; 0: no interrupt)
IS_FSM12	Interrupt status bit for FSM12 interrupt event. (1: interrupt detected; 0: no interrupt)
IS_FSM11	Interrupt status bit for FSM11 interrupt event. (1: interrupt detected; 0: no interrupt)
IS_FSM10	Interrupt status bit for FSM10 interrupt event. (1: interrupt detected; 0: no interrupt)
IS_FSM9	Interrupt status bit for FSM9 interrupt event. (1: interrupt detected; 0: no interrupt)

13.16 MLC_STATUS (15h)

Machine Learning Core status register (r)

Table 155. MLC_STATUS register

IS_MLC8	IS_MLC7	IS_MLC6	IS_MLC5	IS_MLC4	IS_MLC3	IS_MLC2	IS_MLC1
---------	---------	---------	---------	---------	---------	---------	---------

Table 156. MLC_STATUS register description

IS_MLC8	Interrupt status bit for MLC8 interrupt event. (1: interrupt detected; 0: no interrupt)
IS_MLC7	Interrupt status bit for MLC7 interrupt event. (1: interrupt detected; 0: no interrupt)
IS_MLC6	Interrupt status bit for MLC6 interrupt event. (1: interrupt detected; 0: no interrupt)
IS_MLC5	Interrupt status bit for MLC5 interrupt event. (1: interrupt detected; 0: no interrupt)
IS_MLC4	Interrupt status bit for MLC4 interrupt event. (1: interrupt detected; 0: no interrupt)
IS_MLC3	Interrupt status bit for MLC3 interrupt event. (1: interrupt detected; 0: no interrupt)
IS_MLC2	Interrupt status bit for MLC2 interrupt event. (1: interrupt detected; 0: no interrupt)
IS_MLC1	Interrupt status bit for MLC1 interrupt event. (1: interrupt detected; 0: no interrupt)

13.17 PAGE_RW (17h)

Enable read and write mode of advanced features dedicated page (r/w)

Table 157. PAGE_RW register

EMB_FUNC_LIR	PAGE_WRITE	PAGE_READ	0 ⁽¹⁾	0 ⁽¹⁾	0 ⁽¹⁾	0 ⁽¹⁾	0 ⁽¹⁾
--------------	------------	-----------	------------------	------------------	------------------	------------------	------------------

1. This bit must be set to '0' for the correct operation of the device.

Table 158. PAGE_RW register description

EMB_FUNC_LIR	Latched Interrupt mode for Embedded Functions. Default value: 0 (0: Embedded Functions interrupt request not latched; 1: Embedded Functions interrupt request latched)
PAGE_WRITE	Enable writes to the selected advanced features dedicated page. ⁽¹⁾ Default value: 0 (1: enable; 0: disable)
PAGE_READ	Enable reads from the selected advanced features dedicated page. ⁽¹⁾ Default value: 0 (1: enable; 0: disable)

1. Page selected by PAGE_SEL[3:0] in PAGE_SEL (02h) register.

13.18 FSM_ENABLE_A (46h)

FSM enable register (r/w)

Table 159. FSM_ENABLE_A register

FSM8_EN	FSM7_EN	FSM6_EN	FSM5_EN	FSM4_EN	FSM3_EN	FSM2_EN	FSM1_EN
---------	---------	---------	---------	---------	---------	---------	---------

Table 160. FSM_ENABLE_A register description

FSM8_EN	FSM8 enable. Default value: 0 (0: FSM8 disabled; 1: FSM8 enabled)
FSM7_EN	FSM7 enable. Default value: 0 (0: FSM7 disabled; 1: FSM7 enabled)
FSM6_EN	FSM6 enable. Default value: 0 (0: FSM6 disabled; 1: FSM6 enabled)
FSM5_EN	FSM5 enable. Default value: 0 (0: FSM5 disabled; 1: FSM5 enabled)
FSM4_EN	FSM4 enable. Default value: 0 (0: FSM4 disabled; 1: FSM4 enabled)
FSM3_EN	FSM3 enable. Default value: 0 (0: FSM3 disabled; 1: FSM3 enabled)
FSM2_EN	FSM2 enable. Default value: 0 (0: FSM2 disabled; 1: FSM2 enabled)
FSM1_EN	FSM1 enable. Default value: 0 (0: FSM1 disabled; 1: FSM1 enabled)

13.19 FSM_ENABLE_B (47h)

FSM enable register (r/w)

Table 161. FSM_ENABLE_B register

FSM16_EN	FSM15_EN	FSM14_EN	FSM13_EN	FSM12_EN	FSM11_EN	FSM10_EN	FSM9_EN
----------	----------	----------	----------	----------	----------	----------	---------

Table 162. FSM_ENABLE_B register description

FSM16_EN	FSM16 enable. Default value: 0 (0: FSM16 disabled; 1: FSM16 enabled)
FSM15_EN	FSM15 enable. Default value: 0 (0: FSM15 disabled; 1: FSM15 enabled)
FSM14_EN	FSM14 enable. Default value: 0 (0: FSM14 disabled; 1: FSM14 enabled)
FSM13_EN	FSM13 enable. Default value: 0 (0: FSM13 disabled; 1: FSM13 enabled)
FSM12_EN	FSM12 enable. Default value: 0 (0: FSM12 disabled; 1: FSM12 enabled)
FSM11_EN	FSM11 enable. Default value: 0 (0: FSM11 disabled; 1: FSM11 enabled)
FSM10_EN	FSM10 enable. Default value: 0 (0: FSM10 disabled; 1: FSM10 enabled)
FSM9_EN	FSM9 enable. Default value: 0 (0: FSM9 disabled; 1: FSM9 enabled)

13.20 FSM_LONG_COUNTER_L (48h) and FSM_LONG_COUNTER_H (49h)

FSM long counter status register (r/w).

Long counter value is an unsigned integer value (16-bit format); this value can be reset using the LC_CLEAR bit in the FSM_LONG_COUNTER_CLEAR (4Ah) register.

Table 163. FSM_LONG_COUNTER_L register

FSM_LC_7	FSM_LC_6	FSM_LC_5	FSM_LC_4	FSM_LC_3	FSM_LC_2	FSM_LC_1	FSM_LC_0
----------	----------	----------	----------	----------	----------	----------	----------

Table 164. FSM_LONG_COUNTER_L register description

FSM_LC_[7:0]	Long counter current value (LSbyte). Default value: 00000000
--------------	--

Table 165. FSM_LONG_COUNTER_H register

FSM_LC_15	FSM_LC_14	FSM_LC_13	FSM_LC_12	FSM_LC_11	FSM_LC_10	FSM_LC_9	FSM_LC_8
-----------	-----------	-----------	-----------	-----------	-----------	----------	----------

Table 166. FSM_LONG_COUNTER_H register description

FSM_LC_[15:8]	Long counter current value (MSbyte). Default value: 00000000
---------------	--

13.21 FSM_LONG_COUNTER_CLEAR (4Ah)

FSM long counter reset register (r/w)

Table 167. FSM_LONG_COUNTER_CLEAR register

0 ⁽¹⁾	0 ⁽¹⁾	0 ⁽¹⁾	0 ⁽¹⁾	0 ⁽¹⁾	0 ⁽¹⁾	FSM_LC_CLEARED	FSM_LC_CLEAR
------------------	------------------	------------------	------------------	------------------	------------------	----------------	--------------

1. This bit must be set to '0' for the correct operation of the device.

Table 168. FSM_LONG_COUNTER_CLEAR register description

FSM_LC_CLEARED	This read-only bit is automatically set to 1 when the long counter reset is done. Default value: 0
FSM_LC_CLEAR	Clear FSM long counter value. Default value: 0

13.22 FSM_OUTS1 (4Ch)

FSM1 output register (r)

Table 169. FSM_OUTS1 register

P_X	N_X	P_Y	N_Y	P_Z	N_Z	P_V	N_V
-----	-----	-----	-----	-----	-----	-----	-----

Table 170. FSM_OUTS1 register description

P_X	FSM1 output: positive event detected on the X-axis. (0: event not detected; 1: event detected)
N_X	FSM1 output: negative event detected on the X-axis. (0: event not detected; 1: event detected)
P_Y	FSM1 output: positive event detected on the Y-axis. (0: event not detected; 1: event detected)
N_Y	FSM1 output: negative event detected on the Y-axis. (0: event not detected; 1: event detected)
P_Z	FSM1 output: positive event detected on the Z-axis. (0: event not detected; 1: event detected)
N_Z	FSM1 output: negative event detected on the Z-axis. (0: event not detected; 1: event detected)
P_V	FSM1 output: positive event detected on the vector. (0: event not detected; 1: event detected)
N_V	FSM1 output: negative event detected on the vector. (0: event not detected; 1: event detected)

Note: Fields related to the Z-axis are intended for use in conjunction with an external sensor.

13.23 FSM_OUTS2 (4Dh)

FSM2 output register (r)

Table 171. FSM_OUTS2 register

P_X	N_X	P_Y	N_Y	P_Z	N_Z	P_V	N_V
-----	-----	-----	-----	-----	-----	-----	-----

Table 172. FSM_OUTS2 register description

P_X	FSM2 output: positive event detected on the X-axis. (0: event not detected; 1: event detected)
N_X	FSM2 output: negative event detected on the X-axis. (0: event not detected; 1: event detected)
P_Y	FSM2 output: positive event detected on the Y-axis. (0: event not detected; 1: event detected)
N_Y	FSM2 output: negative event detected on the Y-axis. (0: event not detected; 1: event detected)
P_Z	FSM2 output: positive event detected on the Z-axis. (0: event not detected; 1: event detected)
N_Z	FSM2 output: negative event detected on the Z-axis. (0: event not detected; 1: event detected)
P_V	FSM2 output: positive event detected on the vector. (0: event not detected; 1: event detected)
N_V	FSM2 output: negative event detected on the vector. (0: event not detected; 1: event detected)

Note: Fields related to the Z-axis are intended for use in conjunction with an external sensor.

13.24 FSM_OUTS3 (4Eh)

FSM3 output register (r)

Table 173. FSM_OUTS3 register

P_X	N_X	P_Y	N_Y	P_Z	N_Z	P_V	N_V
-----	-----	-----	-----	-----	-----	-----	-----

Table 174. FSM_OUTS3 register description

P_X	FSM3 output: positive event detected on the X-axis. (0: event not detected; 1: event detected)
N_X	FSM3 output: negative event detected on the X-axis. (0: event not detected; 1: event detected)
P_Y	FSM3 output: positive event detected on the Y-axis. (0: event not detected; 1: event detected)
N_Y	FSM3 output: negative event detected on the Y-axis. (0: event not detected; 1: event detected)
P_Z	FSM3 output: positive event detected on the Z-axis. (0: event not detected; 1: event detected)
N_Z	FSM3 output: negative event detected on the Z-axis. (0: event not detected; 1: event detected)
P_V	FSM3 output: positive event detected on the vector. (0: event not detected; 1: event detected)
N_V	FSM3 output: negative event detected on the vector. (0: event not detected; 1: event detected)

Note: Fields related to the Z-axis are intended for use in conjunction with an external sensor.

13.25 FSM_OUTS4 (4Fh)

FSM4 output register (r)

Table 175. FSM_OUTS4 register

P_X	N_X	P_Y	N_Y	P_Z	N_Z	P_V	N_V
-----	-----	-----	-----	-----	-----	-----	-----

Table 176. FSM_OUTS4 register description

P_X	FSM4 output: positive event detected on the X-axis. (0: event not detected; 1: event detected)
N_X	FSM4 output: negative event detected on the X-axis. (0: event not detected; 1: event detected)
P_Y	FSM4 output: positive event detected on the Y-axis. (0: event not detected; 1: event detected)
N_Y	FSM4 output: negative event detected on the Y-axis. (0: event not detected; 1: event detected)
P_Z	FSM4 output: positive event detected on the Z-axis. (0: event not detected; 1: event detected)
N_Z	FSM4 output: negative event detected on the Z-axis. (0: event not detected; 1: event detected)
P_V	FSM4 output: positive event detected on the vector. (0: event not detected; 1: event detected)
N_V	FSM4 output: negative event detected on the vector. (0: event not detected; 1: event detected)

Note: Fields related to the Z-axis are intended for use in conjunction with an external sensor.

13.26 FSM_OUTS5 (50h)

FSM5 output register (r)

Table 177. FSM_OUTS5 register

P_X	N_X	P_Y	N_Y	P_Z	N_Z	P_V	N_V
-----	-----	-----	-----	-----	-----	-----	-----

Table 178. FSM_OUTS5 register description

P_X	FSM5 output: positive event detected on the X-axis. (0: event not detected; 1: event detected)
N_X	FSM5 output: negative event detected on the X-axis. (0: event not detected; 1: event detected)
P_Y	FSM5 output: positive event detected on the Y-axis. (0: event not detected; 1: event detected)
N_Y	FSM5 output: negative event detected on the Y-axis. (0: event not detected; 1: event detected)
P_Z	FSM5 output: positive event detected on the Z-axis. (0: event not detected; 1: event detected)
N_Z	FSM5 output: negative event detected on the Z-axis. (0: event not detected; 1: event detected)
P_V	FSM5 output: positive event detected on the vector. (0: event not detected; 1: event detected)
N_V	FSM5 output: negative event detected on the vector. (0: event not detected; 1: event detected)

Note: Fields related to the Z-axis are intended for use in conjunction with an external sensor.

13.27 FSM_OUTS6 (51h)

FSM6 output register (r)

Table 179. FSM_OUTS6 register

P_X	N_X	P_Y	N_Y	P_Z	N_Z	P_V	N_V
-----	-----	-----	-----	-----	-----	-----	-----

Table 180. FSM_OUTS6 register description

P_X	FSM6 output: positive event detected on the X-axis. (0: event not detected; 1: event detected)
N_X	FSM6 output: negative event detected on the X-axis. (0: event not detected; 1: event detected)
P_Y	FSM6 output: positive event detected on the Y-axis. (0: event not detected; 1: event detected)
N_Y	FSM6 output: negative event detected on the Y-axis. (0: event not detected; 1: event detected)
P_Z	FSM6 output: positive event detected on the Z-axis. (0: event not detected; 1: event detected)
N_Z	FSM6 output: negative event detected on the Z-axis. (0: event not detected; 1: event detected)
P_V	FSM6 output: positive event detected on the vector. (0: event not detected; 1: event detected)
N_V	FSM6 output: negative event detected on the vector. (0: event not detected; 1: event detected)

Note: Fields related to the Z-axis are intended for use in conjunction with an external sensor.

13.28 FSM_OUTS7 (52h)

FSM7 output register (r)

Table 181. FSM_OUTS7 register

P_X	N_X	P_Y	N_Y	P_Z	N_Z	P_V	N_V
-----	-----	-----	-----	-----	-----	-----	-----

Table 182. FSM_OUTS7 register description

P_X	FSM7 output: positive event detected on the X-axis. (0: event not detected; 1: event detected)
N_X	FSM7 output: negative event detected on the X-axis. (0: event not detected; 1: event detected)
P_Y	FSM7 output: positive event detected on the Y-axis. (0: event not detected; 1: event detected)
N_Y	FSM7 output: negative event detected on the Y-axis. (0: event not detected; 1: event detected)
P_Z	FSM7 output: positive event detected on the Z-axis. (0: event not detected; 1: event detected)
N_Z	FSM7 output: negative event detected on the Z-axis. (0: event not detected; 1: event detected)
P_V	FSM7 output: positive event detected on the vector. (0: event not detected; 1: event detected)
N_V	FSM7 output: negative event detected on the vector. (0: event not detected; 1: event detected)

Note: Fields related to the Z-axis are intended for use in conjunction with an external sensor.

13.29 FSM_OUTS8 (53h)

FSM8 output register (r)

Table 183. FSM_OUTS8 register

P_X	N_X	P_Y	N_Y	P_Z	N_Z	P_V	N_V
-----	-----	-----	-----	-----	-----	-----	-----

Table 184. FSM_OUTS8 register description

P_X	FSM8 output: positive event detected on the X-axis. (0: event not detected; 1: event detected)
N_X	FSM8 output: negative event detected on the X-axis. (0: event not detected; 1: event detected)
P_Y	FSM8 output: positive event detected on the Y-axis. (0: event not detected; 1: event detected)
N_Y	FSM8 output: negative event detected on the Y-axis. (0: event not detected; 1: event detected)
P_Z	FSM8 output: positive event detected on the Z-axis. (0: event not detected; 1: event detected)
N_Z	FSM8 output: negative event detected on the Z-axis. (0: event not detected; 1: event detected)
P_V	FSM8 output: positive event detected on the vector. (0: event not detected; 1: event detected)
N_V	FSM8 output: negative event detected on the vector. (0: event not detected; 1: event detected)

Note: Fields related to the Z-axis are intended for use in conjunction with an external sensor.

13.30 FSM_OUTS9 (54h)

FSM9 output register (r)

Table 185. FSM_OUTS9 register

P_X	N_X	P_Y	N_Y	P_Z	N_Z	P_V	N_V
-----	-----	-----	-----	-----	-----	-----	-----

Table 186. FSM_OUTS9 register description

P_X	FSM9 output: positive event detected on the X-axis. (0: event not detected; 1: event detected)
N_X	FSM9 output: negative event detected on the X-axis. (0: event not detected; 1: event detected)
P_Y	FSM9 output: positive event detected on the Y-axis. (0: event not detected; 1: event detected)
N_Y	FSM9 output: negative event detected on the Y-axis. (0: event not detected; 1: event detected)
P_Z	FSM9 output: positive event detected on the Z-axis. (0: event not detected; 1: event detected)
N_Z	FSM9 output: negative event detected on the Z-axis. (0: event not detected; 1: event detected)
P_V	FSM9 output: positive event detected on the vector. (0: event not detected; 1: event detected)
N_V	FSM9 output: negative event detected on the vector. (0: event not detected; 1: event detected)

Note: Fields related to the Z-axis are intended for use in conjunction with an external sensor.

13.31 FSM_OUTS10 (55h)

FSM10 output register (r)

Table 187. FSM_OUTS10 register

P_X	N_X	P_Y	N_Y	P_Z	N_Z	P_V	N_V
-----	-----	-----	-----	-----	-----	-----	-----

Table 188. FSM_OUTS10 register description

P_X	FSM10 output: positive event detected on the X-axis. (0: event not detected; 1: event detected)
N_X	FSM10 output: negative event detected on the X-axis. (0: event not detected; 1: event detected)
P_Y	FSM10 output: positive event detected on the Y-axis. (0: event not detected; 1: event detected)
N_Y	FSM10 output: negative event detected on the Y-axis. (0: event not detected; 1: event detected)
P_Z	FSM10 output: positive event detected on the Z-axis. (0: event not detected; 1: event detected)
N_Z	FSM10 output: negative event detected on the Z-axis. (0: event not detected; 1: event detected)
P_V	FSM10 output: positive event detected on the vector. (0: event not detected; 1: event detected)
N_V	FSM10 output: negative event detected on the vector. (0: event not detected; 1: event detected)

Note: Fields related to the Z-axis are intended for use in conjunction with an external sensor.

13.32 FSM_OUTS11 (56h)

FSM11 output register (r)

Table 189. FSM_OUTS11 register

P_X	N_X	P_Y	N_Y	P_Z	N_Z	P_V	N_V
-----	-----	-----	-----	-----	-----	-----	-----

Table 190. FSM_OUTS11 register description

P_X	FSM11 output: positive event detected on the X-axis. (0: event not detected; 1: event detected)
N_X	FSM11 output: negative event detected on the X-axis. (0: event not detected; 1: event detected)
P_Y	FSM11 output: positive event detected on the Y-axis. (0: event not detected; 1: event detected)
N_Y	FSM11 output: negative event detected on the Y-axis. (0: event not detected; 1: event detected)
P_Z	FSM11 output: positive event detected on the Z-axis. (0: event not detected; 1: event detected)
N_Z	FSM11 output: negative event detected on the Z-axis. (0: event not detected; 1: event detected)
P_V	FSM11 output: positive event detected on the vector. (0: event not detected; 1: event detected)
N_V	FSM11 output: negative event detected on the vector. (0: event not detected; 1: event detected)

Note: Fields related to the Z-axis are intended for use in conjunction with an external sensor.

13.33 FSM_OUTS12 (57h)

FSM12 output register (r)

Table 191. FSM_OUTS12 register

P_X	N_X	P_Y	N_Y	P_Z	N_Z	P_V	N_V
-----	-----	-----	-----	-----	-----	-----	-----

Table 192. FSM_OUTS12 register description

P_X	FSM12 output: positive event detected on the X-axis. (0: event not detected; 1: event detected)
N_X	FSM12 output: negative event detected on the X-axis. (0: event not detected; 1: event detected)
P_Y	FSM12 output: positive event detected on the Y-axis. (0: event not detected; 1: event detected)
N_Y	FSM12 output: negative event detected on the Y-axis. (0: event not detected; 1: event detected)
P_Z	FSM12 output: positive event detected on the Z-axis. (0: event not detected; 1: event detected)
N_Z	FSM12 output: negative event detected on the Z-axis. (0: event not detected; 1: event detected)
P_V	FSM12 output: positive event detected on the vector. (0: event not detected; 1: event detected)
N_V	FSM12 output: negative event detected on the vector. (0: event not detected; 1: event detected)

Note: Fields related to the Z-axis are intended for use in conjunction with an external sensor.

13.34 FSM_OUTS13 (58h)

FSM13 output register (r)

Table 193. FSM_OUTS13 register

P_X	N_X	P_Y	N_Y	P_Z	N_Z	P_V	N_V
-----	-----	-----	-----	-----	-----	-----	-----

Table 194. FSM_OUTS13 register description

P_X	FSM13 output: positive event detected on the X-axis. (0: event not detected; 1: event detected)
N_X	FSM13 output: negative event detected on the X-axis. (0: event not detected; 1: event detected)
P_Y	FSM13 output: positive event detected on the Y-axis. (0: event not detected; 1: event detected)
N_Y	FSM13 output: negative event detected on the Y-axis. (0: event not detected; 1: event detected)
P_Z	FSM13 output: positive event detected on the Z-axis. (0: event not detected; 1: event detected)
N_Z	FSM13 output: negative event detected on the Z-axis. (0: event not detected; 1: event detected)
P_V	FSM13 output: positive event detected on the vector. (0: event not detected; 1: event detected)
N_V	FSM13 output: negative event detected on the vector. (0: event not detected; 1: event detected)

Note: Fields related to the Z-axis are intended for use in conjunction with an external sensor.

13.35 FSM_OUTS14 (59h)

FSM14 output register (r)

Table 195. FSM_OUTS14 register

P_X	N_X	P_Y	N_Y	P_Z	N_Z	P_V	N_V
-----	-----	-----	-----	-----	-----	-----	-----

Table 196. FSM_OUTS14 register description

P_X	FSM14 output: positive event detected on the X-axis. (0: event not detected; 1: event detected)
N_X	FSM14 output: negative event detected on the X-axis. (0: event not detected; 1: event detected)
P_Y	FSM14 output: positive event detected on the Y-axis. (0: event not detected; 1: event detected)
N_Y	FSM14 output: negative event detected on the Y-axis. (0: event not detected; 1: event detected)
P_Z	FSM14 output: positive event detected on the Z-axis. (0: event not detected; 1: event detected)
N_Z	FSM14 output: negative event detected on the Z-axis. (0: event not detected; 1: event detected)
P_V	FSM14 output: positive event detected on the vector. (0: event not detected; 1: event detected)
N_V	FSM14 output: negative event detected on the vector. (0: event not detected; 1: event detected)

Note: Fields related to the Z-axis are intended for use in conjunction with an external sensor.

13.36 FSM_OUTS15 (5Ah)

FSM15 output register (r)

Table 197. FSM_OUTS15 register

P_X	N_X	P_Y	N_Y	P_Z	N_Z	P_V	N_V
-----	-----	-----	-----	-----	-----	-----	-----

Table 198. FSM_OUTS15 register description

P_X	FSM15 output: positive event detected on the X-axis. (0: event not detected; 1: event detected)
N_X	FSM15 output: negative event detected on the X-axis. (0: event not detected; 1: event detected)
P_Y	FSM15 output: positive event detected on the Y-axis. (0: event not detected; 1: event detected)
N_Y	FSM15 output: negative event detected on the Y-axis. (0: event not detected; 1: event detected)
P_Z	FSM15 output: positive event detected on the Z-axis. (0: event not detected; 1: event detected)
N_Z	FSM15 output: negative event detected on the Z-axis. (0: event not detected; 1: event detected)
P_V	FSM15 output: positive event detected on the vector. (0: event not detected; 1: event detected)
N_V	FSM15 output: negative event detected on the vector. (0: event not detected; 1: event detected)

Note: Fields related to the Z-axis are intended for use in conjunction with an external sensor.

13.37 FSM_OUTS16 (5Bh)

FSM16 output register (r)

Table 199. FSM_OUTS16 register

P_X	N_X	P_Y	N_Y	P_Z	N_Z	P_V	N_V
-----	-----	-----	-----	-----	-----	-----	-----

Table 200. FSM_OUTS16 register description

P_X	FSM16 output: positive event detected on the X-axis. (0: event not detected; 1: event detected)
N_X	FSM16 output: negative event detected on the X-axis. (0: event not detected; 1: event detected)
P_Y	FSM16 output: positive event detected on the Y-axis. (0: event not detected; 1: event detected)
N_Y	FSM16 output: negative event detected on the Y-axis. (0: event not detected; 1: event detected)
P_Z	FSM16 output: positive event detected on the Z-axis. (0: event not detected; 1: event detected)
N_Z	FSM16 output: negative event detected on the Z-axis. (0: event not detected; 1: event detected)
P_V	FSM16 output: positive event detected on the vector. (0: event not detected; 1: event detected)
N_V	FSM16 output: negative event detected on the vector. (0: event not detected; 1: event detected)

Note: Fields related to the Z-axis are intended for use in conjunction with an external sensor.

13.38 EMB_FUNC_ODR_CFG_B (5Fh)

Finite State Machine output data rate configuration register (r/w)

Table 201. EMB_FUNC_ODR_CFG_B register

0 ⁽¹⁾	1 ⁽²⁾	0 ⁽¹⁾	FSM_ODR1	FSM_ODR0	0 ⁽¹⁾	1 ⁽²⁾	1 ⁽²⁾
------------------	------------------	------------------	----------	----------	------------------	------------------	------------------

1. This bit must be set to '0' for the correct operation of the device.
2. This bit must be set to '1' for the correct operation of the device

Table 202. EMB_FUNC_ODR_CFG_B register description

FSM_ODR[1:0]	Finite State Machine ODR configuration: (00: 12.5 Hz; 01: 26 Hz (default); 10: 52 Hz; 11: 104 Hz)
--------------	---

13.39 EMB_FUNC_ODR_CFG_C (60h)

Machine Learning Core output data rate configuration register (r/w)

Table 203. EMB_FUNC_ODR_CFG_C register

0 ⁽¹⁾	0 ⁽¹⁾	MLC_ODR1	MLC_ODR0	0 ⁽¹⁾	1 ⁽²⁾	0 ⁽¹⁾	1 ⁽²⁾
------------------	------------------	----------	----------	------------------	------------------	------------------	------------------

1. This bit must be set to '0' for the correct operation of the device.
2. This bit must be set to '1' for the correct operation of the device.

Table 204. EMB_FUNC_ODR_CFG_C register description

MLC_ODR[1:0]	Machine Learning Core ODR configuration: (00: 12.5 Hz; 01: 26 Hz (default); 10: 52 Hz; 11: 104 Hz)
--------------	--

13.40 EMB_FUNC_INIT_B (67h)

Embedded functions initialization register (r/w)

Table 205. EMB_FUNC_INIT_B register

0 ⁽¹⁾	0 ⁽¹⁾	0 ⁽¹⁾	MLC_INIT	0 ⁽¹⁾	0 ⁽¹⁾	0 ⁽¹⁾	FSM_INIT
------------------	------------------	------------------	----------	------------------	------------------	------------------	----------

1. This bit must be set to '0' for the correct operation of the device.

Table 206. EMB_FUNC_INIT_B register description

MLC_INIT	Machine Learning Core initialization request. Default value: 0
FSM_INIT	FSM initialization request. Default value: 0

13.41 MLC0_SRC (70h)

Machine Learning Core source register (r)

Table 207. MLC0_SRC register

MLC0_SRC_7	MLC0_SRC_6	MLC0_SRC_5	MLC0_SRC_4	MLC0_SRC_3	MLC0_SRC_2	MLC0_SRC_1	MLC0_SRC_0
------------	------------	------------	------------	------------	------------	------------	------------

Table 208. MLC0_SRC register description

MLC0_SRC_[7:0]	Output value of MLC0 decision tree
----------------	------------------------------------

13.42 MLC1_SRC (71h)

Machine Learning Core source register (r)

Table 209. MLC1_SRC register

MLC1_SRC_7	MLC1_SRC_6	MLC1_SRC_5	MLC1_SRC_4	MLC1_SRC_3	MLC1_SRC_2	MLC1_SRC_1	MLC1_SRC_0
------------	------------	------------	------------	------------	------------	------------	------------

Table 210. MLC1_SRC register description

MLC1_SRC_[7:0]	Output value of MLC1 decision tree
----------------	------------------------------------

13.43 MLC2_SRC (72h)

Machine Learning Core source register (r)

Table 211. MLC2_SRC register

MLC2_SRC_7	MLC2_SRC_6	MLC2_SRC_5	MLC2_SRC_4	MLC2_SRC_3	MLC2_SRC_2	MLC2_SRC_1	MLC2_SRC_0
------------	------------	------------	------------	------------	------------	------------	------------

Table 212. MLC2_SRC register description

MLC2_SRC_[7:0]	Output value of MLC2 decision tree
----------------	------------------------------------

13.44 MLC3_SRC (73h)

Machine Learning Core source register (r)

Table 213. MLC3_SRC register

MLC3_SRC_7	MLC3_SRC_6	MLC3_SRC_5	MLC3_SRC_4	MLC3_SRC_3	MLC3_SRC_2	MLC3_SRC_1	MLC3_SRC_0
------------	------------	------------	------------	------------	------------	------------	------------

Table 214. MLC3_SRC register description

MLC3_SRC_[7:0]	Output value of MLC3 decision tree
----------------	------------------------------------

13.45 MLC4_SRC (74h)

Machine Learning Core source register (r)

Table 215. MLC4_SRC register

MLC4_SRC_7	MLC4_SRC_6	MLC4_SRC_5	MLC4_SRC_4	MLC4_SRC_3	MLC4_SRC_2	MLC4_SRC_1	MLC4_SRC_0
------------	------------	------------	------------	------------	------------	------------	------------

Table 216. MLC4_SRC register description

MLC4_SRC_[7:0]	Output value of MLC4 decision tree
----------------	------------------------------------

13.46 MLC5_SRC (75h)

Machine Learning Core source register (r)

Table 217. MLC5_SRC register

MLC5_SRC_7	MLC5_SRC_6	MLC5_SRC_5	MLC5_SRC_4	MLC5_SRC_3	MLC5_SRC_2	MLC5_SRC_1	MLC5_SRC_0
------------	------------	------------	------------	------------	------------	------------	------------

Table 218. MLC5_SRC register description

MLC5_SRC_[7:0]	Output value of MLC5 decision tree
----------------	------------------------------------

13.47 MLC6_SRC (76h)

Machine Learning Core source register (r)

Table 219. MLC6_SRC register

MLC6_SRC_7	MLC6_SRC_6	MLC6_SRC_5	MLC6_SRC_4	MLC6_SRC_3	MLC6_SRC_2	MLC6_SRC_1	MLC6_SRC_0
------------	------------	------------	------------	------------	------------	------------	------------

Table 220. MLC6_SRC register description

MLC6_SRC_[7:0]	Output value of MLC6 decision tree
----------------	------------------------------------

13.48 MLC7_SRC (77h)

Machine Learning Core source register (r)

Table 221. MLC7_SRC register

MLC7_SRC_7	MLC7_SRC_6	MLC7_SRC_5	MLC7_SRC_4	MLC7_SRC_3	MLC7_SRC_2	MLC7_SRC_1	MLC7_SRC_0
------------	------------	------------	------------	------------	------------	------------	------------

Table 222. MLC7_SRC register description

MLC7_SRC_[7:0]	Output value of MLC7 decision tree
----------------	------------------------------------

14 Embedded advanced features

The following table provides a list of the registers for the embedded advanced features page 1. These registers are accessible when PAGE_SEL[3:0] are set to 0001 in PAGE_SEL (02h).

Table 223. Register address map - embedded advanced features page 1

Name	Type	Register address		Default	Comment
		Hex	Binary		
FSM_LC_TIMEOUT_L	RW	7A	01111010	00000000	
FSM_LC_TIMEOUT_H	RW	7B	01111011	00000000	
FSM_PROGRAMS	RW	7C	01111100	00000000	
FSM_START_ADD_L	RW	7E	01111110	00000000	
FSM_START_ADD_H	RW	7F	01111111	00000000	

Registers marked as Reserved must not be changed. Writing to those registers may cause permanent damage to the device.

The content of the registers that are loaded at boot should not be changed. They contain the factory calibration values. Their content is automatically restored when the device is powered up.

Write procedure example:

Example: write value 01h register at address 7Ch (FSM_PROGRAMS) in Page 1

1. Write bit FUNC_CFG_EN = 1 in FUNC_CFG_ACCESS (01h) // Enable access to embedded functions registers
2. Write bit PAGE_WRITE = 1 in PAGE_RW (17h) register // Select write operation mode
3. Write 0001 in PAGE_SEL[3:0] field of register PAGE_SEL (02h) // Select page 1
4. Write 7Ch in PAGE_ADDR register (08h) // Set address
5. Write 06h in PAGE_DATA register (09h) // Set value to be written
6. Write bit PAGE_WRITE = 0 in PAGE_RW (17h) register // Write operation disabled
7. Write bit FUNC_CFG_EN = 0 in FUNC_CFG_ACCESS (01h) // Disable access to embedded functions registers

Read procedure example:

Example: read value of register at address 7Ch (FSM_PROGRAMS) in Page 1

1. Write bit FUNC_CFG_EN = 1 in FUNC_CFG_ACCESS (01h) // Enable access to embedded functions registers
2. Write bit PAGE_READ = 1 in PAGE_RW (17h) register // Select read operation mode
3. Write 0001 in PAGE_SEL[3:0] field of register PAGE_SEL (02h) // Select page 1
4. Write 7Ch in PAGE_ADDR register (08h) // Set address
5. Read value of PAGE_DATA register (09h) // Get register value
6. Write bit PAGE_READ = 0 in PAGE_RW (17h) register // Read operation disabled
7. Write bit FUNC_CFG_EN = 0 in FUNC_CFG_ACCESS (01h) // Disable access to embedded functions registers

Note: Steps 1 and 2 of both procedures are intended to be performed at the beginning of the procedure. Steps 6 and 7 of both procedures are intended to be performed at the end of the procedure. If the procedure involves multiple operations, only steps 3, 4 and 5 must be repeated for each operation. If, in particular, the multiple operations involve consecutive registers, only step 5 can be performed.

15 Embedded advanced features register description

15.1 Page 1 - Embedded advanced features registers

15.1.1 FSM_LC_TIMEOUT_L (7Ah) and FSM_LC_TIMEOUT_H (7Bh)

FSM long counter timeout register (r/w).

The long counter timeout value is an unsigned integer value (16-bit format). When the long counter value reaches this value, the FSM generates an interrupt.

Table 224. FSM_LC_TIMEOUT_L register

FSM_LC_TIMEOUT7	FSM_LC_TIMEOUT6	FSM_LC_TIMEOUT5	FSM_LC_TIMEOUT4	FSM_LC_TIMEOUT3	FSM_LC_TIMEOUT2	FSM_LC_TIMEOUT1	FSM_LC_TIMEOUT0
-----------------	-----------------	-----------------	-----------------	-----------------	-----------------	-----------------	-----------------

Table 225. FSM_LC_TIMEOUT_L register description

FSM_LC_TIMEOUT[7:0]	FSM long counter timeout value (LSbyte). Default value: 00000000
---------------------	--

Table 226. FSM_LC_TIMEOUT_H register

FSM_LC_TIMEOUT15	FSM_LC_TIMEOUT14	FSM_LC_TIMEOUT13	FSM_LC_TIMEOUT12	FSM_LC_TIMEOUT11	FSM_LC_TIMEOUT10	FSM_LC_TIMEOUT9	FSM_LC_TIMEOUT8
------------------	------------------	------------------	------------------	------------------	------------------	-----------------	-----------------

Table 227. FSM_LC_TIMEOUT_H register description

FSM_LC_TIMEOUT[15:8]	FSM long counter timeout value (MSbyte). Default value: 00000000
----------------------	--

15.1.2 FSM_PROGRAMS (7Ch)

FSM number of programs register (r/w)

Table 228. FSM_PROGRAMS register

FSM_N_PROG7	FSM_N_PROG6	FSM_N_PROG5	FSM_N_PROG4	FSM_N_PROG3	FSM_N_PROG2	FSM_N_PROG1	FSM_N_PROG0
-------------	-------------	-------------	-------------	-------------	-------------	-------------	-------------

Table 229. FSM_PROGRAMS register description

FSM_N_PROG[7:0]	Number of FSM programs; must be less than or equal to 16. Default value: 00000000
-----------------	---

15.1.3 FSM_START_ADD_L (7Eh) and FSM_START_ADD_H (7Fh)

FSM start address register (r/w). First available address is 0x033C.

Table 230. FSM_START_ADD_L register

FSM_START7	FSM_START6	FSM_START5	FSM_START4	FSM_START3	FSM_START2	FSM_START1	FSM_START0
------------	------------	------------	------------	------------	------------	------------	------------

Table 231. FSM_START_ADD_L register description

FSM_START[7:0]	FSM start address value (LSbyte). Default value: 00000000
----------------	---

Table 232. FSM_START_ADD_H register

FSM_START15	FSM_START14	FSM_START13	FSM_START12	FSM_START11	FSM_START10	FSM_START9	FSM_START8
-------------	-------------	-------------	-------------	-------------	-------------	------------	------------

Table 233. FSM_START_ADD_H register description

FSM_START[15:8]	FSM start address value (MSbyte). Default value: 00000000
-----------------	---

16 Sensor hub register map

The table given below provides a list of the registers for the sensor hub functions available in the device and the corresponding addresses. The sensor hub registers are accessible when bit SHUB_REG_ACCESS is set to '1' in FUNC_CFG_ACCESS (01h).

Table 234. Registers address map

Name	Type	Register address		Default	Comment
		Hex	Binary		
SENSOR_HUB_1	R	02	00000010	output	
SENSOR_HUB_2	R	03	00000011	output	
SENSOR_HUB_3	R	04	00000100	output	
SENSOR_HUB_4	R	05	00000101	output	
SENSOR_HUB_5	R	06	00000110	output	
SENSOR_HUB_6	R	07	00000111	output	
SENSOR_HUB_7	R	08	00001000	output	
SENSOR_HUB_8	R	09	00001001	output	
SENSOR_HUB_9	R	0A	00001010	output	
SENSOR_HUB_10	R	0B	00001011	output	
SENSOR_HUB_11	R	0C	00001100	output	
SENSOR_HUB_12	R	0D	00001101	output	
SENSOR_HUB_13	R	0E	00001110	output	
SENSOR_HUB_14	R	0F	00001111	output	
SENSOR_HUB_15	R	10	00010000	output	
SENSOR_HUB_16	R	11	00010001	output	
SENSOR_HUB_17	R	12	00010010	output	
SENSOR_HUB_18	R	13	00010011	output	
MASTER_CONFIG	RW	14	00010100	00000000	
SLV0_ADD	RW	15	00010101	00000000	
SLV0_SUBADD	RW	16	00010110	00000000	
SLV0_CONFIG	RW	17	00010111	00000000	
SLV1_ADD	RW	18	00011000	00000000	
SLV1_SUBADD	RW	19	00011001	00000000	
SLV1_CONFIG	RW	1A	00011010	00000000	
SLV2_ADD	RW	1B	00011011	00000000	
SLV2_SUBADD	RW	1C	00011100	00000000	
SLV2_CONFIG	RW	1D	00011101	00000000	
SLV3_ADD	RW	1E	00011110	00000000	
SLV3_SUBADD	RW	1F	00011111	00000000	
SLV3_CONFIG	RW	20	00100000	00000000	
DATAWRITE_SLV0	RW	21	00100001	00000000	
STATUS_MASTER	R	22	00100010	output	

Registers marked as Reserved must not be changed. Writing to those registers may cause permanent damage to the device.

The content of the registers that are loaded at boot should not be changed. They contain the factory calibration values. Their content is automatically restored when the device is powered up.

17 Sensor hub register description

17.1 SENSOR_HUB_1 (02h)

Sensor hub output register (r)

First byte associated to external sensors. The content of the register is consistent with the SLAVEx_CONFIG number of read operation configurations (for external sensors from x = 0 to x = 3).

Table 235. SENSOR_HUB_1 register

Sensor Hub1_7	Sensor Hub1_6	Sensor Hub1_5	Sensor Hub1_4	Sensor Hub1_3	Sensor Hub1_2	Sensor Hub1_1	Sensor Hub1_0
---------------	---------------	---------------	---------------	---------------	---------------	---------------	---------------

Table 236. SENSOR_HUB_1 register description

SensorHub1[7:0]	First byte associated to external sensors
-----------------	---

17.2 SENSOR_HUB_2 (03h)

Sensor hub output register (r)

Second byte associated to external sensors. The content of the register is consistent with the SLAVEx_CONFIG number of read operation configurations (for external sensors from x = 0 to x = 3).

Table 237. SENSOR_HUB_2 register

Sensor Hub2_7	Sensor Hub2_6	Sensor Hub2_5	Sensor Hub2_4	Sensor Hub2_3	Sensor Hub2_2	Sensor Hub2_1	Sensor Hub2_0
---------------	---------------	---------------	---------------	---------------	---------------	---------------	---------------

Table 238. SENSOR_HUB_2 register description

SensorHub2[7:0]	Second byte associated to external sensors
-----------------	--

17.3 SENSOR_HUB_3 (04h)

Sensor hub output register (r)

Third byte associated to external sensors. The content of the register is consistent with the SLAVEx_CONFIG number of read operation configurations (for external sensors from x = 0 to x = 3).

Table 239. SENSOR_HUB_3 register

Sensor Hub3_7	Sensor Hub3_6	Sensor Hub3_5	Sensor Hub3_4	Sensor Hub3_3	Sensor Hub3_2	Sensor Hub3_1	Sensor Hub3_0
---------------	---------------	---------------	---------------	---------------	---------------	---------------	---------------

Table 240. SENSOR_HUB_3 register description

SensorHub3[7:0]	Third byte associated to external sensors
-----------------	---

17.4 SENSOR_HUB_4 (05h)

Sensor hub output register (r)

Fourth byte associated to external sensors. The content of the register is consistent with the SLAVEx_CONFIG number of read operation configurations (for external sensors from x = 0 to x = 3).

Table 241. SENSOR_HUB_4 register

Sensor Hub4_7	Sensor Hub4_6	Sensor Hub4_5	Sensor Hub4_4	Sensor Hub4_3	Sensor Hub4_2	Sensor Hub4_1	Sensor Hub4_0
---------------	---------------	---------------	---------------	---------------	---------------	---------------	---------------

Table 242. SENSOR_HUB_4 register description

SensorHub4[7:0]	Fourth byte associated to external sensors
-----------------	--

17.5 SENSOR_HUB_5 (06h)

Sensor hub output register (r)

Fifth byte associated to external sensors. The content of the register is consistent with the SLAVEx_CONFIG number of read operation configurations (for external sensors from x = 0 to x = 3).

Table 243. SENSOR_HUB_5 register

Sensor Hub5_7	Sensor Hub5_6	Sensor Hub5_5	Sensor Hub5_4	Sensor Hub5_3	Sensor Hub5_2	Sensor Hub5_1	Sensor Hub5_0
---------------	---------------	---------------	---------------	---------------	---------------	---------------	---------------

Table 244. SENSOR_HUB_5 register description

SensorHub5[7:0]	Fifth byte associated to external sensors
-----------------	---

17.6 SENSOR_HUB_6 (07h)

Sensor hub output register (r)

Sixth byte associated to external sensors. The content of the register is consistent with the SLAVEx_CONFIG number of read operation configurations (for external sensors from x = 0 to x = 3).

Table 245. SENSOR_HUB_6 register

Sensor Hub6_7	Sensor Hub6_6	Sensor Hub6_5	Sensor Hub6_4	Sensor Hub6_3	Sensor Hub6_2	Sensor Hub6_1	Sensor Hub6_0
---------------	---------------	---------------	---------------	---------------	---------------	---------------	---------------

Table 246. SENSOR_HUB_6 register description

SensorHub6[7:0]	Sixth byte associated to external sensors
-----------------	---

17.7 SENSOR_HUB_7 (08h)

Sensor hub output register (r)

Seventh byte associated to external sensors. The content of the register is consistent with the SLAVEx_CONFIG number of read operation configurations (for external sensors from x = 0 to x = 3).

Table 247. SENSOR_HUB_7 register

Sensor Hub7_7	Sensor Hub7_6	Sensor Hub7_5	Sensor Hub7_4	Sensor Hub7_3	Sensor Hub7_2	Sensor Hub7_1	Sensor Hub7_0
---------------	---------------	---------------	---------------	---------------	---------------	---------------	---------------

Table 248. SENSOR_HUB_7 register description

SensorHub7[7:0]	Seventh byte associated to external sensors
-----------------	---

17.8 SENSOR_HUB_8 (09h)

Sensor hub output register (r)

Eighth byte associated to external sensors. The content of the register is consistent with the SLAVEx_CONFIG number of read operation configurations (for external sensors from x = 0 to x = 3).

Table 249. SENSOR_HUB_8 register

Sensor Hub8_7	Sensor Hub8_6	Sensor Hub8_5	Sensor Hub8_4	Sensor Hub8_3	Sensor Hub8_2	Sensor Hub8_1	Sensor Hub8_0
---------------	---------------	---------------	---------------	---------------	---------------	---------------	---------------

Table 250. SENSOR_HUB_8 register description

SensorHub8[7:0]	Eighth byte associated to external sensors
-----------------	--

17.9 SENSOR_HUB_9 (0Ah)

Sensor hub output register (r)

Ninth byte associated to external sensors. The content of the register is consistent with the SLAVEx_CONFIG number of read operation configurations (for external sensors from x = 0 to x = 3).

Table 251. SENSOR_HUB_9 register

Sensor Hub9_7	Sensor Hub9_6	Sensor Hub9_5	Sensor Hub9_4	Sensor Hub9_3	Sensor Hub9_2	Sensor Hub9_1	Sensor Hub9_0
---------------	---------------	---------------	---------------	---------------	---------------	---------------	---------------

Table 252. SENSOR_HUB_9 register description

SensorHub9[7:0]	Ninth byte associated to external sensors
-----------------	---

17.10 SENSOR_HUB_10 (0Bh)

Sensor hub output register (r)

Tenth byte associated to external sensors. The content of the register is consistent with the SLAVEx_CONFIG number of read operation configurations (for external sensors from x = 0 to x = 3).

Table 253. SENSOR_HUB_10 register

Sensor Hub10_7	Sensor Hub10_6	Sensor Hub10_5	Sensor Hub10_4	Sensor Hub10_3	Sensor Hub10_2	Sensor Hub10_1	Sensor Hub10_0
----------------	----------------	----------------	----------------	----------------	----------------	----------------	----------------

Table 254. SENSOR_HUB_10 register description

SensorHub10[7:0]	Tenth byte associated to external sensors
------------------	---

17.11 SENSOR_HUB_11 (0Ch)

Sensor hub output register (r)

Eleventh byte associated to external sensors. The content of the register is consistent with the SLAVEx_CONFIG number of read operation configurations (for external sensors from x = 0 to x = 3).

Table 255. SENSOR_HUB_11 register

Sensor Hub11_7	Sensor Hub11_6	Sensor Hub11_5	Sensor Hub11_4	Sensor Hub11_3	Sensor Hub11_2	Sensor Hub11_1	Sensor Hub11_0
----------------	----------------	----------------	----------------	----------------	----------------	----------------	----------------

Table 256. SENSOR_HUB_11 register description

SensorHub11[7:0]	Eleventh byte associated to external sensors
------------------	--

17.12 SENSOR_HUB_12 (0Dh)

Sensor hub output register (r)

Twelfth byte associated to external sensors. The content of the register is consistent with the SLAVEx_CONFIG number of read operation configurations (for external sensors from x = 0 to x = 3).

Table 257. SENSOR_HUB_12 register

Sensor Hub12_7	Sensor Hub12_6	Sensor Hub12_5	Sensor Hub12_4	Sensor Hub12_3	Sensor Hub12_2	Sensor Hub12_1	Sensor Hub12_0
----------------	----------------	----------------	----------------	----------------	----------------	----------------	----------------

Table 258. SENSOR_HUB_12 register description

SensorHub12[7:0]	Twelfth byte associated to external sensors
------------------	---

17.13 SENSOR_HUB_13 (0Eh)

Sensor hub output register (r)

Thirteenth byte associated to external sensors. The content of the register is consistent with the SLAVEx_CONFIG number of read operation configurations (for external sensors from x = 0 to x = 3).

Table 259. SENSOR_HUB_13 register

Sensor Hub13_7	Sensor Hub13_6	Sensor Hub13_5	Sensor Hub13_4	Sensor Hub13_3	Sensor Hub13_2	Sensor Hub13_1	Sensor Hub13_0
----------------	----------------	----------------	----------------	----------------	----------------	----------------	----------------

Table 260. SENSOR_HUB_13 register description

SensorHub13[7:0]	Thirteenth byte associated to external sensors
------------------	--

17.14 SENSOR_HUB_14 (0Fh)

Sensor hub output register (r)

Fourteenth byte associated to external sensors. The content of the register is consistent with the SLAVEx_CONFIG number of read operation configurations (for external sensors from x = 0 to x = 3).

Table 261. SENSOR_HUB_14 register

Sensor Hub14_7	Sensor Hub14_6	Sensor Hub14_5	Sensor Hub14_4	Sensor Hub14_3	Sensor Hub14_2	Sensor Hub14_1	Sensor Hub14_0
----------------	----------------	----------------	----------------	----------------	----------------	----------------	----------------

Table 262. SENSOR_HUB_14 register description

SensorHub14[7:0]	Fourteenth byte associated to external sensors
------------------	--

17.15 SENSOR_HUB_15 (10h)

Sensor hub output register (r)

Fifteenth byte associated to external sensors. The content of the register is consistent with the SLAVEx_CONFIG number of read operation configurations (for external sensors from x = 0 to x = 3).

Table 263. SENSOR_HUB_15 register

Sensor Hub15_7	Sensor Hub15_6	Sensor Hub15_5	Sensor Hub15_4	Sensor Hub15_3	Sensor Hub15_2	Sensor Hub15_1	Sensor Hub15_0
----------------	----------------	----------------	----------------	----------------	----------------	----------------	----------------

Table 264. SENSOR_HUB_15 register description

SensorHub15[7:0]	Fifteenth byte associated to external sensors
------------------	---

17.16 SENSOR_HUB_16 (11h)

Sensor hub output register (r)

Sixteenth byte associated to external sensors. The content of the register is consistent with the SLAVEx_CONFIG number of read operation configurations (for external sensors from x = 0 to x = 3).

Table 265. SENSOR_HUB_16 register

Sensor Hub16_7	Sensor Hub16_6	Sensor Hub16_5	Sensor Hub16_4	Sensor Hub16_3	Sensor Hub16_2	Sensor Hub16_1	Sensor Hub16_0
----------------	----------------	----------------	----------------	----------------	----------------	----------------	----------------

Table 266. SENSOR_HUB_16 register description

SensorHub16[7:0]	Sixteenth byte associated to external sensors
------------------	---

17.17 SENSOR_HUB_17 (12h)

Sensor hub output register (r)

Seventeenth byte associated to external sensors. The content of the register is consistent with the SLAVEx_CONFIG number of read operation configurations (for external sensors from x = 0 to x = 3).

Table 267. SENSOR_HUB_17 register

Sensor Hub17_7	Sensor Hub17_6	Sensor Hub17_5	Sensor Hub17_4	Sensor Hub17_3	Sensor Hub17_2	Sensor Hub17_1	Sensor Hub17_0
----------------	----------------	----------------	----------------	----------------	----------------	----------------	----------------

Table 268. SENSOR_HUB_17 register description

SensorHub17[7:0]	Seventeenth byte associated to external sensors
------------------	---

17.18 SENSOR_HUB_18 (13h)

Sensor hub output register (r)

Eighteenth byte associated to external sensors. The content of the register is consistent with the SLAVEx_CONFIG number of read operation configurations (for external sensors from x = 0 to x = 3).

Table 269. SENSOR_HUB_18 register

Sensor Hub18_7	Sensor Hub18_6	Sensor Hub18_5	Sensor Hub18_4	Sensor Hub18_3	Sensor Hub18_2	Sensor Hub18_1	Sensor Hub18_0
----------------	----------------	----------------	----------------	----------------	----------------	----------------	----------------

Table 270. SENSOR_HUB_18 register description

SensorHub18[7:0]	Eighteenth byte associated to external sensors
------------------	--

17.19 MASTER_CONFIG (14h)

Master configuration register (r/w)

Table 271. MASTER_CONFIG register

RST_MASTER_REGS	WRITE_ONCE	START_CONFIG	PASS_THROUGH_MODE	SHUB_PU_EN	MASTER_ON	AUX_SENS_ON1	AUX_SENS_ON0
-----------------	------------	--------------	-------------------	------------	-----------	--------------	--------------

Table 272. MASTER_CONFIG register description

RST_MASTER_REGS	Reset Master logic and output registers. Must be set to '1' and then set it to '0'. Default value: 0
WRITE_ONCE	Slave 0 write operation is performed only at the first sensor hub cycle. Default value: 0 (0: write operation for each sensor hub cycle; 1: write operation only for the first sensor hub cycle)
START_CONFIG	Sensor hub trigger signal selection. Default value: 0 (0: sensor hub trigger signal is the accelerometer data-ready; 1: sensor hub trigger signal external from INT2 pin)
PASS_THROUGH_MODE	I ² C interface pass-through. Default value: 0 (0: pass-through disabled; 1: pass-through enabled, main I ² C line is short-circuited with the auxiliary line)
SHUB_PU_EN	Master I ² C pull-up enable. Default value: 0 (0: internal pull-up on auxiliary I ² C line disabled; 1: internal pull-up on auxiliary I ² C line enabled)
MASTER_ON	Sensor hub I ² C master enable. Default: 0 (0: master I ² C of sensor hub disabled; 1: master I ² C of sensor hub enabled)
AUX_SENS_ON[1:0]	Number of external sensors to be read by the sensor hub. (00: one sensor (default); 01: two sensors; 10: three sensors; 11: four sensors)

17.20 SLV0_ADD (15h)

I²C slave address of the first external sensor (Sensor 1) register (r/w)

Table 273. SLV0_ADD register

slave0_add6	slave0_add5	slave0_add4	slave0_add3	slave0_add2	slave0_add1	slave0_add0	rw_0
-------------	-------------	-------------	-------------	-------------	-------------	-------------	------

Table 274. SLV0_ADD register description

slave0_add[6:0]	I ² C slave address of Sensor1 that can be read by the sensor hub. Default value: 0000000
rw_0	Read/write operation on Sensor 1. Default value: 0 (0: write operation; 1: read operation)

17.21 SLV0_SUBADD (16h)

Address of register on the first external sensor (Sensor 1) register (r/w)

Table 275. SLV0_SUBADD register

slave0_reg7	slave0_reg6	slave0_reg5	slave0_reg4	slave0_reg3	slave0_reg2	slave0_reg1	slave0_reg0
-------------	-------------	-------------	-------------	-------------	-------------	-------------	-------------

Table 276. SLV0_SUBADD register description

slave0_reg[7:0]	Address of register on Sensor1 that has to be read/written according to the rw_0 bit value in SLV0_ADD (15h) . Default value: 00000000
-----------------	--

17.22 SLAVE0_CONFIG (17h)

First external sensor (Sensor1) configuration and sensor hub settings register (r/w)

Table 277. SLAVE0_CONFIG register

SHUB_ODR_1	SHUB_ODR_0	0 ⁽¹⁾	0 ⁽¹⁾	BATCH_EXT_SENS_0_EN	Slave0_numop2	Slave0_numop1	Slave0_numop0
------------	------------	------------------	------------------	---------------------	---------------	---------------	---------------

1. This bit must be set to '0' for the correct operation of the device.

Table 278. SLAVE0_CONFIG register description

SHUB_ODR_[1:0]	Rate at which the master communicates. Default value: 00 (00: 104 Hz (or the accelerometer ODR if it is less than 104 Hz); 01: 52 Hz (or the accelerometer ODR if it is less than 52 Hz); 10: 26 Hz (or the accelerometer ODR if it is less than 26 Hz); 11: 12.5 Hz (or the accelerometer ODR if it is less than 12.5 Hz)
BATCH_EXT_SENS_0_EN	Enable FIFO data batching of first slave. Default value: 0
Slave0_numop[2:0]	Number of read operations on Sensor 1. Default value: 000

17.23 SLV1_ADD (18h)

I²C slave address of the second external sensor (Sensor 2) register (r/w)

Table 279. SLV1_ADD register

Slave1_add6	Slave1_add5	Slave1_add4	Slave1_add3	Slave1_add2	Slave1_add1	Slave1_add0	r_1
-------------	-------------	-------------	-------------	-------------	-------------	-------------	-----

Table 280. SLV1_ADD register description

Slave1_add[6:0]	I ² C slave address of Sensor 2 that can be read by the sensor hub. Default value: 0000000
r_1	Read operation on Sensor 2 enable. Default value: 0 (0: read operation disabled; 1: read operation enabled)

17.24 SLV1_SUBADD (19h)

Address of register on the second external sensor (Sensor 2) register (r/w)

Table 281. SLV1_SUBADD register

Slave1_ reg7	Slave1_ reg6	Slave1_ reg5	Slave1_ reg4	Slave1_ reg3	Slave1_ reg2	Slave1_ reg1	Slave1_ reg0
-----------------	-----------------	-----------------	-----------------	-----------------	-----------------	-----------------	-----------------

Table 282. SLV1_SUBADD register description

Slave1_reg[7:0]	Address of register on Sensor 2 that has to be read/written according to the r_1 bit value in SLV1_ADD (18h).
-----------------	---

17.25 SLAVE1_CONFIG (1Ah)

Second external sensor (Sensor 2) configuration register (r/w)

Table 283. SLAVE1_CONFIG register

0 ⁽¹⁾	0 ⁽¹⁾	0 ⁽¹⁾	0 ⁽¹⁾	BATCH_EXT_ SENS_1_EN	Slave1_ numop2	Slave1_ numop1	Slave1_ numop0
------------------	------------------	------------------	------------------	-------------------------	-------------------	-------------------	-------------------

1. This bit must be set to '0' for the correct operation of the device.

Table 284. SLAVE1_CONFIG register description

BATCH_EXT_SENS_1_EN	Enable FIFO data batching of second slave. Default value: 0
Slave1_numop[2:0]	Number of read operations on Sensor 2. Default value: 000

17.26 SLV2_ADD (1Bh)

I²C slave address of the third external sensor (Sensor 3) register (r/w)

Table 285. SLV2_ADD register

Slave2_ add6	Slave2_ add5	Slave2_ add4	Slave2_ add3	Slave2_ add2	Slave2_ add1	Slave2_ add0	r_2
-----------------	-----------------	-----------------	-----------------	-----------------	-----------------	-----------------	-----

Table 286. SLV2_ADD register description

Slave2_add[6:0]	I ² C slave address of Sensor 3 that can be read by the sensor hub.
r_2	Read operation on Sensor 3 enable. Default value: 0 (0: read operation disabled; 1: read operation enabled)

17.27 SLV2_SUBADD (1Ch)

Address of register on the third external sensor (Sensor 3) register (r/w)

Table 287. SLV2_SUBADD register

Slave2_reg7	Slave2_reg6	Slave2_reg5	Slave2_reg4	Slave2_reg3	Slave2_reg2	Slave2_reg1	Slave2_reg0
-------------	-------------	-------------	-------------	-------------	-------------	-------------	-------------

Table 288. SLV2_SUBADD register description

Slave2_reg[7:0]	Address of register on Sensor 3 that has to be read/written according to the r_2 bit value in SLV2_ADD (1Bh).
-----------------	---

17.28 SLAVE2_CONFIG (1Dh)

Third external sensor (Sensor 3) configuration register (r/w)

Table 289. SLAVE2_CONFIG register

0 ⁽¹⁾	0 ⁽¹⁾	0 ⁽¹⁾	0 ⁽¹⁾	BATCH_EXT_SENS_2_EN	Slave2_numop2	Slave2_numop1	Slave2_numop0
------------------	------------------	------------------	------------------	---------------------	---------------	---------------	---------------

1. This bit must be set to '0' for the correct operation of the device.

Table 290. SLAVE2_CONFIG register description

BATCH_EXT_SENS_2_EN	Enable FIFO data batching of third slave. Default value: 0
Slave2_numop[2:0]	Number of read operations on Sensor 3. Default value: 000

17.29 SLV3_ADD (1Eh)

I²C slave address of the fourth external sensor (Sensor 4) register (r/w)

Table 291. SLV3_ADD register

Slave3_add6	Slave3_add5	Slave3_add4	Slave3_add3	Slave3_add2	Slave3_add1	Slave3_add0	r_3
-------------	-------------	-------------	-------------	-------------	-------------	-------------	-----

Table 292. SLV3_ADD register description

Slave3_add[6:0]	I ² C slave address of Sensor 4 that can be read by the sensor hub.
r_3	Read operation on Sensor 4 enable. Default value: 0 (0: read operation disabled; 1: read operation enabled)

17.30 SLV3_SUBADD (1Fh)

Address of register on the fourth external sensor (Sensor 4) register (r/w)

Table 293. SLV3_SUBADD register

Slave3_reg7	Slave3_reg6	Slave3_reg5	Slave3_reg4	Slave3_reg3	Slave3_reg2	Slave3_reg1	Slave3_reg0
-------------	-------------	-------------	-------------	-------------	-------------	-------------	-------------

Table 294. SLV3_SUBADD register description

Slave3_reg[7:0]	Address of register on Sensor 4 that has to be read according to the r_3 bit value in SLV3_ADD (1Eh) .
-----------------	---

17.31 SLAVE3_CONFIG (20h)

Fourth external sensor (Sensor 4) configuration register (r/w)

Table 295. SLAVE3_CONFIG register

0 ⁽¹⁾	0 ⁽¹⁾	0 ⁽¹⁾	0 ⁽¹⁾	BATCH_EXT_SENS_3_EN	Slave3_numop2	Slave3_numop1	Slave3_numop0
------------------	------------------	------------------	------------------	---------------------	---------------	---------------	---------------

1. This bit must be set to '0' for the correct operation of the device.

Table 296. SLAVE3_CONFIG register description

BATCH_EXT_SENS_3_EN	Enable FIFO data batching of fourth slave. Default value: 0
Slave3_numop[2:0]	Number of read operations on Sensor 4. Default value: 000

17.32 DATAWRITE_SLV0 (21h)

Data to be written into the slave device register (r/w)

Table 297. DATAWRITE_SLV0 register

Slave0_dataw7	Slave0_dataw6	Slave0_dataw5	Slave0_dataw4	Slave0_dataw3	Slave0_dataw2	Slave0_dataw1	Slave0_dataw0
---------------	---------------	---------------	---------------	---------------	---------------	---------------	---------------

Table 298. DATAWRITE_SLV0 register description

Slave0_dataw[7:0]	Data to be written into the slave 0 device according to the rw_0 bit in register SLV0_ADD (15h) . Default value: 00000000
-------------------	---

17.33 STATUS_MASTER (22h)

Sensor hub source register (r)

Table 299. STATUS_MASTER register

WR_ONCE_DONE	SLAVE3_NACK	SLAVE2_NACK	SLAVE1_NACK	SLAVE0_NACK	0	0	SENS_HUB_ENDOP
--------------	-------------	-------------	-------------	-------------	---	---	----------------

Table 300. STATUS_MASTER register description

WR_ONCE_DONE	When the bit WRITE_ONCE in MASTER_CONFIG (14h) is configured as 1, this bit is set to 1 when the write operation on slave 0 has been performed and completed. Default value: 0
SLAVE3_NACK	This bit is set to 1 if Not acknowledge occurs on slave 3 communication. Default value: 0
SLAVE2_NACK	This bit is set to 1 if Not acknowledge occurs on slave 2 communication. Default value: 0
SLAVE1_NACK	This bit is set to 1 if Not acknowledge occurs on slave 1 communication. Default value: 0
SLAVE0_NACK	This bit is set to 1 if Not acknowledge occurs on slave 0 communication. Default value: 0
SENS_HUB_ENDOP	Sensor hub communication status. Default value: 0 (0: sensor hub communication not concluded; 1: sensor hub communication concluded)

18 Soldering information

The LGA package is compliant with the [ECOPACK](#), RoHS and "Green" standard.
It is qualified for soldering heat resistance according to JEDEC J-STD-020.
Land pattern and soldering recommendations are available at www.st.com/mems.

19 Package information

In order to meet environmental requirements, ST offers these devices in different grades of **ECOPACK** packages, depending on their level of environmental compliance. ECOPACK specifications, grade definitions and product status are available at: www.st.com. ECOPACK is an ST trademark.

19.1 LGA-16L package information

The IIS2ICLX is available in a high-performance (low-stress) ceramic cavity land grid array (CC LGA) package. Due to the use of epoxy glue for lid sealing, hermeticity is not guaranteed. Processing or use of this package in a harsh environment should be assessed by the customer.

Figure 27. Ceramic cavity LGA-16: package outline and mechanical data

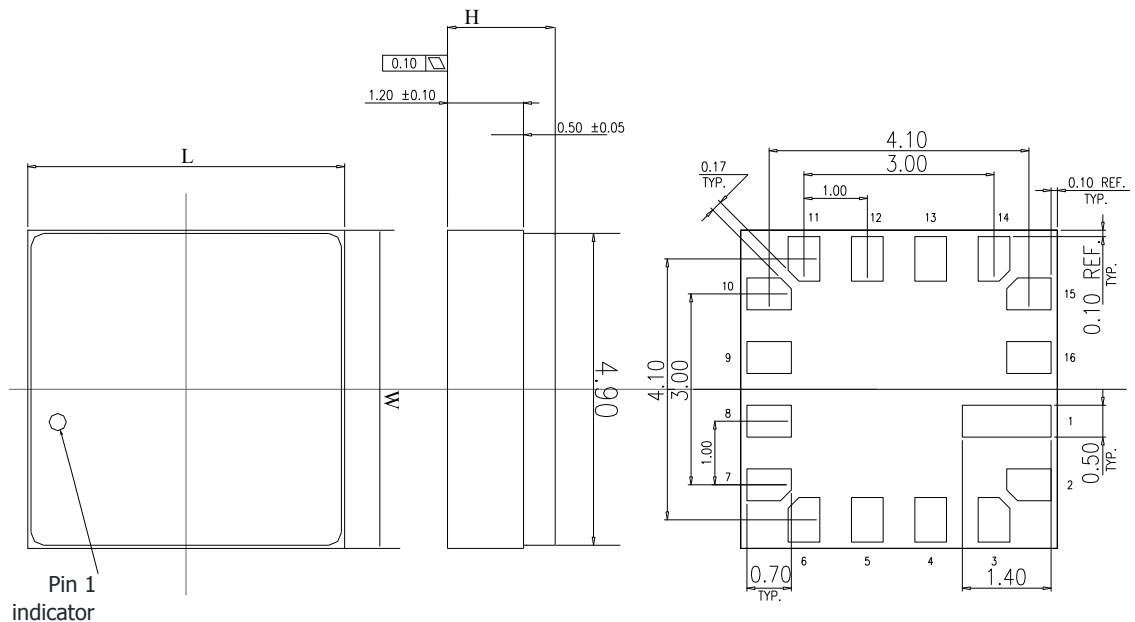

8535893_A

Note: Top and bottom view: dimensions are expressed in mm.

Table 301. Outer dimensions

Item	Dimension [mm]	Tolerance [mm]
Length [L]	5	±0.15
Width [W]	5	±0.15
Height [H]	1.7 typ	±0.15
Pad size	0.7 x 0.5	±0.15

Note: General tolerance is ±0.1 mm unless otherwise specified.

Revision history

Table 302. Document revision history

Date	Version	Changes
27-May-2020	1	Initial release
09-Jun-2020	2	Updated title of datasheet
18-Jun-2020	3	Updated CS pin in Table 16. Internal pin status and added procedure to initialize the device Added DEVICE_CONF bit to CTRL9_XL Updated description of X-axis tap recognition threshold in TAP_CFG1 (57h) Updated description of Y-axis tap recognition threshold in TAP_CFG2 (58h) Updated description of weight of 1 LSB of wakeup threshold in WAKE_UP_DUR (5Ch)
20-Aug-2020	4	Updated description of BDR_XL_[3:0] in FIFO_CTRL3 (09h) Updated description of ODR_T_BATCH_[1:0] in FIFO_CTRL4 (0Ah) Updated Table 48. CTRL6_C register description
18-Sep-2020	5	Updated Table 38. Accelerometer ODR selection Updated description of BDR_XL_[3:0] in FIFO_CTRL3 (09h), adding 1.6 Hz Updated description of ODR_T_BATCH_[1:0] in FIFO_CTRL4 (0Ah), adding 1.6 Hz

Contents

1	Overview	3
2	Embedded low-power features	4
2.1	Finite State Machine	5
2.2	Machine Learning Core	6
3	Pin description	7
3.1	Pin connections	7
4	Module specifications	9
4.1	Mechanical characteristics	9
4.2	Electrical characteristics	10
4.3	Temperature sensor characteristics	10
4.4	Communication interface characteristics	11
4.4.1	SPI - serial peripheral interface	11
4.4.2	I ² C - inter-IC control interface	12
4.5	Absolute maximum ratings	13
5	Digital interfaces	14
5.1	I ² C/SPI interface	14
5.2	I ² C serial interface	14
5.2.1	I ² C operation	15
5.3	SPI bus interface	17
5.3.1	SPI read	18
5.3.2	SPI write	19
5.3.3	SPI read in 3-wire mode	19
5.4	Master I ² C interface	20
6	Functionality	21
6.1	Block diagram of filters	21
6.1.1	Block diagrams of the accelerometer filters	21
6.2	FIFO	23
6.2.1	Bypass mode	23
6.2.2	FIFO mode	23

6.2.3	Continuous mode	24
6.2.4	Continuous-to-FIFO mode.....	24
6.2.5	Bypass-to-Continuous mode.....	24
6.2.6	Bypass-to-FIFO mode.....	24
6.2.7	FIFO reading procedure	24
7	Frequency response	25
8	Typical performance characteristics	26
8.1	Frequency response measurements	26
9	Application hints	28
9.1	IIS2ICLX electrical connections in Mode 1.....	28
9.2	IIS2ICLX electrical connections in Mode 2.....	29
10	Register map	31
11	Register description	33
11.1	FUNC_CFG_ACCESS (01h).....	33
11.2	PIN_CTRL (02h)	33
11.3	FIFO_CTRL1 (07h).....	34
11.4	FIFO_CTRL2 (08h).....	34
11.5	FIFO_CTRL3 (09h).....	35
11.6	FIFO_CTRL4 (0Ah).....	36
11.7	COUNTER_BDR_REG1 (0Bh)	37
11.8	COUNTER_BDR_REG2 (0Ch).....	37
11.9	INT1_CTRL (0Dh).....	38
11.10	INT2_CTRL (0Eh)	38
11.11	WHO_AM_I (0Fh)	38
11.12	CTRL1_XL (10h).....	39
11.13	CTRL3_C (12h).....	40
11.14	CTRL4_C (13h).....	41
11.15	CTRL5_C (14h).....	41
11.16	CTRL6_C (15h).....	42
11.17	CTRL7_XL (16h).....	42

11.18	CTRL8_XL (17h).....	43
11.19	CTRL9_XL (18h).....	44
11.20	CTRL10_C (19h).....	44
11.21	ALL_INT_SRC (1Ah)	45
11.22	WAKE_UP_SRC (1Bh).....	45
11.23	TAP_SRC (1Ch)	46
11.24	DEN_SRC (1Dh).....	46
11.25	STATUS_REG (1Eh).....	47
11.26	OUT_TEMP_L (20h), OUT_TEMP_H (21h).....	47
11.27	OUTX_L_A (28h) and OUTX_H_A (29h)	48
11.28	OUTY_L_A (2Ah) and OUTY_H_A (2Bh)	48
11.29	EMB_FUNC_STATUS_MAINPAGE (35h)	48
11.30	FSM_STATUS_A_MAINPAGE (36h)	49
11.31	FSM_STATUS_B_MAINPAGE (37h)	49
11.32	MLC_STATUS_MAINPAGE (38h).....	50
11.33	STATUS_MASTER_MAINPAGE (39h).....	50
11.34	FIFO_STATUS1 (3Ah)	51
11.35	FIFO_STATUS2 (3Bh)	51
11.36	TIMESTAMP0 (40h), TIMESTAMP1 (41h), TIMESTAMP2 (42h), and TIMESTAMP3 (43h)	52
11.37	TAP_CFG0 (56h).....	53
11.38	TAP_CFG1 (57h).....	53
11.39	TAP_CFG2 (58h).....	54
11.40	INT_DUR2 (5Ah).....	54
11.41	WAKE_UP_THS (5Bh).....	55
11.42	WAKE_UP_DUR (5Ch)	55
11.43	MD1_CFG (5Eh)	56
11.44	MD2_CFG (5Fh)	57
11.45	INTERNAL_FREQ_FINE (63h).....	58
11.46	X_OFS_USR (73h).....	59
11.47	Y_OFS_USR (74h).....	59

11.48	FIFO_DATA_OUT_TAG (78h)	60
11.49	FIFO_DATA_OUT_X_L (79h) and FIFO_DATA_OUT_X_H (7Ah)	61
11.50	FIFO_DATA_OUT_Y_L (7Bh) and FIFO_DATA_OUT_Y_H (7Ch)	61
11.51	FIFO_DATA_OUT_Z_L (7Dh) and FIFO_DATA_OUT_Z_H (7Eh)	61
12	Embedded functions register map	62
13	Embedded functions register description	64
13.1	PAGE_SEL (02h)	64
13.2	EMB_FUNC_EN_B (05h)	64
13.3	PAGE_ADDRESS (08h)	64
13.4	PAGE_VALUE (09h)	65
13.5	EMB_FUNC_INT1 (0Ah)	65
13.6	FSM_INT1_A (0Bh)	66
13.7	FSM_INT1_B (0Ch)	67
13.8	MLC_INT1 (0Dh)	68
13.9	EMB_FUNC_INT2 (0Eh)	68
13.10	FSM_INT2_A (0Fh)	69
13.11	FSM_INT2_B (10h)	70
13.12	MLC_INT2 (11h)	71
13.13	EMB_FUNC_STATUS (12h)	71
13.14	FSM_STATUS_A (13h)	72
13.15	FSM_STATUS_B (14h)	72
13.16	MLC_STATUS (15h)	73
13.17	PAGE_RW (17h)	73
13.18	FSM_ENABLE_A (46h)	74
13.19	FSM_ENABLE_B (47h)	74
13.20	FSM_LONG_COUNTER_L (48h) and FSM_LONG_COUNTER_H (49h)	75
13.21	FSM_LONG_COUNTER_CLEAR (4Ah)	75
13.22	FSM_OUTS1 (4Ch)	76
13.23	FSM_OUTS2 (4Dh)	76
13.24	FSM_OUTS3 (4Eh)	77

13.25	FSM_OUTS4 (4Fh).....	77
13.26	FSM_OUTS5 (50h).....	78
13.27	FSM_OUTS6 (51h).....	78
13.28	FSM_OUTS7 (52h).....	79
13.29	FSM_OUTS8 (53h).....	79
13.30	FSM_OUTS9 (54h).....	80
13.31	FSM_OUTS10 (55h).....	80
13.32	FSM_OUTS11 (56h).....	81
13.33	FSM_OUTS12 (57h).....	81
13.34	FSM_OUTS13 (58h).....	82
13.35	FSM_OUTS14 (59h).....	82
13.36	FSM_OUTS15 (5Ah).....	83
13.37	FSM_OUTS16 (5Bh).....	83
13.38	EMB_FUNC_ODR_CFG_B (5Fh).....	84
13.39	EMB_FUNC_ODR_CFG_C (60h).....	84
13.40	EMB_FUNC_INIT_B (67h).....	84
13.41	MLC0_SRC (70h).....	85
13.42	MLC1_SRC (71h).....	85
13.43	MLC2_SRC (72h).....	85
13.44	MLC3_SRC (73h).....	85
13.45	MLC4_SRC (74h).....	86
13.46	MLC5_SRC (75h).....	86
13.47	MLC6_SRC (76h).....	86
13.48	MLC7_SRC (77h).....	86
14	Embedded advanced features.....	87
15	Embedded advanced features register description.....	89
15.1	Page 1 - Embedded advanced features registers.....	89
15.1.1	FSM_LC_TIMEOUT_L (7Ah) and FSM_LC_TIMEOUT_H (7Bh).....	89
15.1.2	FSM_PROGRAMS (7Ch).....	89
15.1.3	FSM_START_ADD_L (7Eh) and FSM_START_ADD_H (7Fh).....	90

16	Sensor hub register map	.91
17	Sensor hub register description	.93
17.1	SENSOR_HUB_1 (02h)	93
17.2	SENSOR_HUB_2 (03h)	93
17.3	SENSOR_HUB_3 (04h)	93
17.4	SENSOR_HUB_4 (05h)	94
17.5	SENSOR_HUB_5 (06h)	94
17.6	SENSOR_HUB_6 (07h)	94
17.7	SENSOR_HUB_7 (08h)	95
17.8	SENSOR_HUB_8 (09h)	95
17.9	SENSOR_HUB_9 (0Ah)	95
17.10	SENSOR_HUB_10 (0Bh)	96
17.11	SENSOR_HUB_11 (0Ch)	96
17.12	SENSOR_HUB_12 (0Dh)	96
17.13	SENSOR_HUB_13 (0Eh)	97
17.14	SENSOR_HUB_14 (0Fh)	97
17.15	SENSOR_HUB_15 (10h)	97
17.16	SENSOR_HUB_16 (11h)	98
17.17	SENSOR_HUB_17 (12h)	98
17.18	SENSOR_HUB_18 (13h)	98
17.19	MASTER_CONFIG (14h)	99
17.20	SLV0_ADD (15h)	99
17.21	SLV0_SUBADD (16h)	100
17.22	SLAVE0_CONFIG (17h)	100
17.23	SLV1_ADD (18h)	100
17.24	SLV1_SUBADD (19h)	101
17.25	SLAVE1_CONFIG (1Ah)	101
17.26	SLV2_ADD (1Bh)	101
17.27	SLV2_SUBADD (1Ch)	102
17.28	SLAVE2_CONFIG (1Dh)	102

17.29	SLV3_ADD (1Eh)	102
17.30	SLV3_SUBADD (1Fh).....	103
17.31	SLAVE3_CONFIG (20h).....	103
17.32	DATAWRITE_SLV0 (21h).....	103
17.33	STATUS_MASTER (22h).....	104
18	Soldering information.....	105
19	Package information.....	106
19.1	LGA-16L package information.....	106
	Revision history	107
	Contents	108
	List of tables	115
	List of figures.....	121

List of tables

Table 1.	Pin description	8
Table 2.	Mechanical characteristics	9
Table 3.	Electrical characteristics	10
Table 4.	Temperature sensor characteristics	10
Table 5.	SPI slave timing values (in mode 3)	11
Table 6.	I ² C slave timing values	12
Table 7.	Absolute maximum ratings	13
Table 8.	Serial interface pin description	14
Table 9.	I ² C terminology	14
Table 10.	SAD+Read/Write patterns	15
Table 11.	Transfer when master is writing one byte to slave	15
Table 12.	Transfer when master is writing multiple bytes to slave	15
Table 13.	Transfer when master is receiving (reading) one byte of data from slave	15
Table 14.	Transfer when master is receiving (reading) multiple bytes of data from slave	15
Table 15.	Master I ² C pin details	20
Table 16.	Internal pin status	30
Table 17.	Registers address map	31
Table 18.	FUNC_CFG_ACCESS register	33
Table 19.	FUNC_CFG_ACCESS register description	33
Table 20.	PIN_CTRL register	33
Table 21.	PIN_CTRL register description	33
Table 22.	FIFO_CTRL1 register	34
Table 23.	FIFO_CTRL1 register description	34
Table 24.	FIFO_CTRL2 register	34
Table 25.	FIFO_CTRL2 register	34
Table 26.	FIFO_CTRL3 register	35
Table 27.	FIFO_CTRL3 register description	35
Table 28.	FIFO_CTRL4 register	36
Table 29.	FIFO_CTRL4 register description	36
Table 30.	COUNTER_BDR_REG1 register	37
Table 31.	COUNTER_BDR_REG1 register description	37
Table 32.	COUNTER_BDR_REG2 register description	37
Table 33.	INT1_CTRL register description	38
Table 34.	INT2_CTRL register	38
Table 35.	INT2_CTRL register description	38
Table 36.	Who_Am_I register	38
Table 37.	CTRL1_XL register description	39
Table 38.	Accelerometer ODR selection	39
Table 39.	Accelerometer full-scale selection	39
Table 40.	CTRL3_C register	40
Table 41.	CTRL3_C register description	40
Table 42.	CTRL4_C register	41
Table 43.	CTRL4_C register description	41
Table 44.	CTRL5_C register	41
Table 45.	CTRL5_C register description	41
Table 46.	Linear acceleration sensor self-test mode selection	41
Table 47.	CTRL6_C register	42
Table 48.	CTRL6_C register description	42
Table 49.	Trigger mode selection	42
Table 50.	CTRL7_XL register	42
Table 51.	CTRL7_XL register description	42
Table 52.	CTRL8_XL register	43

Table 53.	Accelerometer bandwidth configurations	43
Table 54.	CTRL9_XL register	44
Table 55.	CTRL9_XL register description	44
Table 56.	CTRL10_C register	44
Table 57.	CTRL10_C register description	44
Table 58.	ALL_INT_SRC register	45
Table 59.	ALL_INT_SRC register description	45
Table 60.	WAKE_UP_SRC register	45
Table 61.	WAKE_UP_SRC register description	45
Table 62.	TAP_SRC register	46
Table 63.	TAP_SRC register description	46
Table 64.	DEN_SRC register	46
Table 65.	DEN_SRC register description	46
Table 66.	STATUS_REG register	47
Table 67.	STATUS_REG register description	47
Table 68.	OUT_TEMP_L register	47
Table 69.	OUT_TEMP_H register	47
Table 70.	OUT_TEMP register description	47
Table 71.	OUTX_L_A register	48
Table 72.	OUTX_H_A register	48
Table 73.	OUTX_H_A register description	48
Table 74.	OUTY_L_A register	48
Table 75.	OUTY_H_A register	48
Table 76.	OUTY_H_A register description	48
Table 77.	EMB_FUNC_STATUS_MAINPAGE register	48
Table 78.	EMB_FUNC_STATUS_MAINPAGE register description	48
Table 79.	FSM_STATUS_A_MAINPAGE register	49
Table 80.	FSM_STATUS_A_MAINPAGE register description	49
Table 81.	FSM_STATUS_B_MAINPAGE register	49
Table 82.	FSM_STATUS_B_MAINPAGE register description	49
Table 83.	MLC_STATUS_MAINPAGE register	50
Table 84.	MLC_STATUS_MAINPAGE register description	50
Table 85.	STATUS_MASTER_MAINPAGE register	50
Table 86.	STATUS_MASTER_MAINPAGE register description	50
Table 87.	FIFO_STATUS1 register	51
Table 88.	FIFO_STATUS1 register description	51
Table 89.	FIFO_STATUS2 register	51
Table 90.	FIFO_STATUS2 register description	51
Table 91.	TIMESTAMP output registers	52
Table 92.	TIMESTAMP output register description	52
Table 93.	TAP_CFG0 register	53
Table 94.	TAP_CFG0 register description	53
Table 95.	TAP_CFG1 register	53
Table 96.	TAP_CFG1 register description	53
Table 97.	TAP_CFG2 register	54
Table 98.	TAP_CFG2 register description	54
Table 99.	INT_DUR2 register	54
Table 100.	INT_DUR2 register description	54
Table 101.	WAKE_UP_THS register	55
Table 102.	WAKE_UP_THS register description	55
Table 103.	WAKE_UP_DUR register	55
Table 104.	WAKE_UP_DUR register description	55
Table 105.	MD1_CFG register	56
Table 106.	MD1_CFG register description	56

Table 107.	MD2_CFG register	57
Table 108.	MD2_CFG register description	57
Table 109.	INTERNAL_FREQ_FINE register	58
Table 110.	INTERNAL_FREQ_FINE register description	58
Table 111.	X_OFS_USR register	59
Table 112.	X_OFS_USR register description	59
Table 113.	Y_OFS_USR register	59
Table 114.	Y_OFS_USR register description	59
Table 115.	FIFO_DATA_OUT_TAG register	60
Table 116.	FIFO_DATA_OUT_TAG register description	60
Table 117.	FIFO tag	60
Table 118.	FIFO_DATA_OUT_X_H and FIFO_DATA_OUT_X_L registers	61
Table 119.	FIFO_DATA_OUT_X_H and FIFO_DATA_OUT_X_L register description	61
Table 120.	FIFO_DATA_OUT_Y_H and FIFO_DATA_OUT_Y_L registers	61
Table 121.	FIFO_DATA_OUT_Y_H and FIFO_DATA_OUT_Y_L register description	61
Table 122.	FIFO_DATA_OUT_Z_H and FIFO_DATA_OUT_Z_L registers	61
Table 123.	FIFO_DATA_OUT_Z_H and FIFO_DATA_OUT_Z_L register description	61
Table 124.	Register address map - embedded functions	62
Table 125.	PAGE_SEL register	64
Table 126.	PAGE_SEL register description	64
Table 127.	EMB_FUNC_EN_B register	64
Table 128.	EMB_FUNC_EN_B register description	64
Table 129.	PAGE_ADDRESS register	64
Table 130.	PAGE_ADDRESS register description	64
Table 131.	PAGE_VALUE register	65
Table 132.	PAGE_VALUE register description	65
Table 133.	EMB_FUNC_INT1 register	65
Table 134.	EMB_FUNC_INT1 register description	65
Table 135.	FSM_INT1_A register	66
Table 136.	FSM_INT1_A register description	66
Table 137.	FSM_INT1_B register	67
Table 138.	FSM_INT1_B register description	67
Table 139.	MLC_INT1 register	68
Table 140.	MLC_INT1 register description	68
Table 141.	EMB_FUNC_INT2 register	68
Table 142.	EMB_FUNC_INT2 register description	68
Table 143.	FSM_INT2_A register	69
Table 144.	FSM_INT2_A register description	69
Table 145.	FSM_INT2_B register	70
Table 146.	FSM_INT2_B register description	70
Table 147.	MLC_INT2 register	71
Table 148.	MLC_INT2 register description	71
Table 149.	EMB_FUNC_STATUS register	71
Table 150.	EMB_FUNC_STATUS register description	71
Table 151.	FSM_STATUS_A register	72
Table 152.	FSM_STATUS_A register description	72
Table 153.	FSM_STATUS_B register	72
Table 154.	FSM_STATUS_B register description	72
Table 155.	MLC_STATUS register	73
Table 156.	MLC_STATUS register description	73
Table 157.	PAGE_RW register	73
Table 158.	PAGE_RW register description	73
Table 159.	FSM_ENABLE_A register	74
Table 160.	FSM_ENABLE_A register description	74

Table 161.	FSM_ENABLE_B register	74
Table 162.	FSM_ENABLE_B register description	74
Table 163.	FSM_LONG_COUNTER_L register	75
Table 164.	FSM_LONG_COUNTER_L register description	75
Table 165.	FSM_LONG_COUNTER_H register	75
Table 166.	FSM_LONG_COUNTER_H register description	75
Table 167.	FSM_LONG_COUNTER_CLEAR register	75
Table 168.	FSM_LONG_COUNTER_CLEAR register description	75
Table 169.	FSM_OUTS1 register	76
Table 170.	FSM_OUTS1 register description	76
Table 171.	FSM_OUTS2 register	76
Table 172.	FSM_OUTS2 register description	76
Table 173.	FSM_OUTS3 register	77
Table 174.	FSM_OUTS3 register description	77
Table 175.	FSM_OUTS4 register	77
Table 176.	FSM_OUTS4 register description	77
Table 177.	FSM_OUTS5 register	78
Table 178.	FSM_OUTS5 register description	78
Table 179.	FSM_OUTS6 register	78
Table 180.	FSM_OUTS6 register description	78
Table 181.	FSM_OUTS7 register	79
Table 182.	FSM_OUTS7 register description	79
Table 183.	FSM_OUTS8 register	79
Table 184.	FSM_OUTS8 register description	79
Table 185.	FSM_OUTS9 register	80
Table 186.	FSM_OUTS9 register description	80
Table 187.	FSM_OUTS10 register	80
Table 188.	FSM_OUTS10 register description	80
Table 189.	FSM_OUTS11 register	81
Table 190.	FSM_OUTS11 register description	81
Table 191.	FSM_OUTS12 register	81
Table 192.	FSM_OUTS12 register description	81
Table 193.	FSM_OUTS13 register	82
Table 194.	FSM_OUTS13 register description	82
Table 195.	FSM_OUTS14 register	82
Table 196.	FSM_OUTS14 register description	82
Table 197.	FSM_OUTS15 register	83
Table 198.	FSM_OUTS15 register description	83
Table 199.	FSM_OUTS16 register	83
Table 200.	FSM_OUTS16 register description	83
Table 201.	EMB_FUNC_ODR_CFG_B register	84
Table 202.	EMB_FUNC_ODR_CFG_B register description	84
Table 203.	EMB_FUNC_ODR_CFG_C register	84
Table 204.	EMB_FUNC_ODR_CFG_C register description	84
Table 205.	EMB_FUNC_INIT_B register	84
Table 206.	EMB_FUNC_INIT_B register description	84
Table 207.	MLC0_SRC register	85
Table 208.	MLC0_SRC register description	85
Table 209.	MLC1_SRC register	85
Table 210.	MLC1_SRC register description	85
Table 211.	MLC2_SRC register	85
Table 212.	MLC2_SRC register description	85
Table 213.	MLC3_SRC register	85
Table 214.	MLC3_SRC register description	85

Table 215. MLC4_SRC register	86
Table 216. MLC4_SRC register description	86
Table 217. MLC5_SRC register	86
Table 218. MLC5_SRC register description	86
Table 219. MLC6_SRC register	86
Table 220. MLC6_SRC register description	86
Table 221. MLC7_SRC register	86
Table 222. MLC7_SRC register description	86
Table 223. Register address map - embedded advanced features page 1	87
Table 224. FSM_LC_TIMEOUT_L register	89
Table 225. FSM_LC_TIMEOUT_L register description	89
Table 226. FSM_LC_TIMEOUT_H register	89
Table 227. FSM_LC_TIMEOUT_H register description	89
Table 228. FSM_PROGRAMS register	89
Table 229. FSM_PROGRAMS register description	89
Table 230. FSM_START_ADD_L register	90
Table 231. FSM_START_ADD_L register description	90
Table 232. FSM_START_ADD_H register	90
Table 233. FSM_START_ADD_H register description	90
Table 234. Registers address map	91
Table 235. SENSOR_HUB_1 register	93
Table 236. SENSOR_HUB_1 register description	93
Table 237. SENSOR_HUB_2 register	93
Table 238. SENSOR_HUB_2 register description	93
Table 239. SENSOR_HUB_3 register	93
Table 240. SENSOR_HUB_3 register description	93
Table 241. SENSOR_HUB_4 register	94
Table 242. SENSOR_HUB_4 register description	94
Table 243. SENSOR_HUB_5 register	94
Table 244. SENSOR_HUB_5 register description	94
Table 245. SENSOR_HUB_6 register	94
Table 246. SENSOR_HUB_6 register description	94
Table 247. SENSOR_HUB_7 register	95
Table 248. SENSOR_HUB_7 register description	95
Table 249. SENSOR_HUB_8 register	95
Table 250. SENSOR_HUB_8 register description	95
Table 251. SENSOR_HUB_9 register	95
Table 252. SENSOR_HUB_9 register description	95
Table 253. SENSOR_HUB_10 register	96
Table 254. SENSOR_HUB_10 register description	96
Table 255. SENSOR_HUB_11 register	96
Table 256. SENSOR_HUB_11 register description	96
Table 257. SENSOR_HUB_12 register	96
Table 258. SENSOR_HUB_12 register description	96
Table 259. SENSOR_HUB_13 register	97
Table 260. SENSOR_HUB_13 register description	97
Table 261. SENSOR_HUB_14 register	97
Table 262. SENSOR_HUB_14 register description	97
Table 263. SENSOR_HUB_15 register	97
Table 264. SENSOR_HUB_15 register description	97
Table 265. SENSOR_HUB_16 register	98
Table 266. SENSOR_HUB_16 register description	98
Table 267. SENSOR_HUB_17 register	98
Table 268. SENSOR_HUB_17 register description	98

Table 269.	SENSOR_HUB_18 register	98
Table 270.	SENSOR_HUB_18 register description	98
Table 271.	MASTER_CONFIG register	99
Table 272.	MASTER_CONFIG register description	99
Table 273.	SLV0_ADD register	99
Table 274.	SLV0_ADD register description	99
Table 275.	SLV0_SUBADD register	100
Table 276.	SLV0_SUBADD register description	100
Table 277.	SLAVE0_CONFIG register	100
Table 278.	SLAVE0_CONFIG register description	100
Table 279.	SLV1_ADD register	100
Table 280.	SLV1_ADD register description	100
Table 281.	SLV1_SUBADD register	101
Table 282.	SLV1_SUBADD register description	101
Table 283.	SLAVE1_CONFIG register	101
Table 284.	SLAVE1_CONFIG register description	101
Table 285.	SLV2_ADD register	101
Table 286.	SLV2_ADD register description	101
Table 287.	SLV2_SUBADD register	102
Table 288.	SLV2_SUBADD register description	102
Table 289.	SLAVE2_CONFIG register	102
Table 290.	SLAVE2_CONFIG register description	102
Table 291.	SLV3_ADD register	102
Table 292.	SLV3_ADD register description	102
Table 293.	SLV3_SUBADD register	103
Table 294.	SLV3_SUBADD register description	103
Table 295.	SLAVE3_CONFIG register	103
Table 296.	SLAVE3_CONFIG register description	103
Table 297.	DATAWRITE_SLV0 register	103
Table 298.	DATAWRITE_SLV0 register description	103
Table 299.	STATUS_MASTER register	104
Table 300.	STATUS_MASTER register description	104
Table 301.	Outer dimensions	106
Table 302.	Document revision history	107

List of figures

Figure 1.	Generic state machine	5
Figure 2.	State machine in the IIS2ICLX	5
Figure 3.	Machine Learning Core in the IIS2ICLX	6
Figure 4.	Pin connections	7
Figure 5.	IIS2ICLX connection modes	7
Figure 6.	SPI slave timing diagram (in mode 3)	11
Figure 7.	I ² C slave timing diagram	12
Figure 8.	Read and write protocol (in mode 3)	17
Figure 9.	SPI read protocol (in mode 3)	18
Figure 10.	Multiple byte SPI read protocol (2-byte example) (in mode 3)	18
Figure 11.	SPI write protocol (in mode 3)	19
Figure 12.	Multiple byte SPI write protocol (2-byte example) (in mode 3)	19
Figure 13.	SPI read protocol in 3-wire mode (in mode 3)	19
Figure 14.	Block diagram of filters	21
Figure 15.	Accelerometer UI chain	21
Figure 16.	Accelerometer composite filter	22
Figure 17.	Filtering chain.	25
Figure 18.	Frequency response at the output of LPF1 filter at different ODR configurations	25
Figure 19.	Frequency response- X-axis ODR = 833 Hz, BW = ODR/2	26
Figure 20.	Frequency response - Y-axis ODR = 833 Hz, BW = ODR/2	26
Figure 21.	Frequency response - X-axis ODR = 104 Hz, BW = ODR/2	26
Figure 22.	Frequency response - Y-axis ODR = 104 Hz, BW = ODR/2	27
Figure 23.	Frequency response - X-axis ODR = 12.5 Hz, BW = ODR/2	27
Figure 24.	Frequency response - Y-axis ODR = 12.5 Hz, BW = ODR/2	27
Figure 25.	IIS2ICLX electrical connections in Mode 1	28
Figure 26.	IIS2ICLX electrical connections in Mode 2	29
Figure 27.	Ceramic cavity LGA-16: package outline and mechanical data	106