

BACnet Server

M-Bus Meters

USER MANUAL

Issue date 11/2020 r1.6 ENGLISH

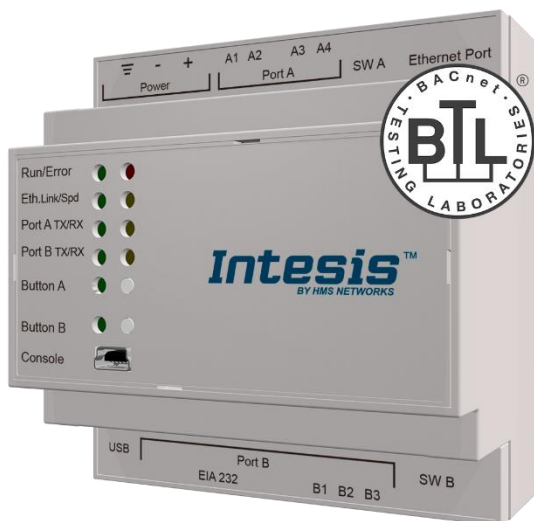

Important User Information

Disclaimer

The information in this document is for informational purposes only. Please inform HMS Industrial Networks of any inaccuracies or omissions found in this document. HMS Industrial Networks disclaims any responsibility or liability for any errors that may appear in this document.

HMS Industrial Networks reserves the right to modify its products in line with its policy of continuous product development. The information in this document shall therefore not be construed as a commitment on the part of HMS Industrial Networks and is subject to change without notice. HMS Industrial Networks makes no commitment to update or keep current the information in this document.

The data, examples and illustrations found in this document are included for illustrative purposes and are only intended to help improve understanding of the functionality and handling of the product. In view of the wide range of possible applications of the product, and because of the many variables and requirements associated with any particular implementation, HMS Industrial Networks cannot assume responsibility or liability for actual use based on the data, examples or illustrations included in this document nor for any damages incurred during installation of the product. Those responsible for the use of the product must acquire sufficient knowledge in order to ensure that the product is used correctly in their specific application and that the application meets all performance and safety requirements including any applicable laws, regulations, codes and standards. Further, HMS Industrial Networks will under no circumstances assume liability or responsibility for any problems that may arise as a result from the use of undocumented features or functional side effects found outside the documented scope of the product. The effects caused by any direct or indirect use of such aspects of the product are undefined and may include e.g. compatibility issues and stability issues.

Gateway for the integration of M-Bus devices into BACnet MSTP or BACnet IP enabled monitoring and control systems.

ORDER CODE	LEGACY ORDER CODE
INBACMEB0100000	IBBACMEB0100000
INBACMEB0200000	IBBACMEB0200000
INBACMEB0600000	IBBACMEB0600000
INBACMEB1200000	IBBACMEB1200000

INDEX

1	Description	5
1.1	Introduction	5
1.2	Functionality	6
1.3	Gateway's capacity	7
2	Protocol Implementation Conformance Statement	8
2.1	BACnet Standardized Device Profile (Annex L):	8
2.2	Segmentation Capability:	8
2.3	Data Link Layer Options:	8
2.4	Device Address Binding:	9
2.5	Networking Options:	9
2.6	Character Sets Supported	9
2.7	Gateway	9
3	BACnet Interoperability Building Blocks Supported (BIBBs)	10
3.1	Data Sharing BIBBs	10
3.2	Alarm and Event Management BIBBs	10
3.3	Scheduling BIBBs	11
3.4	Trending BIBBs	11
3.5	Network Management BIBBs	11
3.6	Device Management BIBBs	12
4	Service Types	13
5	Objects	14
5.1	Supported Object Types	14
5.2	Objects and properties	15
5.2.1	INBACMEB---0000 (Device Object Type)	15
5.2.2	Analog Input Object Type	17
5.2.3	Analog Output Object Type	18
5.2.4	Analog Value Object Type	19
5.2.5	Binary Input Object Type	20
5.2.6	Binary Output Object Type	21
5.2.7	Binary Value Object Type	22
5.2.8	Multistate Input Object Type	23
5.2.9	Multistate Output Object Type	24
5.2.10	Multistate Value Object Type	25
5.2.11	Calendar Object Type	26
5.2.12	Schedule Object Type	27
5.2.13	Notification Class Object Type	28
5.2.14	Trend Log Object Type	29
5.2.15	Trend Log Multiple Object Type	30
6	Connections	31
6.1	Powering the device	32
6.2	Connection to BACnet	32
6.2.1	BACnet IP	32
6.2.2	BACnet MSTP	32
6.3	Connection to M-Bus	33
6.4	Connection to the configuration tool	33
7	Set-up process and troubleshooting	34
7.1	Pre-requisites	34
7.2	Intesis MAPS. Configuration & monitoring tool for Intesis BACnet series	34
7.2.1	Introduction	34
7.2.2	Connection	34
7.2.3	Configuration tab	35
7.2.4	Signals	35
7.2.5	Sending the configuration to Intesis	36
7.2.6	Diagnostic	36
7.3	Set-up procedure	38
8	Electrical & Mechanical Features	39
9	Dimensions	40

Description

1.1 Introduction

This document describes the integration of M-Bus meters with BACnet ASHRAE 135 – 2001 Annex J - BACnet protocol compatible devices or systems using the gateway Intesis BACnet/IP Server - M-Bus.

The aim of this integration is to make accessible M-Bus devices signals and resources from a BACnet based control system or device, as if it was a part of the own BACnet system and vice-versa.

The gateway acts as a BACnet/IP Server or BACnet MSTP device in its BACnet interface, allowing other BACnet devices to perform subscription (COV) requests and reads/writes to its internal points. From the M-Bus point of view, Intesis acts as a M-Bus master device (EN-1434-3), the readings of the M-Bus slave device(s) are performed by Intesis by automatic continuous polling.

Intesis incorporates an embedded M-Bus level converter, so no extra hardware is required.

Configuration is carried out using the configuration software Intesis™ MAPS.

This document assumes that the user is familiar with BACnet and M-Bus technologies and their technical terms.

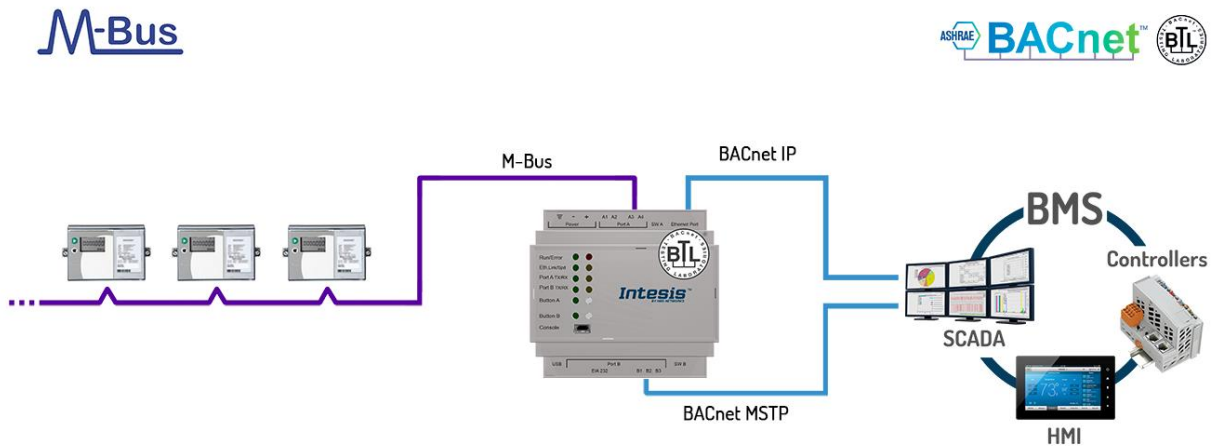

Integration of MBUS devices to BACnet IP or MSTP control and monitoring systems

1.2 *Functionality*

Intesis polls, either continuously or only when ordered from the BACnet side, the M-Bus devices to obtain updated readings for the points configured in it (the points corresponding to measures and states of the meters in the integration points list explained later in this document). With every read, the new values received are updated in the Intesis memory and become available in the BACnet side. When a change in any point configured as output in Intesis is detected (this is written from the BACnet side), the corresponding action in the M-Bus device will be performed. These actions can be to force a polling of a specific M-Bus device or to force a polling of all M-Bus devices.

The polling of a specific M-Bus device, or of all M-Bus devices, can be forced in any moment from BACnet side by writing a 1 in the corresponding binary point specially enabled for this purpose in the Intesis.

The automatic continuous polling of all M-Bus devices can be activated/deactivated writing from BACnet in a specific binary point specially enabled for this purpose in the Intesis.

Other M-Bus information accessible from BACnet, using specific points of the Intesis, is:

- Bus activity (indicates if meters are currently being polled or if polling is in stand-by).
- M-Bus status of every meter (this M-Bus status is sent by the own meter with every poll and indicates the internal status, manufacturer specific in every case).

These are the main features of the M-Bus interface of Intesis:

- Embedded level converter. Direct connection to M-Bus devices with no extra hardware required.
- Scan option to automatically detect M-Bus devices and its available registers.
- Import/Export of M-Bus device templates.
- EIA485 two wires (plug-in terminal bloc with screws) connection.
- Baud rate configurable from 300 to 9600 bps (allowed baud rates in M-Bus. The devices are normally configured at 2400 bps at the factory).
- Primary or secondary addressing allowed.
- Useful timeouts and specific parameters to make the interface widely compatible with many meter's peculiarities found usually between different manufacturers.
- Polling of the meters can be continuously, either configured in the own Intesis or you can activate/deactivate continuous polling of the meters from BACnet side using a special datapoint.
- You can force a polling of the meters (refresh of readings) in any moment from BACnet side using special datapoints: one datapoint to force a polling of all the meters, and one specific datapoint per meter to force the polling of the individual meter.
- Intesis can also be configured to make a single polling of the meters (refresh of readings) at the start up.
- For each meter, a datapoint is available in BACnet indicating communication error with the meter, also a general communication error datapoint is available (that will be active whenever the communication with one or more meters has failed).
- Fully flexible configuration of the registers to poll in the meter, to adapt to any meter.

Every meter, depending on manufacturer and model, offers different type of signals from the mentioned before. To know what signals offers the meter and of what type, to be able to integrate those wanted, refer to the device technical documentation. Anyway, and to ease and speed up the identification of the signals offered by any device (and of what type), the scan option is highly recommended or the import of templates too.

1.3 Gateway's capacity

Intesis capacity is listed below:

Element	10 version	20 version	60 version	120 version	Notes
Type of BACnet devices	IP / MSTP				Communication with BACnet IP and MSTP.
Number of BACnet Objects	250	500	1500	3000	Maximum number of points that can be defined in the virtual BACnet device inside the gateway.
Number of BACnet Subscriptions (COV) requests	500	1000	3000	6000	Maximum number of BACnet subscriptions (COV) requests accepted by the gateway.
Type of M-Bus devices	M-Bus EIA485 Slave devices				Those supporting M-Bus EN-1434-3 <i>standard</i> . Communication over RS485
Number of M-Bus slave devices	10	20	60	120	Number of M-Bus slave devices supported by the gateway.
Number of M-Bus signals	250	500	1500	3000	Number of M-Bus signals (readings in the meters) that can be read from Intesis.

2 Protocol Implementation Conformance Statement

BACnet Protocol Implementation Conformance Statement (PICS)

Date: 2017-09-18

Vendor Name: HMS Industrial Networks S.L.U

Product Name: INBACMEB---0000

Product Model Number: INBACMEB---0000

Application Software Version: 1.0

Firmware Revision: 1.0.0.0

BACnet Protocol Revision: 12

Product Description:

M-Bus – BACnet MS/TP & BACnet IP Gateway

Abstraction of M-Bus slave device registers as BACnet Objects.

2.1 BACnet Standardized Device Profile (Annex L):

- BACnet Operator Workstation (B-OWS)
- BACnet Building Controller (B-BC)
- BACnet Advanced Application Controller (B-AAC)
- BACnet Application Specific Controller (B-ASC)
- BACnet Smart Sensor (B-SS)
- BACnet Smart Actuator (B-SA)

Additional BACnet Interoperability Building Blocks Supported (Annex K):
Reference of BIBBs List

2.2 Segmentation Capability:

Segmented request supported	<input type="checkbox"/> No	<input checked="" type="checkbox"/> Yes	Window Size <u>16</u>
Segmented responses supported	<input type="checkbox"/> No	<input checked="" type="checkbox"/> Yes	Window Size <u>16</u>

2.3 Data Link Layer Options:

- BACnet IP, (Annex J)
- BACnet IP, (Annex J), Foreign Device
- ISO 8802-3, Ethernet (Clause 7)
- ANSI/ATA 878.1, 2.5 Mb. ARCNET (Clause 8)
- ANSI/ATA 878.1, RS-485 ARCNET (Clause 8), baud rate(s) _____
- MS/TP master (Clause 9), baud rate(s): 9600, 19200, 38400, 57600, 76800, 115200
- MS/TP slave (Clause 9), baud rate(s): _____
- Point-To-Point, EIA 232 (Clause 10), baud rate(s): _____
- Point-To-Point, modem, (Clause 10), baud rate(s): _____
- LonTalk, (Clause 11), medium: _____
- Other: _____

2.4 Device Address Binding:

Is static device binding supported? (This is currently necessary for two-way communication with MS/TP slaves and certain other devices.) Yes No

2.5 Networking Options:

- Router, Clause 6 - List all routing configurations, e.g., ARCNET-Ethernet, Ethernet-MS/TP, etc.
- Annex H, BACnet Tunneling Router over IP
- BACnet/IP Broadcast Management Device (BBMD)
Does the BBMD support registrations by Foreign Devices? Yes No

2.6 Character Sets Supported

Indicating support for multiple character sets does not imply that they can all be supported simultaneously.

- ISO 10646 (UTF-8)
- IBM™/Microsoft™ DBCS
- ISO 8859-1
- ISO 10646 (UCS-2)
- ISO 10646 (UCS-4)
- JIS X 0208

2.7 Gateway

If this product is a communication gateway, describe the types of non-BACnet equipment/network(s) that the gateway supports:

M-Bus slave devices.

3 BACnet Interoperability Building Blocks Supported (BIBBs)

3.1 Data Sharing BIBBs

BIBB Type		Active	BACnet Service	Initiate	Execute
DS-RP-A	Data Sharing-ReadProperty-A	<input type="checkbox"/>	ReadProperty	<input checked="" type="checkbox"/>	<input type="checkbox"/>
DS-RP-B	Data Sharing-ReadProperty-B	<input checked="" type="checkbox"/>	ReadProperty	<input type="checkbox"/>	<input checked="" type="checkbox"/>
DS-RPM-A	Data Sharing-ReadPropertyMultiple-A	<input type="checkbox"/>	ReadPropertyMultiple	<input checked="" type="checkbox"/>	<input type="checkbox"/>
DS-RPM-B	Data Sharing-ReadPropertyMultiple-B	<input checked="" type="checkbox"/>	ReadPropertyMultiple	<input type="checkbox"/>	<input checked="" type="checkbox"/>
DS-RPC-A	Data Sharing-ReadPropertyConditiona-A	<input type="checkbox"/>	ReadPropertyConditional	<input checked="" type="checkbox"/>	<input type="checkbox"/>
DS-RPC-B	Data Sharing-ReadPropertyConditional-B	<input type="checkbox"/>	ReadPropertyConditional	<input type="checkbox"/>	<input checked="" type="checkbox"/>
DS-WP-A	Data Sharing-WriteProperty-A	<input type="checkbox"/>	WriteProperty	<input checked="" type="checkbox"/>	<input type="checkbox"/>
DS-WP-B	Data Sharing-WriteProperty-B	<input checked="" type="checkbox"/>	WriteProperty	<input type="checkbox"/>	<input checked="" type="checkbox"/>
DS-WPM-A	Data Sharing-WritePropertyMultiple-A	<input type="checkbox"/>	WritePropertyMultiple	<input checked="" type="checkbox"/>	<input type="checkbox"/>
DS-WPM-B	Data Sharing-WritePropertyMultiple-B	<input checked="" type="checkbox"/>	WritePropertyMultiple	<input type="checkbox"/>	<input checked="" type="checkbox"/>
DS-COV-A	Data Sharing-COV-A	<input type="checkbox"/>	SubscribeCOV	<input checked="" type="checkbox"/>	<input type="checkbox"/>
		<input type="checkbox"/>	ConfirmedCOVNotification	<input type="checkbox"/>	<input checked="" type="checkbox"/>
		<input type="checkbox"/>	UnconfirmedCOVNotification	<input type="checkbox"/>	<input checked="" type="checkbox"/>
DS-COV-B	Data Sharing-COV-B	<input checked="" type="checkbox"/>	SubscribeCOV	<input type="checkbox"/>	<input checked="" type="checkbox"/>
		<input checked="" type="checkbox"/>	ConfirmedCOVNotification	<input checked="" type="checkbox"/>	<input type="checkbox"/>
		<input checked="" type="checkbox"/>	UnconfirmedCOVNotification	<input checked="" type="checkbox"/>	<input type="checkbox"/>
DS-COVP-A	Data Sharing-COVP-A	<input type="checkbox"/>	SubscribeCOVProperty	<input checked="" type="checkbox"/>	<input type="checkbox"/>
		<input type="checkbox"/>	ConfirmedCOVNotification	<input type="checkbox"/>	<input checked="" type="checkbox"/>
		<input type="checkbox"/>	UnconfirmedCOVNotification	<input type="checkbox"/>	<input checked="" type="checkbox"/>
DS-COVP-B	Data Sharing-COVP-B	<input type="checkbox"/>	SubscribeCOVProperty	<input type="checkbox"/>	<input checked="" type="checkbox"/>
		<input type="checkbox"/>	ConfirmedCOVNotification	<input checked="" type="checkbox"/>	<input type="checkbox"/>
		<input type="checkbox"/>	UnconfirmedCOVNotification	<input checked="" type="checkbox"/>	<input type="checkbox"/>
DS-COVU-A	Data Sharing-COV-Unsubscribed-A	<input type="checkbox"/>	UnconfirmedCOVNotification	<input type="checkbox"/>	<input checked="" type="checkbox"/>
DS-COVU-B	Data Sharing-COV-Unsubscribed-B	<input type="checkbox"/>	UnconfirmedCOVNotification	<input checked="" type="checkbox"/>	<input type="checkbox"/>

3.2 Alarm and Event Management BIBBs

BIBB Type		Active	BACnet Service	Initiate	Execute
AE-N-A	Alarm and Event-Notification-A	<input type="checkbox"/>	ConfirmedEventNotification	<input type="checkbox"/>	<input checked="" type="checkbox"/>
		<input type="checkbox"/>	UnconfirmedEventNotification	<input type="checkbox"/>	<input checked="" type="checkbox"/>
AE-N-I-B	Alarm and Event-Notification Internal-B	<input checked="" type="checkbox"/>	ConfirmedEventNotification	<input checked="" type="checkbox"/>	<input type="checkbox"/>
		<input checked="" type="checkbox"/>	UnconfirmedEventNotification	<input checked="" type="checkbox"/>	<input type="checkbox"/>
AE-N-E-B	Alarm and Event-Notification External-B	<input type="checkbox"/>	ConfirmedEventNotification	<input checked="" type="checkbox"/>	<input type="checkbox"/>
		<input type="checkbox"/>	UnconfirmedEventNotification	<input checked="" type="checkbox"/>	<input type="checkbox"/>
AE-ACK-A	Alarm and Event-ACK-A	<input type="checkbox"/>	AcknowledgeAlarm	<input checked="" type="checkbox"/>	<input type="checkbox"/>
AE-ACK-B	Alarm and Event-ACK-B	<input checked="" type="checkbox"/>	AcknowledgeAlarm	<input type="checkbox"/>	<input checked="" type="checkbox"/>
AE-ASUM-A	Alarm and Event-Alarm Summary-A	<input type="checkbox"/>	GetAlarmSummary	<input checked="" type="checkbox"/>	<input type="checkbox"/>
AE-ASUM-B	Alarm and Event-Alarm Summary-B	<input checked="" type="checkbox"/>	GetAlarmSummary	<input type="checkbox"/>	<input checked="" type="checkbox"/>
AE-ESUM-A	Alarm and Event-Enrollment Summary-A	<input type="checkbox"/>	GetEnrollmentSummary	<input checked="" type="checkbox"/>	<input type="checkbox"/>
AE-ESUM-B	Alarm and Event-Enrollment Summary-B	<input type="checkbox"/>	GetEnrollmentSummary	<input type="checkbox"/>	<input checked="" type="checkbox"/>
AE-INFO-A	Alarm and Event-Information-A	<input type="checkbox"/>	GetEventInformation	<input checked="" type="checkbox"/>	<input type="checkbox"/>
AE-INFO-B	Alarm and Event-Information-B	<input checked="" type="checkbox"/>	GetEventInformation	<input type="checkbox"/>	<input checked="" type="checkbox"/>
AE-LS-A	Alarm and Event-LifeSafety-A	<input type="checkbox"/>	LifeSafetyOperation	<input checked="" type="checkbox"/>	<input type="checkbox"/>
AE-LS-B	Alarm and Event-LifeSafety-B	<input type="checkbox"/>	LifeSafetyOperation	<input type="checkbox"/>	<input checked="" type="checkbox"/>

3.3 Scheduling BIBBs

BIBB Type		Active	BACnet Service	Initiate	Execute
SCHED-A	Scheduling–A <i>(must support DS-RP-A and DS-WP-A)</i>	<input type="checkbox"/>			
SCHED-I-B	Scheduling-Internal–B <i>(shall support DS-RP-B and DS-WP-B) (shall also support ether DM-TS-B or DS-UTC-B)</i>	<input checked="" type="checkbox"/>			
SCHED-E-B	Scheduling-External–B <i>(shall support SCHED-I-B and DS-WP-A)</i>	<input type="checkbox"/>			

3.4 Trending BIBBs

BIBB Type		Active	BACnet Service	Initiate	Execute
T-VMT-A	Trending - Viewing and Modifying Trends–A	<input type="checkbox"/>	ReadRange	<input checked="" type="checkbox"/>	<input type="checkbox"/>
T-VMT-I-B	Trending - Viewing and Modifying Trends Internal–B	<input checked="" type="checkbox"/>	ReadRange	<input type="checkbox"/>	<input checked="" type="checkbox"/>
T-VMT-E-B	Trending - Viewing and Modifying Trends External–B	<input type="checkbox"/>	ReadRange	<input type="checkbox"/>	<input checked="" type="checkbox"/>
T-ATR-A	Trending - Automated Trend Retrieval–A	<input type="checkbox"/>	ConfirmedEventNotification	<input type="checkbox"/>	<input checked="" type="checkbox"/>
		<input type="checkbox"/>	ReadRange	<input checked="" type="checkbox"/>	<input type="checkbox"/>
T-ATR-B	Trending - Automated Trend Retrieval–B	<input checked="" type="checkbox"/>	ConfirmedEventNotification	<input checked="" type="checkbox"/>	<input type="checkbox"/>
		<input checked="" type="checkbox"/>	ReadRange	<input type="checkbox"/>	<input checked="" type="checkbox"/>

3.5 Network Management BIBBs

BIBB Type		Active	BACnet Service	Initiate	Execute
NM-CE-A	Network Management - Connection Establishment–A	<input type="checkbox"/>	Establish-Connection-To-Network	<input checked="" type="checkbox"/>	<input type="checkbox"/>
		<input type="checkbox"/>	Disconnect-Connection-To-Network	<input checked="" type="checkbox"/>	<input type="checkbox"/>
NM-CE-B	Network Management - Connection Establishment– B	<input type="checkbox"/>	Establish-Connection-To-Network	<input type="checkbox"/>	<input checked="" type="checkbox"/>
		<input type="checkbox"/>	Disconnect-Connection-To-Network	<input type="checkbox"/>	<input checked="" type="checkbox"/>
NM-RC-A	Network Management - Router Configuration–A	<input type="checkbox"/>	Who-Is-Router-To-Network	<input checked="" type="checkbox"/>	<input type="checkbox"/>
		<input type="checkbox"/>	I-Am-Router-To-Network	<input type="checkbox"/>	<input checked="" type="checkbox"/>
		<input type="checkbox"/>	I-Could-Be-Router-To-Network	<input type="checkbox"/>	<input checked="" type="checkbox"/>
		<input type="checkbox"/>	Initialize-Routing-Table	<input checked="" type="checkbox"/>	<input type="checkbox"/>
		<input type="checkbox"/>	Initialize-Routing-Table-Ack	<input type="checkbox"/>	<input checked="" type="checkbox"/>
NM-RC-B	Network Management - Router Configuration–B	<input type="checkbox"/>	Who-Is-Router-To-Network	<input checked="" type="checkbox"/>	<input checked="" type="checkbox"/>
		<input type="checkbox"/>	I-Am-Router-To-Network	<input checked="" type="checkbox"/>	<input checked="" type="checkbox"/>
		<input type="checkbox"/>	Initialize-Routing-Table	<input type="checkbox"/>	<input checked="" type="checkbox"/>
		<input type="checkbox"/>	Initialize-Routing-Table-Ack	<input checked="" type="checkbox"/>	<input type="checkbox"/>

3.6 Device Management BIBBs

BIBB Type		Active	BACnet Service	Initiate	Execute
DM-DDB-A	Device Management - Dynamic Device Binding–A	<input checked="" type="checkbox"/>	Who-Is	<input checked="" type="checkbox"/>	<input type="checkbox"/>
		<input checked="" type="checkbox"/>	I-Am	<input type="checkbox"/>	<input checked="" type="checkbox"/>
DM-DDB-B	Device Management - Dynamic Device Binding–B	<input checked="" type="checkbox"/>	Who-Is	<input type="checkbox"/>	<input checked="" type="checkbox"/>
		<input checked="" type="checkbox"/>	I-Am	<input checked="" type="checkbox"/>	<input type="checkbox"/>
DM-DOB-A	Device Management - Dynamic Object Binding–A	<input type="checkbox"/>	Who-Has	<input checked="" type="checkbox"/>	<input type="checkbox"/>
		<input type="checkbox"/>	I-Have	<input type="checkbox"/>	<input checked="" type="checkbox"/>
DM-DOB-B	Device Management - Dynamic Object Binding–B	<input checked="" type="checkbox"/>	Who-Has	<input type="checkbox"/>	<input checked="" type="checkbox"/>
		<input checked="" type="checkbox"/>	I-Have	<input checked="" type="checkbox"/>	<input type="checkbox"/>
DM-DCC-A	Device Management - DeviceCommunicationControl–A	<input type="checkbox"/>	DeviceCommunicationControl	<input checked="" type="checkbox"/>	<input type="checkbox"/>
DM-DCC-B	Device Management - DeviceCommunicationControl–B	<input checked="" type="checkbox"/>	DeviceCommunicationControl	<input type="checkbox"/>	<input checked="" type="checkbox"/>
DM-PT-A	Device Management - PrivateTransfer–A	<input type="checkbox"/>	ConfirmedPrivateTransfer	<input checked="" type="checkbox"/>	<input type="checkbox"/>
		<input type="checkbox"/>	UnconfirmedPrivateTransfer	<input checked="" type="checkbox"/>	<input type="checkbox"/>
DM-PT-B	Device Management - PrivateTransfer–B	<input type="checkbox"/>	ConfirmedPrivateTransfer	<input type="checkbox"/>	<input checked="" type="checkbox"/>
		<input type="checkbox"/>	UnconfirmedPrivateTransfer	<input type="checkbox"/>	<input checked="" type="checkbox"/>
DM-TM-A	Device Management - Text Message–A	<input type="checkbox"/>	ConfirmedTextMessage	<input checked="" type="checkbox"/>	<input type="checkbox"/>
		<input type="checkbox"/>	UnconfirmedTextMessage	<input checked="" type="checkbox"/>	<input type="checkbox"/>
DM-TM-B	Device Management - Text Message–B	<input type="checkbox"/>	ConfirmedTextMessage	<input type="checkbox"/>	<input checked="" type="checkbox"/>
		<input type="checkbox"/>	UnconfirmedTextMessage	<input type="checkbox"/>	<input checked="" type="checkbox"/>
DM-TS-A	Device Management - TimeSynchronization–A	<input type="checkbox"/>	TimeSynchronization	<input checked="" type="checkbox"/>	<input type="checkbox"/>
DM-TS-B	Device Management - TimeSynchronization–B	<input checked="" type="checkbox"/>	TimeSynchronization	<input type="checkbox"/>	<input checked="" type="checkbox"/>
DM-UTC-A	Device Management - UTCTimeSynchronization–A	<input type="checkbox"/>	UTCTimeSynchronization	<input checked="" type="checkbox"/>	<input type="checkbox"/>
DM-UTC-B	Device Management - UTCTimeSynchronization–B	<input type="checkbox"/>	UTCTimeSynchronization	<input type="checkbox"/>	<input checked="" type="checkbox"/>
DM-RD-A	Device Management - ReinitializeDevice–A	<input type="checkbox"/>	ReinitializeDevice	<input checked="" type="checkbox"/>	<input type="checkbox"/>
DM-RD-B	Device Management - ReinitializeDevice–B	<input checked="" type="checkbox"/>	ReinitializeDevice	<input type="checkbox"/>	<input checked="" type="checkbox"/>
DM-BR-A	Device Management - Backup and Restore–A	<input type="checkbox"/>	AtomicReadFile	<input checked="" type="checkbox"/>	<input type="checkbox"/>
		<input type="checkbox"/>	AtomicWriteFile	<input checked="" type="checkbox"/>	<input type="checkbox"/>
		<input type="checkbox"/>	CreateObject	<input checked="" type="checkbox"/>	<input type="checkbox"/>
		<input type="checkbox"/>	ReinitializeDevice	<input checked="" type="checkbox"/>	<input type="checkbox"/>
DM-BR-B	Device Management - Backup and Restore–B	<input type="checkbox"/>	AtomicReadFile	<input type="checkbox"/>	<input checked="" type="checkbox"/>
		<input type="checkbox"/>	AtomicWriteFile	<input type="checkbox"/>	<input checked="" type="checkbox"/>
		<input type="checkbox"/>	ReinitializeDevice	<input type="checkbox"/>	<input checked="" type="checkbox"/>
DM-R-A	Device Management - Restart–A	<input type="checkbox"/>	UnconfirmedCOVNotification	<input type="checkbox"/>	<input checked="" type="checkbox"/>
DM-R-B	Device Management - Restart–B	<input type="checkbox"/>	UnconfirmedCOVNotification	<input checked="" type="checkbox"/>	<input type="checkbox"/>
DM-LM-A	Device Management - List Manipulation–A	<input type="checkbox"/>	AddListElement	<input checked="" type="checkbox"/>	<input type="checkbox"/>
		<input type="checkbox"/>	RemoveListElement	<input checked="" type="checkbox"/>	<input type="checkbox"/>
DM-LM-B	Device Management - List Manipulation–B	<input type="checkbox"/>	AddListElement	<input type="checkbox"/>	<input checked="" type="checkbox"/>
		<input type="checkbox"/>	RemoveListElement	<input type="checkbox"/>	<input checked="" type="checkbox"/>
DM-OCD-A	Device Management - Object Creation and Deletion–A	<input type="checkbox"/>	CreateObject	<input checked="" type="checkbox"/>	<input type="checkbox"/>
		<input type="checkbox"/>	DeleteObject	<input checked="" type="checkbox"/>	<input type="checkbox"/>
DM-OCD-B	Device Management - Object Creation and Deletion–B	<input type="checkbox"/>	CreateObject	<input type="checkbox"/>	<input checked="" type="checkbox"/>
		<input type="checkbox"/>	DeleteObject	<input type="checkbox"/>	<input checked="" type="checkbox"/>
DM-VT-A	Device Management - Virtual Terminal–A	<input type="checkbox"/>	VT-Open	<input checked="" type="checkbox"/>	<input type="checkbox"/>
		<input type="checkbox"/>	VT-Close	<input checked="" type="checkbox"/>	<input checked="" type="checkbox"/>
		<input type="checkbox"/>	VT-Data	<input checked="" type="checkbox"/>	<input checked="" type="checkbox"/>
DM-VT-B	Device Management - Virtual Terminal–B	<input type="checkbox"/>	VT-Open	<input type="checkbox"/>	<input checked="" type="checkbox"/>
		<input type="checkbox"/>	VT-Close	<input checked="" type="checkbox"/>	<input checked="" type="checkbox"/>
		<input type="checkbox"/>	VT-Data	<input checked="" type="checkbox"/>	<input checked="" type="checkbox"/>

4 Service Types

Service type	Service name	Supported	Remarks
Alarm and Event Services	AcknowledgeAlarm	<input checked="" type="checkbox"/>	
	ConfirmedCOVNotification	<input type="checkbox"/>	
	ConfirmedEventNotification	<input type="checkbox"/>	
	GetAlarmSummary	<input checked="" type="checkbox"/>	
	GetEnrollmentSummary	<input type="checkbox"/>	
	SubscribeCOV	<input checked="" type="checkbox"/>	
File Access Services	AtomicReadFile	<input type="checkbox"/>	
	AtomicWriteFile	<input type="checkbox"/>	
Object Access Services	AddListElement	<input type="checkbox"/>	
	RemoveListElement	<input type="checkbox"/>	
	CreateObject	<input type="checkbox"/>	
	DeleteObject	<input type="checkbox"/>	
	ReadProperty	<input checked="" type="checkbox"/>	
	ReadPropertyConditional	<input type="checkbox"/>	
	ReadPropertyMultiple	<input checked="" type="checkbox"/>	
	ReadRange	<input checked="" type="checkbox"/>	
	WriteProperty	<input checked="" type="checkbox"/>	
	WritePropertyMultiple	<input checked="" type="checkbox"/>	
Remote Device Management Services	DeviceCommunicationControl	<input checked="" type="checkbox"/>	
	ConfirmedPrivateTransfer	<input type="checkbox"/>	
	ConfirmedTextMessage	<input type="checkbox"/>	
	ReinitializeDevice	<input checked="" type="checkbox"/>	
Virtual Terminal Services	VtOpen	<input type="checkbox"/>	
	VtClose	<input type="checkbox"/>	
	VtData	<input type="checkbox"/>	
Security Services	Authenticate	<input type="checkbox"/>	
	RequestKey	<input type="checkbox"/>	
Unconfirmed Services	I-Am	<input checked="" type="checkbox"/>	
	I-Have	<input type="checkbox"/>	
	UnconfirmedCOVNotification	<input type="checkbox"/>	
	UnconfirmedEventNotification	<input type="checkbox"/>	
	UnconfirmedPrivateTransfer	<input type="checkbox"/>	
	UnconfirmedTextMessage	<input type="checkbox"/>	
	TimeSynchronization	<input checked="" type="checkbox"/>	
	UtcTimeSynchronization	<input type="checkbox"/>	
	Who-Has	<input checked="" type="checkbox"/>	
	Who-Is	<input checked="" type="checkbox"/>	
	LifeSafetyOperation	<input type="checkbox"/>	
	SubscribeCOVProperty	<input type="checkbox"/>	
	GetEventInformation	<input checked="" type="checkbox"/>	

5 Objects

5.1 Supported Object Types

The objects supported are shown in the table below.

Object Type	ID	Supported	Management Point
Analog-Input	0	<input checked="" type="checkbox"/>	
Analog-Output	1	<input checked="" type="checkbox"/>	
Analog-Value	2	<input checked="" type="checkbox"/>	
Averaging	18	<input type="checkbox"/>	
Binary-Input	3	<input checked="" type="checkbox"/>	
Binary-Output	4	<input checked="" type="checkbox"/>	
Binary-Value	5	<input checked="" type="checkbox"/>	
Calendar	6	<input checked="" type="checkbox"/>	
Command	7	<input type="checkbox"/>	
Device	8	<input checked="" type="checkbox"/>	
Event-Enrollment	9	<input type="checkbox"/>	
File	10	<input type="checkbox"/>	
Group	11	<input type="checkbox"/>	
Life-Safety-Point	21	<input type="checkbox"/>	
Life-Safety-Zone	22	<input type="checkbox"/>	
Loop	12	<input type="checkbox"/>	
Multistate-Input	13	<input checked="" type="checkbox"/>	
Multistate-Output	14	<input checked="" type="checkbox"/>	
Multistate-Value	19	<input checked="" type="checkbox"/>	
Notification-Class	15	<input checked="" type="checkbox"/>	
Program	16	<input type="checkbox"/>	
Schedule	17	<input checked="" type="checkbox"/>	
Trend-Log	20	<input checked="" type="checkbox"/>	
Trend-Log-Multiple	27	<input checked="" type="checkbox"/>	

5.2 Objects and properties

5.2.1 INBACMEB---0000 (Device Object Type)

Property Identifier	Property Datatype	Value	ASHRAE	IBOX
Object_Identifier	BACnetObjectIdentifier	(Device, 246000)	R	R
Object_Name	CharacterString	"INBACMEB---0000"	R	R
Object_Type	BACnetObjectType	DEVICE (8) (Device Object Type)	R	R
System_Status	BACnetDeviceStatus	OPERATIONAL (0)	R	R
Vendor_Name	CharacterString	"HMS Industrial Networks S.L.U"	R	R
Vendor_Identifier	Unsigned16	246	R	R
Model_Name	CharacterString	"INBACMEB---0000 "	R	R
Firmware_Revision	CharacterString	"1.0.0.0"	R	R
Application_Software_Version	CharacterString	"1.0.0.0"	R	R
Location	CharacterString	""	O	-
Description	CharacterString	"M-Bus to BACnet Gateway"	O	-
Protocol_Version	Unsigned	1	R	R
Protocol_Revision	Unsigned	12	R	R
Protocol_Services_Supported	BACnetServiceSupported	Refer to section 4 [Service Types]	R	R
Protocol_Object_Types_Supported	BACnetObjectTypes Supported	Refer to section 5.1 [Object Types]	R	R
Object_List	BACnetArray[N] of BACnetObjectIdentifier	BACnetARRAY[N]	R	R
Structured_Object_List	BACnetArray[N] of BACnetObjectIdentifier	-	O	-
Max_APDU_Length_Accepted	Unsigned	480 when MSTP / 1476 when BACnet/IP	R	R
Segmentation_Supported	BACnetSegmentation	SEGMENTED-BOTH (0)	R	R
Max_Segments_accepted	Unsigned	16	O	R
VT_Classes_Supported	List of BACnetVTClass	-	O	-
Active_VT_Sessions	List of BACnetVTSession	-	O	-
Local_Date	Date	Current date	O	R
Local_Time	Time	Current time	O	R
UTC_Offset	INTEGER	-	O	-
Daylight_Savings_Status	BOOLEAN	-	O	-
APDU_Segment_Timeout	Unsigned	3000	R	R
APDU_Timeout	Unsigned	3000	R	R
Number_of_APDU_Retries	Unsigned	3	R	R
List_Of_Session_Keys	List of BACnetSessionKey	-	O	-

Time_Synchronization_Recipients	List of BACnetRecipient	-	O	-
Max_Master * **	Unsigned	127	R	W
Max_Info_Frames *	Unsigned	1	O	R
Device_Address_Binding	List of BACnetAddressBinding	NULL (empty)	R	R
Database_Revision	Unsigned	0	R	R
Configuration_Files	BACnetArray[N] of BACnetObjectIdentifier	-	O	-
Last_Restore_Time	BACnetTimeStamp	-	O	-
Backup_Failure_Timeout	Unsigned16	-	O	-
Active_COV_Subscriptions	List of BACnetCOVSubscription	List of BACnetCOVSubscription	O	R
Slave_Proxy_Enable	BACnetArray[N] of BOOLEAN	-	O	-
Manual_Slave_Address_Binding	List of BACnetAddressBinding	-	O	-
Auto_Slave_Discovery	BACnetArray[N] of BOOLEAN	-	O	-
Slave_Address_Binding	BACnetAddressBinding	-	O	-
Last_Restart_Reason	BACnetRestartReason	-	O	-
Time_Of_Device_Restart	BACnetTimeStamp	-	O	-
Restart_Notification_Recipients	List of BACnetRecipient	-	O	-
UTC_Time_Synchronization_Recipients	List of BACnetRecipient	-	O	-
Time_Synchronization_Interval	Unsigned	-	O	-
Align_Intervals	BOOLEAN	-	O	-
Interval_Offset	Unsigned	-	O	-
Profile_Name	CharacterString	-	O	-

* Only available when MSTP is used

** Configurable through the configuration tool.

5.2.2 Analog Input Object Type

Property Identifier	Property Datatype	Value	ASHRAE	IBOX
Object_Identifier	BACnetObjectIdentifier	(Analog Input, 0)	R	R
Object_Name	CharacterString	<i>Configurable through BACnet and Config Tool</i>	R	R
Object_Type	BACnetObjectType	ANALOG_INPUT (0)	R	R
Present_Value	REAL	x	R	R
Description	CharacterString	-	O	-
Device_Type	CharacterString	-	O	-
Status_Flags	BACnetStatusFlags	{FALSE, FALSE/TRUE, FALSE, FALSE}	R	R
Event_State	BACnetEventState	STATE_NORMAL (0)	R	R
Reliability	BACnetReliability	NO_FAULT_DETECTED (0), UNRELIABLE_OTHER (7)	O	R
Out_Of_Service	BOOLEAN	FALSE	R	R
Update_Interval	Unsigned	-	O	-
Units	BACnetEngineeringUnits	<i>Configurable through BACnet and Config Tool</i>	R	R
Min_Pres_Value	REAL	-	O	-
Max_Pres_Value	REAL	-	O	-
Resolution	REAL	-	O	-
COV_Increment	REAL	0	O	R
Time_Delay	Unsigned	-	O	R*
Notification_Class	Unsigned	-	O	R*
High_Limit	REAL	-	O	R*
Low_Limit	REAL	-	O	R*
Deadband	REAL	-	O	R*
Limit_Enable	BACnetLimitEnable	-	O	R*
Event_Enable	BACnetEventTransitionBits	-	O	R*
Acked_Transitions	BACnetEventTransitionBits	-	O	R*
Notify_Type	BACnetNotifyType	-	O	R*
Event_Time_Stamps	BACnetArray[N] of BACnetTimeStamp	-	O	R*
Profile_Name	CharacterString	-	O	-

* Only available when specific object has a Notification Class configured

5.2.3 Analog Output Object Type

Property Identifier	Property Datatype	Value	ASHRAE	IBOX
Object_Identifier	BACnetObjectIdentifier	(Analog Output, 0)	R	R
Object_Name	CharacterString	<i>Configurable through BACnet and Config Tool</i>	R	R
Object_Type	BACnetObjectType	ANALOG_OUTPUT (1)	R	R
Present_Value	REAL	x	W	W
Description	CharacterString	-	O	-
Device_Type	CharacterString	-	O	-
Status_Flags	BACnetStatusFlags	{FALSE, FALSE, FALSE, FALSE}	R	R
Event_State	BACnetEventState	STATE_NORMAL (0)	R	R
Reliability	BACnetReliability	NO_FAULT_DETECTED (0)	O	R
Out_Of_Service	BOOLEAN	FALSE	R	R
Update_Interval	Unsigned	-	O	-
Units	BACnetEngineeringUnits	<i>Configurable through BACnet and Config Tool</i>	R	R
Min_Pres_Value	REAL	-	O	-
Max_Pres_Value	REAL	-	O	-
Resolution	REAL	-	O	-
COV_Increment	REAL	0	O	R
Priority_Array	BACnetPriorityArray	BACnetPriorityArray	R	R
Relinquish_Default	Unsigned	<i>Configurable through BACnet and Config Tool</i>	R	R
Time_Delay	Unsigned	-	O	R*
Notification_Class	Unsigned	-	O	R*
High_Limit	REAL	-	O	R*
Low_Limit	REAL	-	O	R*
Deadband	REAL	-	O	R*
Limit_Enable	BACnetLimitEnable	-	O	R*
Event_Enable	BACnetEventTransitionBits	-	O	R*
Acked_Transitions	BACnetEventTransitionBits	-	O	R*
Notify_Type	BACnetNotifyType	-	O	R*
Event_Time_Stamps	BACnetArray[N] of BACnetTimeStamp	-	O	R*
Profile_Name	CharacterString	-	O	-

* Only available when specific object has a Notification Class configured

5.2.4 Analog Value Object Type

Property Identifier	Property Datatype	Value	ASHRAE	IBOX
Object_Identifier	BACnetObjectIdentifier	(Analog Value, 0)	R	R
Object_Name	CharacterString	<i>Configurable through BACnet and Config Tool</i>	R	R
Object_Type	BACnetObjectType	ANALOG_VALUE (2)	R	R
Present_Value	REAL	x	R	W
Description	CharacterString	-	O	-
Status_Flags	BACnetStatusFlags	{FALSE, FALSE, FALSE, FALSE}	R	R
Event_State	BACnetEventState	STATE_NORMAL (0)	R	R
Reliability	BACnetReliability	NO_FAULT_DETECTED (0)	O	R
Out_Of_Service	BOOLEAN	FALSE	R	R
Update_Interval	Unsigned	-	O	-
Units	BACnetEngineeringUnits	<i>Configurable through BACnet and Config Tool</i>	R	R
Min_Pres_Value	REAL	-	O	-
Max_Pres_Value	REAL	-	O	-
Resolution	REAL	-	O	-
COV_Increment	REAL	0	O	R
Time_Delay	Unsigned	-	O	R*
Notification_Class	Unsigned	-	O	R*
High_Limit	REAL	-	O	R*
Low_Limit	REAL	-	O	R*
Deadband	REAL	-	O	R*
Limit_Enable	BACnetLimitEnable	-	O	R*
Event_Enable	BACnetEventTransitionBits	-	O	R*
Acked_Transitions	BACnetEventTransitionBits	-	O	R*
Notify_Type	BACnetNotifyType	-	O	R*
Event_Time_Stamps	BACnetArray[N] of BACnetTimeStamp	-	O	R*
Profile_Name	CharacterString	-	O	-

* Only available when specific object has a Notification Class configured

5.2.5 Binary Input Object Type

Property Identifier	Property Datatype	Value	ASHRAE	IBOX
Object_Identifier	BACnetObjectIdentifier	(Binary Input, 0)	R	R
Object_Name	CharacterString	<i>Configurable through BACnet and Config Tool</i>	R	R
Object_Type	BACnetObjectType	BINARY_INPUT (3)	R	R
Present_Value	BACnetBinaryPV	INACTIVE (0) / ACTIVE (1)	R	R
Description	CharacterString	-	O	-
Device_Type	CharacterString	-	O	-
Status_Flags	BACnetStatusFlags	{FALSE, FALSE/TRUE, FALSE, FALSE}	R	R
Event_State	BACnetEventState	STATE_NORMAL (0)	R	R
Reliability	BACnetReliability	NO_FAULT_DETECTED (0), UNRELIABLE_OTHER (7)	O	R
Out_Of_Service	BOOLEAN	FALSE	R	R
Polarity	BACnetPolarity	NORMAL (0)	R	R
Inactive_Text	CharacterString	<i>Configurable through BACnet and Config Tool</i>	O	R
Active_Text	CharacterString	<i>Configurable through BACnet and Config Tool</i>	O	R
Change_Of_State_Time	BACnetDatetime	-	O	R
Change_Of_State_Count	Unsigned	-	O	R
Time_Of_State_Count_Reset	BACnetDatetime	-	O	R
Elapsed_Active_Time	Unsigned	-	O	R
Time_Of_Active_Time_Reset	BACnetDatetime	-	O	R
Time_Delay	Unsigned	-	O	R*
Notification_Class	Unsigned	-	O	R*
Alarm_Value	BACnetBinaryPV	-	O	R*
Event_Enable	BACnetEventTransitionBits	-	O	R*
Acked_Transitions	BACnetEventTransitionBits	-	O	R*
Notify_Type	BACnetNotifyType	-	O	R*
Event_Time_Stamps	BACnetArray[N] of BACnetTimeStamp	-	O	R*
Profile_Name	CharacterString	-	O	-

* Only available when specific object has a Notification Class configured

5.2.6 Binary Output Object Type

Property Identifier	Property Datatype	Value	ASHRAE	IBOX
Object_Identifier	BACnetObjectIdentifier	(Binary Output, 0)	R	R
Object_Name	CharacterString	<i>Configurable through BACnet and Config Tool</i>	R	R
Object_Type	BACnetObjectType	BINARY_OUTPUT (4)	R	R
Present_Value	BACnetBinaryPV	INACTIVE (0) / ACTIVE (1)	W	W
Description	CharacterString	-	O	-
Device_Type	CharacterString	-	O	-
Status_Flags	BACnetStatusFlags	{FALSE, FALSE, FALSE, FALSE}	R	R
Event_State	BACnetEventState	STATE_NORMAL (0)	R	R
Reliability	BACnetReliability	NO_FAULT_DETECTED (0)	O	R
Out_Of_Service	BOOLEAN	FALSE	R	R
Polarity	BACnetPolarity	NORMAL (0)	R	R
Inactive_Text	CharacterString	<i>Configurable through BACnet and Config Tool</i>	O	R
Active_Text	CharacterString	<i>Configurable through BACnet and Config Tool</i>	O	R
Change_Of_State_Time	BACnetDatetime	-	O	R
Change_Of_State_Count	Unsigned	-	O	R
Time_Of_State_Count_Reset	BACnetDatetime	-	O	R
Elapsed_Active_Time	Unsigned	-	O	R
Time_Of_Active_Time_Reset	BACnetDatetime	-	O	R
Minimum_Off_Time	Unsigned32	-	O	-
Minimum_On_Time	Unsigned32	-	O	-
Priority_Array	BACnetPriorityArray	BACnetPriorityArray	R	R
Relinquish_Default	BACnetBinaryPV	INACTIVE (0)	R	R
Time_Delay	Unsigned	-	O	R*
Notification_Class	Unsigned	-	O	R*
Feedback_Value	BACnetBinaryPV	-	O	W
Event_Enable	BACnetEventTransitionBits	-	O	R*
Acked_Transitions	BACnetEventTransitionBits	-	O	R*
Notify_Type	BACnetNotifyType	-	O	R*
Event_Time_Stamps	BACnetArray[N] of BACnetTimeStamp	-	O	R*
Profile_Name	CharacterString	-	O	-

* Only available when specific object has a Notification Class configured

5.2.7 Binary Value Object Type

Property Identifier	Property Datatype	Value	ASHRAE	IBOX
Object_Identifier	BACnetObjectIdentifier	(Binary Value, 0)	R	R
Object_Name	CharacterString	<i>Configurable through BACnet and Config Tool</i>	R	R
Object_Type	BACnetObjectType	BINARY_VALUE (5)	R	R
Present_Value	BACnetBinaryPV	INACTIVE (0) / ACTIVE (1)	W	W
Description	CharacterString	-	O	-
Status_Flags	BACnetStatusFlags	{FALSE, FALSE, FALSE, FALSE}	R	R
Event_State	BACnetEventState	STATE_NORMAL (0)	R	R
Reliability	BACnetReliability	NO_FAULT_DETECTED (0)	O	R
Out_Of_Service	BOOLEAN	FALSE	R	R
Inactive_Text	CharacterString	<i>Configurable through BACnet and Config Tool</i>	O	R
Active_Text	CharacterString	<i>Configurable through BACnet and Config Tool</i>	O	R
Change_Of_State_Time	BACnetDatetime	-	O	R
Change_Of_State_Count	Unsigned	-	O	R
Time_Of_State_Count_Reset	BACnetDatetime	-	O	R
Elapsed_Active_Time	Unsigned	-	O	R
Time_Of_Active_Time_Reset	BACnetDatetime	-	O	R
Minimum_Off_Time	Unsigned32	-	O	-
Minimum_On_Time	Unsigned32	-	O	-
Priority_Array	BACnetPriorityArray	BACnetPriorityArray	R	R
Relinquish_Default	BACnetBinaryPV	INACTIVE (0)	R	R
Time_Delay	Unsigned	-	O	R*
Notification_Class	Unsigned	-	O	R*
Alarm_Value	BACnetBinaryPV	-	O	R*
Event_Enable	BACnetEventTransitionBits	-	O	R*
Acked_Transitions	BACnetEventTransitionBits	-	O	R*
Notify_Type	BACnetNotifyType	-	O	R*
Event_Time_Stamps	BACnetArray[N] of BACnetTimeStamp	-	O	R*
Profile_Name	CharacterString	-	O	-

* Only available when specific object has a Notification Class configured

5.2.8 Multistate Input Object Type

Property Identifier	Property Datatype	Value	ASHRAE	IBOX
Object_Identifier	BACnetObjectIdentifier	(Multi-state Input, 0)	R	R
Object_Name	CharacterString	<i>Configurable through BACnet and Config Tool</i>	R	R
Object_Type	BACnetObjectType	MULTISTATE_INPUT (13)	R	R
Present_Value	Unsigned	x	R	R
Description	CharacterString	-	O	-
Device_Type	CharacterString	-	O	-
Status_Flags	BACnetStatusFlags	{FALSE, FALSE/TRUE, FALSE, FALSE}	R	R
Event_State	BACnetEventState	STATE_NORMAL (0)	R	R
Reliability	BACnetReliability	NO_FAULT_DETECTED (0), UNRELIABLE_OTHER (7)	O	R
Out_Of_Service	BOOLEAN	FALSE	R	R
Number_Of_States	Unsigned	<i>Configurable through BACnet and Config Tool</i>	R	R
State_Text	BACnetArray[N] of CharacterString	-	O	R
Time_Delay	Unsigned	-	O	R*
Notification_Class	Unsigned	-	O	R*
Alarm_Values	List of Unsigned	-	O	R*
Fault_Values	List of Unsigned	-	O	R*
Event_Enable	BACnetEventTransitionBits	-	O	R*
Acked_Transitions	BACnetEventTransitionBits	-	O	R*
Notify_Type	BACnetNotifyType	-	O	R*
Event_Time_Stamps	BACnetArray[N] of BACnetTimeStamp	-	O	R*
Profile_Name	CharacterString	-	O	-

* Only available when specific object has a Notification Class configured

5.2.9 Multistate Output Object Type

Property Identifier	Property Datatype	Value	ASHRAE	IBOX
Object_Identifier	BACnetObjectIdentifier	(Multi-state Output, 0)	R	R
Object_Name	CharacterString	<i>Configurable through BACnet and Config Tool</i>	R	R
Object_Type	BACnetObjectType	MULTISTATE_OUTPUT (14)	R	R
Present_Value	Unsigned	x	W	W
Description	CharacterString	-	O	-
Device_Type	CharacterString	-	O	-
Status_Flags	BACnetStatusFlags	{FALSE, FALSE, FALSE, FALSE}	R	R
Event_State	BACnetEventState	STATE_NORMAL (0)	R	R
Reliability	BACnetReliability	NO_FAULT_DETECTED (0)	O	R
Out_Of_Service	BOOLEAN	FALSE	R	R
Number_Of_States	Unsigned	<i>Configurable through BACnet and Config Tool</i>	R	R
State_Text	BACnetArray[N] of CharacterString		O	R
Priority_Array	BACnetPriorityArray	BACnetPriorityArray	R	R
Relinquish_Default	Unsigned	1	R	R
Time_Delay	Unsigned	-	O	R*
Notification_Class	Unsigned	-	O	R*
Feedback_Value	Unsigned	-	O	W
Event_Enable	BACnetEventTransitionBits	-	O	R*
Acked_Transitions	BACnetEventTransitionBits	-	O	R*
Notify_Type	BACnetNotifyType	-	O	R*
Event_Time_Stamps	BACnetArray[N] of BACnetTimeStamp	-	O	R*
Profile_Name	CharacterString	-	O	-

* Only available when specific object has a Notification Class configured

5.2.10 Multistate Value Object Type

Property Identifier	Property Datatype	Value	ASHRAE	IBOX
Object_Identifier	BACnetObjectIdentifier	(Multi-state Output, 0)	R	R
Object_Name	CharacterString	<i>Configurable through BACnet and Config Tool</i>	R	R
Object_Type	BACnetObjectType	MULTISTATE_VALUE (19)	R	R
Present_Value	Unsigned	x	W	W
Description	CharacterString	-	O	-
Status_Flags	BACnetStatusFlags	{FALSE, FALSE, FALSE, FALSE}	R	R
Event_State	BACnetEventState	STATE_NORMAL (0)	R	R
Reliability	BACnetReliability	NO_FAULT_DETECTED (0)	O	R
Out_Of_Service	BOOLEAN	FALSE	R	R
Number_Of_States	Unsigned	<i>Configurable through BACnet and Config Tool</i>	R	R
State_Text	BACnetArray[N] of CharacterString		O	R
Priority_Array	BACnetPriorityArray	-	R	R
Relinquish_Default	Unsigned	-	R	R
Time_Delay	Unsigned	-	O	R*
Notification_Class	Unsigned	-	O	R*
Alarm_Values	Unsigned	-	O	R*
Fault_Values	Unsigned		O	R*
Event_Enable	BACnetEventTransitionBits	-	O	R*
Acked_Transitions	BACnetEventTransitionBits	-	O	R*
Notify_Type	BACnetNotifyType	-	O	R*
Event_Time_Stamps	BACnetArray[N] of BACnetTimeStamp	-	O	R*
Profile_Name	CharacterString	-	O	-

* Only available when specific object has a Notification Class configured

5.2.11 Calendar Object Type

Property Identifier	Property Datatype	Value	ASHRAE	IBOX
Object_Identifier	BACnetObjectIdentifier	(Calendar, 6)	R	R
Object_Name	CharacterString	<i>Configurable through BACnet and Config Tool</i>	R	R
Object_Type	BACnetObjectType	CALENDAR (6)	R	R
Description	CharacterString	-	O	-
Present_Value	BOOLEAN	-	R	R
Date_List	BACnetLIST of BACnetCalendarEntry	-	R	W
Profile_Name	BACnetARRAY[N] of BACnetPropertyIdentifier	-	O	-

5.2.12 Schedule Object Type

Property Identifier	Property Datatype	Value	ASHRAE	IBOX
Object_Identifier	BACnetObjectIdentifier	(Schedule, 17)	R	R
Object_Name	CharacterString	<i>Configurable through BACnet and Config Tool</i>	R	R
Object_Type	BACnetObjectType	SCHEDULE (17)	R	R
Present_Value	Any	-	R	R
Description	CharacterString	-	O	-
Effective_Period	BACnetDateRange	-	R	W
Weekly_Schedule	BACnetARRAY[7] of BACnetDailySchedule	-	R	W
Exception_Schedule	BACnetARRAY[N] of BACnetSpecialEvent	-	R	W
Schedule_Default	Any	-	R	W
List_Of_Object_Property_References	BACnetLIST of BACnetDeviceObjectPropertyReference	-	R	R
Priority_For_Writing	Unsigned(1..16)	-	R	W
Status_Flags	BACnetStatusFlags	-	R	R
Reliability	BACnetReliability	-	R	R
Out_Of_Service	BOOLEAN	-	R	R
Event_Detection_Enable	BOOLEAN	-	O	-
Notification_Class	Unsigned	-	O	-
Event_Enable	BACnetEventTransitionBits	-	O	-
Event_State	BACnetEventState	-	O	-
Acked_Transitions	BACnetEventTransitionBits	-	O	-
Notify_Type	BACnetNotifyType	-	O	-
Event_Time_Stamps	BACnetARRAY[3] of BACnetTimeStamp	-	O	-
Event_Message_Texts	BACnetARRAY[3] of CharacterString	-	O	-
Event_Message_Texts_Config	BACnetARRAY[3] of CharacterString	-	O	-
Reliability_Evaluation_Inhibit	BOOLEAN	-	O	-
Profile_Name	CharacterString	-	O	-

5.2.13 Notification Class Object Type

Property Identifier	Property Datatype	Value	ASHRAE	IBOX
Object_Identifier	BACnetObjectIdentifier	(Notification_Class, 15)	R	R
Object_Name	CharacterString	<i>Configurable through BACnet and Config Tool</i>	R	R
Object_Type	BACnetObjectType	NOTIFICATION_CLASS (15)	R	R
Description	CharacterString	-	O	-
Notification_Class	Unsigned	-	R	R
Priority	BACnetARRAY[3] of Unsigned	-	R	R
Ack_Required	BACnetEventTransitionBits	-	R	R
Recipient_List	BACnetLIST of BACnetDestination	-	R	R
Profile_Name	CharacterString	-	O	-

5.2.14 Trend Log Object Type

Property Identifier	Property Datatype	Value	ASHRAE	IBOX
Object_Identifier	BACnetObjectIdentifier	(Trend_Log, 20)	R	R
Object_Name	CharacterString	<i>Configurable through BACnet and Config Tool</i>	R	R
Object_Type	BACnetObjectType	TREND_LOG (20)	R	R
Description	CharacterString	-	O	-
Enable	BOOLEAN		R	W
Start_Time	BACnetDateTime		O	W
Stop_Time	BACnetDateTime		O	W
Log_DeviceObjectProperty	BACnetDeviceObjectPropertyReference		O	-
Log_Interval	Unsigned		O	-
COV_Resubscription_Interval	Unsigned		O	-
Client_COV_Increment	BACnetClientCOV		O	-
Stop_When_Full	BOOLEAN		R	R
Buffer_Size	Unsigned		R	R
Log_Buffer	List of BACnetLogRecord		R	R
Record_Count	Unsigned		R	W
Total_Record_Count	Unsigned		R	R
Notification_Threshold	Unsigned		O	R*
Records_Since_Notification	Unsigned		O	R*
Last_Notify_Record	Unsigned		O	R*
Event_State	BACnetEventState		R	R
Notification_Class	Unsigned		O	R*
Event_Enable	BACnetEventTransitionBits		O	R*
Acked_Transitions	BACnetEventTransitionBits		O	R*
Notify_Type	BACnetNotifyType		O	R*
Event_Time_Stamps	BACnetARRAY[3] of BACnetTimeStamp		O	R*
EventMessageTexts	BACnetARRAY[3] of CharacterString		O	R*
Profile_Name	CharacterString		O	-
Logging_Type	BACnetLoggingType		R	R
Status_Flags	BACnetStatusFlags		R	R

* Only available when specific object has a Notification Class configured

5.2.15 Trend Log Multiple Object Type

Property Identifier	Property Datatype	Value	ASHRAE	IBOX
Object_Identifier	BACnetObjectIdentifier	(Trend_Log_Multiple, 27)	R	R
Object_Name	CharacterString	<i>Configurable through BACnet and Config Tool</i>	R	R
Object_Type	BACnetObjectType	TREND_LOG_MULTIPLE (27)	R	R
Description	CharacterString	-	O	-
Enable	BOOLEAN		R	W
Start_Time	BACnetDateTime		O	W
Stop_Time	BACnetDateTime		O	W
Log_DeviceObjectProperty	BACnetARRAY[10] of BACnetDeviceObjectPropertyReference		O	R
Log_Interval	Unsigned		O	-
COV_Resubscription_Interval	Unsigned		O	-
Client_COV_Increment	BACnetClientCOV		O	-
Stop_When_Full	BOOLEAN		R	R
Buffer_Size	Unsigned		R	R
Log_Buffer	List of BACnetLogRecord		R	R
Record_Count	Unsigned		R	W
Total_Record_Count	Unsigned		R	R
Notification_Threshold	Unsigned		O	R*
Records_Since_Notification	Unsigned		O	R*
Last_Notify_Record	Unsigned		O	R*
Event_State	BACnetEventState		R	R
Notification_Class	Unsigned		O	R*
Event_Enable	BACnetEventTransitionBits		O	R*
Acked_Transitions	BACnetEventTransitionBits		O	R*
Notify_Type	BACnetNotifyType		O	R*
Event_Time_Stamps	BACnetARRAY[3] of BACnetTimeStamp		O	R*
EventMessageTexts	BACnetARRAY[3] of CharacterString		O	R*
Profile_Name	CharacterString		O	-
Logging_Type	BACnetLoggingType		R	R
Status_Flags	BACnetStatusFlags		R	R

* Only available when specific object has a Notification Class configured

6 Connections

Find below information regarding the Intesis connections available.

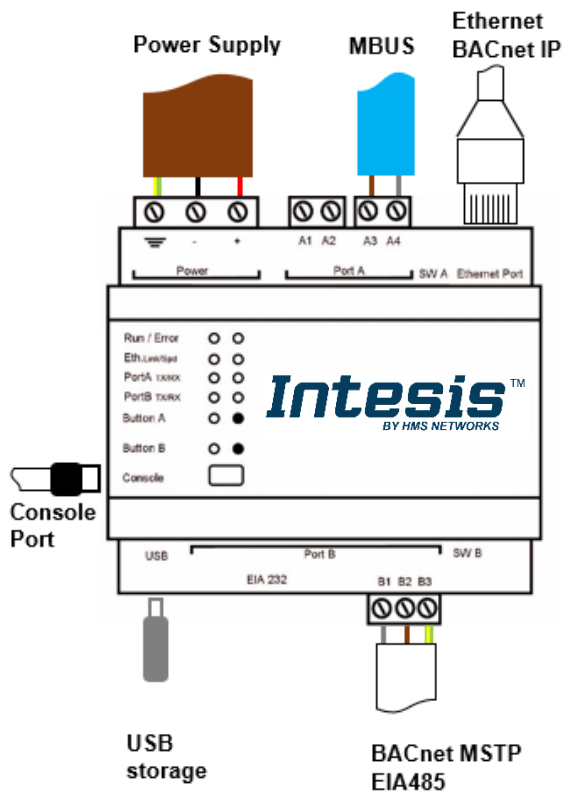

Power Supply

Must use NEC Class 2 or Limited Power Source (LPS) and SELV rated power supply.

Respect polarity applied of terminals (+) and (-). Be sure the voltage applied is within the range admitted (check table below). The power supply can be connected to earth but only through the negative terminal, never through the positive terminal.

Ethernet / BACnet IP

Connect the cable coming from the IP network to the connector ETH of the gateway. Use an Ethernet CAT5 cable. If communicating through the LAN of the building, contact the network administrator and make sure traffic on the port used is allowed through all the LAN path (check the gateway user manual for more information). With factory settings, after powering up the gateway, DHCP will be enabled for 30 seconds. After that time, if no IP is provided by a DHCP server, the default IP 192.168.100.246 will be set.

PortA / M-Bus

Connect the EIA485 bus to connectors A3 (+), A4 (-) of gateway's PortA. Respect the polarity.

PortB / BACnet MSTP

Connect the EIA485 bus to connectors B1 (-), B2 (+) and B3 (SNGD) of gateway's PortB. Respect the polarity.

Note for PortA and PortB; Remember the characteristics of the standard EIA485 bus: maximum distance of 1200 meters, maximum 32 devices connected to the bus, and in each end of the bus it must be a termination resistor of 120 Ω. The gateway has an internal bus biasing circuit that incorporates the termination resistor. If you install the gateway in one of the ends of the bus, then do not install an additional termination resistor in that end.

Console Port

Connect a mini-type B USB cable from your computer to the gateway to allow communication between the Configuration Software and the gateway. Remember that Ethernet connection is also allowed. Check the user manual for more information.

USB

Connect a USB storage device (not a HDD) if required. Check the user manual for more information.

Ensure proper space for all connectors when mounted (see section 9).

6.1 Powering the device

A power supply working with any of the voltage range allowed is needed (check section 8). Once connected the RUN led (Figure above) will turn on.

WARNING! In order to avoid earth loops that can damage the gateway and/or any other equipment connected to it, we strongly recommend the use of DC power supplies, floating or with the negative terminal connected to earth. **Never use a DC power supply with the positive terminal connected to earth.**

6.2 Connection to BACnet

6.2.1 BACnet IP

Connect the communication cable coming from the network hub or switch to the ETH port (Figure above) of Intesis. The cable to be used shall be a straight Ethernet UTP/FTP CAT5 cable

In case there is no response from the BACnet devices to the frames sent by Intesis, check that they are operative and reachable from the network connection used by Intesis. Check the Intesis Ethernet interface sending *Pings* to its IP address using a PC connected to the same Ethernet network.

Check as well with the network admin that there are no limitations regarding UDP communication or ports blocked.

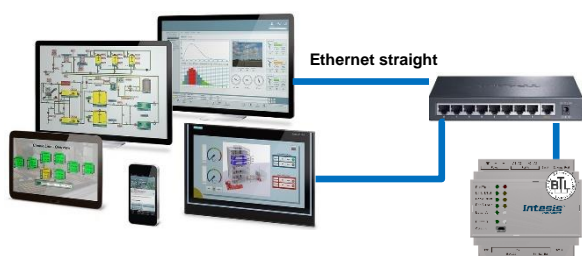

BACnet IP connection using switch/hub and straight cable



BACnet IP connection without switch/hub and crossed cable

6.2.2 BACnet MSTP

Connect the EIA485 bus to connectors B1 (-), B2 (+) and B3 (SNGD) of gateway's PortB. Respect the polarity.

Remember the characteristics of the standard EIA485 bus: maximum distance of 1200 meters, maximum 32 devices connected to the bus, and in each end of the bus it must be a termination resistor of 120 Ω . The gateway has an internal bus biasing circuit that incorporates the termination resistor. If you install the gateway in one of the ends of the bus, then do not install an additional termination resistor in that end.

6.3 Connection to M-Bus

The gateway connects to the M-Bus system directly without requiring any external RS232 or RS485 to M-Bus level converter.

Connect the M-Bus bus to connectors A3 (+) and A4 (-) of gateway's PortA.

Remember that the Intesis provides 36VDC M-Bus voltage to the bus, acting as a M-Bus level converter as well.

In case there is no response from the M-Bus device(s) to the frames sent by Intesis, check that they are operative and reachable from the network connection used by Intesis. You can use an EIA-485-to-USB converter and a M-Bus Master software (such as MBSheet or similar) to double check the M-Bus installation.

6.4 Connection to the configuration tool

This action allows the user to have access to configuration and monitoring of the device (more information can be found in the configuration tool User Manual). Two methods to connect to the PC can be used:

- **Ethernet:** Using the Ethernet port of Intesis.
- **USB:** Using the console port of Intesis, connect a USB cable from the console port to the PC.

7 Set-up process and troubleshooting

7.1 Pre-requisites

It is necessary to have a M-Bus installation, device or interface operative and well connected to the corresponding M-Bus port of Intesis and a BACnet MSTP Master or BACnet IP client connected to their corresponding ports as well.

Connectors, connection cables, PC to use the configuration tool and other auxiliary material, if needed, are not supplied by HMS Industrial Networks S.L.U for this standard integration.

Items supplied by HMS Networks for this integration are:

- Intesis gateway.
- Link to download the configuration tool.
- Product documentation.

7.2 Intesis MAPS. Configuration & monitoring tool for Intesis BACnet series

7.2.1 Introduction

Intesis MAPS is a Windows® compatible software developed specifically to monitor and configure Intesis BACnet series.

The installation procedure and main functions are explained in the *Intesis MAPS User Manual*. This document can be downloaded from the link indicated in the installation sheet supplied with the Intesis device or in the product website at www.intesis.com

In this section, only the specific case of BACnet to M-BUS systems will be covered.

Please check the Intesis MAPS user manual for specific information about the different parameters and how to configure them.

7.2.2 Connection

To configure the Intesis connection parameters press on the **Connection** button in the *menu bar*.

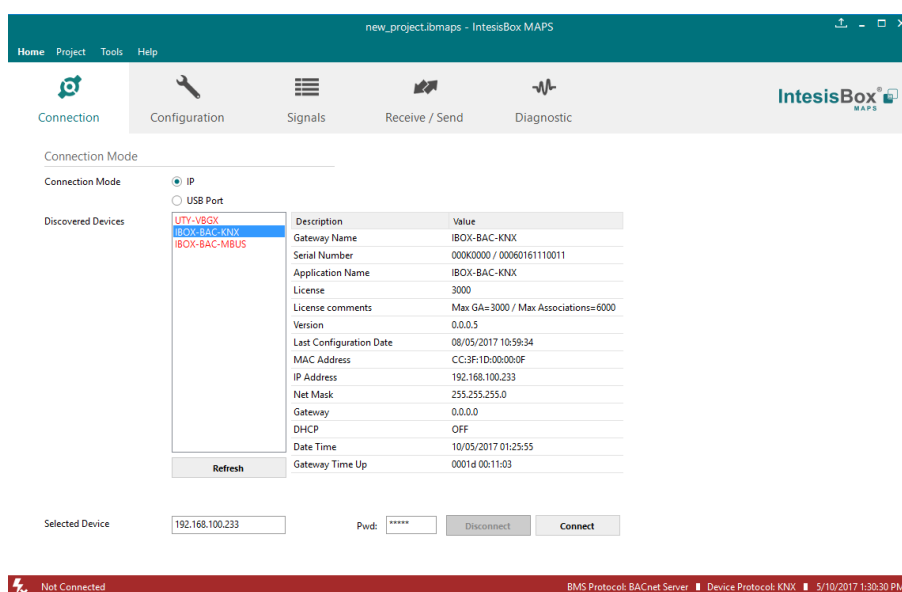

Figure 7.1 MAPS connection

7.2.3 Configuration tab

Select the **Configuration** tab to configure the connection parameters. Three subsets of information are shown in this window: General (Gateway general parameters), BACnet Server (BACnet interface configuration) and M-Bus Master (M-Bus interface parameters).

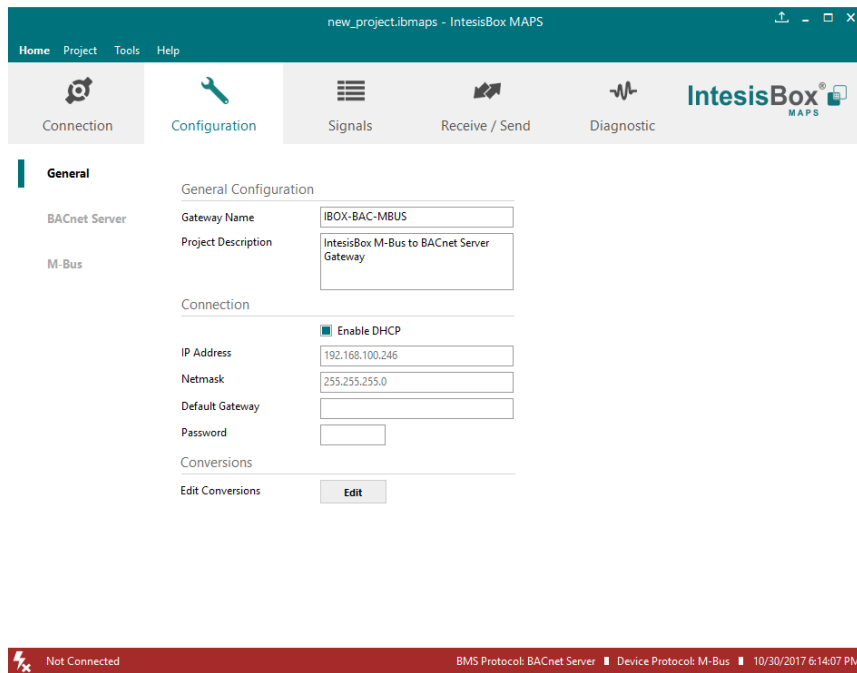

Figure 7.2 Intesis MAPS configuration tab

7.2.4 Signals

All available objects, Object Instances, its corresponding M-Bus register and other main parameters are listed in the signals tab. More information on each parameter and how to configure it can be found in the Intesis MAPS user manual.

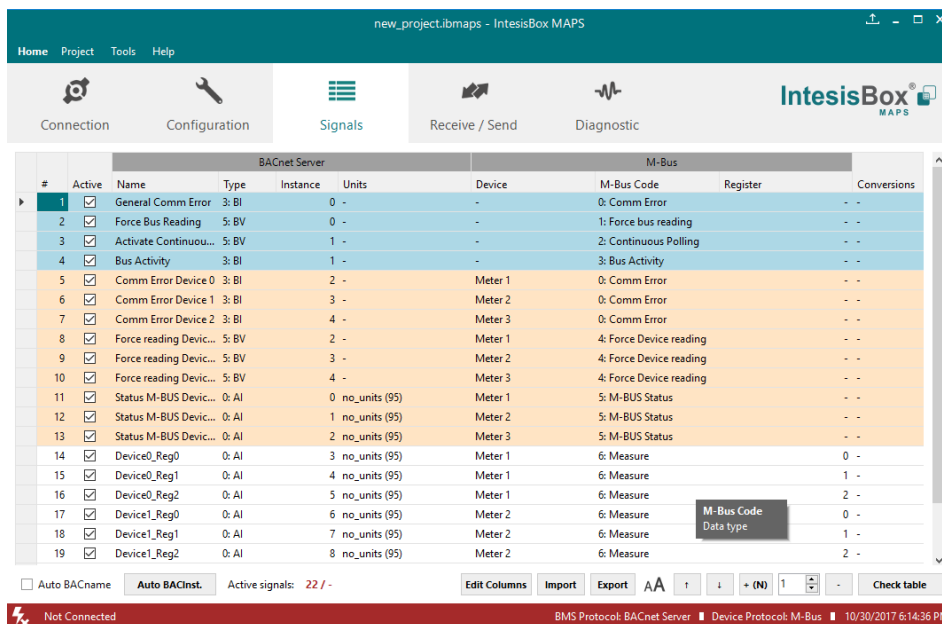

Figure 7.3 Intesis MAPS Signals tab

7.2.5 Sending the configuration to Intesis

When the configuration is finished, follow the next steps.

- 1.- Click on **Save** button to save the project to the project folder on your hard disk (more information in Intesis MAPS User Manual).
- 2.- You will be prompted to generate the configuration file to be sent to the gateway.
 - a.- If **Yes** is selected, the file containing the configuration for the gateway will be generated and saved also into the project folder.
 - b.- If **NO** is selected, remember that the binary file with the project needs to be generated before the Intesis starts to work as expected.
- 3.- Press the **Send File** button to send the binary file to the Intesis device. The process of file transmission can be monitored in the Intesis Communication Console window. Intesis will reboot automatically once the new configuration is loaded.

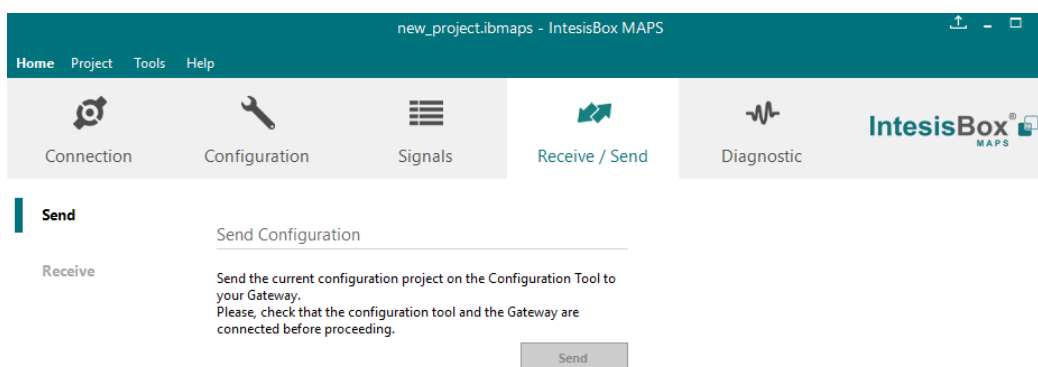

Figure 7.4 Intesis MAPS Receive/Send tab

After any configuration change, do not forget to send the configuration file to the Intesis using button Send File.

7.2.6 Diagnostic

To help integrators in the commissioning tasks and troubleshooting, the Configuration Tool offers some specific tools and viewers.

In order to start using the diagnostic tools, connection with the Gateway is required.

The Diagnostic section is composed by two main parts: Tools and Viewers.

- **Tools**
Use the tools section to check the current hardware status of the box, log communications into compressed files to be sent to the support, change the Diagnostic panels' view or send commands to the gateway.
- **Viewers**
In order to check the current status, viewer for the Internal and External protocols are available. It is also available a generic Console viewer for general information about communications and the gateway status and finally a Signals Viewer to simulate the BMS behavior or to check the current values in the system.

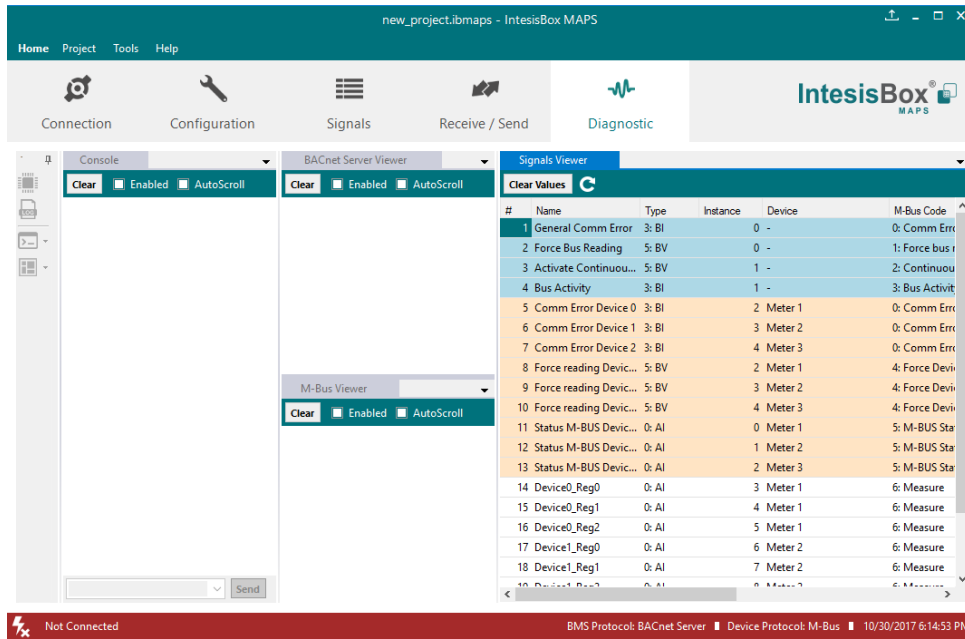

Figure 7.5 Diagnostic

More information about the Diagnostic section can be found in the Configuration Tool manual.

7.3 Set-up procedure

1. Install Intesis MAPS on your laptop, use the setup program supplied for this and follow the instructions given by the Installation wizard.
2. Install Intesis in the desired installation site. Installation can be on DIN rail or on a stable not vibrating surface (DIN rail mounted inside a metallic industrial cabinet connected to ground is recommended).
3. If using BACnet IP, connect the communication cable coming from the BACnet IP network to the port marked as Ethernet on Intesis (More details in section 6).

If using BACnet MSTP, connect the communication cables coming from the BACnet MSTP network to the port marked as Port B on Intesis (More details in section 6).

4. Connect the M-Bus communication cable coming from the M-Bus network to the port marked as Port A on Intesis (More details in section 6).
5. Power up Intesis. The supply voltage should be any of the voltage range allowed (check section 8). Take care of the polarity of the supply voltage applied.

WARNING! In order to avoid earth loops that can damage Intesis and/or any other equipment connected to it, we strongly recommend the use of DC power supplies, floating or with the negative terminal connected to earth. **Never use a DC power supply with the positive terminal connected to earth.**

6. If you want to connect using IP, connect the Ethernet cable from the laptop PC to the port marked as Ethernet of Intesis (More details in section 6).

If you want to connect using USB, connect the USB cable from the laptop PC to the port marked as Console of Intesis (More details in section 6).

7. Open Intesis MAPS, create a new project selecting a copy of the one named **INBACMEB---0000**
8. Modify the configuration as desired, save it and download the configuration file to Intesis as explained in the Intesis MAPS user manual.
9. Visit the Diagnostic section and check that there is communication activity, some TX frames and some other RX frames. This means that the communication with the BACnet master device and M-Bus Slave devices is OK. In case there is no communication activity between Intesis and the BACnet and/or M-Bus devices, check that those are operative: check the baud rate, the communication cable used to connect all devices and any other communication parameter.

8 Electrical & Mechanical Features



Enclosure	Plastic, type PC (UL 94 V-0) Net dimensions (d×w×h): 90x88x56 mm Recommended space for installation (d×w×h): 130x100x100mm Color: Light Grey, RAL 7035	Battery	Size: Coin 20mm x 3.2mm Capacity: 3V / 225mAh Type: Manganese Dioxide Lithium
Mounting	Wall, DIN rail EN60715 TH35.	Console Port	Mini Type-B USB 2.0 compliant 1500VDC isolation
Terminal Wiring (for power supply and low-voltage signals)	Per terminal: solid wires or stranded wires (twisted or with ferrule) 1 core: 0.5mm ² ... 2.5mm ² 2 cores: 0.5mm ² ... 1.5mm ² 3 cores: not permitted If cables are more than 3.05 meters long, Class 2 cable is required.	USB port	Type-A USB 2.0 compliant Only for USB flash storage device (<i>USB pen drive</i>) Power consumption limited to 150mA (<i>HDD connection not allowed</i>)
Power	1 x Plug-in screw terminal block (3 poles) Positive, Negative, Earth 24VDC +/-10%	Push Button	Button A: Check the user manual Button B: Check the user manual
Ethernet	1 x Ethernet 10/100 Mbps RJ45 2 x Ethernet LED: port link and activity	Operation Temperature	0°C to +60°C
Port A	1 x MBUS port (Plug-in screw terminal block orange 2 poles) MBUS power consumption: 210mA Voltage rating: 36VDC 1 x Plug-in screw terminal block green (2 poles) Reserved for future use	Operational Humidity	5 to 95%, no condensation
Switch A (SWA)	1 x DIP-Switch for serial EIA485 configuration: Reserved for future use	Protection	IP20 (IEC60529)
PORT B	1 x Serial EIA232 (SUB-D9 male connector) Reserved for future use 1 x Serial EIA485 Plug-in screw terminal block (3 poles) A, B, SGND (Reference ground or shield) 1500VDC isolation from other ports (except PORT B: EIA232)	LED Indicators	10 x On board LED indicators 1 x Error LED 1 x Power LED 2 x Ethernet Link/Speed 2 x Port A TX/RX 2 x Port B TX/RX 1 x Button A indicator 1 x Button B indicator
Switch B (SWB)	1 x DIP-Switch for serial EIA485 configuration: Position 1: ON: 120 Ω termination active Off: 120 Ω termination inactive Position 2-3: ON: Polarization active Off: Polarization inactive		