

BACnet Server

Midea Comercial & VRF

Gateway for the integration of Midea Air Conditioning into BACnet/IP or BACnet
MSTP control and monitoring systems

USER MANUAL

Issue date: 01/2020 r1.0 ENGLISH

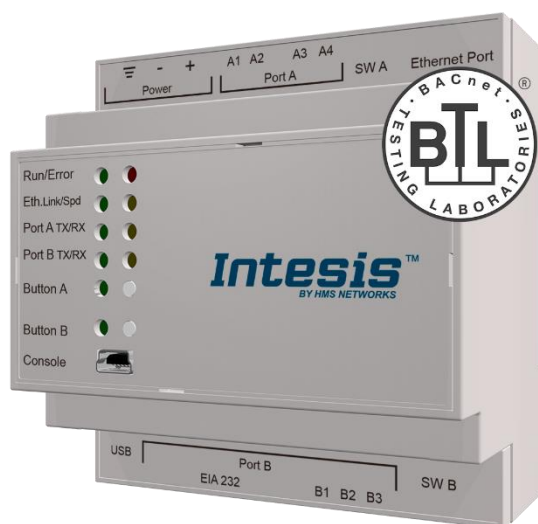

Important User Information

Disclaimer

The information in this document is for informational purposes only. Please inform HMS Industrial Networks of any inaccuracies or omissions found in this document. HMS Industrial Networks disclaims any responsibility or liability for any errors that may appear in this document.

HMS Industrial Networks reserves the right to modify its products in line with its policy of continuous product development. The information in this document shall therefore not be construed as a commitment on the part of HMS Industrial Networks and is subject to change without notice. HMS Industrial Networks makes no commitment to update or keep current the information in this document.

The data, examples and illustrations found in this document are included for illustrative purposes and are only intended to help improve understanding of the functionality and handling of the product. In view of the wide range of possible applications of the product, and because of the many variables and requirements associated with any particular implementation, HMS Industrial Networks cannot assume responsibility or liability for actual use based on the data, examples or illustrations included in this document nor for any damages incurred during installation of the product. Those responsible for the use of the product must acquire sufficient knowledge in order to ensure that the product is used correctly in their specific application and that the application meets all performance and safety requirements including any applicable laws, regulations, codes and standards. Further, HMS Industrial Networks will under no circumstances assume liability or responsibility for any problems that may arise as a result from the use of undocumented features or functional side effects found outside the documented scope of the product. The effects caused by any direct or indirect use of such aspects of the product are undefined and may include e.g. compatibility issues and stability issues.

Gateway for the integration of Midea Air Conditioning into BACnet/IP or BACnet MSTP control and monitoring systems.

ORDER CODE	LEGACY ORDER CODE
INBACMID004I000	MD-AC-BAC-4

INDEX

1	Description	6
1.1	Introduction	6
1.2	Functionality	7
1.3	Capacity of Intesis	7
2	Protocol Implementation Conformance Statement	8
2.1	BACnet Standardized Device Profile (Annex L):	8
2.2	Segmentation Capability:	8
2.3	Data Link Layer Options:	8
2.4	Device Address Binding:	9
2.5	Networking Options:	9
2.6	Character Sets Supported	9
2.7	Gateway	9
3	BACnet Interoperability Building Blocks Supported (BIBBs)	10
3.1	Data Sharing BIBBs	10
3.2	Alarm and Event Management BIBBs	10
3.3	Scheduling BIBBs	10
3.4	Trending BIBBs	11
3.5	Network Management BIBBs	11
3.6	Device Management BIBBs	11
4	Service Types	13
5	Objects	14
5.1	Supported Object Types	14
5.2	Member objects	15
5.2.1	Type: Gateway	15
5.2.2	Type: Central control	15
5.2.3	Type: Indoor Unit	15
5.3	Objects and properties	16
5.3.1	Device INBACMID004I000 (Device Object Type)	16
5.3.2	On/Off (all units) (Binary Output Object Type)	18
5.3.3	Mode (all units) (Multistate Output Object Type)	19
5.3.4	FanSpeed (all units) (Multistate Input Object Type)	20
5.3.5	Vane position (all units) (Binary Output Object Type)	21
5.3.6	Temperature Setpoint (all units) (Analog Output Object Type)	22
5.3.7	Operating mode force (all units) (Binary Output Object Type)	23
5.3.8	Remote control lock (all units) (Binary Output Object Type)	24
5.3.9	Uxx_On/Off_S (Binary Input Object Type)	25
5.3.10	Uxx_On/Off_C (Binary Output Object Type)	26
5.3.11	Uxx_Mode_S (Multistate Input Object Type)	27

5.3.12	Uxx_Mode_C (Multistate Output Object Type)	28
5.3.13	Uxx_Setpoint_S (Analog Input Object Type)	29
5.3.14	Uxx_Setpoint_C (Analog Output Object Type)	30
5.3.15	Uxx_FanSpeed_S (Multistate Input Object Type)	31
5.3.16	Uxx_FanSpeed_C (Multistate Output Object Type)	32
5.3.17	Uxx_Vane position_S (Binary Input Object Type)	33
5.3.18	Uxx_Vane position_C (Binary Output Object Type)	34
5.3.19	Uxx_Room Temperature (Analog Input Object Type)	35
5.3.20	Uxx_Unit Error code (Analog Input Object Type)	36
5.3.21	Uxx_Communication Error IU (Binary Input Object Type)	38
5.3.22	Uxx_Remote control lock_S (Binary Input Object Type)	39
5.3.23	Uxx_Remote control lock_C (Binary Output Object Type)	40
5.3.24	Uxx_Operation mode force_S (Binary Input Object Type)	41
5.3.25	Uxx_Operating mode force_C (Binary Input Object Type)	42
6	Connections	43
6.1	Power device	43
6.2	Connection to BACnet	44
6.2.1	BACnet IP	44
6.2.2	BACnet MSTP	44
6.3	Connect to Midea installation	44
6.4	Connect to the configuration tool	44
7	Set-up process and troubleshooting	45
7.1	Pre-requisites	45
7.2	Intesis MAPS. Configuration & monitoring tool for Intesis BACnet series	45
7.2.1	Introduction	45
7.2.2	Connection	45
7.2.3	Configuration tab	46
7.2.4	BACnet Server configuration	46
7.2.5	Midea configuration	46
7.2.6	Signals	48
7.2.7	Sending the configuration to Intesis	49
7.2.8	Diagnostic	50
7.2.9	Set-up procedure	51
8	Electrical & Mechanical Features	52
9	Dimensions	53
10	Error codes	54

1 Description

1.1 Introduction

This document describes the integration of Midea Comercial & VRF air conditioning systems into BACnet compatible devices and systems using gateway *Intesis BACnet Server – Midea Comercial & VRF*.

The aim of this integration is to monitor and control your Midea air conditioning system, remotely, from your Control Center using any commercial SCADA or monitoring software that includes a BACnet/IP or BACnet MSTP driver. To do it so, Intesis allows BACnet/IP and BACnet MSTP communication, acting as a server (B-AAC profile), allowing polling or subscription requests (COV).

Intesis makes available the Midea Comercial & VRF conditioning system indoor units through independent BACnet objects.

Intesis provides a fixed BACnet object IDs mapping based on Indoor unit addresses. Simple configuration is needed: just select the appropriate communication parameters (IP address, baud rate...).

Up to 4 indoor units supported, depending on product version.

This document assumes that the user is familiar with BACnet and Midea technologies and their technical terms.

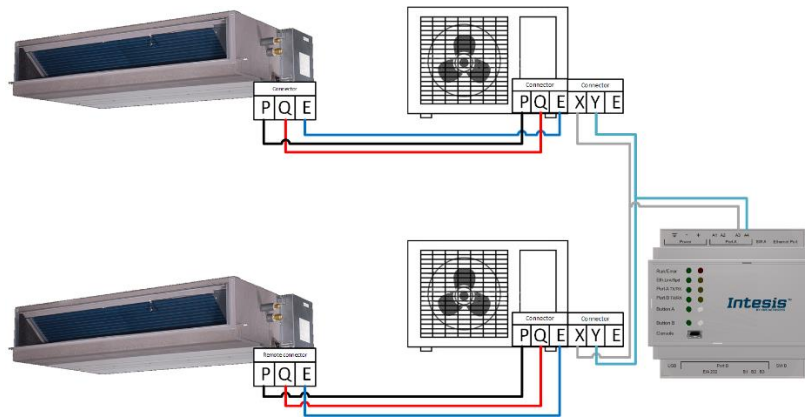

Integration of multiple Midea systems (multiple outdoor units) into BACnet/IP or BACnet MSTP control systems

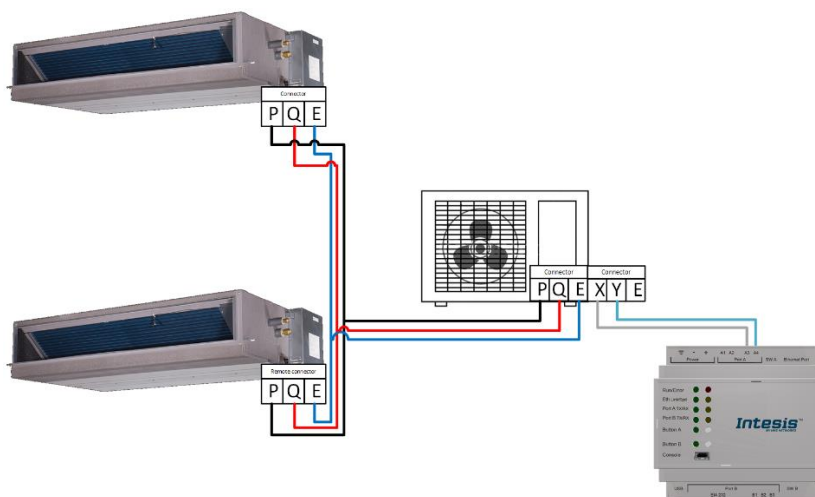

Integration of one Midea system with more than one indoor unit into BACnet/IP or BACnet MSTP control systems

1.2 *Functionality*

Intesis continuously monitors Midea Comercial & VRF network for all configured signals and keeps the updated status of all of them in its memory, ready to be served when requested from the BACnet side.

Commands toward the indoor units are permitted.

Each indoor unit is presented as a set of BACnet objects.

Element	Object supported
General signals (all units)	<ul style="list-style-type: none"> • Command
Indoor Unit	<ul style="list-style-type: none"> • Status • Command • Communication status

1.3 *Capacity of Intesis*

Element	Max.	Notes
Number of indoor units	4	Number of indoor units that can be controlled through Intesis

2 Protocol Implementation Conformance Statement

BACnet Protocol Implementation Conformance Statement (PICS)

Date: 2018-04-20

Vendor Name: HMS Industrial Networks S.L.U

Product Name: Intesis-BACnet-Midea Comercial & VRF

Product Model Number: INBACMID004I000

Application Software Version: 0.0.0.1

Firmware Revision: 14.1.0.0

BACnet Protocol Revision: 14

Product Description:

Midea Comercial & VRF to BACnet Gateway

Abstraction of Midea air conditioning system properties and functionalities as BACnet Objects.
Capacity of 4 indoor units depending on product version.

2.1 BACnet Standardized Device Profile (Annex L):

- BACnet Operator Workstation (B-OWS)
- BACnet Building Controller (B-BC)
- BACnet Advanced Application Controller (B-AAC)
- BACnet Application Specific Controller (B-ASC)
- BACnet Smart Sensor (B-SS)
- BACnet Smart Actuator (B-SA)

Additional BACnet Interoperability Building Blocks Supported (Annex K):
Reference of BIBBs List

2.2 Segmentation Capability:

Segmented request supported No Yes Window Size 16

Segmented responses supported No Yes Window Size 16

2.3 Data Link Layer Options:

- BACnet IP, (Annex J)
- BACnet IP, (Annex J), Foreign Device
- ISO 8802-3, Ethernet (Clause 7)
- ANSI/ATA 878.1, 2.5 Mb. ARCNET (Clause 8)
- ANSI/ATA 878.1, RS-485 ARCNET (Clause 8), baud rate(s) _____
- MS/TP master (Clause 9), baud rate(s): 9600, 19200, 38400, 57600, 76800, 115200
- MS/TP slave (Clause 9), baud rate(s): _____
- Point-To-Point, EIA 232 (Clause 10), baud rate(s): _____
- Point-To-Point, modem, (Clause 10), baud rate(s): _____
- LonTalk, (Clause 11), medium: _____
- Other: _____

2.4 Device Address Binding:

Is static device binding supported? (This is currently necessary for two-way communication with MS/TP slaves and certain other devices.) Yes No

2.5 Networking Options:

- Router, Clause 6 - List all routing configurations, e.g., ARCNET-Ethernet, Ethernet-MS/TP, etc.
- Annex H, BACnet Tunneling Router over IP
- BACnet/IP Broadcast Management Device (BBMD)
Does the BBMD support registrations by Foreign Devices? Yes No

2.6 Character Sets Supported

Indicating support for multiple character sets does not imply that they can all be supported simultaneously.

- ISO 10646 (UTF-8)
- IBM™/Microsoft™ DBCS
- ISO 8859-1
- ISO 10646 (UCS-2)
- ISO 10646 (UCS-4)
- JIS X 0208

2.7 Gateway

If this product is a communication gateway, describe the types of non-BACnet equipment/network(s) that the gateway supports:

Midea Comercial & VRF Air Conditioning Systems

3 BACnet Interoperability Building Blocks Supported (BIBBs)

3.1 Data Sharing BIBBs

BIBB Type		Active	BACnet Service	Initiate	Execute
DS-RP-A	Data Sharing-ReadProperty-A	<input type="checkbox"/>	ReadProperty	<input checked="" type="checkbox"/>	<input type="checkbox"/>
DS-RP-B	Data Sharing-ReadProperty-B	<input checked="" type="checkbox"/>	ReadProperty	<input type="checkbox"/>	<input checked="" type="checkbox"/>
DS-RPM-A	Data Sharing-ReadPropertyMultiple-A	<input type="checkbox"/>	ReadPropertyMultiple	<input checked="" type="checkbox"/>	<input type="checkbox"/>
DS-RPM-B	Data Sharing-ReadPropertyMultiple-B	<input checked="" type="checkbox"/>	ReadPropertyMultiple	<input type="checkbox"/>	<input checked="" type="checkbox"/>
DS-RPC-A	Data Sharing-ReadPropertyConditiona-A	<input type="checkbox"/>	ReadPropertyConditional	<input checked="" type="checkbox"/>	<input type="checkbox"/>
DS-RPC-B	Data Sharing-ReadPropertyConditional-B	<input type="checkbox"/>	ReadPropertyConditional	<input type="checkbox"/>	<input checked="" type="checkbox"/>
DS-WP-A	Data Sharing-WriteProperty-A	<input type="checkbox"/>	WriteProperty	<input checked="" type="checkbox"/>	<input type="checkbox"/>
DS-WP-B	Data Sharing-WriteProperty-B	<input checked="" type="checkbox"/>	WriteProperty	<input type="checkbox"/>	<input checked="" type="checkbox"/>
DS-WPM-A	Data Sharing-WritePropertyMultiple-A	<input type="checkbox"/>	WritePropertyMultiple	<input checked="" type="checkbox"/>	<input type="checkbox"/>
DS-WPM-B	Data Sharing-WritePropertyMultiple-B	<input checked="" type="checkbox"/>	WritePropertyMultiple	<input type="checkbox"/>	<input checked="" type="checkbox"/>
DS-COV-A	Data Sharing-COV-A	<input type="checkbox"/>	SubscribeCOV	<input checked="" type="checkbox"/>	<input type="checkbox"/>
		<input type="checkbox"/>	ConfirmedCOVNotification	<input type="checkbox"/>	<input checked="" type="checkbox"/>
		<input type="checkbox"/>	UnconfirmedCOVNotification	<input type="checkbox"/>	<input checked="" type="checkbox"/>
DS-COV-B	Data Sharing-COV-B	<input checked="" type="checkbox"/>	SubscribeCOV	<input type="checkbox"/>	<input checked="" type="checkbox"/>
		<input checked="" type="checkbox"/>	ConfirmedCOVNotification	<input checked="" type="checkbox"/>	<input type="checkbox"/>
		<input checked="" type="checkbox"/>	UnconfirmedCOVNotification	<input checked="" type="checkbox"/>	<input type="checkbox"/>
DS-COVP-A	Data Sharing-COVP-A	<input type="checkbox"/>	SubscribeCOVProperty	<input checked="" type="checkbox"/>	<input type="checkbox"/>
		<input type="checkbox"/>	ConfirmedCOVNotification	<input type="checkbox"/>	<input checked="" type="checkbox"/>
		<input type="checkbox"/>	UnconfirmedCOVNotification	<input type="checkbox"/>	<input checked="" type="checkbox"/>
DS-COVP-B	Data Sharing-COVP-B	<input type="checkbox"/>	SubscribeCOVProperty	<input type="checkbox"/>	<input checked="" type="checkbox"/>
		<input type="checkbox"/>	ConfirmedCOVNotification	<input checked="" type="checkbox"/>	<input type="checkbox"/>
		<input type="checkbox"/>	UnconfirmedCOVNotification	<input checked="" type="checkbox"/>	<input type="checkbox"/>
DS-COVU-A	Data Sharing-COV-Unsubscribed-A	<input type="checkbox"/>	UnconfirmedCOVNotification	<input type="checkbox"/>	<input checked="" type="checkbox"/>
DS-COVU-B	Data Sharing-COV- Unsubscribed -B	<input type="checkbox"/>	UnconfirmedCOVNotification	<input checked="" type="checkbox"/>	<input type="checkbox"/>

3.2 Alarm and Event Management BIBBs

BIBB Type		Active	BACnet Service	Initiate	Execute
AE-N-A	Alarm and Event-Notification-A	<input type="checkbox"/>	ConfirmedEventNotification	<input type="checkbox"/>	<input checked="" type="checkbox"/>
		<input type="checkbox"/>	UnconfirmedEventNotification	<input type="checkbox"/>	<input checked="" type="checkbox"/>
AE-N-I-B	Alarm and Event-Notification Internal-B	<input checked="" type="checkbox"/>	ConfirmedEventNotification	<input checked="" type="checkbox"/>	<input type="checkbox"/>
		<input checked="" type="checkbox"/>	UnconfirmedEventNotification	<input checked="" type="checkbox"/>	<input type="checkbox"/>
AE-N-E-B	Alarm and Event-Notification External-B	<input type="checkbox"/>	ConfirmedEventNotification	<input checked="" type="checkbox"/>	<input type="checkbox"/>
		<input type="checkbox"/>	UnconfirmedEventNotification	<input checked="" type="checkbox"/>	<input type="checkbox"/>
AE-ACK-A	Alarm and Event-ACK-A	<input type="checkbox"/>	AcknowledgeAlarm	<input checked="" type="checkbox"/>	<input type="checkbox"/>
AE-ACK-B	Alarm and Event-ACK-B	<input checked="" type="checkbox"/>	AcknowledgeAlarm	<input type="checkbox"/>	<input checked="" type="checkbox"/>
AE-ASUM-A	Alarm and Event-Alarm Summary-A	<input type="checkbox"/>	GetAlarmSummary	<input checked="" type="checkbox"/>	<input type="checkbox"/>
AE-ASUM-B	Alarm and Event-Alarm Summary-B	<input checked="" type="checkbox"/>	GetAlarmSummary	<input type="checkbox"/>	<input checked="" type="checkbox"/>
AE-ESUM-A	Alarm and Event-Enrollment Summary-A	<input type="checkbox"/>	GetEnrollmentSummary	<input checked="" type="checkbox"/>	<input type="checkbox"/>
AE-ESUM-B	Alarm and Event-Enrollment Summary-B	<input type="checkbox"/>	GetEnrollmentSummary	<input type="checkbox"/>	<input checked="" type="checkbox"/>
AE-INFO-A	Alarm and Event-Information-A	<input type="checkbox"/>	GetEventInformation	<input checked="" type="checkbox"/>	<input type="checkbox"/>
AE-INFO-B	Alarm and Event-Information-B	<input checked="" type="checkbox"/>	GetEventInformation	<input type="checkbox"/>	<input checked="" type="checkbox"/>
AE-LS-A	Alarm and Event-LifeSafety-A	<input type="checkbox"/>	LifeSafetyOperation	<input checked="" type="checkbox"/>	<input type="checkbox"/>
AE-LS-B	Alarm and Event-LifeSafety-B	<input type="checkbox"/>	LifeSafetyOperation	<input type="checkbox"/>	<input checked="" type="checkbox"/>

3.3 Scheduling BIBBs

BIBB Type		Active	BACnet Service	Initiate	Execute
SCHED-A	Scheduling-A (must support DS-RP-A and DS-WP-A)	<input type="checkbox"/>			
SCHED-I-B	Scheduling-Internal-B (shall support DS-RP-B and DS-WP-B) (shall also support either DM-TS-B or DS-UTC-B)	<input checked="" type="checkbox"/>			
SCHED-E-B	Scheduling-External-B (shall support SCHED-I-B and DS-WP-A)	<input type="checkbox"/>			

3.4 Trending BIBBs

BIBB Type		Active	BACnet Service	Initiate	Execute
T-VMT-A	Trending - Viewing and Modifying Trends–A	<input type="checkbox"/>	ReadRange	<input checked="" type="checkbox"/>	<input type="checkbox"/>
T-VMT-I-B	Trending - Viewing and Modifying Trends Inernal–B	<input checked="" type="checkbox"/>	ReadRange	<input type="checkbox"/>	<input checked="" type="checkbox"/>
T-VMT-E-B	Trending - Viewing and Modifying Trends External–B	<input type="checkbox"/>	ReadRange	<input type="checkbox"/>	<input checked="" type="checkbox"/>
T-ATR-A	Trending - Automated Trend Retrieval–A	<input type="checkbox"/>	ConfirmedEventNotification	<input type="checkbox"/>	<input checked="" type="checkbox"/>
		<input type="checkbox"/>	ReadRange	<input checked="" type="checkbox"/>	<input type="checkbox"/>
T-ATR-B	Trending - Automated Trend Retrieval–B	<input checked="" type="checkbox"/>	ConfirmedEventNotification	<input checked="" type="checkbox"/>	<input type="checkbox"/>
		<input checked="" type="checkbox"/>	ReadRange	<input type="checkbox"/>	<input checked="" type="checkbox"/>

3.5 Network Management BIBBs

BIBB Type		Active	BACnet Service	Initiate	Execute
NM-CE-A	Network Management - Connection Establishment–A	<input type="checkbox"/>	Establish-Connection-To-Network	<input checked="" type="checkbox"/>	<input type="checkbox"/>
		<input type="checkbox"/>	Disconnect-Connection-To-Network	<input checked="" type="checkbox"/>	<input type="checkbox"/>
NM-CE-B	Network Management - Connection Establishment– B	<input type="checkbox"/>	Establish-Connection-To-Network	<input type="checkbox"/>	<input checked="" type="checkbox"/>
		<input type="checkbox"/>	Disconnect-Connection-To-Network	<input type="checkbox"/>	<input checked="" type="checkbox"/>
NM-RC-A	Network Management - Router Configuration–A	<input type="checkbox"/>	Who-Is-Router-To-Network	<input checked="" type="checkbox"/>	<input type="checkbox"/>
		<input type="checkbox"/>	I-Am-Router-To-Network	<input type="checkbox"/>	<input checked="" type="checkbox"/>
		<input type="checkbox"/>	I-Could-Be-Router-To-Network	<input type="checkbox"/>	<input checked="" type="checkbox"/>
		<input type="checkbox"/>	Initialize-Routing-Table	<input checked="" type="checkbox"/>	<input type="checkbox"/>
		<input type="checkbox"/>	Initialize-Routing-Table-Ack	<input type="checkbox"/>	<input checked="" type="checkbox"/>
NM-RC-B	Network Management - Router Configuration–B	<input type="checkbox"/>	Who-Is-Router-To-Network	<input checked="" type="checkbox"/>	<input checked="" type="checkbox"/>
		<input type="checkbox"/>	I-Am-Router-To-Network	<input checked="" type="checkbox"/>	<input checked="" type="checkbox"/>
		<input type="checkbox"/>	Initialize-Routing-Table	<input type="checkbox"/>	<input checked="" type="checkbox"/>
		<input type="checkbox"/>	Initialize-Routing-Table-Ack	<input checked="" type="checkbox"/>	<input type="checkbox"/>

3.6 Device Management BIBBs

BIBB Type		Active	BACnet Service	Initiate	Execute
DM-DDB-A	Device Management - Dynamic Device Binding–A	<input checked="" type="checkbox"/>	Who-Is	<input checked="" type="checkbox"/>	<input type="checkbox"/>
		<input checked="" type="checkbox"/>	I-Am	<input type="checkbox"/>	<input checked="" type="checkbox"/>
DM-DDB-B	Device Management - Dynamic Device Binding–B	<input checked="" type="checkbox"/>	Who-Is	<input type="checkbox"/>	<input checked="" type="checkbox"/>
		<input checked="" type="checkbox"/>	I-Am	<input checked="" type="checkbox"/>	<input type="checkbox"/>
DM-DOB-A	Device Management - Dynamic Object Binding–A	<input type="checkbox"/>	Who-Has	<input checked="" type="checkbox"/>	<input type="checkbox"/>
		<input type="checkbox"/>	I-Have	<input type="checkbox"/>	<input checked="" type="checkbox"/>
DM-DOB-B	Device Management - Dynamic Object Binding–B	<input checked="" type="checkbox"/>	Who-Has	<input type="checkbox"/>	<input checked="" type="checkbox"/>
		<input checked="" type="checkbox"/>	I-Have	<input checked="" type="checkbox"/>	<input type="checkbox"/>
DM-DCC-A	Device Management - DeviceCommunicationControl–A	<input type="checkbox"/>	DeviceCommunicationControl	<input checked="" type="checkbox"/>	<input type="checkbox"/>
DM-DCC-B	Device Management - DeviceCommunicationControl–B	<input checked="" type="checkbox"/>	DeviceCommunicationControl	<input type="checkbox"/>	<input checked="" type="checkbox"/>
DM-PT-A	Device Management - PrivateTransfer–A	<input type="checkbox"/>	ConfirmedPrivateTransfer	<input checked="" type="checkbox"/>	<input type="checkbox"/>
		<input type="checkbox"/>	UnconfirmedPrivateTransfer	<input checked="" type="checkbox"/>	<input type="checkbox"/>
DM-PT-B	Device Management - PrivateTransfer–B	<input type="checkbox"/>	ConfirmedPrivateTransfer	<input type="checkbox"/>	<input checked="" type="checkbox"/>
		<input type="checkbox"/>	UnconfirmedPrivateTransfer	<input type="checkbox"/>	<input checked="" type="checkbox"/>
DM-TM-A	Device Management - Text Message–A	<input type="checkbox"/>	ConfirmedTextMessage	<input checked="" type="checkbox"/>	<input type="checkbox"/>
		<input type="checkbox"/>	UnconfirmedTextMessage	<input checked="" type="checkbox"/>	<input type="checkbox"/>
DM-TM-B	Device Management - Text Message–B	<input type="checkbox"/>	ConfirmedTextMessage	<input type="checkbox"/>	<input checked="" type="checkbox"/>
		<input type="checkbox"/>	UnconfirmedTextMessage	<input type="checkbox"/>	<input checked="" type="checkbox"/>
DM-TS-A	Device Management - TimeSynchronization–A	<input type="checkbox"/>	TimeSynchronization	<input checked="" type="checkbox"/>	<input type="checkbox"/>
DM-TS-B	Device Management - TimeSynchronization–B	<input checked="" type="checkbox"/>	TimeSynchronization	<input type="checkbox"/>	<input checked="" type="checkbox"/>
DM-UTC-A	Device Management - UTCTimeSynchronization–A	<input type="checkbox"/>	UTCTimeSynchronization	<input checked="" type="checkbox"/>	<input type="checkbox"/>
DM-UTC-B	Device Management - UTCTimeSynchronization–B	<input type="checkbox"/>	UTCTimeSynchronization	<input type="checkbox"/>	<input checked="" type="checkbox"/>
DM-RD-A	Device Management - ReinitializeDevice–A	<input type="checkbox"/>	ReinitializeDevice	<input checked="" type="checkbox"/>	<input type="checkbox"/>
DM-RD-B	Device Management - ReinitializeDevice–B	<input checked="" type="checkbox"/>	ReinitializeDevice	<input type="checkbox"/>	<input checked="" type="checkbox"/>
DM-BR-A	Device Management - Backup and Restore–A	<input type="checkbox"/>	AtomicReadFile	<input checked="" type="checkbox"/>	<input type="checkbox"/>

		<input type="checkbox"/>	AtomicWriteFile	<input checked="" type="checkbox"/>	<input type="checkbox"/>
		<input type="checkbox"/>	CreateObject	<input checked="" type="checkbox"/>	<input type="checkbox"/>
		<input type="checkbox"/>	ReinitializeDevice	<input checked="" type="checkbox"/>	<input type="checkbox"/>
DM-BR-B	Device Management - Backup and Restore–B	<input type="checkbox"/>	AtomicReadFile	<input type="checkbox"/>	<input checked="" type="checkbox"/>
		<input type="checkbox"/>	AtomicWriteFile	<input type="checkbox"/>	<input checked="" type="checkbox"/>
		<input type="checkbox"/>	ReinitializeDevice	<input type="checkbox"/>	<input checked="" type="checkbox"/>
DM-R-A	Device Management - Restart–A	<input type="checkbox"/>	UnconfirmedCOVNotification	<input type="checkbox"/>	<input checked="" type="checkbox"/>
DM-R-B	Device Management - Restart–B	<input type="checkbox"/>	UnconfirmedCOVNotification	<input checked="" type="checkbox"/>	<input type="checkbox"/>
DM-LM-A	Device Management - List Manipulation–A	<input type="checkbox"/>	AddListElement	<input checked="" type="checkbox"/>	<input type="checkbox"/>
		<input type="checkbox"/>	RemoveListElement	<input checked="" type="checkbox"/>	<input type="checkbox"/>
DM-LM-B	Device Management - List Manipulation–B	<input type="checkbox"/>	AddListElement	<input type="checkbox"/>	<input checked="" type="checkbox"/>
		<input type="checkbox"/>	RemoveListElement	<input type="checkbox"/>	<input checked="" type="checkbox"/>
DM-OCD-A	Device Management - Object Creation and Deletion–A	<input type="checkbox"/>	CreateObject	<input checked="" type="checkbox"/>	<input type="checkbox"/>
		<input type="checkbox"/>	DeleteObject	<input checked="" type="checkbox"/>	<input type="checkbox"/>
DM-OCD-B	Device Management - Object Creation and Deletion–B	<input type="checkbox"/>	CreateObject	<input type="checkbox"/>	<input checked="" type="checkbox"/>
		<input type="checkbox"/>	DeleteObject	<input type="checkbox"/>	<input checked="" type="checkbox"/>
DM-VT-A	Device Management - Virtual Terminal–A	<input type="checkbox"/>	VT-Open	<input checked="" type="checkbox"/>	<input type="checkbox"/>
		<input type="checkbox"/>	VT-Close	<input checked="" type="checkbox"/>	<input checked="" type="checkbox"/>
		<input type="checkbox"/>	VT-Data	<input checked="" type="checkbox"/>	<input checked="" type="checkbox"/>
DM-VT-B	Device Management - Virtual Terminal–B	<input type="checkbox"/>	VT-Open	<input type="checkbox"/>	<input checked="" type="checkbox"/>
		<input type="checkbox"/>	VT-Close	<input checked="" type="checkbox"/>	<input checked="" type="checkbox"/>
		<input type="checkbox"/>	VT-Data	<input checked="" type="checkbox"/>	<input checked="" type="checkbox"/>

4 Service Types

Service type	Service name	Supported	Remarks
Alarm and Event Services	AcknowledgeAlarm	<input checked="" type="checkbox"/>	
	ConfirmedCOVNotification	<input type="checkbox"/>	
	ConfirmedEventNotification	<input type="checkbox"/>	
	GetAlarmSummary	<input checked="" type="checkbox"/>	
	GetEnrollmentSummary	<input type="checkbox"/>	
	SubscribeCOV	<input checked="" type="checkbox"/>	
File Access Services	AtomicReadFile	<input type="checkbox"/>	
	AtomicWriteFile	<input type="checkbox"/>	
Object Access Services	AddListElement	<input type="checkbox"/>	
	RemoveListElement	<input type="checkbox"/>	
	CreateObject	<input type="checkbox"/>	
	DeleteObject	<input type="checkbox"/>	
	ReadProperty	<input checked="" type="checkbox"/>	
	ReadPropertyConditional	<input type="checkbox"/>	
	ReadPropertyMultiple	<input checked="" type="checkbox"/>	
	ReadRange	<input checked="" type="checkbox"/>	
	WriteProperty	<input checked="" type="checkbox"/>	
	WritePropertyMultiple	<input checked="" type="checkbox"/>	
Remote Device Management Services	DeviceCommunicationControl	<input checked="" type="checkbox"/>	
	ConfirmedPrivateTransfer	<input type="checkbox"/>	
	ConfirmedTextMessage	<input type="checkbox"/>	
	ReinitializeDevice	<input checked="" type="checkbox"/>	
Virtual Terminal Services	VtOpen	<input type="checkbox"/>	
	VtClose	<input type="checkbox"/>	
	VtData	<input type="checkbox"/>	
Security Services	Authenticate	<input type="checkbox"/>	
	RequestKey	<input type="checkbox"/>	
Unconfirmed Services	I-Am	<input checked="" type="checkbox"/>	
	I-Have	<input type="checkbox"/>	
	UnconfirmedCOVNotification	<input type="checkbox"/>	
	UnconfirmedEventNotification	<input type="checkbox"/>	
	UnconfirmedPrivateTransfer	<input type="checkbox"/>	
	UnconfirmedTextMessage	<input type="checkbox"/>	
	TimeSynchronization	<input checked="" type="checkbox"/>	
	UtcTimeSynchronization	<input type="checkbox"/>	
	Who-Has	<input checked="" type="checkbox"/>	
	Who-Is	<input checked="" type="checkbox"/>	
	LifeSafetyOperation	<input type="checkbox"/>	
	SubscribeCOVProperty	<input type="checkbox"/>	
	GetEventInformation	<input checked="" type="checkbox"/>	

5 Objects

5.1 Supported Object Types

Objects supported are shown in the table below.

Object Type	ID	Supported	Management Point
Analog-Input	0	<input checked="" type="checkbox"/>	Uxx_Setpoint_S Uxx_Room Temperature Uxx_Unit Error Code
Analog-Output	1	<input checked="" type="checkbox"/>	Temperature Setpoint (all units) Uxx_Setpoint_C
Analog-Value	2	<input type="checkbox"/>	
Averaging	18	<input type="checkbox"/>	
Binary-Input	3	<input checked="" type="checkbox"/>	Uxx_On/Off_S Uxx_Vane position_S Uxx_Communication Error IU Uxx_Remote control lock_S Uxx_Operating mode force_S
Binary-Output	4	<input checked="" type="checkbox"/>	On/Off (all units) Vane Position (all units) Operating mode force (all units) Remote control lock (all units) Uxx_On/Off_C Uxx_Vane position_C Uxx_Remote control lock_C Uxx_Operating mode force_C
Binary-Value	5	<input type="checkbox"/>	
Calendar	6	<input type="checkbox"/>	
Command	7	<input type="checkbox"/>	
Device	8	<input checked="" type="checkbox"/>	Device INBACMID004I000
Event-Enrollment	9	<input type="checkbox"/>	
File	10	<input type="checkbox"/>	
Group	11	<input type="checkbox"/>	
Life-Safety-Point	21	<input type="checkbox"/>	
Life-Safety-Zone	22	<input type="checkbox"/>	
Loop	12	<input type="checkbox"/>	
Multistate-Input	13	<input checked="" type="checkbox"/>	Uxx_Mode_S Uxx_FanSpeed_S
Multistate-Output	14	<input checked="" type="checkbox"/>	Mode (all units) FanSpeed (all units) Uxx_Mode_C UxxFanSpeed_C
Multistate-Value	19	<input type="checkbox"/>	
Notification-Class	15	<input checked="" type="checkbox"/>	
Program	16	<input type="checkbox"/>	
Schedule	17	<input checked="" type="checkbox"/>	
Trend-Log	20	<input checked="" type="checkbox"/>	
Trend-Log-Multiple	27	<input checked="" type="checkbox"/>	

5.2 Member objects

5.2.1 Type: Gateway

Object-name	Description	Object-type	Object-instance
Device INBACMID004I000	Midea Comercial & VRF to BACnet Gateway	Device	246 <i>Instance number of device object can be configured with MAPS</i>

5.2.2 Type: Central control

Object-name	Description	Object-type	Object-instance
On/Off (all units)	0-Off,1-On	BO	0
Mode (all units)	1-Heat,2-Cool,3-Fan,4-Dry,5-Auto	MO	0
FanSpeed (all units)	1-Auto,2-Low,3-Mid,4-High	MO	1
Vane Position (all units)	0-Swing Off, 1-Swing On	BO	1
Temperature Setpoint (all units)	17..30 °C / 62...88 °F	AO	0
Operating mode force (all units)	0-No force, 1-force	BO	2
Remote control lock (all units)	0-Unlock, 1-Lock	BO	3

5.2.3 Type: Indoor Unit

Uxx is a generic prefix for the BACnet object name, where:

Variable	Description
"Uxx"	Indoor Unit address (1...64)

Object-name	Description	Object-type	Object-instance
Uxx_On/Off_S	0-Off,1-On	BI	(xxx *100) + 0, Where xxx is the unit index in MAPS (1...4)
Uxx_On/Off_C	0-Off,1-On	BO	(xxx *100) + 0
Uxx_Mode_S	1-Heat,2-Cool,3-Fan,4-Dry,5-Auto	MI	(xxx *100) + 0
Uxx_Mode_C	1-Heat,2-Cool,3-Fan,4-Dry,5-Auto	MO	(xxx *100) + 0
Uxx_Setpoint_S	17...30 °C / 62...88 °F	AI	(xxx *100) + 0
Uxx_Setpoint_C	17...30 °C / 62...88 °F	AO	(xxx *100) + 0
Uxx_FanSpeed_S	1-Auto,2-Low,3-Med,4-High	MI	(xxx *100) + 1
Uxx_FanSpeed_C	1-Auto,2-Low,3-Med,4-High	MO	(xxx *100) + 1
Uxx_Vane position_S	0-Swing Off,1-Swing On	BI	(xxx *100) + 1
Uxx_Vane position_C	0-Swing Off,1-Swing On	BO	(xxx *100) + 1
Uxx_Room Temperature	-20...100°C / -4...212 °F	AI	(xxx *100) + 1
Uxx_Unit Error Code	0-No error, X-Error (0...255)	AI	(xxx *100) + 2
Uxx_Communication Error IU	0-No error, 1-Error	BI	(xxx *100) + 2
Uxx_Remote control lock_S	0-Unlock,1-Lock	BI	(xxx *100) + 3
Uxx_Remote control lock_C	0-Unlock,1-Lock	BO	(xxx *100) + 2
Uxx_Operating mode force_S	0-No force,1-Force	BI	(xxx *100) + 4
Uxx_Operating mode force_C	0-No force,1-Force	BO	(xxx *100) + 3

5.3 Objects and properties

5.3.1 Device INBACMID004I000 (Device Object Type)

Property Identifier	Property Datatype	Value	ASHRAE	IBOX
Object_Identifier**	BACnetObjectIdentifier	(Device, 246)	R	R
Object_Name**	CharacterString	"Device INBACMID004I000"	R	R
Object_Type	BACnetObjectType	DEVICE (8) (Device Object Type)	R	R
System_Status	BACnetDeviceStatus	OPERATIONAL (0)	R	R
Vendor_Name	CharacterString	"HMS Industrial Networks SLU"	R	R
Vendor_Identifier	Unsigned16	246	R	R
Model_Name	CharacterString	"INBACMID004I000"	R	R
Firmware_Revision	CharacterString	"14.1.0.0"	R	R
Application_Software_Version	CharacterString	"0.0.0.1"	R	R
Location	CharacterString	""	O	-
Description	CharacterString	"MIDEA to BACnet Gateway"	O	R
Protocol_Version	Unsigned	1	R	R
Protocol_Revision	Unsigned	14	R	R
Protocol_Services_Supported	BACnetServiceSupported	Refer to section 4 [Service Types]	R	R
Protocol_Object_Types_Supported	BACnetObjectTypes Supported	Refer to section 5.1 [Object Types]	R	R
Object_List	BACnetArray[N] of BACnetObjectIdentifier	BACnetARRAY[N]	R	R
Structured_Object_List	BACnetArray[N] of BACnetObjectIdentifier	-	O	-
Max_APDU_Length_Accepted	Unsigned	480 when MSTP / 1476 when BACnet/IP	R	R
Segmentation_Supported	BACnetSegmentation	SEGMENTED-BOTH (0)	R	R
Max_Segments_accepted	Unsigned	16	O	R
VT_Classes_Supported	List of BACnetVTClass	-	O	-
Active_VT_Sessions	List of BACnetVTSession	-	O	-
Local_Date	Date	Current date	O	R
Local_Time	Time	Current time	O	R
UTC_Offset	INTEGER	-	O	-
Daylight_Savings_Status	BOOLEAN	-	O	-
APDU_Segment_Timeout	Unsigned	3000	R	R
APDU_Timeout	Unsigned	3000	R	R
Number_of_APDU_Retries	Unsigned	3	R	R
List_Of_Session_Keys	List of BACnetSessionKey	-	O	-
Time_Synchronization_Recipients	List of BACnetRecipient	-	O	-

Max_Master * **	Unsigned	127	R	W
Max_Info_Frames *	Unsigned	1	O	R
Device_Address_Binding	List of BACnetAddressBinding	NULL (empty)	R	R
Database_Revision	Unsigned	0	R	R
Configuration_Files	BACnetArray[N] of BACnetObjectIdentifier	-	O	-
Last_Restore_Time	BACnetTimeStamp	-	O	-
Backup_Failure_Timeout	Unsigned16	-	O	-
Active_COV_Subscriptions	List of BACnetCOVSubscription	List of BACnetCOVSubscription	O	R
Slave_Proxy_Enable	BACnetArray[N] of BOOLEAN	-	O	-
Manual_Slave_Address_Binding	List of BACnetAddressBinding	-	O	-
Auto_Slave_Discovery	BACnetArray[N] of BOOLEAN	-	O	-
Slave_Address_Binding	BACnetAddressBinding	-	O	-
Last_Restart_Reason	BACnetRestartReason	-	O	-
Time_Of_Device_Restart	BACnetTimeStamp	-	O	-
Restart_Notification_Recipients	List of BACnetRecipient	-	O	-
UTC_Time_Synchronization_Recipients	List of BACnetRecipient	-	O	-
Time_Synchronization_Interval	Unsigned	-	O	-
Align_Intervals	BOOLEAN	-	O	-
Interval_Offset	Unsigned	-	O	-
Profile_Name	CharacterString	-	O	-

* Only available when MSTP is used

** Configurable through the configuration tool.

5.3.2 On/Off (all units) (Binary Output Object Type)

It sets all the indoor units On or Off.

Property Identifier	Property Datatype	Value	ASHRAE	IBOX
Object_Identifier	BACnetObjectIdentifier	(Binary Output, 0)	R	R
Object_Name	CharacterString	<i>On/Off (all units)</i>	R	R
Object_Type	BACnetObjectType	BINARY_OUTPUT (4)	R	R
Present_Value	BACnetBinaryPV	INACTIVE (0) / ACTIVE (1)	W	W
Description	CharacterString	-	O	-
Device_Type	CharacterString	-	O	-
Status_Flags	BACnetStatusFlags	{FALSE, FALSE, FALSE, FALSE}	R	R
Event_State	BACnetEventState	STATE_NORMAL (0)	R	R
Reliability	BACnetReliability	NO_FAULT_DETECTED (0)	O	R
Out_Of_Service	BOOLEAN	FALSE	R	R
Polarity	BACnetPolarity	NORMAL (0)	R	R
Inactive_Text	CharacterString	<i>"Off"</i>	O	R
Active_Text	CharacterString	<i>"On"</i>	O	R
Change_Of_State_Time	BACnetDatetime	-	O	R
Change_Of_State_Count	Unsigned	-	O	R
Time_Of_State_Count_Reset	BACnetDatetime	-	O	R
Elapsed_Active_Time	Unsigned	-	O	R
Time_Of_Active_Time_Reset	BACnetDatetime	-	O	R
Minimum_Off_Time	Unsigned32	-	O	-
Minimum_On_Time	Unsigned32	-	O	-
Priority_Array	BACnetPriorityArray	BACnetPriorityArray	R	R
Relinquish_Default	BACnetBinaryPV	INACTIVE (0)	R	R
Time_Delay	Unsigned	-	O	R*
Notification_Class	Unsigned	-	O	R*
Feedback_Value	BACnetBinaryPV	-	O	W
Event_Enable	BACnetEventTransitionBits	-	O	R*
Acked_Transitions	BACnetEventTransitionBits	-	O	R*
Notify_Type	BACnetNotifyType	-	O	R*
Event_Time_Stamps	BACnetArray[N] of BACnetTimeStamp	-	O	R*
Profile_Name	CharacterString	-	O	-

* Only available when specific object has a Notification Class configured

5.3.3 Mode (all units) (Multistate Output Object Type)

It sets the mode over all the indoor units.

Property Identifier	Property Datatype	Value	ASHRAE	IBOX
Object_Identifier	BACnetObjectIdentifier	(Multi-state Output, 0)	R	R
Object_Name	CharacterString	<i>Mode (all units)</i>	R	R
Object_Type	BACnetObjectType	MULTISTATE_OUTPUT (14)	R	R
Present_Value	Unsigned	x	W	W
Description	CharacterString	-	O	-
Device_Type	CharacterString	-	O	-
Status_Flags	BACnetStatusFlags	{FALSE, FALSE, FALSE, FALSE}	R	R
Event_State	BACnetEventState	STATE_NORMAL (0)	R	R
Reliability	BACnetReliability	NO_FAULT_DETECTED (0)	O	R
Out_Of_Service	BOOLEAN	FALSE	R	R
Number_Of_States	Unsigned	5	R	R
State_Text	BACnetArray[N] of CharacterString	<i>Check Mode (all units) table below</i>	O	R
Priority_Array	BACnetPriorityArray	BACnetPriorityArray	R	R
Relinquish_Default	Unsigned	1	R	R
Time_Delay	Unsigned	-	O	R*
Notification_Class	Unsigned	-	O	R*
Feedback_Value	Unsigned	-	O	W
Event_Enable	BACnetEventTransitionBits	-	O	R*
Acked_Transitions	BACnetEventTransitionBits	-	O	R*
Notify_Type	BACnetNotifyType	-	O	R*
Event_Time_Stamps	BACnetArray[N] of BACnetTimeStamp	-	O	R*
Profile_Name	CharacterString	-	O	-

* Only available when specific object has a Notification Class configured

Mode (all units) table

Mode interpretation is possible using the value in the following correspondence table.

Present_Value	Contents displayed in State_Text
1	Heat
2	Cool
3	Fan
4	Dry
5	Auto

5.3.4 FanSpeed (all units) (Multistate Input Object Type)

It sets the fan speed for all the indoor units.

Property Identifier	Property Datatype	Value	ASHRAE	IBOX
Object_Identifier	BACnetObjectIdentifier	(Multi-state Output, 1)	R	R
Object_Name	CharacterString	<i>FanSpeed (all units)</i>	R	R
Object_Type	BACnetObjectType	MULTISTATE_OUTPUT (14)	R	R
Present_Value	Unsigned	x	W	W
Description	CharacterString	-	O	-
Device_Type	CharacterString	-	O	-
Status_Flags	BACnetStatusFlags	{FALSE, FALSE, FALSE, FALSE}	R	R
Event_State	BACnetEventState	STATE_NORMAL (0)	R	R
Reliability	BACnetReliability	NO_FAULT_DETECTED (0)	O	R
Out_Of_Service	BOOLEAN	FALSE	R	R
Number_Of_States	Unsigned	4	R	R
State_Text	BACnetArray[N] of CharacterString	<i>Check FanSpeed (all units) table below</i>	O	R
Priority_Array	BACnetPriorityArray	BACnetPriorityArray	R	R
Relinquish_Default	Unsigned	1	R	R
Time_Delay	Unsigned	-	O	R*
Notification_Class	Unsigned	-	O	R*
Feedback_Value	Unsigned	-	O	W
Event_Enable	BACnetEventTransitionBits	-	O	R*
Acked_Transitions	BACnetEventTransitionBits	-	O	R*
Notify_Type	BACnetNotifyType	-	O	R*
Event_Time_Stamps	BACnetArray[N] of BACnetTimeStamp	-	O	R*
Profile_Name	CharacterString	-	O	-

* Only available when specific object has a Notification Class configured

FanSpeed (all units) table

FanSpeed interpretation is possible using the value in the following correspondence table.

Present_Value	Contents displayed in State_Text
1	Auto
2	Low
3	Mid
4	High

5.3.5 Vane position (all units) (Binary Output Object Type)

It sets the vane position for all the indoor units.

Property Identifier	Property Datatype	Value	ASHRAE	IBOX
Object_Identifier	BACnetObjectIdentifier	(Binary Output, 1)	R	R
Object_Name	CharacterString	<i>Vane position (all units)</i>	R	R
Object_Type	BACnetObjectType	BINARY_OUTPUT (4)	R	R
Present_Value	BACnetBinaryPV	INACTIVE (0) / ACTIVE (1)	W	W
Description	CharacterString	-	O	-
Device_Type	CharacterString	-	O	-
Status_Flags	BACnetStatusFlags	{FALSE, FALSE, FALSE, FALSE}	R	R
Event_State	BACnetEventState	STATE_NORMAL (0)	R	R
Reliability	BACnetReliability	NO_FAULT_DETECTED (0)	O	R
Out_Of_Service	BOOLEAN	FALSE	R	R
Polarity	BACnetPolarity	NORMAL (0)	R	R
Inactive_Text	CharacterString	<i>"Swing Off"</i>	O	R
Active_Text	CharacterString	<i>"Swing On"</i>	O	R
Change_Of_State_Time	BACnetDatetime	-	O	R
Change_Of_State_Count	Unsigned	-	O	R
Time_Of_State_Count_Reset	BACnetDatetime	-	O	R
Elapsed_Active_Time	Unsigned	-	O	R
Time_Of_Active_Time_Reset	BACnetDatetime	-	O	R
Minimum_Off_Time	Unsigned32	-	O	-
Minimum_On_Time	Unsigned32	-	O	-
Priority_Array	BACnetPriorityArray	BACnetPriorityArray	R	R
Relinquish_Default	BACnetBinaryPV	INACTIVE (0)	R	R
Time_Delay	Unsigned	-	O	R*
Notification_Class	Unsigned	-	O	R*
Feedback_Value	BACnetBinaryPV	-	O	W
Event_Enable	BACnetEventTransitionBits	-	O	R*
Acked_Transitions	BACnetEventTransitionBits	-	O	R*
Notify_Type	BACnetNotifyType	-	O	R*
Event_Time_Stamps	BACnetArray[N] of BACnetTimeStamp	-	O	R*
Profile_Name	CharacterString	-	O	-

* Only available when specific object has a Notification Class configured

5.3.6 Temperature Setpoint (all units) (Analog Output Object Type)

It sets the setpoint for all the indoor units.

Property Identifier	Property Datatype	Value	ASHRAE	IBOX
Object_Identifier	BACnetObjectIdentifier	(Analog Output, 0)	R	R
Object_Name	CharacterString	<i>Temperature Setpoint (all units)</i>	R	R
Object_Type	BACnetObjectType	ANALOG_OUTPUT (1)	R	R
Present_Value	REAL	x	W	W
Description	CharacterString	-	O	-
Device_Type	CharacterString	-	O	-
Status_Flags	BACnetStatusFlags	{FALSE, FALSE, FALSE, FALSE}	R	R
Event_State	BACnetEventState	STATE_NORMAL (0)	R	R
Reliability	BACnetReliability	NO_FAULT_DETECTED (0)	O	R
Out_Of_Service	BOOLEAN	FALSE	R	R
Update_Interval	Unsigned	-	O	-
Units	BACnetEngineeringUnits	<i>degrees_Celsius</i>	R	R
Min_Pres_Value	REAL	-	O	-
Max_Pres_Value	REAL	-	O	-
Resolution	REAL	-	O	-
COV_Increment	REAL	0	O	R
Priority_Array	BACnetPriorityArray	BACnetPriorityArray	R	R
Relinquish_Default	Unsigned	<i>Configurable through BACnet and Config Tool</i>	R	R
Time_Delay	Unsigned	-	O	R*
Notification_Class	Unsigned	-	O	R*
High_Limit	REAL	-	O	R*
Low_Limit	REAL	-	O	R*
Deadband	REAL	-	O	R*
Limit_Enable	BACnetLimitEnable	-	O	R*
Event_Enable	BACnetEventTransitionBits	-	O	R*
Acked_Transitions	BACnetEventTransitionBits	-	O	R*
Notify_Type	BACnetNotifyType	-	O	R*
Event_Time_Stamps	BACnetArray[N] of BACnetTimeStamp	-	O	R*
Profile_Name	CharacterString	-	O	-

* Only available when specific object has a Notification Class configured

5.3.7 Operating mode force (all units) (Binary Output Object Type)

It sets the operating mode force for all the indoor units.

Property Identifier	Property Datatype	Value	ASHRAE	IBOX
Object_Identifier	BACnetObjectIdentifier	(Binary Output, 2)	R	R
Object_Name	CharacterString	<i>Operating mode force (all units)</i>	R	R
Object_Type	BACnetObjectType	BINARY_OUTPUT (4)	R	R
Present_Value	BACnetBinaryPV	INACTIVE (0) / ACTIVE (1)	W	W
Description	CharacterString	-	O	-
Device_Type	CharacterString	-	O	-
Status_Flags	BACnetStatusFlags	{FALSE, FALSE, FALSE, FALSE}	R	R
Event_State	BACnetEventState	STATE_NORMAL (0)	R	R
Reliability	BACnetReliability	NO_FAULT_DETECTED (0)	O	R
Out_Of_Service	BOOLEAN	FALSE	R	R
Polarity	BACnetPolarity	NORMAL (0)	R	R
Inactive_Text	CharacterString	<i>"No force"</i>	O	R
Active_Text	CharacterString	<i>"Force"</i>	O	R
Change_Of_State_Time	BACnetDatetime	-	O	R
Change_Of_State_Count	Unsigned	-	O	R
Time_Of_State_Count_Reset	BACnetDatetime	-	O	R
Elapsed_Active_Time	Unsigned	-	O	R
Time_Of_Active_Time_Reset	BACnetDatetime	-	O	R
Minimum_Off_Time	Unsigned32	-	O	-
Minimum_On_Time	Unsigned32	-	O	-
Priority_Array	BACnetPriorityArray	BACnetPriorityArray	R	R
Relinquish_Default	BACnetBinaryPV	INACTIVE (0)	R	R
Time_Delay	Unsigned	-	O	R*
Notification_Class	Unsigned	-	O	R*
Feedback_Value	BACnetBinaryPV	-	O	W
Event_Enable	BACnetEventTransitionBits	-	O	R*
Acked_Transitions	BACnetEventTransitionBits	-	O	R*
Notify_Type	BACnetNotifyType	-	O	R*
Event_Time_Stamps	BACnetArray[N] of BACnetTimeStamp	-	O	R*
Profile_Name	CharacterString	-	O	-

* Only available when specific object has a Notification Class configured

5.3.8 Remote control lock (all units) (Binary Output Object Type)

It sets the remote control lock for all the indoor units.

Property Identifier	Property Datatype	Value	ASHRAE	IBOX
Object_Identifier	BACnetObjectIdentifier	(Binary Output, 3)	R	R
Object_Name	CharacterString	<i>Remote control lock (all units)</i>	R	R
Object_Type	BACnetObjectType	BINARY_OUTPUT (4)	R	R
Present_Value	BACnetBinaryPV	INACTIVE (0) / ACTIVE (1)	W	W
Description	CharacterString	-	O	-
Device_Type	CharacterString	-	O	-
Status_Flags	BACnetStatusFlags	{FALSE, FALSE, FALSE, FALSE}	R	R
Event_State	BACnetEventState	STATE_NORMAL (0)	R	R
Reliability	BACnetReliability	NO_FAULT_DETECTED (0)	O	R
Out_Of_Service	BOOLEAN	FALSE	R	R
Polarity	BACnetPolarity	NORMAL (0)	R	R
Inactive_Text	CharacterString	<i>"Unlock"</i>	O	R
Active_Text	CharacterString	<i>"Lock"</i>	O	R
Change_Of_State_Time	BACnetDatetime	-	O	R
Change_Of_State_Count	Unsigned	-	O	R
Time_Of_State_Count_Reset	BACnetDatetime	-	O	R
Elapsed_Active_Time	Unsigned	-	O	R
Time_Of_Active_Time_Reset	BACnetDatetime	-	O	R
Minimum_Off_Time	Unsigned32	-	O	-
Minimum_On_Time	Unsigned32	-	O	-
Priority_Array	BACnetPriorityArray	BACnetPriorityArray	R	R
Relinquish_Default	BACnetBinaryPV	INACTIVE (0)	R	R
Time_Delay	Unsigned	-	O	R*
Notification_Class	Unsigned	-	O	R*
Feedback_Value	BACnetBinaryPV	-	O	W
Event_Enable	BACnetEventTransitionBits	-	O	R*
Acked_Transitions	BACnetEventTransitionBits	-	O	R*
Notify_Type	BACnetNotifyType	-	O	R*
Event_Time_Stamps	BACnetArray[N] of BACnetTimeStamp	-	O	R*
Profile_Name	CharacterString	-	O	-

* Only available when specific object has a Notification Class configured

5.3.9 Uxx_On/Off_S (Binary Input Object Type)

It indicates the indoor unit On/Off status.

Property Identifier	Property Datatype	Value	ASHRAE	IBOX
Object_Identifier	BACnetObjectIdentifier	(Binary Input, (xxx*100) + 0)	R	R
Object_Name	CharacterString	<i>Uxx_On/Off_S</i>	R	R
Object_Type	BACnetObjectType	BINARY_INPUT (3)	R	R
Present_Value	BACnetBinaryPV	INACTIVE (0) / ACTIVE (1)	R	R
Description	CharacterString	-	O	-
Device_Type	CharacterString	-	O	-
Status_Flags	BACnetStatusFlags	{FALSE, FALSE/TRUE, FALSE, FALSE}	R	R
Event_State	BACnetEventState	STATE_NORMAL (0)	R	R
Reliability	BACnetReliability	NO_FAULT_DETECTED (0), UNRELIABLE_OTHER (7)	O	R
Out_Of_Service	BOOLEAN	FALSE	R	R
Polarity	BACnetPolarity	NORMAL (0)	R	R
Inactive_Text	CharacterString	"Off"	O	R
Active_Text	CharacterString	"On"	O	R
Change_Of_State_Time	BACnetDatetime	-	O	R
Change_Of_State_Count	Unsigned	-	O	R
Time_Of_State_Count_Reset	BACnetDatetime	-	O	R
Elapsed_Active_Time	Unsigned	-	O	R
Time_Of_Active_Time_Reset	BACnetDatetime	-	O	R
Time_Delay	Unsigned	-	O	R*
Notification_Class	Unsigned	-	O	R*
Alarm_Value	BACnetBinaryPV	-	O	R*
Event_Enable	BACnetEventTransitionBits	-	O	R*
Acked_Transitions	BACnetEventTransitionBits	-	O	R*
Notify_Type	BACnetNotifyType	-	O	R*
Event_Time_Stamps	BACnetArray[N] of BACnetTimeStamp	-	O	R*
Profile_Name	CharacterString	-	O	-

* Only available when specific object has a Notification Class configured

5.3.10 Uxx_On/Off_C (Binary Output Object Type)

It switches the indoor unit On or Off.

Property Identifier	Property Datatype	Value	ASHRAE	IBOX
Object_Identifier	BACnetObjectIdentifier	(Binary Output, (xxx*100) + 0)	R	R
Object_Name	CharacterString	<i>Uxx_On/Off_C</i>	R	R
Object_Type	BACnetObjectType	BINARY_OUTPUT (4)	R	R
Present_Value	BACnetBinaryPV	INACTIVE (0) / ACTIVE (1)	W	W
Description	CharacterString	-	O	-
Device_Type	CharacterString	-	O	-
Status_Flags	BACnetStatusFlags	{FALSE, FALSE, FALSE, FALSE}	R	R
Event_State	BACnetEventState	STATE_NORMAL (0)	R	R
Reliability	BACnetReliability	NO_FAULT_DETECTED (0)	O	R
Out_Of_Service	BOOLEAN	FALSE	R	R
Polarity	BACnetPolarity	NORMAL (0)	R	R
Inactive_Text	CharacterString	<i>"Off"</i>	O	R
Active_Text	CharacterString	<i>"On"</i>	O	R
Change_Of_State_Time	BACnetDatetime	-	O	R
Change_Of_State_Count	Unsigned	-	O	R
Time_Of_State_Count_Reset	BACnetDatetime	-	O	R
Elapsed_Active_Time	Unsigned	-	O	R
Time_Of_Active_Time_Reset	BACnetDatetime	-	O	R
Minimum_Off_Time	Unsigned32	-	O	-
Minimum_On_Time	Unsigned32	-	O	-
Priority_Array	BACnetPriorityArray	BACnetPriorityArray	R	R
Relinquish_Default	BACnetBinaryPV	INACTIVE (0)	R	R
Time_Delay	Unsigned	-	O	R*
Notification_Class	Unsigned	-	O	R*
Feedback_Value	BACnetBinaryPV	-	O	W
Event_Enable	BACnetEventTransitionBits	-	O	R*
Acked_Transitions	BACnetEventTransitionBits	-	O	R*
Notify_Type	BACnetNotifyType	-	O	R*
Event_Time_Stamps	BACnetArray[N] of BACnetTimeStamp	-	O	R*
Profile_Name	CharacterString	-	O	-

* Only available when specific object has a Notification Class configured

5.3.11 Uxx_Mode_S (Multistate Input Object Type)

It indicates the indoor unit mode status.

Property Identifier	Property Datatype	Value	ASHRAE	IBOX
Object_Identifier	BACnetObjectIdentifier	(Multi-state Input, (xxx*100) + 0)	R	R
Object_Name	CharacterString	<i>Uxx_Mode_S</i>	R	R
Object_Type	BACnetObjectType	MULTISTATE_INPUT (13)	R	R
Present_Value	Unsigned	x	R	R
Description	CharacterString	-	O	-
Device_Type	CharacterString	-	O	-
Status_Flags	BACnetStatusFlags	{FALSE, FALSE/TRUE, FALSE, FALSE}	R	R
Event_State	BACnetEventState	STATE_NORMAL (0)	R	R
Reliability	BACnetReliability	NO_FAULT_DETECTED (0), UNRELIABLE_OTHER (7)	O	R
Out_Of_Service	BOOLEAN	FALSE	R	R
Number_Of_States	Unsigned	5	R	R
State_Text	BACnetArray[N] of CharacterString	<i>Check Mode table below</i>	O	R
Time_Delay	Unsigned	-	O	R*
Notification_Class	Unsigned	-	O	R*
Alarm_Values	List of Unsigned	-	O	R*
Fault_Values	List of Unsigned	-	O	R*
Event_Enable	BACnetEventTransitionBits	-	O	R*
Acked_Transitions	BACnetEventTransitionBits	-	O	R*
Notify_Type	BACnetNotifyType	-	O	R*
Event_Time_Stamps	BACnetArray[N] of BACnetTimeStamp	-	O	R*
Profile_Name	CharacterString	-	O	-

* Only available when specific object has a Notification Class configured

Mode table

Mode interpretation is possible using the value in the following correspondence table.

Present_Value	Contents displayed in State_Text
1	Heat
2	Cool
3	Fan
4	Dry
5	Auto

5.3.12 Uxx_Mode_C (Multistate Output Object Type)

It sets the indoor unit mode.

Property Identifier	Property Datatype	Value	ASHRAE	IBOX
Object_Identifier	BACnetObjectIdentifier	(Multi-state Output, (xxx*100) + 0)	R	R
Object_Name	CharacterString	<i>Uxx_Mode_C</i>	R	R
Object_Type	BACnetObjectType	MULTISTATE_OUTPUT (14)	R	R
Present_Value	Unsigned	x	W	W
Description	CharacterString	-	O	-
Device_Type	CharacterString	-	O	-
Status_Flags	BACnetStatusFlags	{FALSE, FALSE, FALSE, FALSE}	R	R
Event_State	BACnetEventState	STATE_NORMAL (0)	R	R
Reliability	BACnetReliability	NO_FAULT_DETECTED (0)	O	R
Out_Of_Service	BOOLEAN	FALSE	R	R
Number_Of_States	Unsigned	5	R	R
State_Text	BACnetArray[N] of CharacterString	<i>Check Mode table below</i>	O	R
Priority_Array	BACnetPriorityArray	BACnetPriorityArray	R	R
Relinquish_Default	Unsigned	1	R	R
Time_Delay	Unsigned	-	O	R*
Notification_Class	Unsigned	-	O	R*
Feedback_Value	Unsigned	-	O	W
Event_Enable	BACnetEventTransitionBits	-	O	R*
Acked_Transitions	BACnetEventTransitionBits	-	O	R*
Notify_Type	BACnetNotifyType	-	O	R*
Event_Time_Stamps	BACnetArray[N] of BACnetTimeStamp	-	O	R*
Profile_Name	CharacterString	-	O	-

* Only available when specific object has a Notification Class configured

Mode table

Mode IU/AHU interpretation is possible using the value in the following correspondence table.

Present_Value	Contents displayed in State_Text
1	Heat
2	Cool
3	Fan
4	Dry
5	Auto

5.3.13 Uxx_Setpoint_S (Analog Input Object Type)

It indicates the indoor unit setpoint status.

Property Identifier	Property Datatype	Value	ASHRAE	IBOX
Object_Identifier	BACnetObjectIdentifier	(Analog Input, (xxx*100) + 0)	R	R
Object_Name	CharacterString	<i>Uxx_Setpoint_S</i>	R	R
Object_Type	BACnetObjectType	ANALOG_INPUT (0)	R	R
Present_Value	REAL	x	R	R
Description	CharacterString	-	O	-
Device_Type	CharacterString	-	O	-
Status_Flags	BACnetStatusFlags	{FALSE, FALSE/TRUE, FALSE, FALSE}	R	R
Event_State	BACnetEventState	STATE_NORMAL (0)	R	R
Reliability	BACnetReliability	NO_FAULT_DETECTED (0), UNRELIABLE_OTHER (7)	O	R
Out_Of_Service	BOOLEAN	FALSE	R	R
Update_Interval	Unsigned	-	O	-
Units	BACnetEngineeringUnits	<i>degrees_Celsius</i>	R	R
Min_Pres_Value	REAL	-	O	-
Max_Pres_Value	REAL	-	O	-
Resolution	REAL	-	O	-
COV_Increment	REAL	0	O	R
Time_Delay	Unsigned	-	O	R*
Notification_Class	Unsigned	-	O	R*
High_Limit	REAL	-	O	R*
Low_Limit	REAL	-	O	R*
Deadband	REAL	-	O	R*
Limit_Enable	BACnetLimitEnable	-	O	R*
Event_Enable	BACnetEventTransitionBits	-	O	R*
Acked_Transitions	BACnetEventTransitionBits	-	O	R*
Notify_Type	BACnetNotifyType	-	O	R*
Event_Time_Stamps	BACnetArray[N] of BACnetTimeStamp	-	O	R*
Profile_Name	CharacterString	-	O	-

* Only available when specific object has a Notification Class configured

5.3.14 Uxx_Setpoint_C (Analog Output Object Type)

It sets the indoor unit setpoint.

Property Identifier	Property Datatype	Value	ASHRAE	IBOX
Object_Identifier	BACnetObjectIdentifier	(Analog Output, (xxx*100) + 0)	R	R
Object_Name	CharacterString	<i>Uxx_Setpoint_C</i>	R	R
Object_Type	BACnetObjectType	ANALOG_OUTPUT (1)	R	R
Present_Value	REAL	x	W	W
Description	CharacterString	-	O	-
Device_Type	CharacterString	-	O	-
Status_Flags	BACnetStatusFlags	{FALSE, FALSE, FALSE, FALSE}	R	R
Event_State	BACnetEventState	STATE_NORMAL (0)	R	R
Reliability	BACnetReliability	NO_FAULT_DETECTED (0)	O	R
Out_Of_Service	BOOLEAN	FALSE	R	R
Update_Interval	Unsigned	-	O	-
Units	BACnetEngineeringUnits	<i>degrees_Celsius</i>	R	R
Min_Pres_Value	REAL	-	O	-
Max_Pres_Value	REAL	-	O	-
Resolution	REAL	-	O	-
COV_Increment	REAL	0	O	R
Priority_Array	BACnetPriorityArray	BACnetPriorityArray	R	R
Relinquish_Default	Unsigned	<i>Configurable through BACnet and Config Tool</i>	R	R
Time_Delay	Unsigned	-	O	R*
Notification_Class	Unsigned	-	O	R*
High_Limit	REAL	-	O	R*
Low_Limit	REAL	-	O	R*
Deadband	REAL	-	O	R*
Limit_Enable	BACnetLimitEnable	-	O	R*
Event_Enable	BACnetEventTransitionBits	-	O	R*
Acked_Transitions	BACnetEventTransitionBits	-	O	R*
Notify_Type	BACnetNotifyType	-	O	R*
Event_Time_Stamps	BACnetArray[N] of BACnetTimeStamp	-	O	R*
Profile_Name	CharacterString	-	O	-

* Only available when specific object has a Notification Class configured

5.3.15 Uxx_FanSpeed_S (Multistate Input Object Type)

It indicates the indoor unit fan speed status.

Property Identifier	Property Datatype	Value	ASHRAE	IBOX
Object_Identifier	BACnetObjectIdentifier	(Multi-state Input, (xxx*100) + 1)	R	R
Object_Name	CharacterString	<i>Uxx_FanSpeed_S</i>	R	R
Object_Type	BACnetObjectType	MULTISTATE_INPUT (13)	R	R
Present_Value	Unsigned	x	R	R
Description	CharacterString	-	O	-
Device_Type	CharacterString	-	O	-
Status_Flags	BACnetStatusFlags	{FALSE, FALSE/TRUE, FALSE, FALSE}	R	R
Event_State	BACnetEventState	STATE_NORMAL (0)	R	R
Reliability	BACnetReliability	NO_FAULT_DETECTED (0), UNRELIABLE_OTHER (7)	O	R
Out_Of_Service	BOOLEAN	FALSE	R	R
Number_Of_States	Unsigned	4	R	R
State_Text	BACnetArray[N] of CharacterString	<i>Check FanSpeed table below</i>	O	R
Time_Delay	Unsigned	-	O	R*
Notification_Class	Unsigned	-	O	R*
Alarm_Values	List of Unsigned	-	O	R*
Fault_Values	List of Unsigned	-	O	R*
Event_Enable	BACnetEventTransitionBits	-	O	R*
Acked_Transitions	BACnetEventTransitionBits	-	O	R*
Notify_Type	BACnetNotifyType	-	O	R*
Event_Time_Stamps	BACnetArray[N] of BACnetTimeStamp	-	O	R*
Profile_Name	CharacterString	-	O	-

* Only available when specific object has a Notification Class configured

FanSpeed table

FanSpeed interpretation is possible using the value in the following correspondence table.

Present_Value	Contents displayed in State_Text
1	Auto
2	Low
3	Med
4	High

5.3.16 Uxx_FanSpeed_C (Multistate Output Object Type)

It sets the indoor unit fan speed.

Property Identifier	Property Datatype	Value	ASHRAE	IBOX
Object_Identifier	BACnetObjectIdentifier	(Multi-state Output, (xxx*100) + 1)	R	R
Object_Name	CharacterString	<i>Uxx_FanSpeed_C</i>	R	R
Object_Type	BACnetObjectType	MULTISTATE_OUTPUT (14)	R	R
Present_Value	Unsigned	x	W	W
Description	CharacterString	-	O	-
Device_Type	CharacterString	-	O	-
Status_Flags	BACnetStatusFlags	{FALSE, FALSE, FALSE, FALSE}	R	R
Event_State	BACnetEventState	STATE_NORMAL (0)	R	R
Reliability	BACnetReliability	NO_FAULT_DETECTED (0)	O	R
Out_Of_Service	BOOLEAN	FALSE	R	R
Number_Of_States	Unsigned	4	R	R
State_Text	BACnetArray[N] of CharacterString	<i>Check FanSpeed table below</i>	O	R
Priority_Array	BACnetPriorityArray	BACnetPriorityArray	R	R
Relinquish_Default	Unsigned	1	R	R
Time_Delay	Unsigned	-	O	R*
Notification_Class	Unsigned	-	O	R*
Feedback_Value	Unsigned	-	O	W
Event_Enable	BACnetEventTransitionBits	-	O	R*
Acked_Transitions	BACnetEventTransitionBits	-	O	R*
Notify_Type	BACnetNotifyType	-	O	R*
Event_Time_Stamps	BACnetArray[N] of BACnetTimeStamp	-	O	R*
Profile_Name	CharacterString	-	O	-

* Only available when specific object has a Notification Class configured

FanSpeed table

FanSpeed interpretation is possible using the value in the following correspondence table.

Present_Value	Contents displayed in State_Text
1	Auto
2	Low
3	Med
4	High

5.3.17 Uxx_Vane position_S (Binary Input Object Type)

It indicates the indoor unit vane position status.

Property Identifier	Property Datatype	Value	ASHRAE	IBOX
Object_Identifier	BACnetObjectIdentifier	(Binary Input, (xxx*100) + 1)	R	R
Object_Name	CharacterString	<i>Uxx_Vane position_S</i>	R	R
Object_Type	BACnetObjectType	BINARY_INPUT (3)	R	R
Present_Value	BACnetBinaryPV	INACTIVE (0) / ACTIVE (1)	R	R
Description	CharacterString	-	O	-
Device_Type	CharacterString	-	O	-
Status_Flags	BACnetStatusFlags	{FALSE, FALSE/TRUE, FALSE, FALSE}	R	R
Event_State	BACnetEventState	STATE_NORMAL (0)	R	R
Reliability	BACnetReliability	NO_FAULT_DETECTED (0), UNRELIABLE_OTHER (7)	O	R
Out_Of_Service	BOOLEAN	FALSE	R	R
Polarity	BACnetPolarity	NORMAL (0)	R	R
Inactive_Text	CharacterString	"Swing Off"	O	R
Active_Text	CharacterString	"Swing On"	O	R
Change_Of_State_Time	BACnetDatetime	-	O	R
Change_Of_State_Count	Unsigned	-	O	R
Time_Of_State_Count_Reset	BACnetDatetime	-	O	R
Elapsed_Active_Time	Unsigned	-	O	R
Time_Of_Active_Time_Reset	BACnetDatetime	-	O	R
Time_Delay	Unsigned	-	O	R*
Notification_Class	Unsigned	-	O	R*
Alarm_Value	BACnetBinaryPV	-	O	R*
Event_Enable	BACnetEventTransitionBits	-	O	R*
Acked_Transitions	BACnetEventTransitionBits	-	O	R*
Notify_Type	BACnetNotifyType	-	O	R*
Event_Time_Stamps	BACnetArray[N] of BACnetTimeStamp	-	O	R*
Profile_Name	CharacterString	-	O	-

* Only available when specific object has a Notification Class configured

5.3.18 Uxx_Vane position_C (Binary Output Object Type)

It sets the indoor unit vane position.

Property Identifier	Property Datatype	Value	ASHRAE	IBOX
Object_Identifier	BACnetObjectIdentifier	(Binary Output, (xxx*100) + 1)	R	R
Object_Name	CharacterString	<i>Uxx_Vane position_C</i>	R	R
Object_Type	BACnetObjectType	BINARY_OUTPUT (4)	R	R
Present_Value	BACnetBinaryPV	INACTIVE (0) / ACTIVE (1)	W	W
Description	CharacterString	-	O	-
Device_Type	CharacterString	-	O	-
Status_Flags	BACnetStatusFlags	{FALSE, FALSE, FALSE, FALSE}	R	R
Event_State	BACnetEventState	STATE_NORMAL (0)	R	R
Reliability	BACnetReliability	NO_FAULT_DETECTED (0)	O	R
Out_Of_Service	BOOLEAN	FALSE	R	R
Polarity	BACnetPolarity	NORMAL (0)	R	R
Inactive_Text	CharacterString	<i>"Swing Off"</i>	O	R
Active_Text	CharacterString	<i>"Swing On"</i>	O	R
Change_Of_State_Time	BACnetDatetime	-	O	R
Change_Of_State_Count	Unsigned	-	O	R
Time_Of_State_Count_Reset	BACnetDatetime	-	O	R
Elapsed_Active_Time	Unsigned	-	O	R
Time_Of_Active_Time_Reset	BACnetDatetime	-	O	R
Minimum_Off_Time	Unsigned32	-	O	-
Minimum_On_Time	Unsigned32	-	O	-
Priority_Array	BACnetPriorityArray	BACnetPriorityArray	R	R
Relinquish_Default	BACnetBinaryPV	INACTIVE (0)	R	R
Time_Delay	Unsigned	-	O	R*
Notification_Class	Unsigned	-	O	R*
Feedback_Value	BACnetBinaryPV	-	O	W
Event_Enable	BACnetEventTransitionBits	-	O	R*
Acked_Transitions	BACnetEventTransitionBits	-	O	R*
Notify_Type	BACnetNotifyType	-	O	R*
Event_Time_Stamps	BACnetArray[N] of BACnetTimeStamp	-	O	R*
Profile_Name	CharacterString	-	O	-

* Only available when specific object has a Notification Class configured.

5.3.19 Uxx_Room Temperature (Analog Input Object Type)

It indicates the room temperature.

Property Identifier	Property Datatype	Value	ASHRAE	IBOX
Object_Identifier	BACnetObjectIdentifier	(Analog Input, (xxx*100) + 1)	R	R
Object_Name	CharacterString	<i>Uxx_Room Temperature</i>	R	R
Object_Type	BACnetObjectType	ANALOG_INPUT (0)	R	R
Present_Value	REAL	x	R	R
Description	CharacterString	-	O	-
Device_Type	CharacterString	-	O	-
Status_Flags	BACnetStatusFlags	{FALSE, FALSE/TRUE, FALSE, FALSE}	R	R
Event_State	BACnetEventState	STATE_NORMAL (0)	R	R
Reliability	BACnetReliability	NO_FAULT_DETECTED (0), UNRELIABLE_OTHER (7)	O	R
Out_Of_Service	BOOLEAN	FALSE	R	R
Update_Interval	Unsigned	-	O	-
Units	BACnetEngineeringUnits	<i>degrees_Celsius</i>	R	R
Min_Pres_Value	REAL	-35°C	O	-
Max_Pres_Value	REAL	92,5°C	O	-
Resolution	REAL	-	O	-
COV_Increment	REAL	0	O	R
Time_Delay	Unsigned	-	O	R*
Notification_Class	Unsigned	-	O	R*
High_Limit	REAL	-	O	R*
Low_Limit	REAL	-	O	R*
Deadband	REAL	-	O	R*
Limit_Enable	BACnetLimitEnable	-	O	R*
Event_Enable	BACnetEventTransitionBits	-	O	R*
Acked_Transitions	BACnetEventTransitionBits	-	O	R*
Notify_Type	BACnetNotifyType	-	O	R*
Event_Time_Stamps	BACnetArray[N] of BACnetTimeStamp	-	O	R*
Profile_Name	CharacterString	-	O	-

* Only available when specific object has a Notification Class configured

5.3.20 Uxx_Unit Error code (Analog Input Object Type)

It indicates the current error present in the AC system. Check **10 ERROR CODES** for more information.

Property Identifier	Property Datatype	Value	ASHRAE	IBOX
Object_Identifier	BACnetObjectIdentifier	(Analog Input, (xxx*100) + 2)	R	R
Object_Name	CharacterString	<i>Uxx_Unit Error code</i>	R	R
Object_Type	BACnetObjectType	ANALOG_INPUT (0)	R	R
Present_Value	REAL	x	R	R
Description	CharacterString	-	O	-
Device_Type	CharacterString	-	O	-
Status_Flags	BACnetStatusFlags	{FALSE, FALSE/TRUE, FALSE, FALSE}	R	R
Event_State	BACnetEventState	STATE_NORMAL (0)	R	R
Reliability	BACnetReliability	NO_FAULT_DETECTED (0), UNRELIABLE_OTHER (7)	O	R
Out_Of_Service	BOOLEAN	FALSE	R	R
Number_Of_States	Unsigned	37	R	R
State_Text	BACnetArray[N] of CharacterString	<i>Check Error Code table below.</i>	O	R
Time_Delay	Unsigned	-	O	-
Notification_Class	Unsigned	-	O	-
Alarm_Values	List of Unsigned	-	O	-
Fault_Values	List of Unsigned	-	O	-
Event_Enable	BACnetEventTransitionBits	-	O	-
Acked_Transitions	BACnetEventTransitionBits	-	O	-
Notify_Type	BACnetNotifyType	-	O	-
Event_Time_Stamps	BACnetArray[N] of BACnetTimeStamp	-	O	-
Profile_Name	CharacterString	-	O	-

Error Code table

In the table below you will find the error correspondence value

Present_Value	State_Text
0	N/A
1	E0
2	E1
3	E2
4	E3
5	E4
6	E5
7	E6
8	E7
9	E8
10	E9
11	EA
12	EB
13	EC
14	ED
15	EE
16	EF
101	P0
102	P1
103	P2
104	P3
105	P4
106	P5
107	P6
108	P7
109	P8
110	P9
111	PA
112	PB
113	PC
114	PD
115	PE
116	PF
65535 (-1)	N/A
-100	N/A
-200	N/A

5.3.21 Uxx_Communication Error IU (Binary Input Object Type)

It indicates if there is an error active in the indoor unit.

Property Identifier	Property Datatype	Value	ASHRAE	IBOX
Object_Identifier	BACnetObjectIdentifier	(Binary Input, (xxx*100) + 2)	R	R
Object_Name	CharacterString	<i>Uxx_Communication Error IU</i>	R	R
Object_Type	BACnetObjectType	BINARY_INPUT (3)	R	R
Present_Value	BACnetBinaryPV	INACTIVE (0) / ACTIVE (1)	R	R
Description	CharacterString	-	O	-
Device_Type	CharacterString	-	O	-
Status_Flags	BACnetStatusFlags	{FALSE, FALSE/TRUE, FALSE, FALSE}	R	R
Event_State	BACnetEventState	STATE_NORMAL (0)	R	R
Reliability	BACnetReliability	NO_FAULT_DETECTED (0), UNRELIABLE_OTHER (7)	O	R
Out_Of_Service	BOOLEAN	FALSE	R	R
Polarity	BACnetPolarity	NORMAL (0)	R	R
Inactive_Text	CharacterString	<i>"No error"</i>	O	R
Active_Text	CharacterString	<i>"Error"</i>	O	R
Change_Of_State_Time	BACnetDatetime	-	O	R
Change_Of_State_Count	Unsigned	-	O	R
Time_Of_State_Count_Reset	BACnetDatetime	-	O	R
Elapsed_Active_Time	Unsigned	-	O	R
Time_Of_Active_Time_Reset	BACnetDatetime	-	O	R
Time_Delay	Unsigned	-	O	R*
Notification_Class	Unsigned	-	O	R*
Alarm_Value	BACnetBinaryPV	-	O	R*
Event_Enable	BACnetEventTransitionBits	-	O	R*
Acked_Transitions	BACnetEventTransitionBits	-	O	R*
Notify_Type	BACnetNotifyType	-	O	R*
Event_Time_Stamps	BACnetArray[N] of BACnetTimeStamp	-	O	R*
Profile_Name	CharacterString	-	O	-

* Only available when specific object has a Notification Class configured

5.3.22 Uxx_Remote control lock_S (Binary Input Object Type)

It indicates if the remote control of the indoor unit is locked or not.

Property Identifier	Property Datatype	Value	ASHRAE	IBOX
Object_Identifier	BACnetObjectIdentifier	(Binary Input, (xxx*100) + 3)	R	R
Object_Name	CharacterString	<i>Uxx_Remote control lock_S</i>	R	R
Object_Type	BACnetObjectType	BINARY_INPUT (3)	R	R
Present_Value	BACnetBinaryPV	INACTIVE (0) / ACTIVE (1)	R	R
Description	CharacterString	-	O	-
Device_Type	CharacterString	-	O	-
Status_Flags	BACnetStatusFlags	{FALSE, FALSE/TRUE, FALSE, FALSE}	R	R
Event_State	BACnetEventState	STATE_NORMAL (0)	R	R
Reliability	BACnetReliability	NO_FAULT_DETECTED (0), UNRELIABLE_OTHER (7)	O	R
Out_Of_Service	BOOLEAN	FALSE	R	R
Polarity	BACnetPolarity	NORMAL (0)	R	R
Inactive_Text	CharacterString	<i>"Unlock"</i>	O	R
Active_Text	CharacterString	<i>"Lock"</i>	O	R
Change_Of_State_Time	BACnetDatetime	-	O	R
Change_Of_State_Count	Unsigned	-	O	R
Time_Of_State_Count_Reset	BACnetDatetime	-	O	R
Elapsed_Active_Time	Unsigned	-	O	R
Time_Of_Active_Time_Reset	BACnetDatetime	-	O	R
Time_Delay	Unsigned	-	O	R*
Notification_Class	Unsigned	-	O	R*
Alarm_Value	BACnetBinaryPV	-	O	R*
Event_Enable	BACnetEventTransitionBits	-	O	R*
Acked_Transitions	BACnetEventTransitionBits	-	O	R*
Notify_Type	BACnetNotifyType	-	O	R*
Event_Time_Stamps	BACnetArray[N] of BACnetTimeStamp	-	O	R*
Profile_Name	CharacterString	-	O	-

* Only available when specific object has a Notification Class configured

5.3.23 Uxx_Remote control lock_C (Binary Output Object Type)

It locks/unlocks the remote controller of the indoor unit.

Property Identifier	Property Datatype	Value	ASHRAE	IBOX
Object_Identifier	BACnetObjectIdentifier	(Binary Output, (xxx*100) + 2)	R	R
Object_Name	CharacterString	<i>Uxx_Remote control lock_C</i>	R	R
Object_Type	BACnetObjectType	BINARY_OUTPUT (4)	R	R
Present_Value	BACnetBinaryPV	INACTIVE (0) / ACTIVE (1)	W	W
Description	CharacterString	-	O	-
Device_Type	CharacterString	-	O	-
Status_Flags	BACnetStatusFlags	{FALSE, FALSE, FALSE, FALSE}	R	R
Event_State	BACnetEventState	STATE_NORMAL (0)	R	R
Reliability	BACnetReliability	NO_FAULT_DETECTED (0)	O	R
Out_Of_Service	BOOLEAN	FALSE	R	R
Polarity	BACnetPolarity	NORMAL (0)	R	R
Inactive_Text	CharacterString	<i>"Unlock"</i>	O	R
Active_Text	CharacterString	<i>"Lock"</i>	O	R
Change_Of_State_Time	BACnetDatetime	-	O	R
Change_Of_State_Count	Unsigned	-	O	R
Time_Of_State_Count_Reset	BACnetDatetime	-	O	R
Elapsed_Active_Time	Unsigned	-	O	R
Time_Of_Active_Time_Reset	BACnetDatetime	-	O	R
Minimum_Off_Time	Unsigned32	-	O	-
Minimum_On_Time	Unsigned32	-	O	-
Priority_Array	BACnetPriorityArray	BACnetPriorityArray	R	R
Relinquish_Default	BACnetBinaryPV	INACTIVE (0)	R	R
Time_Delay	Unsigned	-	O	R*
Notification_Class	Unsigned	-	O	R*
Feedback_Value	BACnetBinaryPV	-	O	W
Event_Enable	BACnetEventTransitionBits	-	O	R*
Acked_Transitions	BACnetEventTransitionBits	-	O	R*
Notify_Type	BACnetNotifyType	-	O	R*
Event_Time_Stamps	BACnetArray[N] of BACnetTimeStamp	-	O	R*
Profile_Name	CharacterString	-	O	-

* Only available when specific object has a Notification Class configured

5.3.24 Uxx_Operation mode force_S (Binary Input Object Type)

It indicates if the operating mode force is activated or not for the indoor unit.

Property Identifier	Property Datatype	Value	ASHRAE	IBOX
Object_Identifier	BACnetObjectIdentifier	(Binary Input, (xxx*100) + 4)	R	R
Object_Name	CharacterString	<i>Uxx_Operating mode force_S</i>	R	R
Object_Type	BACnetObjectType	BINARY_INPUT (3)	R	R
Present_Value	BACnetBinaryPV	INACTIVE (0) / ACTIVE (1)	R	R
Description	CharacterString	-	O	-
Device_Type	CharacterString	-	O	-
Status_Flags	BACnetStatusFlags	{FALSE, FALSE/TRUE, FALSE, FALSE}	R	R
Event_State	BACnetEventState	STATE_NORMAL (0)	R	R
Reliability	BACnetReliability	NO_FAULT_DETECTED (0), UNRELIABLE_OTHER (7)	O	R
Out_Of_Service	BOOLEAN	FALSE	R	R
Polarity	BACnetPolarity	NORMAL (0)	R	R
Inactive_Text	CharacterString	"No force"	O	R
Active_Text	CharacterString	"Force"	O	R
Change_Of_State_Time	BACnetDatetime	-	O	R
Change_Of_State_Count	Unsigned	-	O	R
Time_Of_State_Count_Reset	BACnetDatetime	-	O	R
Elapsed_Active_Time	Unsigned	-	O	R
Time_Of_Active_Time_Reset	BACnetDatetime	-	O	R
Time_Delay	Unsigned	-	O	R*
Notification_Class	Unsigned	-	O	R*
Alarm_Value	BACnetBinaryPV	-	O	R*
Event_Enable	BACnetEventTransitionBits	-	O	R*
Acked_Transitions	BACnetEventTransitionBits	-	O	R*
Notify_Type	BACnetNotifyType	-	O	R*
Event_Time_Stamps	BACnetArray[N] of BACnetTimeStamp	-	O	R*
Profile_Name	CharacterString	-	O	-

* Only available when specific object has a Notification Class configured

5.3.25 Uxx_Operating mode force_C (Binary Input Object Type)

It sets the operating mode force for the indoor unit.

Property Identifier	Property Datatype	Value	ASHRAE	IBOX
Object_Identifier	BACnetObjectIdentifier	(Binary Input, (xxx*100) + 3)	R	R
Object_Name	CharacterString	<i>Uxx_Operating mode force_C</i>	R	R
Object_Type	BACnetObjectType	BINARY_INPUT (3)	R	R
Present_Value	BACnetBinaryPV	INACTIVE (0) / ACTIVE (1)	R	R
Description	CharacterString	-	O	-
Device_Type	CharacterString	-	O	-
Status_Flags	BACnetStatusFlags	{FALSE, FALSE/TRUE, FALSE, FALSE}	R	R
Event_State	BACnetEventState	STATE_NORMAL (0)	R	R
Reliability	BACnetReliability	NO_FAULT_DETECTED (0), UNRELIABLE_OTHER (7)	O	R
Out_Of_Service	BOOLEAN	FALSE	R	R
Polarity	BACnetPolarity	NORMAL (0)	R	R
Inactive_Text	CharacterString	"No force"	O	R
Active_Text	CharacterString	"Force"	O	R
Change_Of_State_Time	BACnetDatetime	-	O	R
Change_Of_State_Count	Unsigned	-	O	R
Time_Of_State_Count_Reset	BACnetDatetime	-	O	R
Elapsed_Active_Time	Unsigned	-	O	R
Time_Of_Active_Time_Reset	BACnetDatetime	-	O	R
Time_Delay	Unsigned	-	O	R*
Notification_Class	Unsigned	-	O	R*
Alarm_Value	BACnetBinaryPV	-	O	R*
Event_Enable	BACnetEventTransitionBits	-	O	R*
Acked_Transitions	BACnetEventTransitionBits	-	O	R*
Notify_Type	BACnetNotifyType	-	O	R*
Event_Time_Stamps	BACnetArray[N] of BACnetTimeStamp	-	O	R*
Profile_Name	CharacterString	-	O	-

* Only available when specific object has a Notification Class configured

6 Connections

Find below information regarding the Intesis connections available.

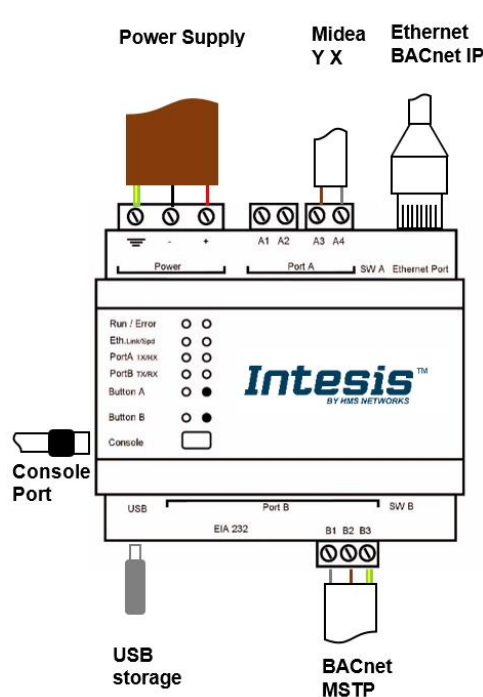

Power Supply

Must use NEC Class 2 or Limited Power Source (LPS) and SELV rated power supply.

If using DC power supply:

Respect polarity applied of terminals (+) and (-). Be sure the voltage applied is within the range admitted (check table below). The power supply can be connected to earth but only through the negative terminal, never through the positive terminal.

If using AC power supply:

Make sure the voltage applied is of the value admitted (24 Vac). Do not connect any of the terminals of the AC power supply to earth, and make sure the same power supply is not supplying any other device.

Ethernet / BACnet IP

Connect the cable coming from the IP network to the connector ETH of the gateway. Use an Ethernet CAT5 cable. If communicating through the LAN of the building, contact the network administrator and make sure traffic on the port used is allowed through all the LAN path (check the gateway user manual for more information). Default IP is 192.168.100.246. DHCP is enabled by default.

PortA / Midea VRF

Connect the XY terminals of Midea XYE Outdoor Unit to the connectors A3 (Y) A4 (X) of gateway's PortA. Respect the polarity.

PortB / BACnet MSTP

Connect the EIA485 bus to connectors B1 (-), B2 (+) and B3 (SNGD) of gateway's PortB. Respect the polarity.

Note for PortB; Remember the characteristics of the standard EIA485 bus: maximum distance of 1200 meters, maximum 32 devices connected to the bus, and in each end of the bus it must be a termination resistor of 120 Ω. The port includes a DIP-Switch for configuration of biasing circuit as well as termination:

SW1:

- ON:** 120 Ω termination active
- OFF:** 120 Ω termination inactive

SW2-3:

- ON:** Polarization active
- OFF:** Polarization inactive

If the gateway is installed in one bus end, make sure that termination is active.

Console Port

Connect a mini-type B USB cable from your computer to the gateway to allow communication between the Configuration Software and the gateway. Remember that Ethernet connection is also allowed. Check the user manual for more information.

USB

Connect a USB storage device (not an HDD) if required. Check the user manual for more information.

Ensure proper space for all connectors when mounted (see section 9).

6.1 Power device

The first step to perform is to power up the device. To do so, a power supply working with any of the voltage range allowed is needed (check section 8). Once connected the ON led will turn on.

WARNING! To avoid earth loops that can damage the gateway, and/or any other equipment connected to it, we strongly recommend:

- The use of DC power supplies, floating or with the negative terminal connected to earth. **Never use a DC power supply with the positive terminal connected to earth.**
- The use of AC power supplies only if they are floating and not powering any other device.

6.2 Connection to BACnet

6.2.1 BACnet IP

Connect the communication cable coming from the network hub or switch to the ETH port (Figure above) of Intesis. The cable to be used shall be a straight Ethernet UTP/FTP CAT5 cable

In case there is no response from Intesis to the frames sent by the BACnet client device, check that both the client and Intesis are operative and reachable from the network connection used by Intesis. Check the Intesis Ethernet interface sending *Pings* to its IP address using a PC connected to the same Ethernet network.

Check as well with the network admin that there are no limitations regarding UDP communication or ports blocked.

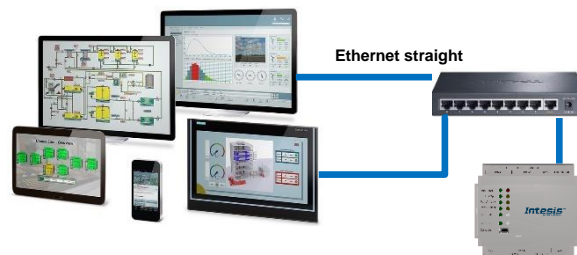

BACnet IP connection using switch/hub and straight cable

6.2.2 BACnet MSTP

Connect the EIA485 bus to connectors B1 (-), B2 (+) and B3 (SNGD) of gateway's PortB. Respect the polarity.

Remember the characteristics of the standard EIA485 bus: maximum distance of 1200 meters, maximum 32 devices connected to the bus, and in each end of the bus it must be a termination resistor of 120 Ω . Set port switch SW1 to ON if gateway is installed on one bus end. SW2-3 will generally go to OFF (polarization inactive), unless there isn't a client / header device providing polarization in the bus.

6.3 Connect to Midea installation

Use the PortA connector in the top corner of the Intesis device in order to connect Midea XY bus to the Intesis. Remember to follow all safety precautions indicated by Midea.

Connect the XY terminals of Midea XYE Outdoor Unit to the connectors A3 (Y) A4 (X) of gateway's PortA. Respect the polarity.

6.4 Connect to the configuration tool

This action allows the user to have access to configuration and monitoring of the device (more information can be found in the configuration tool User Manual). Two methods to connect to the PC can be used:

- **Ethernet:** Using the Ethernet port of Intesis.
- **USB:** Using the console port of Intesis, connect a USB cable from the console port to the PC.

7 Set-up process and troubleshooting

7.1 Pre-requisites

It is necessary to have a BACnet IP client or MSTP device operative and well connected to the corresponding BACnet port of Intesis and the Midea Comercial & VRF installation connected to their corresponding ports as well.

Connectors, connection cables, PC to use the configuration tool and other auxiliary material, if needed, are not supplied by HMS Industrial Networks for this standard integration.

Items supplied by HMS Industrial Networks for this integration are:

- Intesis gateway.
- Link to download the configuration tool.
- Product documentation.
- USB cable to connect from PC to the gateway.

7.2 Intesis MAPS. Configuration & monitoring tool for Intesis BACnet series

7.2.1 Introduction

Intesis MAPS is a Windows® compatible software developed specifically to monitor and configure Intesis new generation gateways.

The installation procedure and main functions are explained in the *Intesis MAPS BACnet User Manual*. This document can be downloaded from the link indicated in the installation sheet supplied with the Intesis device or in the product website at www.intesis.com.

In this section, only the specific case of Midea Comercial & VRF to BACnet systems will be covered.

Please check the Intesis MAPS BACnet User Manual for specific information about the different parameters and how to configure them.

7.2.2 Connection

To configure the Intesis connection parameters press on the **Connection** button in the *menu bar*.

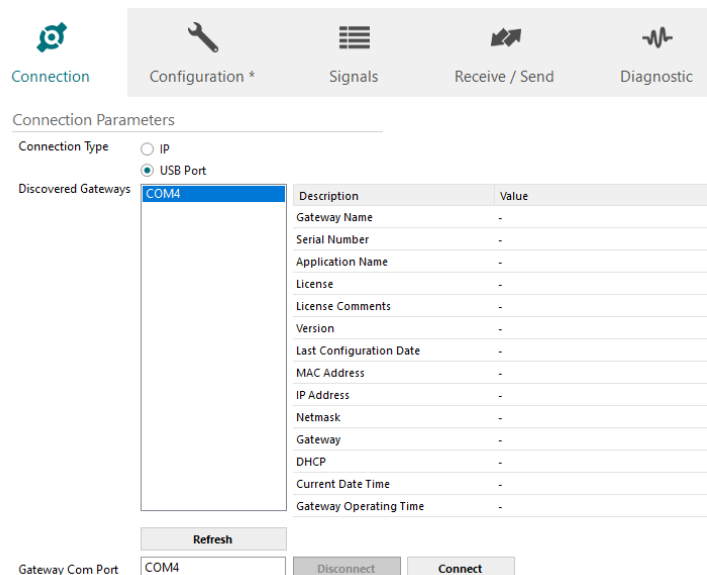

Figure 7.1 MAPS connection

7.2.3 Configuration tab

Select the **Configuration** tab to configure the connection parameters. Three subsets of information are shown in this window: General (Gateway general parameters), BACnet Server (BACnet interface configuration) and Midea (Midea Comercial & VRF interface parameters).

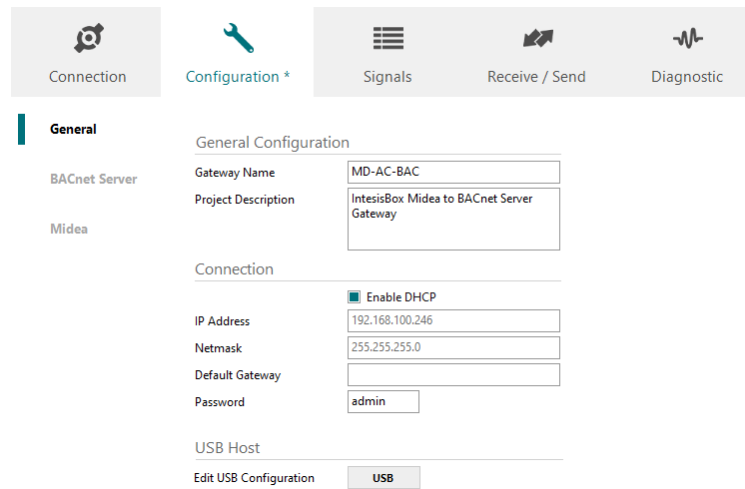

Figure 7.2 Intesis MAPS configuration tab

7.2.4 BACnet Server configuration

Set parameters of BACnet interface of Intesis. Find description of these settings in *Intesis MAPS BACnet User Manual*.

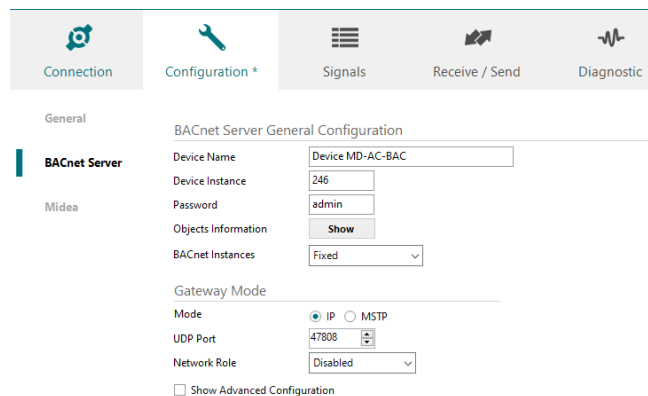

Figure 7.3 Intesis MAPS BACnet configuration tab

7.2.5 Midea configuration

Set parameters for connection with Midea's installation.

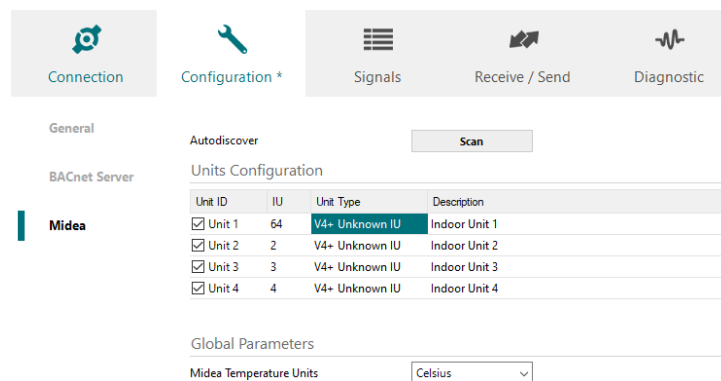

Figure 7.4 Intesis MAPS Midea configuration tab

In Units Configuration section you need to enter, for each unit:

- **Unit ID.** If it's active (checkbox at Unit xx), ranging from 1 to 4 indoor units that will be integrated (maximum number of units will depend on Intesis model)
- **Unit type.** Type will default to "V4+ Unknown IU". When units have been detected after scan, it can be one of the following: TBD, GHP, PAC, VRF.
- **IU address.** Address 1...64 of Unit in Midea system.
- **Description.** Descriptive name to ease identification of the unit (for example, 'living room floor 1 unit', etc).

Additional to manual entry of each unit, autodiscover of present units in an XYE installation is possible. To do so, click button **Scan**. Following window will appear:

Add	IU	Model
-----	----	-------

Figure 7.5 Intesis MAPS Scan Midea Units window

By pressing **Scan** button, connected Midea XY bus will be scanned for available units. Error window will appear if there is a problem in the connection with XYE bus (units not powered, bus not connected, ...).

A progress bar will appear during the scan, which will take up to a few minutes. After scan is completed, detected units will be shown in available units as follows:

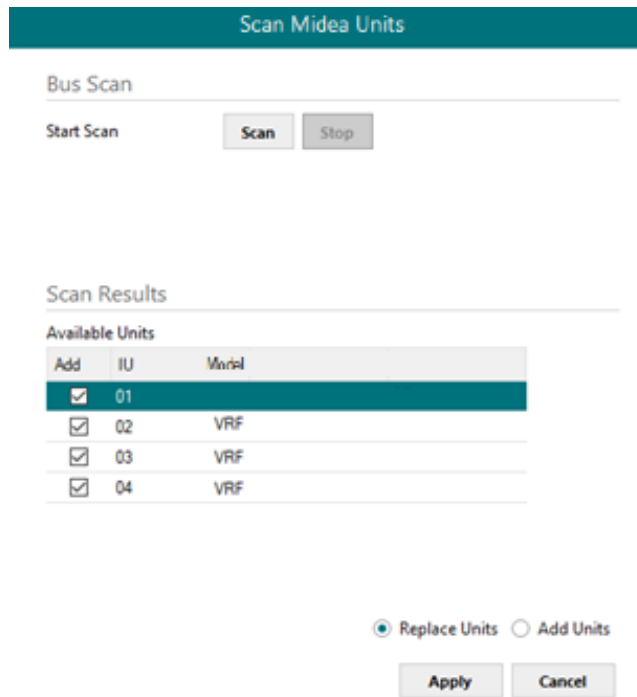

Figure 7.6 Intesis MAPS Scan Midea Units window with scan results

Select with its checkbox units to add (or replace) in installation, according to selection **Replace Units / Add Units**. After units to be integrated are selected, click button **Apply**, and changes will appear in previous **Units Configuration** window.

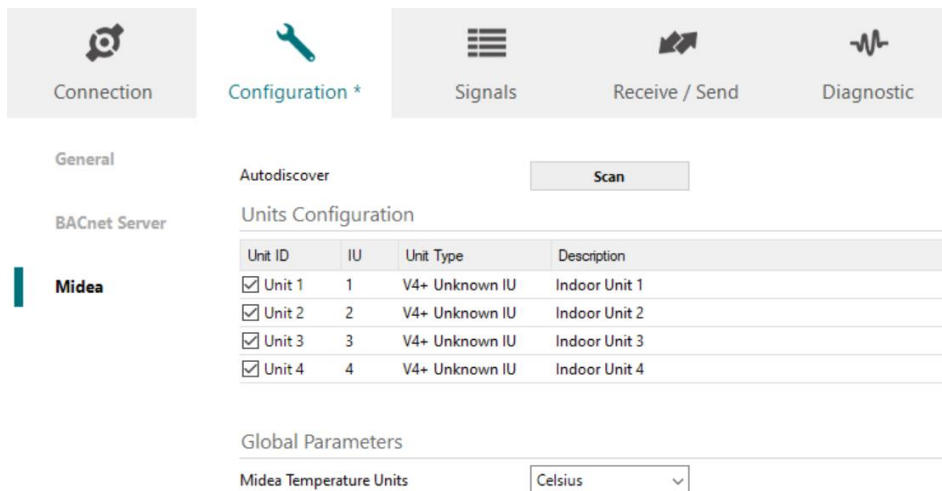

Figure 7.7 Intesis MAPS Midea configuration tab after importing scan results

7.2.6 Signals

All available objects, Object Instances, its corresponding AC signal and other main parameters are listed in the signals tab. More information on each parameter and how to configure it can be found in the Intesis MAPS BACnet user manual.

MD-AC-BACibmaps - IntesisBox MAPS - 1.0.33.2									
Home Project Tools View Help									
Connection Configuration * Signals Receive / Send Diagnostic									
#	Active	Description	BACnet Server				Midea		
			Name	Type	Instance	Units	Unit	IU	Line
1	<input checked="" type="checkbox"/>	0-Off, 1-On	On/Off (all units)	4: BO	0	-	-	-	-
2	<input checked="" type="checkbox"/>	1-Heat, 2-Cool, 3-Fan, 4-Dry, 5-Auto	Mode (all units)	14: MO	0	-	-	-	-
3	<input checked="" type="checkbox"/>	1-Auto, 2-Low, 3-Med, 4-High	FanSpeed (all units)	14: MO	1	-	-	-	-
4	<input checked="" type="checkbox"/>	0-Swing Off, 1-Swing On	Vane Position (all units)	4: BO	1	-	-	-	-
5	<input checked="" type="checkbox"/>	16..30 °C	Temperature Setpoint (all units)	1: AO	0	degrees_Celsius (62)	-	-	-
6	<input checked="" type="checkbox"/>	0-No force, 1-Force	Operating mode force (all Units)	4: BO	2	-	-	-	-
7	<input checked="" type="checkbox"/>	0-Unlock, 1-Lock	Remote control lock (all units)	4: BO	3	-	-	-	-
8	<input checked="" type="checkbox"/>	0-Off, 1-On	U01_On/Off_S	3: BI	100	-	Unit 1 - Indoor Unit 1	1	Line 1
9	<input checked="" type="checkbox"/>	0-Off, 1-On	U01_On/Off_C	4: BO	100	-	Unit 1 - Indoor Unit 1	1	Line 1
10	<input checked="" type="checkbox"/>	1-Heat, 2-Cool, 3-Fan, 4-Dry, 5-Auto	U01_Mode_S	13: MI	100	-	Unit 1 - Indoor Unit 1	1	Line 1
11	<input checked="" type="checkbox"/>	1-Heat, 2-Cool, 3-Fan, 4-Dry, 5-Auto	U01_Mode_C	14: MO	100	-	Unit 1 - Indoor Unit 1	1	Line 1
12	<input checked="" type="checkbox"/>	17..30 °C	U01_Setpoint_S	0: AI	100	degrees_Celsius (62)	Unit 1 - Indoor Unit 1	1	Line 1
13	<input checked="" type="checkbox"/>	17..30 °C	U01_Setpoint_C	1: AO	100	degrees_Celsius (62)	Unit 1 - Indoor Unit 1	1	Line 1
14	<input checked="" type="checkbox"/>	1-Auto, 2-Low, 3-Med, 4-High	U01_FanSpeed_S	13: MI	101	-	Unit 1 - Indoor Unit 1	1	Line 1
15	<input checked="" type="checkbox"/>	1-Auto, 2-Low, 3-Med, 4-High	U01_FanSpeed_C	14: MO	101	-	Unit 1 - Indoor Unit 1	1	Line 1
16	<input checked="" type="checkbox"/>	0-Swing Off, 1-Swing On	U01_Vane Position_S	3: BI	101	-	Unit 1 - Indoor Unit 1	1	Line 1
17	<input checked="" type="checkbox"/>	0-Swing Off, 1-Swing On	U01_Vane Position_C	4: BO	101	-	Unit 1 - Indoor Unit 1	1	Line 1
18	<input checked="" type="checkbox"/>	-35..92.5 °C	U01_Room Temperature	0: AI	101	degrees_Celsius (62)	Unit 1 - Indoor Unit 1	1	Line 1
19	<input checked="" type="checkbox"/>	0-No Error, X-Error(0..255)	U01_Unit Error Code	0: AI	102	no_units (95)	Unit 1 - Indoor Unit 1	1	Line 1
20	<input checked="" type="checkbox"/>	0-No Error, 1-Error	U01_Communication Error IU	3: BI	102	-	Unit 1 - Indoor Unit 1	1	Line 1
21	<input checked="" type="checkbox"/>	0-Unlock, 1-Lock	U01_Remote control lock_S	3: BI	103	-	Unit 1 - Indoor Unit 1	1	Line 1
22	<input checked="" type="checkbox"/>	0-Unlock, 1-Lock	U01_Remote control lock_C	4: BO	102	-	Unit 1 - Indoor Unit 1	1	Line 1
23	<input checked="" type="checkbox"/>	0-Not force, 1-Force	U01_Operating mode force_S	3: BI	104	-	Unit 1 - Indoor Unit 1	1	Line 1
24	<input checked="" type="checkbox"/>	0-Not force, 1-Force	U01_Operating mode force_C	4: BO	103	-	Unit 1 - Indoor Unit 1	1	Line 1
25	<input checked="" type="checkbox"/>	0-Off, 1-On	U02_On/Off_S	3: BI	200	-	Unit 2 - Indoor Unit 2	2	Line 1
26	<input checked="" type="checkbox"/>	0-Off, 1-On	U02_On/Off_C	4: BO	200	-	Unit 2 - Indoor Unit 2	2	Line 1
27	<input checked="" type="checkbox"/>	1-Heat, 2-Cool, 3-Fan, 4-Dry, 5-Auto	U02_Mode_S	13: MI	200	-	Unit 2 - Indoor Unit 2	2	Line 1
28	<input checked="" type="checkbox"/>	1-Heat, 2-Cool, 3-Fan, 4-Dry, 5-Auto	U02_Mode_C	14: MO	200	-	Unit 2 - Indoor Unit 2	2	Line 1
29	<input checked="" type="checkbox"/>	17..30 °C	U02_Setpoint_S	0: AI	200	degrees_Celsius (62)	Unit 2 - Indoor Unit 2	2	Line 1
30	<input checked="" type="checkbox"/>	17..30 °C	U02_Setpoint_C	1: AO	200	degrees_Celsius (62)	Unit 2 - Indoor Unit 2	2	Line 1
31	<input checked="" type="checkbox"/>	1-Auto, 2-Low, 3-Med, 4-High	U02_FanSpeed_S	13: MI	201	-	Unit 2 - Indoor Unit 2	2	Line 1
32	<input checked="" type="checkbox"/>	1-Auto, 2-Low, 3-Med, 4-High	U02_FanSpeed_C	14: MO	201	-	Unit 2 - Indoor Unit 2	2	Line 1
33	<input checked="" type="checkbox"/>	0-Swing Off, 1-Swing On	U02_Vane Position_S	3: BI	201	-	Unit 2 - Indoor Unit 2	2	Line 1
34	<input checked="" type="checkbox"/>	0-Swing Off, 1-Swing On	U02_Vane Position_C	4: BO	201	-	Unit 2 - Indoor Unit 2	2	Line 1
35	<input checked="" type="checkbox"/>	-35..92.5 °C	U02_Room Temperature	0: AI	201	degrees_Celsius (62)	Unit 2 - Indoor Unit 2	2	Line 1
36	<input checked="" type="checkbox"/>	0-No Error, X-Error(0..255)	U02_Unit Error Code	0: AI	202	no_units (95)	Unit 2 - Indoor Unit 2	2	Line 1
37	<input checked="" type="checkbox"/>	0-No Error, 1-Error	U02_Communication Error IU	3: BI	202	-	Unit 2 - Indoor Unit 2	2	Line 1
38	<input checked="" type="checkbox"/>	0-Unlock, 1-Lock	U02_Remote control lock_S	3: BI	203	-	Unit 2 - Indoor Unit 2	2	Line 1
39	<input checked="" type="checkbox"/>	0-Unlock, 1-Lock	U02_Remote control lock_C	4: BO	202	-	Unit 2 - Indoor Unit 2	2	Line 1
40	<input checked="" type="checkbox"/>	0-Not force, 1-Force	U02_Operating mode force_S	3: BI	204	-	Unit 2 - Indoor Unit 2	2	Line 1

Figure 7.8 Intesis MAPS Signals tab

7.2.7 Sending the configuration to Intesis

When the configuration is finished, follow the next steps.

- 1.- Save the project (Menu option **Project->Save**) on your hard disk (more information in Intesis MAPS User Manual).
- 2.- Go to tab 'Receive / Send' of MAPS, and in **Send** section, press **Send** button. Intesis will reboot automatically once the new configuration is loaded.

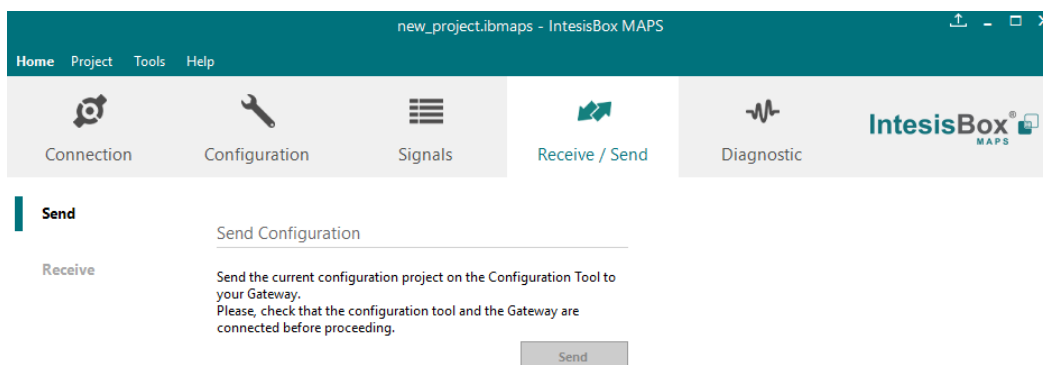

Figure 7.9 Intesis MAPS Receive/Send tab

After any configuration change, do not forget to send the configuration file to the Intesis using button **Send File**.

7.2.8 Diagnostic

To help integrators in the commissioning tasks and troubleshooting, the Configuration Tool offers some specific tools and viewers.

In order to start using the diagnostic tools, connection with the Gateway is required.

The Diagnostic section is composed by two main parts: Tools and Viewers.

- **Tools**

Use the tools section to check the current hardware status of the box, log communications into compressed files to be sent to the support, change the Diagnostic panels' view or send commands to the gateway.

- **Viewers**

In order to check the current status, viewer for the Internal and External protocols are available. It is also available a generic Console viewer for general information about communications and the gateway status and finally a Signals Viewer to simulate the BMS behavior or to check the current values in the system.

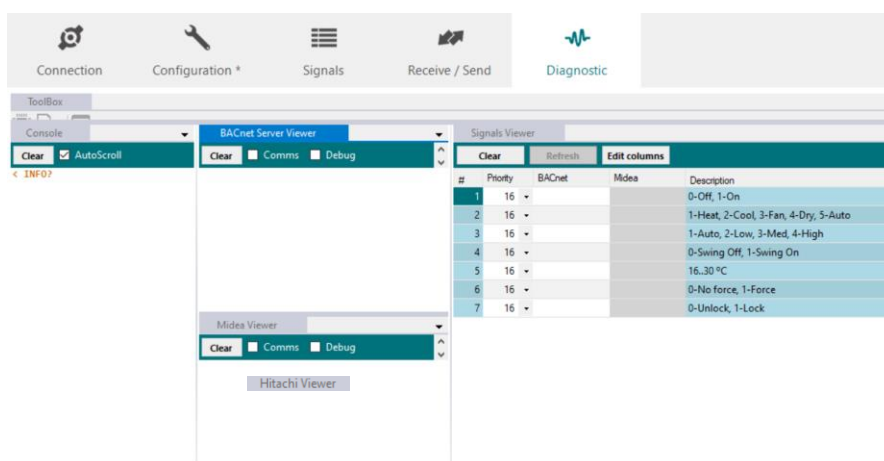

Figure 7.10 Diagnostic

More information about the Diagnostic section can be found in the Configuration Tool manual.

7.2.9 Set-up procedure

1. Install Intesis MAPS on your laptop, use the setup program supplied for this and follow the instructions given by the Installation wizard.
2. Install Intesis in the desired installation site. Installation can be on DIN rail or on a stable not vibrating surface (DIN rail mounted inside a metallic industrial cabinet connected to ground is recommended).
3. If using BACnet IP, connect the communication cable coming from the BACnet IP network to the port marked as Ethernet on Intesis. See more connection details in **6 CONNECTIONS**.

If using BACnet MSTP, connect the communication cables coming from the BACnet MSTP network to the port marked as Port B on Intesis.

4. Connect the communication cable coming from the Midea outdoor unit to the port marked as Port A of Intesis.
5. Power up Intesis. The supply voltage can be 9 to 30 Vdc or just 24 Vac. Take care of the polarity of the supply voltage applied.

WARNING! In order to avoid earth loops that can damage Intesis and/or any other equipment connected to it, we strongly recommend:

- The use of DC power supplies, floating or with the negative terminal connected to earth. **Never use a DC power supply with the positive terminal connected to earth.**
- The use of AC power supplies only if they are floating and not powering any other device.

6. If you want to connect using IP, connect the Ethernet cable from the laptop PC to the port marked as Ethernet of Intesis.

If you want to connect using USB, connect the USB cable from the laptop PC to the port marked as Console of Intesis.

7. Open Intesis MAPS, create a new project selecting a copy of the one named **INBACMID0041000**.
8. Modify the configuration as desired, save it and download the configuration file to Intesis as explained in the Intesis MAPS user manual.
9. Visit the Diagnostic section and check that there is communication activity, some TX frames and some other RX frames. This means that the communication with the BACnet master device and Midea installation is OK. In case there is no communication activity between Intesis and the BACnet and/or Midea units, check that those are operative: check communication cable used to connect all devices and any other communication parameter.

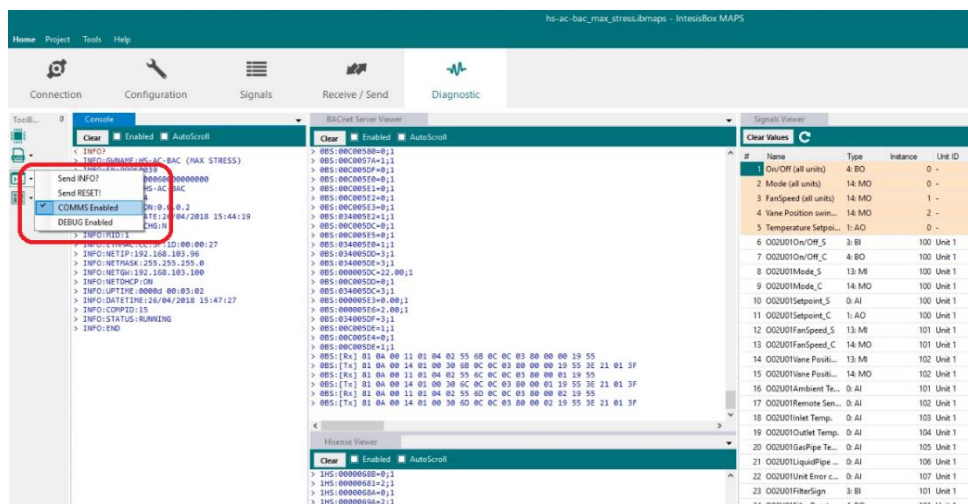

Figure 7.11 Enable COMMS

8 Electrical & Mechanical Features



Enclosure	Plastic, type PC (UL 94 V-0) Net dimensions (d×w×h): 90x88x56 mm Recommended space for installation (d×w×h): 130x100x100mm Color: Light Grey. RAL 7035	Battery	Size: Coin 20mm x 3.2mm Capacity: 3V / 225mAh Type: Manganese Dioxide Lithium
Mounting	Wall. DIN rail EN60715 TH35.	Console Port	Mini Type-B USB 2.0 compliant 1500VDC isolation
Terminal Wiring (for power supply and low-voltage signals)	Per terminal: solid wires or stranded wires (twisted or with ferrule) 1 core: 0.5mm ² ... 2.5mm ² 2 cores: 0.5mm ² ... 1.5mm ² 3 cores: not permitted	USB port	Type-A USB 2.0 compliant Only for USB flash storage device (<i>USB pen drive</i>) Power consumption limited to 150mA (<i>HDD connection not allowed</i>)
Power	1 x Plug-in screw terminal block (3 poles) 9 to 36VDC +/-10%, Max.: 140mA. 24VAC +/-10% 50-60Hz, Max.: 127mA Recommended: 24VDC	Push Button	Button A: Not used Button B: Sends I-Am message to all BACnet ports
Ethernet	1 x Ethernet 10/100 Mbps RJ45 2 x Ethernet LED: port link and activity	Operation Temperature	0°C to +60°C
Port A	1 x Midea XY Plug-in screw terminal block orange (2 poles) 1500VDC isolation from other ports 1 x Plug-in screw terminal block green (2 poles) Reserved for future use	Operational Humidity	5 to 95%, no condensation
Switch A (SWA)	1 x DIP-Switch for serial EIA485 configuration: Reserved for future use	Protection	IP20 (IEC60529)
PORT B	1 x Serial EIA232 (SUB-D9 male connector) <i>Not used</i> 1 x Serial EIA485 Plug-in screw terminal block (3 poles) A, B, SGND (Reference ground or shield) 1500VDC isolation from other ports	LED Indicators	10 x On board LED indicators 1 x Error LED 1 x Power LED 2 x Ethernet Link/Speed 2 x Port A TX/RX 2 x Port B TX/RX 1 x Button A indicator 1 x Button B indicator
Switch B (SWB)	1 x DIP-Switch for serial EIA485 configuration: Position 1: ON: 120 Ω termination active Off: 120 Ω termination inactive Position 2-3: ON: Polarization active Off: Polarization inactive		

9 Dimensions

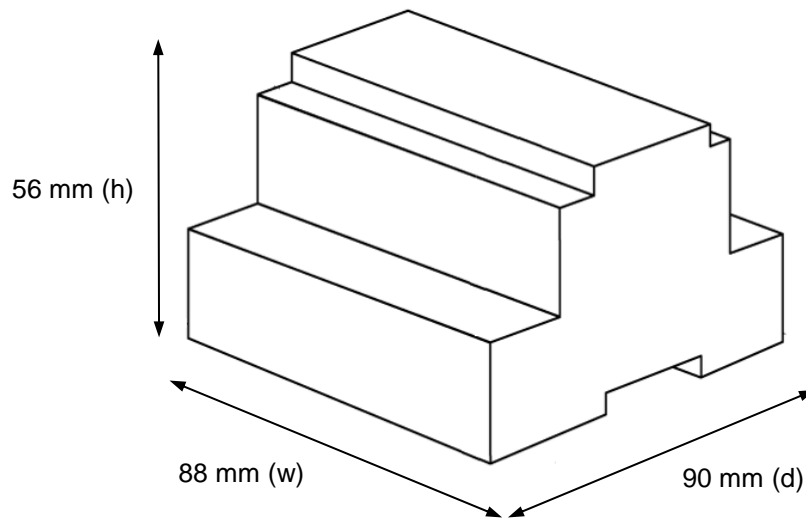

Recommended available space for its installation into a cabinet (wall or DIN rail mounting), with space enough for external connections

