

BACnet Server

Samsung NASA compatible Outdoor Units

USER MANUAL

Issue date: 01/2022 r1.3 ENGLISH

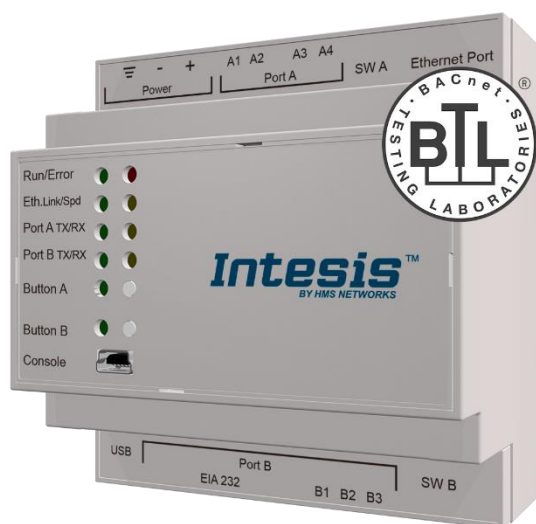

Important User Information

Disclaimer

The information in this document is for informational purposes only. Please inform HMS Industrial Networks of any inaccuracies or omissions found in this document. HMS Industrial Networks disclaims any responsibility or liability for any errors that may appear in this document.

HMS Industrial Networks reserves the right to modify its products in line with its policy of continuous product development. The information in this document shall therefore not be construed as a commitment on the part of HMS Industrial Networks and is subject to change without notice. HMS Industrial Networks makes no commitment to update or keep current the information in this document.

The data, examples and illustrations found in this document are included for illustrative purposes and are only intended to help improve understanding of the functionality and handling of the product. In view of the wide range of possible applications of the product, and because of the many variables and requirements associated with any particular implementation, HMS Industrial Networks cannot assume responsibility or liability for actual use based on the data, examples or illustrations included in this document nor for any damages incurred during installation of the product. Those responsible for the use of the product must acquire sufficient knowledge in order to ensure that the product is used correctly in their specific application and that the application meets all performance and safety requirements including any applicable laws, regulations, codes and standards. Further, HMS Industrial Networks will under no circumstances assume liability or responsibility for any problems that may arise as a result from the use of undocumented features or functional side effects found outside the documented scope of the product. The effects caused by any direct or indirect use of such aspects of the product are undefined and may include e.g. compatibility issues and stability issues.

Gateway for the integration of Samsung NASA compatible systems into BACnet/IP or BACnet MSTP control and monitoring systems.

ORDER CODES	LEGACY ORDER CODES
INBACSAM004O000	SM-ACN-BAC-4
INBACSAM008O000	SM-ACN-BAC-8
INBACSAM016O000	SM-ACN-BAC-16
INBACSAM064O000	SM-ACN-BAC-64

INDEX

1	Description	8
1.1	Introduction	8
1.1	Functionality	9
1.2	Capacity of Intesis	10
2	Protocol Implementation Conformance Statement	11
2.1	BACnet Standardized Device Profile (Annex L):	11
2.2	Segmentation Capability:	11
2.3	Data Link Layer Options:	11
2.4	Device Address Binding:	12
2.5	Networking Options:	12
2.6	Character Sets Supported	12
2.7	Gateway	12
3	BACnet Interoperability Building Blocks Supported (BIBBs)	13
3.1	Data Sharing BIBBs	13
3.2	Alarm and Event Management BIBBs	13
3.3	Scheduling BIBBs	14
3.4	Trending BIBBs	14
3.5	Network Management BIBBs	14
3.6	Device Management BIBBs	15
4	Service Types	16
5	Objects	17
5.1	Supported Object Types	17
5.2	Member objects	19
5.2.1	Type: Gateway	19
5.2.2	Type: Central control	19
5.2.3	Type: Indoor Unit	19
5.2.4	Type: HE	20
5.2.5	Type: HT	20
5.2.6	Type: EHS	21
5.2.7	Type: AHU	21
5.2.8	Type: ERV	22
5.2.9	Type: ERV+	22
5.2.10	Type: CHILLER	22
5.3	Objects and properties	23
5.3.1	Device INBACSAM--O000 (Device Object Type)	24
5.3.2	OUxx_Communication Error OU (Binary Input Object Type)	26
5.3.3	OU Addressing Error (Binary Input Object Type)	27
5.3.4	On/Off (all units) (Binary Output Object Type)	28

5.3.5	Mode (all units) (Multistate Output Object Type)	29
5.3.6	FanSpeed (all units) (Multistate Input Object Type)	31
5.3.7	Vane position swing (all units) (Binary Output Object Type)	32
5.3.8	Temperature Setpoint (all units) (Analog Output Object Type)	33
5.3.9	Vent. On/Off (all units) (Binary Output Object Type)	34
5.3.10	Hot Water On/Off (all units) (Binary Output Object Type)	35
5.3.11	OxxUxx_On/Off_S (Binary Input Object Type)	36
5.3.12	OxxUxx_On/Off_C (Binary Output Object Type)	37
5.3.13	OxxUxx_Mode IU/AHU_S (Multistate Input Object Type)	38
5.3.14	OxxUxx_Mode HE/EHS_S (Multistate Input Object Type)	39
5.3.15	OxxUxx_Mode ERV+_S (Multistate Input Object Type)	40
5.3.16	OxxUxx_Mode CHILLER_S (Multistate Input Object Type)	41
5.3.17	OxxUxx_Mode IU/AHU_C (Multistate Output Object Type)	42
5.3.18	OxxUxx_Mode HE/EHS_C (Multistate Output Object Type)	44
5.3.19	OxxUxx_Mode ERV+_C (Multistate Output Object Type)	46
5.3.20	OxxUxx_Mode CHILLER_C (Multistate Input Object Type)	48
5.3.21	OxxUxx_Setpoint_S (Analog Input Object Type)	50
5.3.22	OxxUxx_Setpoint_C (Analog Output Object Type)	51
5.3.23	OxxUxx_FanSpeed_S (Multistate Input Object Type)	52
5.3.24	OxxUxx_FanSpeed_C (Multistate Output Object Type)	53
5.3.25	OxxUxx_Vane position swing_S (Binary Input Object Type)	54
5.3.26	OxxUxx_Vane position swing_C (Binary Output Object Type)	55
5.3.27	OxxUxx_Room_Temperature (Analog Input Object Type)	56
5.3.28	OxxUxx_Disch.Setpoint Cool IU_S (Analog Input Object Type)	57
5.3.29	OxxUxx_Disch.Setpoint Cool IU_C (Analog Output Object Type)	58
5.3.30	OxxUxx_Disch.Setpoint Cool AHU_S (Analog Input Object Type)	59
5.3.31	OxxUxx_Disch.Setpoint Cool AHU_C (Analog Output Object Type)	60
5.3.32	OxxUxx_Disch.Setpoint Heat IU_S (Analog Input Object Type)	61
5.3.33	OxxUxx_Disch.Setpoint Heat IU_C (Analog Output Object Type)	62
5.3.34	OxxUxx_Disch.Setpoint Heat AHU_S (Analog Input Object Type)	63
5.3.35	OxxUxx_Disch.Setpoint Heat IU_C (Analog Output Object Type)	64
5.3.36	OxxUxx_Disch. Current Temp. S (Analog Input Object Type)	65
5.3.37	OxxUxx_Unit Error code (Analog Input Object Type)	66
5.3.38	OxxUxx_Error Slave Chiller Unit (Analog Input Object Type)	67
5.3.39	OxxUxx_Slave Chiller in Error (Analog Input Object Type)	68
5.3.40	OxxUxx_FilterSign (Binary Input Object Type)	69
5.3.41	OxxUxx_FilterReset (Binary Output Object Type)	70
5.3.42	OxxUxx_Communication Status (Multistate Input Object Type)	71
5.3.43	OxxUxx_RC Restriction_S (Binary Input Object Type)	73
5.3.44	OxxUxx_RC Restriction_C (Binary Output Object Type)	74

5.3.45	OxxUxx_Buzzer Sound (Binary Output Object Type)	75
5.3.46	OxxUxx_Unit type (Multistate Input Object Type)	76
5.3.47	OxxUxx_HotWater On/Off_S (Binary Input Object Type)	78
5.3.48	OxxUxx_HotWater On/Off_C (Binary Output Object Type)	79
5.3.49	OxxUxx_HotWater Mode HE/HT_S (Multistate Input Object Type)	80
5.3.50	OxxUxx_HotWater Mode EHS_S (Multistate Input Object Type)	81
5.3.51	OxxUxx_HotWater Mode HE/HT_C (Multistate Output Object Type)	82
5.3.52	OxxUxx_HotWater Mode EHS_C (Multistate Output Object Type)	83
5.3.53	OxxUxx_HotWater Setpoint HE_S (Analog Input Object Type)	84
5.3.54	OxxUxx_HotWater Setpoint HT_S (Analog Input Object Type)	85
5.3.55	OxxUxx_HotWater Setpoint EHS_S (Analog Input Object Type)	86
5.3.56	OxxUxx_HotWater Setpoint HE_C (Analog Output Object Type)	87
5.3.57	OxxUxx_HotWater Setpoint EHS_C (Analog Output Object Type)	88
5.3.58	OxxUxx_HotWater Current Temp. (Analog Input Object Type)	88
5.3.59	OxxUxx_WaterIn Temperature. (Analog Input Object Type)	90
5.3.60	OxxUxx_WaterOut Temperature. (Analog Input Object Type)	91
5.3.61	OxxUxx_WaterOut Setpoint HE_S. (Analog Input Object Type)	92
5.3.62	OxxUxx_WaterOut Setpoint HT_S. (Analog Input Object Type)	93
5.3.63	OxxUxx_WaterOut Setpoint EHS_S. (Analog Input Object Type)	94
5.3.64	OxxUxx_WaterOut Setpoint CHILL_S (Analog Input Object Type)	94
5.3.65	OxxUxx_WaterOut Setpoint HE_C (Analog Output Object Type)	96
5.3.66	OxxUxx_WaterOut Setpoint HT_C (Analog Output Object Type)	97
5.3.67	OxxUxx_WaterOut Setpoint EHS_C (Analog Output Object Type)	98
5.3.68	OxxUxx_WaterOut Setpoint CHILL_C (Analog Output Object Type)	99
5.3.69	OxxUxx_WaterOut Average Temp. (Analog Input Object Type)	100
5.3.70	OxxUxx_Vent. On/Off_S (Binary Input Object Type)	101
5.3.71	OxxUxx_HotWater On/Off_C (Binary Output Object Type)	102
5.3.72	OxxUxx_Vent. Mode_S (Multistate Input Object Type)	103
5.3.73	OxxUxx_Vent. Mode_C (Multistate Output Object Type)	104
5.3.74	OxxUxx_Vent. FanSpeed_S (Multistate Input Object Type)	105
5.3.75	OxxUxx_Vent. FanSpeed_C (Multistate Output Object Type)	106
5.3.76	OxxUxx_WindFree_S (Binary Input Object Type)	107
5.3.77	OxxUxx_WindFree_C (Binary Output Object Type)	108
5.3.78	OxxUxx_Air_Clean_S (Binary Input Object Type)	109
5.3.79	OxxUxx_Air_Clean_C (Binary Output Object Type)	110
5.3.80	OxxUxx_360_CST_Air_Flow_S (Multistate Input Object Type)	111
5.3.81	OxxUxx_360_CST_Air_Flow_C (Multistate Output Object Type)	112

6	Connections	113
6.1	Power device	114
6.2	Connection to BACnet	114
6.2.1	BACnet IP	114
6.2.2	BACnet MSTP	114
6.3	Connect to Samsung NASA installation	114
6.4	Connection to the configuration tool	115
7	Set-up process and troubleshooting	116
7.1	Pre-requisites	116
7.2	Intesis MAPS. Configuration & monitoring tool for Intesis BACnet series	116
7.2.1	Introduction	116
7.2.2	Connection	116
7.2.3	Configuration tab	117
7.2.4	BACnet Server configuration	117
7.2.5	Samsung NASA configuration	118
7.2.6	Signals	120
7.2.7	Sending the configuration to Intesis	121
7.2.8	Diagnostic	121
7.2.9	Set-up procedure	123
8	Electrical & Mechanical Features	125
9	Dimensions	126
10	AC Unit Types compatibility	127

1 Description

1.1 Introduction

This document describes the integration of Samsung NASA compatible air conditioning systems into BACnet compatible devices and systems using gateway *Intesis BACnet Server – Samsung NASA*.

The aim of this integration is to monitor and control your Samsung air conditioning system, remotely, from your Control Center using any commercial SCADA or monitoring software that includes a BACnet/IP or BACnet MSTP driver. To do it so, Intesis allows BACnet/IP and BACnet MSTP communication, acting as a server (B-AAC profile), allowing polling or subscription requests (COV).

Intesis makes available the Samsung air conditioning system indoor units through independent BACnet objects.

Abstraction of Samsung air conditioning system properties and functionalities as fixed BACnet Objects. Intesis allows fixed BACnet object IDs mapping. Simple configuration is needed: just select the appropriate communication parameters (IP address, baud rate...).

Up to 64 indoor units supported, depending on product version.

This document assumes that the user is familiar with BACnet and Samsung technologies and their technical terms.

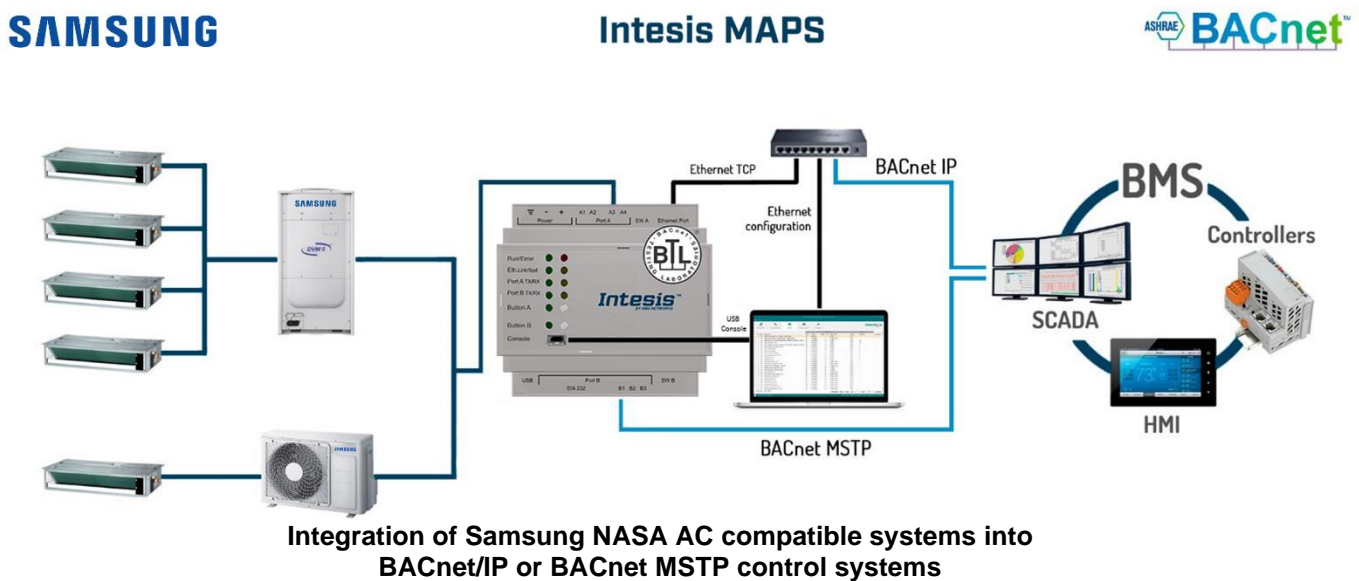

NOTE: Take following considerations into account for Samsung's NASA R1/R2 network:



- Samsung NASA AC network allows for both automatic and manual addressing. **Manual addressing of both indoor and outdoor units must be setup by Samsung installer in order that Intesis communicates properly.** Manual addressing is setup by means of DIP switches in outdoor unit and using the remote controller or DIP switches in the indoor unit.
- Samsung NASA indoor units **need to be configured to accept 'central control'**. To do so, they need to be configured with so-called 'installation option code' in which segment 5 of this code needs to be set to value '1' to allow central control.

1.1 Functionality

Intesis™ continuously monitors Samsung's NASA R1/R2 network for all configured signals and keeps the updated status of all of them in its memory, ready to be served when requested from the BACnet side.

Commands toward the R1/R2 indoor unit communication adaptor are permitted.

Each indoor unit is offered in set of BACnet objects.

Element	Object supported
Outdoor Unit	<ul style="list-style-type: none">• Communication status• Addressing status
Indoor Unit	<ul style="list-style-type: none">• Status• Command• Communication status
General signals (all units)	<ul style="list-style-type: none">• Command

1.2 Capacity of Intesis

Element	Max.	Notes
Number of indoor units	64 *	Number of indoor units that can be controlled through Intesis
Number of Objects	3224 *	Number of Samsung NASA objects available into Intesis.

* There are different models of *Intesis BACnet Server – Samsung NASA AC* each one with different capacity. The table above shows the capacity for the top model (with maximum capacity).

Their order codes are:

- INBACSAM004O000: Model supporting up to 4 indoor units
- INBACSAM008O000: Model supporting up to 8 indoor units
- INBACSAM016O000: Model supporting up to 16 indoor units
- INBACSAM064O000: Model supporting up to 64 indoor units

2 Protocol Implementation Conformance Statement

BACnet Protocol Implementation Conformance Statement (PICS)

Date: 2017-10-26

Vendor Name: HMS Industrial Networks S.L.U

Product Name: Intesis-BACnet-Samsung AC

Product Model Number: INBACSAM---0000

Application Software Version: 0.0.0.2

Firmware Revision: 12.1.0.3

BACnet Protocol Revision: 12

Product Description:

SAMSUNG to BACnet Gateway

Abstraction of Samsung air conditioning system properties and functionalities as BACnet Objects.
Capacity of 4, 8, 16 or 64 indoor units depending on product version.

2.1 BACnet Standardized Device Profile (Annex L):

- BACnet Operator Workstation (B-OWS)
- BACnet Building Controller (B-BC)
- BACnet Advanced Application Controller (B-AAC)
- BACnet Application Specific Controller (B-ASC)
- BACnet Smart Sensor (B-SS)
- BACnet Smart Actuator (B-SA)

Additional BACnet Interoperability Building Blocks Supported (Annex K):
Reference of BIBBs List

2.2 Segmentation Capability:

Segmented request supported	<input type="checkbox"/> No	<input checked="" type="checkbox"/> Yes	Window Size <u>16</u>
Segmented responses supported	<input type="checkbox"/> No	<input checked="" type="checkbox"/> Yes	Window Size <u>16</u>

2.3 Data Link Layer Options:

- BACnet IP, (Annex J)
- BACnet IP, (Annex J), Foreign Device
- ISO 8802-3, Ethernet (Clause 7)
- ANSI/ATA 878.1, 2.5 Mb. ARCNET (Clause 8)
- ANSI/ATA 878.1, RS-485 ARCNET (Clause 8), baud rate(s) _____
- MS/TP master (Clause 9), baud rate(s): 9600, 19200, 38400, 57600, 76800, 115200
- MS/TP slave (Clause 9), baud rate(s): _____
- Point-To-Point, EIA 232 (Clause 10), baud rate(s): _____
- Point-To-Point, modem, (Clause 10), baud rate(s): _____
- LonTalk, (Clause 11), medium: _____
- Other: _____

2.4 Device Address Binding:

Is static device binding supported? (This is currently necessary for two-way communication with MS/TP slaves and certain other devices.) Yes No

2.5 Networking Options:

- Router, Clause 6 - List all routing configurations, e.g., ARCNET-Ethernet, Ethernet-MS/TP, etc.
- Annex H, BACnet Tunneling Router over IP
- BACnet/IP Broadcast Management Device (BBMD)
Does the BBMD support registrations by Foreign Devices? Yes No

2.6 Character Sets Supported

Indicating support for multiple character sets does not imply that they can all be supported simultaneously.

- ISO 10646 (UTF-8)
- IBM™/Microsoft™ DBCS
- ISO 8859-1
- ISO 10646 (UCS-2)
- ISO 10646 (UCS-4)
- JIS X 0208

2.7 Gateway

If this product is a communication gateway, describe the types of non-BACnet equipment/network(s) that the gateway supports:

Samsung NASA Air Conditioning System

3 BACnet Interoperability Building Blocks Supported (BIBBs)

3.1 Data Sharing BIBBs

BIBB Type		Active	BACnet Service	Initiate	Execute
DS-RP-A	Data Sharing-ReadProperty-A	<input type="checkbox"/>	ReadProperty	<input checked="" type="checkbox"/>	<input type="checkbox"/>
DS-RP-B	Data Sharing-ReadProperty-B	<input checked="" type="checkbox"/>	ReadProperty	<input type="checkbox"/>	<input checked="" type="checkbox"/>
DS-RPM-A	Data Sharing-ReadPropertyMultiple-A	<input type="checkbox"/>	ReadPropertyMultiple	<input checked="" type="checkbox"/>	<input type="checkbox"/>
DS-RPM-B	Data Sharing-ReadPropertyMultiple-B	<input checked="" type="checkbox"/>	ReadPropertyMultiple	<input type="checkbox"/>	<input checked="" type="checkbox"/>
DS-RPC-A	Data Sharing-ReadPropertyConditional-A	<input type="checkbox"/>	ReadPropertyConditional	<input checked="" type="checkbox"/>	<input type="checkbox"/>
DS-RPC-B	Data Sharing-ReadPropertyConditional-B	<input type="checkbox"/>	ReadPropertyConditional	<input type="checkbox"/>	<input checked="" type="checkbox"/>
DS-WP-A	Data Sharing-WriteProperty-A	<input type="checkbox"/>	WriteProperty	<input checked="" type="checkbox"/>	<input type="checkbox"/>
DS-WP-B	Data Sharing-WriteProperty-B	<input checked="" type="checkbox"/>	WriteProperty	<input type="checkbox"/>	<input checked="" type="checkbox"/>
DS-WPM-A	Data Sharing-WritePropertyMultiple-A	<input type="checkbox"/>	WritePropertyMultiple	<input checked="" type="checkbox"/>	<input type="checkbox"/>
DS-WPM-B	Data Sharing-WritePropertyMultiple-B	<input checked="" type="checkbox"/>	WritePropertyMultiple	<input type="checkbox"/>	<input checked="" type="checkbox"/>
DS-COV-A	Data Sharing-COV-A	<input type="checkbox"/>	SubscribeCOV	<input checked="" type="checkbox"/>	<input type="checkbox"/>
		<input type="checkbox"/>	ConfirmedCOVNotification	<input type="checkbox"/>	<input checked="" type="checkbox"/>
		<input type="checkbox"/>	UnconfirmedCOVNotification	<input type="checkbox"/>	<input checked="" type="checkbox"/>
DS-COV-B	Data Sharing-COV-B	<input checked="" type="checkbox"/>	SubscribeCOV	<input type="checkbox"/>	<input checked="" type="checkbox"/>
		<input checked="" type="checkbox"/>	ConfirmedCOVNotification	<input checked="" type="checkbox"/>	<input type="checkbox"/>
		<input checked="" type="checkbox"/>	UnconfirmedCOVNotification	<input checked="" type="checkbox"/>	<input type="checkbox"/>
DS-COVP-A	Data Sharing-COVP-A	<input type="checkbox"/>	SubscribeCOVProperty	<input checked="" type="checkbox"/>	<input type="checkbox"/>
		<input type="checkbox"/>	ConfirmedCOVNotification	<input type="checkbox"/>	<input checked="" type="checkbox"/>
		<input type="checkbox"/>	UnconfirmedCOVNotification	<input type="checkbox"/>	<input checked="" type="checkbox"/>
DS-COVP-B	Data Sharing-COVP-B	<input type="checkbox"/>	SubscribeCOVProperty	<input type="checkbox"/>	<input checked="" type="checkbox"/>
		<input type="checkbox"/>	ConfirmedCOVNotification	<input checked="" type="checkbox"/>	<input type="checkbox"/>
		<input type="checkbox"/>	UnconfirmedCOVNotification	<input checked="" type="checkbox"/>	<input type="checkbox"/>
DS-COVU-A	Data Sharing-COV-Unsubscribed-A	<input type="checkbox"/>	UnconfirmedCOVNotification	<input type="checkbox"/>	<input checked="" type="checkbox"/>
DS-COVU-B	Data Sharing-COV-Unsubscribed-B	<input type="checkbox"/>	UnconfirmedCOVNotification	<input checked="" type="checkbox"/>	<input type="checkbox"/>

3.2 Alarm and Event Management BIBBs

BIBB Type		Active	BACnet Service	Initiate	Execute
AE-N-A	Alarm and Event-Notification-A	<input type="checkbox"/>	ConfirmedEventNotification	<input type="checkbox"/>	<input checked="" type="checkbox"/>
		<input type="checkbox"/>	UnconfirmedEventNotification	<input type="checkbox"/>	<input checked="" type="checkbox"/>
AE-N-I-B	Alarm and Event-Notification Internal-B	<input checked="" type="checkbox"/>	ConfirmedEventNotification	<input checked="" type="checkbox"/>	<input type="checkbox"/>
		<input checked="" type="checkbox"/>	UnconfirmedEventNotification	<input checked="" type="checkbox"/>	<input type="checkbox"/>
AE-N-E-B	Alarm and Event-Notification External-B	<input type="checkbox"/>	ConfirmedEventNotification	<input checked="" type="checkbox"/>	<input type="checkbox"/>
		<input type="checkbox"/>	UnconfirmedEventNotification	<input checked="" type="checkbox"/>	<input type="checkbox"/>
AE-ACK-A	Alarm and Event-ACK-A	<input type="checkbox"/>	AcknowledgeAlarm	<input checked="" type="checkbox"/>	<input type="checkbox"/>
AE-ACK-B	Alarm and Event-ACK-B	<input checked="" type="checkbox"/>	AcknowledgeAlarm	<input type="checkbox"/>	<input checked="" type="checkbox"/>
AE-ASUM-A	Alarm and Event-Alarm Summary-A	<input type="checkbox"/>	GetAlarmSummary	<input checked="" type="checkbox"/>	<input type="checkbox"/>
AE-ASUM-B	Alarm and Event-Alarm Summary-B	<input checked="" type="checkbox"/>	GetAlarmSummary	<input type="checkbox"/>	<input checked="" type="checkbox"/>
AE-ESUM-A	Alarm and Event-Enrollment Summary-A	<input type="checkbox"/>	GetEnrollmentSummary	<input checked="" type="checkbox"/>	<input type="checkbox"/>
AE-ESUM-B	Alarm and Event-Enrollment Summary-B	<input type="checkbox"/>	GetEnrollmentSummary	<input type="checkbox"/>	<input checked="" type="checkbox"/>
AE-INFO-A	Alarm and Event-Information-A	<input type="checkbox"/>	GetEventInformation	<input checked="" type="checkbox"/>	<input type="checkbox"/>
AE-INFO-B	Alarm and Event-Information-B	<input checked="" type="checkbox"/>	GetEventInformation	<input type="checkbox"/>	<input checked="" type="checkbox"/>
AE-LS-A	Alarm and Event-LifeSafety-A	<input type="checkbox"/>	LifeSafetyOperation	<input checked="" type="checkbox"/>	<input type="checkbox"/>
AE-LS-B	Alarm and Event-LifeSafety-B	<input type="checkbox"/>	LifeSafetyOperation	<input type="checkbox"/>	<input checked="" type="checkbox"/>

3.3 Scheduling BIBBs

BIBB Type		Active	BACnet Service	Initiate	Execute
SCHED-A	Scheduling–A (must support DS-RP-A and DS-WP-A)	<input type="checkbox"/>			
SCHED-I-B	Scheduling-Internal–B (shall support DS-RP-B and DS-WP-B) (shall also support ether DM-TS-B or DS-UTC-B)	<input checked="" type="checkbox"/>			
SCHED-E-B	Scheduling-External–B (shall support SCHED-I-B and DS-WP-A)	<input type="checkbox"/>			

3.4 Trending BIBBs

BIBB Type		Active	BACnet Service	Initiate	Execute
T-VMT-A	Trending - Viewing and Modifying Trends–A	<input type="checkbox"/>	ReadRange	<input checked="" type="checkbox"/>	<input type="checkbox"/>
T-VMT-I-B	Trending - Viewing and Modifying Trends Internal–B	<input checked="" type="checkbox"/>	ReadRange	<input type="checkbox"/>	<input checked="" type="checkbox"/>
T-VMT-E-B	Trending - Viewing and Modifying Trends External–B	<input type="checkbox"/>	ReadRange	<input type="checkbox"/>	<input checked="" type="checkbox"/>
T-ATR-A	Trending - Automated Trend Retrieval–A	<input type="checkbox"/>	ConfirmedEventNotification	<input type="checkbox"/>	<input checked="" type="checkbox"/>
		<input type="checkbox"/>	ReadRange	<input checked="" type="checkbox"/>	<input type="checkbox"/>
T-ATR-B	Trending - Automated Trend Retrieval–B	<input checked="" type="checkbox"/>	ConfirmedEventNotification	<input checked="" type="checkbox"/>	<input type="checkbox"/>
		<input checked="" type="checkbox"/>	ReadRange	<input type="checkbox"/>	<input checked="" type="checkbox"/>

3.5 Network Management BIBBs

BIBB Type		Active	BACnet Service	Initiate	Execute
NM-CE-A	Network Management - Connection Establishment–A	<input type="checkbox"/>	Establish-Connection-To-Network	<input checked="" type="checkbox"/>	<input type="checkbox"/>
		<input type="checkbox"/>	Disconnect-Connection-To-Network	<input checked="" type="checkbox"/>	<input type="checkbox"/>
NM-CE-B	Network Management - Connection Establishment– B	<input type="checkbox"/>	Establish-Connection-To-Network	<input type="checkbox"/>	<input checked="" type="checkbox"/>
		<input type="checkbox"/>	Disconnect-Connection-To-Network	<input type="checkbox"/>	<input checked="" type="checkbox"/>
NM-RC-A	Network Management - Router Configuration–A	<input type="checkbox"/>	Who-Is-Router-To-Network	<input checked="" type="checkbox"/>	<input type="checkbox"/>
		<input type="checkbox"/>	I-Am-Router-To-Network	<input type="checkbox"/>	<input checked="" type="checkbox"/>
		<input type="checkbox"/>	I-Could-Be-Router-To-Network	<input type="checkbox"/>	<input checked="" type="checkbox"/>
		<input type="checkbox"/>	Initialize-Routing-Table	<input checked="" type="checkbox"/>	<input type="checkbox"/>
NM-RC-B	Network Management - Router Configuration–B	<input type="checkbox"/>	Initialize-Routing-Table-Ack	<input type="checkbox"/>	<input checked="" type="checkbox"/>
		<input type="checkbox"/>	Who-Is-Router-To-Network	<input checked="" type="checkbox"/>	<input checked="" type="checkbox"/>
		<input type="checkbox"/>	I-Am-Router-To-Network	<input checked="" type="checkbox"/>	<input checked="" type="checkbox"/>
		<input type="checkbox"/>	Initialize-Routing-Table	<input type="checkbox"/>	<input checked="" type="checkbox"/>
		<input type="checkbox"/>	Initialize-Routing-Table-Ack	<input checked="" type="checkbox"/>	<input type="checkbox"/>

3.6 Device Management BIBBs

BIBB Type		Active	BACnet Service	Initiate	Execute
DM-DDB-A	Device Management - Dynamic Device Binding–A	<input checked="" type="checkbox"/>	Who-Is	<input checked="" type="checkbox"/>	<input type="checkbox"/>
		<input checked="" type="checkbox"/>	I-Am	<input type="checkbox"/>	<input checked="" type="checkbox"/>
DM-DDB-B	Device Management - Dynamic Device Binding–B	<input checked="" type="checkbox"/>	Who-Is	<input type="checkbox"/>	<input checked="" type="checkbox"/>
		<input checked="" type="checkbox"/>	I-Am	<input checked="" type="checkbox"/>	<input type="checkbox"/>
DM-DOB-A	Device Management - Dynamic Object Binding–A	<input type="checkbox"/>	Who-Has	<input checked="" type="checkbox"/>	<input type="checkbox"/>
		<input type="checkbox"/>	I-Have	<input type="checkbox"/>	<input checked="" type="checkbox"/>
DM-DOB-B	Device Management - Dynamic Object Binding–B	<input checked="" type="checkbox"/>	Who-Has	<input type="checkbox"/>	<input checked="" type="checkbox"/>
		<input checked="" type="checkbox"/>	I-Have	<input checked="" type="checkbox"/>	<input type="checkbox"/>
DM-DCC-A	Device Management - DeviceCommunicationControl–A	<input type="checkbox"/>	DeviceCommunicationControl	<input checked="" type="checkbox"/>	<input type="checkbox"/>
DM-DCC-B	Device Management - DeviceCommunicationControl–B	<input checked="" type="checkbox"/>	DeviceCommunicationControl	<input type="checkbox"/>	<input checked="" type="checkbox"/>
DM-PT-A	Device Management - PrivateTransfer–A	<input type="checkbox"/>	ConfirmedPrivateTransfer	<input checked="" type="checkbox"/>	<input type="checkbox"/>
		<input type="checkbox"/>	UnconfirmedPrivateTransfer	<input checked="" type="checkbox"/>	<input type="checkbox"/>
DM-PT-B	Device Management - PrivateTransfer–B	<input type="checkbox"/>	ConfirmedPrivateTransfer	<input type="checkbox"/>	<input checked="" type="checkbox"/>
		<input type="checkbox"/>	UnconfirmedPrivateTransfer	<input type="checkbox"/>	<input checked="" type="checkbox"/>
DM-TM-A	Device Management - Text Message–A	<input type="checkbox"/>	ConfirmedTextMessage	<input checked="" type="checkbox"/>	<input type="checkbox"/>
		<input type="checkbox"/>	UnconfirmedTextMessage	<input checked="" type="checkbox"/>	<input type="checkbox"/>
DM-TM-B	Device Management - Text Message–B	<input type="checkbox"/>	ConfirmedTextMessage	<input type="checkbox"/>	<input checked="" type="checkbox"/>
		<input type="checkbox"/>	UnconfirmedTextMessage	<input type="checkbox"/>	<input checked="" type="checkbox"/>
DM-TS-A	Device Management - TimeSynchronization–A	<input type="checkbox"/>	TimeSynchronization	<input checked="" type="checkbox"/>	<input type="checkbox"/>
DM-TS-B	Device Management - TimeSynchronization–B	<input checked="" type="checkbox"/>	TimeSynchronization	<input type="checkbox"/>	<input checked="" type="checkbox"/>
DM-UTC-A	Device Management - UTCTimeSynchronization–A	<input type="checkbox"/>	UTCTimeSynchronization	<input checked="" type="checkbox"/>	<input type="checkbox"/>
DM-UTC-B	Device Management - UTCTimeSynchronization–B	<input type="checkbox"/>	UTCTimeSynchronization	<input type="checkbox"/>	<input checked="" type="checkbox"/>
DM-RD-A	Device Management - ReinitializeDevice–A	<input type="checkbox"/>	ReinitializeDevice	<input checked="" type="checkbox"/>	<input type="checkbox"/>
DM-RD-B	Device Management - ReinitializeDevice–B	<input checked="" type="checkbox"/>	ReinitializeDevice	<input type="checkbox"/>	<input checked="" type="checkbox"/>
DM-BR-A	Device Management - Backup and Restore–A	<input type="checkbox"/>	AtomicReadFile	<input checked="" type="checkbox"/>	<input type="checkbox"/>
		<input type="checkbox"/>	AtomicWriteFile	<input checked="" type="checkbox"/>	<input type="checkbox"/>
		<input type="checkbox"/>	CreateObject	<input checked="" type="checkbox"/>	<input type="checkbox"/>
		<input type="checkbox"/>	ReinitializeDevice	<input checked="" type="checkbox"/>	<input type="checkbox"/>
DM-BR-B	Device Management - Backup and Restore–B	<input type="checkbox"/>	AtomicReadFile	<input type="checkbox"/>	<input checked="" type="checkbox"/>
		<input type="checkbox"/>	AtomicWriteFile	<input type="checkbox"/>	<input checked="" type="checkbox"/>
		<input type="checkbox"/>	ReinitializeDevice	<input type="checkbox"/>	<input checked="" type="checkbox"/>
DM-R-A	Device Management - Restart–A	<input type="checkbox"/>	UnconfirmedCOVNotification	<input type="checkbox"/>	<input checked="" type="checkbox"/>
DM-R-B	Device Management - Restart–B	<input type="checkbox"/>	UnconfirmedCOVNotification	<input checked="" type="checkbox"/>	<input type="checkbox"/>
DM-LM-A	Device Management - List Manipulation–A	<input type="checkbox"/>	AddListElement	<input checked="" type="checkbox"/>	<input type="checkbox"/>
		<input type="checkbox"/>	RemoveListElement	<input checked="" type="checkbox"/>	<input type="checkbox"/>
DM-LM-B	Device Management - List Manipulation–B	<input type="checkbox"/>	AddListElement	<input type="checkbox"/>	<input checked="" type="checkbox"/>
		<input type="checkbox"/>	RemoveListElement	<input type="checkbox"/>	<input checked="" type="checkbox"/>
DM-OCD-A	Device Management - Object Creation and Deletion–A	<input type="checkbox"/>	CreateObject	<input checked="" type="checkbox"/>	<input type="checkbox"/>
		<input type="checkbox"/>	DeleteObject	<input checked="" type="checkbox"/>	<input type="checkbox"/>
DM-OCD-B	Device Management - Object Creation and Deletion–B	<input type="checkbox"/>	CreateObject	<input type="checkbox"/>	<input checked="" type="checkbox"/>
		<input type="checkbox"/>	DeleteObject	<input type="checkbox"/>	<input checked="" type="checkbox"/>
DM-VT-A	Device Management - Virtual Terminal–A	<input type="checkbox"/>	VT-Open	<input checked="" type="checkbox"/>	<input type="checkbox"/>
		<input type="checkbox"/>	VT-Close	<input checked="" type="checkbox"/>	<input checked="" type="checkbox"/>
		<input type="checkbox"/>	VT-Data	<input checked="" type="checkbox"/>	<input checked="" type="checkbox"/>
DM-VT-B	Device Management - Virtual Terminal–B	<input type="checkbox"/>	VT-Open	<input type="checkbox"/>	<input checked="" type="checkbox"/>
		<input type="checkbox"/>	VT-Close	<input checked="" type="checkbox"/>	<input checked="" type="checkbox"/>
		<input type="checkbox"/>	VT-Data	<input checked="" type="checkbox"/>	<input checked="" type="checkbox"/>

4 Service Types

Service type	Service name	Supported	Remarks
Alarm and Event Services	AcknowledgeAlarm	<input checked="" type="checkbox"/>	
	ConfirmedCOVNotification	<input type="checkbox"/>	
	ConfirmedEventNotification	<input type="checkbox"/>	
	GetAlarmSummary	<input checked="" type="checkbox"/>	
	GetEnrollmentSummary	<input type="checkbox"/>	
	SubscribeCOV	<input checked="" type="checkbox"/>	
File Access Services	AtomicReadFile	<input type="checkbox"/>	
	AtomicWriteFile	<input type="checkbox"/>	
Object Access Services	AddListElement	<input type="checkbox"/>	
	RemoveListElement	<input type="checkbox"/>	
	CreateObject	<input type="checkbox"/>	
	DeleteObject	<input type="checkbox"/>	
	ReadProperty	<input checked="" type="checkbox"/>	
	ReadPropertyConditional	<input type="checkbox"/>	
	ReadPropertyMultiple	<input checked="" type="checkbox"/>	
	ReadRange	<input checked="" type="checkbox"/>	
	WriteProperty	<input checked="" type="checkbox"/>	
	WritePropertyMultiple	<input checked="" type="checkbox"/>	
Remote Device Management Services	DeviceCommunicationControl	<input checked="" type="checkbox"/>	
	ConfirmedPrivateTransfer	<input type="checkbox"/>	
	ConfirmedTextMessage	<input type="checkbox"/>	
	ReinitializeDevice	<input checked="" type="checkbox"/>	
Virtual Terminal Services	VtOpen	<input type="checkbox"/>	
	VtClose	<input type="checkbox"/>	
	VtData	<input type="checkbox"/>	
Security Services	Authenticate	<input type="checkbox"/>	
	RequestKey	<input type="checkbox"/>	
Unconfirmed Services	I-Am	<input checked="" type="checkbox"/>	
	I-Have	<input type="checkbox"/>	
	UnconfirmedCOVNotification	<input type="checkbox"/>	
	UnconfirmedEventNotification	<input type="checkbox"/>	
	UnconfirmedPrivateTransfer	<input type="checkbox"/>	
	UnconfirmedTextMessage	<input type="checkbox"/>	
	TimeSynchronization	<input checked="" type="checkbox"/>	
	UtcTimeSynchronization	<input type="checkbox"/>	
	Who-Has	<input checked="" type="checkbox"/>	
	Who-Is	<input checked="" type="checkbox"/>	
	LifeSafetyOperation	<input type="checkbox"/>	
	SubscribeCOVProperty	<input type="checkbox"/>	
GetEventInformation	<input checked="" type="checkbox"/>		

5 Objects

5.1 Supported Object Types

The objects supported are shown in the table below.

Object Type	ID	Supported	Management Point
Analog-Input	0	<input checked="" type="checkbox"/>	OxxUxx_Setpoint_S OxxUxx_Room_Temperature OxxUxx_Disch.Setpoint Cool IU_S OxxUxx_Disch.Setpoint Cool AHU_S OxxUxx_Disch.Setpoint Heat IU_S OxxUxx_Disch.Setpoint Heat AHU_S OxxUxx_Disch. Current Temp. OxxUxx_Unit Error code OxxUxx_Error Slave Chiller Unit OxxUxx_Slave Chiller in Error OxxUxx_HotWater Setpoint HE_S OxxUxx_HotWater Setpoint HT_S OxxUxx_HotWater Setpoint EHS_S OxxUxx_HotWater Current Temp. OxxUxx_WaterIn Temperature OxxUxx_WaterOut Temperature, 31 OxxUxx_WaterOut Setpoint HE_S OxxUxx_WaterOut Setpoint HT_S OxxUxx_WaterOut Setpoint EHS_S OxxUxx_WaterOut Setpoint CHILL_S OxxUxx_WaterOut Average Temp.
Analog-Output	1	<input checked="" type="checkbox"/>	Temperature Setpoint (all units) OxxUxx_Setpoint_C OxxUxx_Disch.Setpoint Cool IU_C OxxUxx_Disch.Setpoint Cool AHU_C OxxUxx_Disch.Setpoint Heat IU_C OxxUxx_Disch.Setpoint Heat AHU_C OxxUxx_HotWater Setpoint HE_C OxxUxx_HotWater Setpoint HT_C OxxUxx_HotWater Setpoint EHS_C OxxUxx_WaterOut Setpoint HE_C OxxUxx_WaterOut Setpoint HT_C OxxUxx_WaterOut Setpoint EHS_C OxxUxx_WaterOut Setpoint CHILL_C
Analog-Value	2	<input type="checkbox"/>	
Averaging	18	<input type="checkbox"/>	
Binary-Input	3	<input checked="" type="checkbox"/>	OUxx_Communication Error OU OU Addressing Error OxxUxx_On/Off_S OxxUxx_Vane position swing_S OxxUxx_FilterSign OxxUxx_RC Restriction_S OxxUxx_HotWater On/Off_S OxxUxx_Vent. On/Off_S OXXUXX_WindFree_S OXXUXX_Air Clean_S
Binary-Output	4	<input checked="" type="checkbox"/>	On/Off (all units) Vane position swing (all units) Vent. On/Off (all units) Hot Water On/Off (all units) OxxUxx_On/Off_C OxxUxx_Vane position swing_C OxxUxx_FilterReset OxxUxx_RC Restriction_C OxxUxx_Buzzer Sound OxxUxx_HotWater On/Off_C OxxUxx_Vent. On/Off_C OXXUXX_WindFree_C

			OXXUXX_Air Clean_C
Binary-Value	5	<input type="checkbox"/>	
Calendar	6	<input type="checkbox"/>	
Command	7	<input type="checkbox"/>	
Device	8	<input checked="" type="checkbox"/>	Device INBACSAM--O000
Event-Enrollment	9	<input type="checkbox"/>	
File	10	<input type="checkbox"/>	
Group	11	<input type="checkbox"/>	
Life-Safety-Point	21	<input type="checkbox"/>	
Life-Safety-Zone	22	<input type="checkbox"/>	
Loop	12	<input type="checkbox"/>	
Multistate-Input	13	<input checked="" type="checkbox"/>	OxxUxx_Mode IU/AHU_S OxxUxx_Mode HE/EHS_S OxxUxx_Mode ERV+_S OxxUxx_Mode CHILLER_S OxxUxx_FanSpeed_S OxxUxx_Communication Status OxxUxx_Unit type OxxUxx_HotWater Mode HE/HT_S OxxUxx_HotWater Mode EHS_S OxxUxx_Vent. Mode_S OxxUxx_Vent. FanSpeed_S OXXUXX_360 CST Air Flow_S
Multistate-Output	14	<input checked="" type="checkbox"/>	Mode (all units) FanSpeed (all units) OxxUxx_Mode IU/AHU_C OxxUxx_Mode HE/EHS_C OxxUxx_Mode ERV+_C OxxUxx_Mode CHILLER_C OxxUxx_FanSpeed_C OxxUxx_HotWater Mode HE/HT_C OxxUxx_HotWater Mode EHS_C OxxUxx_Vent. Mode_C OxxUxx_Vent. FanSpeed_C OXXUXX_360 CST Air Flow_C
Multistate-Value	19	<input type="checkbox"/>	
Notification-Class	15	<input checked="" type="checkbox"/>	
Program	16	<input type="checkbox"/>	
Schedule	17	<input checked="" type="checkbox"/>	
Trend-Log	20	<input checked="" type="checkbox"/>	
Trend-Log-Multiple	27	<input checked="" type="checkbox"/>	

5.2 Member objects

5.2.1 Type: Gateway

Object-name	Description	Object-type	Object-instance
Device INBACSAM---O000	SAMSUNG to BACnet Gateway	Device	246
OU00_Communication Error OU		BI	0
OU01_Communication Error OU		BI	1
OU02_Communication Error OU		BI	2
OU03_Communication Error OU		BI	3
OU04_Communication Error OU		BI	4
OU05_Communication Error OU		BI	5
OU06_Communication Error OU		BI	6
OU07_Communication Error OU		BI	7
OU08_Communication Error OU		BI	8
OU09_Communication Error OU		BI	9
OU10_Communication Error OU		BI	10
OU11_Communication Error OU		BI	11
OU12_Communication Error OU		BI	12
OU13_Communication Error OU		BI	13
OU14_Communication Error OU		BI	14
OU15_Communication Error OU		BI	15
OU Addressing Error		BI	16

5.2.2 Type: Central control

Object-name	Description	Object-type	Object-instance
On/Off (all units)		BO	0
Mode (all units)		MO	0
FanSpeed (all units)		MO	1
Vane position swing (all units)		BO	1
Temperature Setpoint (all units)		AO	0
Vent. On/Off (all units)		BO	2
Hot Water On/Off (all units)		BO	3

5.2.3 Type: Indoor Unit

Object-name	Description	Object-type	Object-instance
OxxUxx_On/Off_S		BI	(xxx*100) + 0
OxxUxx_On/Off_C		BO	(xxx*100) + 0
OxxUxx_Mode IU/AHU_S		MI	(xxx*100) + 0
OxxUxx_Mode IU/AHU_C		MO	(xxx*100) + 0
OxxUxx_Setpoint_S		AI	(xxx*100) + 0
OxxUxx_Setpoint_C		AO	(xxx*100) + 0
OxxUxx_FanSpeed_S		MI	(xxx*100) + 1
OxxUxx_FanSpeed_C		MO	(xxx*100) + 1
OxxUxx_Vane position swing_S		BI	(xxx*100) + 1
OxxUxx_Vane position swing_C		BO	(xxx*100) + 1
OxxUxx_Room_Temperature		AI	(xxx*100) + 1
OxxUxx_Disch.Setpoint Cool IU_S		AI	(xxx*100) + 2
OxxUxx_Disch.Setpoint Cool IU_C		AO	(xxx*100) + 1

OxxUxx_Disch.Setpoint Heat IU_S		AI	(xxx*100) + 3
OxxUxx_Disch.Setpoint Heat IU_C		AO	(xxx*100) + 2
OxxUxx_Disch. Current Temp.		AI	(xxx*100) + 4
OxxUxx_Unit Error code		AI	(xxx*100) + 5
OxxUxx_FilterSign		BI	(xxx*100) + 2
OxxUxx_FilterReset		BO	(xxx*100) + 2
OxxUxx_Communication Status		MI	(xxx*100) + 2
OxxUxx_RC Restriction_S		BI	(xxx*100) + 3
OxxUxx_RC Restriction_C		BO	(xxx*100) + 3
OxxUxx_Buzzer Sound		BO	(xxx*100) + 4
OxxUxx_Unit type		MI	(xxx*100) + 3
OXXUXX_WindFree_S		BI	(xxx*100) + 6
OXXUXX_WindFree_C		BO	(xxx*100) + 7
OXXUXX_Air Clean_S		BI	(xxx*100) + 7
OXXUXX_Air Clean_C		BO	(xxx*100) + 8
OXXUXX_360 CST Air Flow_S		MI	(xxx*100) + 7
OXXUXX_360 CST Air Flow_C		MO	(xxx*100) + 5

5.2.4 Type: HE

Object-name	Description	Object-type	Object-instance
OxxUxx_On/Off_S		BI	(xxx*100) + 0
OxxUxx_On/Off_C		BO	(xxx*100) + 0
OxxUxx_Mode HE/EHS_S		MI	(xxx*100) + 0
OxxUxx_Mode HE/EHS_C		MO	(xxx*100) + 0
OxxUxx_Unit Error code		AI	(xxx*100) + 5
OxxUxx_Communication Status		MI	(xxx*100) + 2
OxxUxx_RC Restriction_S		BI	(xxx*100) + 3
OxxUxx_Unit type		MI	(xxx*100) + 3
OxxUxx_HotWater On/Off_S		BI	(xxx*100) + 4
OxxUxx_HotWater On/Off_C		BO	(xxx*100) + 5
OxxUxx_HotWater Mode HE/HT_S		MI	(xxx*100) + 4
OxxUxx_HotWater Mode HE/HT_C		MO	(xxx*100) + 2
OxxUxx_HotWater Setpoint HE_S		AI	(xxx*100) + 8
OxxUxx_HotWater Setpoint HE_C		AO	(xxx*100) + 3
OxxUxx_HotWater Current Temp.		AI	(xxx*100) + 9
OxxUxx_WaterIn Temperature		AI	(xxx*100) + 10
OxxUxx_WaterOut Temperature		AI	(xxx*100) + 11
OxxUxx_WaterOut Setpoint HE_S		AI	(xxx*100) + 12
OxxUxx_WaterOut Setpoint HE_C		AO	(xxx*100) + 4

5.2.5 Type: HT

Object-name	Description	Object-type	Object-instance
OxxUxx_On/Off_S		BI	(xxx*100) + 0
OxxUxx_On/Off_C		BO	(xxx*100) + 0
OxxUxx_Unit Error code		AI	(xxx*100) + 5
OxxUxx_Communication Status		MI	(xxx*100) + 2
OxxUxx_RC Restriction_S		BI	(xxx*100) + 3
OxxUxx_Unit type		MI	(xxx*100) + 3

OxxUxx_HotWater On/Off_S		BI	(xxx*100) + 4
OxxUxx_HotWater On/Off_C		BO	(xxx*100) + 5
OxxUxx_HotWater Mode HE/HT_S		MI	(xxx*100) + 4
OxxUxx_HotWater Mode HE/HT_C		MO	(xxx*100) + 2
OxxUxx_HotWater Setpoint HT_S		AI	(xxx*100) + 8
OxxUxx_HotWater Setpoint HT_C		AO	(xxx*100) + 3
OxxUxx_HotWater Current Temp.		AI	(xxx*100) + 9
OxxUxx_WaterIn Temperature		AI	(xxx*100) + 10
OxxUxx_WaterOut Temperature		AI	(xxx*100) + 11
OxxUxx_WaterOut Setpoint HT_S		AI	(xxx*100) + 12
OxxUxx_WaterOut Setpoint HT_C		AO	(xxx*100) + 4

5.2.6 Type: EHS

Object-name	Description	Object-type	Object-instance
OxxUxx_On/Off_S		BI	(xxx*100) + 0
OxxUxx_On/Off_C		BO	(xxx*100) + 0
OxxUxx_Mode HE/EHS_S		MI	(xxx*100) + 0
OxxUxx_Mode HE/EHS_C		MO	(xxx*100) + 0
OxxUxx_Unit Error code		AI	(xxx*100) + 5
OxxUxx_Communication Status		MI	(xxx*100) + 2
OxxUxx_RC Restriction_S		BI	(xxx*100) + 3
OxxUxx_Unit type		MI	(xxx*100) + 3
OxxUxx_HotWater On/Off_S		BI	(xxx*100) + 4
OxxUxx_HotWater On/Off_C		BO	(xxx*100) + 5
OxxUxx_HotWater Mode EHS_S		MI	(xxx*100) + 4
OxxUxx_HotWater Mode EHS_C		MO	(xxx*100) + 2
OxxUxx_HotWater Setpoint EHS_S		AI	(xxx*100) + 8
OxxUxx_HotWater Setpoint EHS_C		AO	(xxx*100) + 3
OxxUxx_HotWater Current Temp.		AI	(xxx*100) + 9
OxxUxx_WaterIn Temperature		AI	(xxx*100) + 10
OxxUxx_WaterOut Temperature		AI	(xxx*100) + 11
OxxUxx_WaterOut Setpoint EHS_S		AI	(xxx*100) + 12
OxxUxx_WaterOut Setpoint EHS_C		AO	(xxx*100) + 4

5.2.7 Type: AHU

Object-name	Description	Object-type	Object-instance
OxxUxx_On/Off_S		BI	(xxx*100) + 0
OxxUxx_On/Off_C		BO	(xxx*100) + 0
OxxUxx_Mode IU/AHU_S		MI	(xxx*100) + 0
OxxUxx_Mode IU/AHU_C		MO	(xxx*100) + 0
OxxUxx_Setpoint_S		AI	(xxx*100) + 0
OxxUxx_Setpoint_C		AO	(xxx*100) + 0
OxxUxx_Room_Temperature		AI	(xxx*100) + 1
OxxUxx_Disch.Setpoint Cool AHU_S		AI	(xxx*100) + 2
OxxUxx_Disch.Setpoint Cool AHU_C		AO	(xxx*100) + 1
OxxUxx_Disch.Setpoint Heat AHU_C		AI	(xxx*100) + 3
OxxUxx_Disch.Setpoint Heat AHU_C		AO	(xxx*100) + 2
OxxUxx_Disch. Current Temp.		AI	(xxx*100) + 4

OxxUxx_Unit Error code		AI	(xxx*100) + 5
OxxUxx_FilterSign		BI	(xxx*100) + 2
OxxUxx_Communication Status		MI	(xxx*100) + 2
OxxUxx_RC Restriction_S		BI	(xxx*100) + 3
OxxUxx_RC Restriction_C		BO	(xxx*100) + 3
OxxUxx_Unit type		MI	(xxx*100) + 3

5.2.8 Type: ERV

Object-name	Description	Object-type	Object-instance
OxxUxx_Unit Error code		AI	(xxx*100) + 5
OxxUxx_FilterSign		BI	(xxx*100) + 2
OxxUxx_FilterReset		BO	(xxx*100) + 2
OxxUxx_Communication Status		MI	(xxx*100) + 2
OxxUxx_RC Restriction_S		BI	(xxx*100) + 3
OxxUxx_RC Restriction_C		BO	(xxx*100) + 3
OxxUxx_Unit type		MI	(xxx*100) + 3
OxxUxx_Vent. On/Off_S		BI	(xxx*100) + 5
OxxUxx_Vent. On/Off_C		BO	(xxx*100) + 6
OxxUxx_Vent. Mode_S		MI	(xxx*100) + 5
OxxUxx_Vent. Mode_C		MO	(xxx*100) + 3
OxxUxx_Vent. FanSpeed_S		MI	(xxx*100) + 6
OxxUxx_Vent. FanSpeed_C		MO	(xxx*100) + 4

5.2.9 Type: ERV+

Object-name	Description	Object-type	Object-instance
OxxUxx_On/Off_S		BI	(xxx*100) + 0
OxxUxx_On/Off_C		BO	(xxx*100) + 0
OxxUxx_Mode ERV+_S		MI	(xxx*100) + 0
OxxUxx_Mode ERV+_C		MO	(xxx*100) + 0
OxxUxx_Unit Error code		AI	(xxx*100) + 5
OxxUxx_FilterSign		BI	(xxx*100) + 2
OxxUxx_FilterReset		BO	(xxx*100) + 2
OxxUxx_Communication Status		MI	(xxx*100) + 2
OxxUxx_RC Restriction_S		BI	(xxx*100) + 3
OxxUxx_RC Restriction_C		BO	(xxx*100) + 3
OxxUxx_Unit type		MI	(xxx*100) + 3
OxxUxx_Vent. On/Off_S		BI	(xxx*100) + 5
OxxUxx_Vent. On/Off_C		BO	(xxx*100) + 6
OxxUxx_Vent. Mode_S		MI	(xxx*100) + 5
OxxUxx_Vent. Mode_C		MO	(xxx*100) + 3
OxxUxx_Vent. FanSpeed_S		MI	(xxx*100) + 6
OxxUxx_Vent. FanSpeed_C		MO	(xxx*100) + 4

5.2.10 Type: CHILLER

Object-name	Description	Object-type	Object-instance
OxxUxx_On/Off_S		BI	(xxx*100) + 0
OxxUxx_On/Off_C		BO	(xxx*100) + 0

OxxUxx_Mode CHILLER_S		MI	(xxx*100) + 0
OxxUxx_Mode CHILLER_C		MO	(xxx*100) + 0
OxxUxx_Unit Error code		AI	(xxx*100) + 5
OxxUxx_Error Slave Chiller Unit		AI	(xxx*100) + 6
OxxUxx_Slave Chiller in Error		AI	(xxx*100) + 7
OxxUxx_Communication Status		MI	(xxx*100) + 2
OxxUxx_RC Restriction_S		BI	(xxx*100) + 3
OxxUxx_RC Restriction_C		BO	(xxx*100) + 3
OxxUxx_Unit type		MI	(xxx*100) + 3
OxxUxx_WaterOut Setpoint CHILL_S		AI	(xxx*100) + 12
OxxUxx_WaterOut Setpoint CHILL_C		AO	(xxx*100) + 4
OxxUxx_WaterOut Average Temp.		AI	(xxx*100) + 13

5.3 Objects and properties

Below you can find relevant information for the objects and properties.

Object_Identifier: In the **Device Object**, the value of object instance is configurable through LinkBoxBACnet. See Table 5.1 in order to obtain the name of each object.

Variable	Description
"Oxx"	Outdoor Unit address (0..15)
"Uxx"	Indoor Unit address (0..63)
"xxx"	Indoor Unit identifier (1..64)

Table 5.1 Objects and properties variables and descriptions

Object_Name: In the **Device Object**, this string is configurable through LinkBoxBACnet. See Table 5.1 in order to obtain the name of each object.

Description: In the **Device Object**, this string is configurable through LinkBoxBACnet. See Table 5.1 in order to obtain the description of each object.

Relinquish_Default: In **Binary Outputs**, **Multistate Outputs** and **Multistate Values**, the value of *Present_Value* property will be read.

Priority_Array: In **Binary Outputs**, **Multistate Outputs** and **Multistate Values**, *Priority_Array[16]* will acquire the value of *Present_Value* property and *Priority_Array[1]~[15]* will be NULL.

State_Text: In **Multistate Outputs**, **Multistate Outputs** and **Multistate Values**, it cannot be read the whole array at once, so "Array Index" must be specified in order to obtain the text of the corresponding state.

5.3.1 Device INBACSAM---O000 (Device Object Type)

Property Identifier	Property Datatype	Value	ASHRAE	IBOX
Object_Identifier	BACnetObjectIdentifier	(Device, 246)	R	R
Object_Name	CharacterString	"Device INBACSAM---O000"	R	R
Object_Type	BACnetObjectType	DEVICE (8) (Device Object Type)	R	R
System_Status	BACnetDeviceStatus	OPERATIONAL (0)	R	R
Vendor_Name	CharacterString	"HMS Industrial Networks S.L.U"	R	R
Vendor_Identifier	Unsigned16	246	R	R
Model_Name	CharacterString	"INBACSAM---O000"	R	R
Firmware_Revision	CharacterString	"12.1.0.3"	R	R
Application_Software_Version	CharacterString	"1.0.0.0"	R	R
Location	CharacterString	""	O	-
Description	CharacterString	"SAMSUNG to BACnet Gateway"	O	R
Protocol_Version	Unsigned	1	R	R
Protocol_Revision	Unsigned	12	R	R
Protocol_Services_Supported	BACnetServiceSupported	Refer to section 4 [Service Types]	R	R
Protocol_Object_Types_Supported	BACnetObjectTypes Supported	Refer to section Error! Reference source not found. [Object Types]	R	R
Object_List	BACnetArray[N] of BACnetObjectIdentifier	BACnetARRAY[N]	R	R
Structured_Object_List	BACnetArray[N] of BACnetObjectIdentifier	-	O	-
Max_APDU_Length_Accepted	Unsigned	480 when MSTP / 1476 when BACnet/IP	R	R
Segmentation_Supported	BACnetSegmentation	SEGMENTED-BOTH (0)	R	R
Max_Segments_accepted	Unsigned	16	O	R
VT_Classes_Supported	List of BACnetVTClass	-	O	-
Active_VT_Sessions	List of BACnetVTSession	-	O	-
Local_Date	Date	Current date	O	R
Local_Time	Time	Current time	O	R
UTC_Offset	INTEGER	-	O	-
Daylight_Savings_Status	BOOLEAN	-	O	-
APDU_Segment_Timeout	Unsigned	3000	R	R
APDU_Timeout	Unsigned	3000	R	R
Number_of_APDU_Retries	Unsigned	3	R	R
List_Of_Session_Keys	List of BACnetSessionKey	-	O	-
Time_Synchronization_Recipients	List of BACnetRecipient	-	O	-
Max_Master * **	Unsigned	127	R	W

Max_Info_Frames *	Unsigned	1	O	R
Device_Address_Binding	List of BACnetAddressBinding	NULL (empty)	R	R
Database_Revision	Unsigned	0	R	R
Configuration_Files	BACnetArray[N] of BACnetObjectIdentifier	-	O	-
Last_Restore_Time	BACnetTimeStamp	-	O	-
Backup_Failure_Timeout	Unsigned16	-	O	-
Active_COV_Subscriptions	List of BACnetCOVSubscription	List of BACnetCOVSubscription	O	R
Slave_Proxy_Enable	BACnetArray[N] of BOOLEAN	-	O	-
Manual_Slave_Address_Binding	List of BACnetAddressBinding	-	O	-
Auto_Slave_Discovery	BACnetArray[N] of BOOLEAN	-	O	-
Slave_Address_Binding	BACnetAddressBinding	-	O	-
Last_Restart_Reason	BACnetRestartReason	-	O	-
Time_Of_Device_Restart	BACnetTimeStamp	-	O	-
Restart_Notification_Recipients	List of BACnetRecipient	-	O	-
UTC_Time_Synchronization_Recipients	List of BACnetRecipient	-	O	-
Time_Synchronization_Interval	Unsigned	-	O	-
Align_Intervals	BOOLEAN	-	O	-
Interval_Offset	Unsigned	-	O	-
Profile_Name	CharacterString	-	O	-

* Only available when MSTP is used

** Configurable through the configuration tool.

5.3.2 OUxx_Communication Error OU (Binary Input Object Type)

Property Identifier	Property Datatype	Value	ASHRAE	IBOX
Object_Identifier	BACnetObjectIdentifier	(Binary Input, 0..15)	R	R
Object_Name	CharacterString	<i>OUxx_Communication Error OU</i>	R	R
Object_Type	BACnetObjectType	BINARY_INPUT (3)	R	R
Present_Value	BACnetBinaryPV	INACTIVE (0) / ACTIVE (1)	R	R
Description	CharacterString	-	O	-
Device_Type	CharacterString	-	O	-
Status_Flags	BACnetStatusFlags	{FALSE, FALSE/TRUE, FALSE, FALSE}	R	R
Event_State	BACnetEventState	STATE_NORMAL (0)	R	R
Reliability	BACnetReliability	NO_FAULT_DETECTED (0), UNRELIABLE_OTHER (7)	O	R
Out_Of_Service	BOOLEAN	FALSE	R	R
Polarity	BACnetPolarity	NORMAL (0)	R	R
Inactive_Text	CharacterString	<i>"No Error"</i>	O	R
Active_Text	CharacterString	<i>"Error"</i>	O	R
Change_Of_State_Time	BACnetDatetime	-	O	R
Change_Of_State_Count	Unsigned	-	O	R
Time_Of_State_Count_Reset	BACnetDatetime	-	O	R
Elapsed_Active_Time	Unsigned	-	O	R
Time_Of_Active_Time_Reset	BACnetDatetime	-	O	R
Time_Delay	Unsigned	-	O	R*
Notification_Class	Unsigned	-	O	R*
Alarm_Value	BACnetBinaryPV	-	O	R*
Event_Enable	BACnetEventTransitionBits	-	O	R*
Acked_Transitions	BACnetEventTransitionBits	-	O	R*
Notify_Type	BACnetNotifyType	-	O	R*
Event_Time_Stamps	BACnetArray[N] of BACnetTimeStamp	-	O	R*
Profile_Name	CharacterString	-	O	-

* Only available when specific object has a Notification Class configured

5.3.3 OU Addressing Error (Binary Input Object Type)

Property Identifier	Property Datatype	Value	ASHRAE	IBOX
Object_Identifier	BACnetObjectIdentifier	(Binary Input, 0..15)	R	R
Object_Name	CharacterString	<i>OU Addressing Error</i>	R	R
Object_Type	BACnetObjectType	BINARY_INPUT (3)	R	R
Present_Value	BACnetBinaryPV	INACTIVE (0) / ACTIVE (1)	R	R
Description	CharacterString	-	O	-
Device_Type	CharacterString	-	O	-
Status_Flags	BACnetStatusFlags	{FALSE, FALSE/TRUE, FALSE, FALSE}	R	R
Event_State	BACnetEventState	STATE_NORMAL (0)	R	R
Reliability	BACnetReliability	NO_FAULT_DETECTED (0), UNRELIABLE_OTHER (7)	O	R
Out_Of_Service	BOOLEAN	FALSE	R	R
Polarity	BACnetPolarity	NORMAL (0)	R	R
Inactive_Text	CharacterString	<i>"OU Addressing OK"</i>	O	R
Active_Text	CharacterString	<i>"Manual Addr in OU required"</i>	O	R
Change_Of_State_Time	BACnetDatetime	-	O	R
Change_Of_State_Count	Unsigned	-	O	R
Time_Of_State_Count_Reset	BACnetDatetime	-	O	R
Elapsed_Active_Time	Unsigned	-	O	R
Time_Of_Active_Time_Reset	BACnetDatetime	-	O	R
Time_Delay	Unsigned	-	O	R*
Notification_Class	Unsigned	-	O	R*
Alarm_Value	BACnetBinaryPV	-	O	R*
Event_Enable	BACnetEventTransitionBits	-	O	R*
Acked_Transitions	BACnetEventTransitionBits	-	O	R*
Notify_Type	BACnetNotifyType	-	O	R*
Event_Time_Stamps	BACnetArray[N] of BACnetTimeStamp	-	O	R*
Profile_Name	CharacterString	-	O	-

* Only available when specific object has a Notification Class configured

5.3.4 On/Off (all units) (Binary Output Object Type)

Property Identifier	Property Datatype	Value	ASHRAE	IBOX
Object_Identifier	BACnetObjectIdentifier	(Binary Output, 0)	R	R
Object_Name	CharacterString	<i>On/Off (all units)</i>	R	R
Object_Type	BACnetObjectType	BINARY_OUTPUT (4)	R	R
Present_Value	BACnetBinaryPV	INACTIVE (0) / ACTIVE (1)	W	W
Description	CharacterString	-	O	-
Device_Type	CharacterString	-	O	-
Status_Flags	BACnetStatusFlags	{FALSE, FALSE, FALSE, FALSE}	R	R
Event_State	BACnetEventState	STATE_NORMAL (0)	R	R
Reliability	BACnetReliability	NO_FAULT_DETECTED (0)	O	R
Out_Of_Service	BOOLEAN	FALSE	R	R
Polarity	BACnetPolarity	NORMAL (0)	R	R
Inactive_Text	CharacterString	<i>"Off"</i>	O	R
Active_Text	CharacterString	<i>"On"</i>	O	R
Change_Of_State_Time	BACnetDatetime	-	O	R
Change_Of_State_Count	Unsigned	-	O	R
Time_Of_State_Count_Reset	BACnetDatetime	-	O	R
Elapsed_Active_Time	Unsigned	-	O	R
Time_Of_Active_Time_Reset	BACnetDatetime	-	O	R
Minimum_Off_Time	Unsigned32	-	O	-
Minimum_On_Time	Unsigned32	-	O	-
Priority_Array	BACnetPriorityArray	BACnetPriorityArray	R	R
Relinquish_Default	BACnetBinaryPV	INACTIVE (0)	R	R
Time_Delay	Unsigned	-	O	R*
Notification_Class	Unsigned	-	O	R*
Feedback_Value	BACnetBinaryPV	-	O	W
Event_Enable	BACnetEventTransitionBits	-	O	R*
Acked_Transitions	BACnetEventTransitionBits	-	O	R*
Notify_Type	BACnetNotifyType	-	O	R*
Event_Time_Stamps	BACnetArray[N] of BACnetTimeStamp	-	O	R*
Profile_Name	CharacterString	-	O	-

* Only available when specific object has a Notification Class configured

5.3.5 Mode (all units) (Multistate Output Object Type)

Property Identifier	Property Datatype	Value	ASHRAE	IBOX
Object_Identifier	BACnetObjectIdentifier	(Multi-state Output, 0)	R	R
Object_Name	CharacterString	<i>Mode (all units)</i>	R	R
Object_Type	BACnetObjectType	MULTISTATE_OUTPUT (14)	R	R
Present_Value	Unsigned	x	W	W
Description	CharacterString	-	O	-
Device_Type	CharacterString	-	O	-
Status_Flags	BACnetStatusFlags	{FALSE, FALSE, FALSE, FALSE}	R	R
Event_State	BACnetEventState	STATE_NORMAL (0)	R	R
Reliability	BACnetReliability	NO_FAULT_DETECTED (0)	O	R
Out_Of_Service	BOOLEAN	FALSE	R	R
Number_Of_States	Unsigned	7	R	R
State_Text	BACnetArray[N] of CharacterString	<i>Check Mode (all units) table below</i>	O	R
Priority_Array	BACnetPriorityArray	BACnetPriorityArray	R	R
Relinquish_Default	Unsigned	1	R	R
Time_Delay	Unsigned	-	O	R*
Notification_Class	Unsigned	-	O	R*
Feedback_Value	Unsigned	-	O	W
Event_Enable	BACnetEventTransitionBits	-	O	R*
Acked_Transitions	BACnetEventTransitionBits	-	O	R*
Notify_Type	BACnetNotifyType	-	O	R*
Event_Time_Stamps	BACnetArray[N] of BACnetTimeStamp	-	O	R*
Profile_Name	CharacterString	-	O	-

* Only available when specific object has a Notification Class configured

Mode (all units) table (see next page)

Mode (all units) table

Mode interpretation is possible using the value in the following correspondence table.

Pesent_Value	Contents displayed in State_Text
1	Heat
2	Dry
3	Fan
4	Cool
5	Auto
6	Cool Storage
7	Hot Water

5.3.6 FanSpeed (all units) (Multistate Input Object Type)

Property Identifier	Property Datatype	Value	ASHRAE	IBOX
Object_Identifier	BACnetObjectIdentifier	(Multi-state Output, 1)	R	R
Object_Name	CharacterString	<i>FanSpeed (all units)</i>	R	R
Object_Type	BACnetObjectType	MULTISTATE_OUTPUT (14)	R	R
Present_Value	Unsigned	x	W	W
Description	CharacterString	-	O	-
Device_Type	CharacterString	-	O	-
Status_Flags	BACnetStatusFlags	{FALSE, FALSE, FALSE, FALSE}	R	R
Event_State	BACnetEventState	STATE_NORMAL (0)	R	R
Reliability	BACnetReliability	NO_FAULT_DETECTED (0)	O	R
Out_Of_Service	BOOLEAN	FALSE	R	R
Number_Of_States	Unsigned	4	R	R
State_Text	BACnetArray[N] of CharacterString	<i>Check FanSpeed (all units) table below</i>	O	R
Priority_Array	BACnetPriorityArray	BACnetPriorityArray	R	R
Relinquish_Default	Unsigned	1	R	R
Time_Delay	Unsigned	-	O	R*
Notification_Class	Unsigned	-	O	R*
Feedback_Value	Unsigned	-	O	W
Event_Enable	BACnetEventTransitionBits	-	O	R*
Acked_Transitions	BACnetEventTransitionBits	-	O	R*
Notify_Type	BACnetNotifyType	-	O	R*
Event_Time_Stamps	BACnetArray[N] of BACnetTimeStamp	-	O	R*
Profile_Name	CharacterString	-	O	-

* Only available when specific object has a Notification Class configured

FanSpeed (all units) table

FanSpeed interpretation is possible using the value in the following correspondence table.

Present_Value	Contents displayed in State_Text
1	Low
2	Mid
3	High
4	Auto

5.3.7 Vane position swing (all units) (Binary Output Object Type)

Property Identifier	Property Datatype	Value	ASHRAE	IBOX
Object_Identifier	BACnetObjectIdentifier	(Binary Output, 0)	R	R
Object_Name	CharacterString	<i>Vane position swing (all units)</i>	R	R
Object_Type	BACnetObjectType	BINARY_OUTPUT (4)	R	R
Present_Value	BACnetBinaryPV	INACTIVE (0) / ACTIVE (1)	W	W
Description	CharacterString	-	O	-
Device_Type	CharacterString	-	O	-
Status_Flags	BACnetStatusFlags	{FALSE, FALSE, FALSE, FALSE}	R	R
Event_State	BACnetEventState	STATE_NORMAL (0)	R	R
Reliability	BACnetReliability	NO_FAULT_DETECTED (0)	O	R
Out_Of_Service	BOOLEAN	FALSE	R	R
Polarity	BACnetPolarity	NORMAL (0)	R	R
Inactive_Text	CharacterString	<i>"Swing Off"</i>	O	R
Active_Text	CharacterString	<i>"Swing On"</i>	O	R
Change_Of_State_Time	BACnetDatetime	-	O	R
Change_Of_State_Count	Unsigned	-	O	R
Time_Of_State_Count_Reset	BACnetDatetime	-	O	R
Elapsed_Active_Time	Unsigned	-	O	R
Time_Of_Active_Time_Reset	BACnetDatetime	-	O	R
Minimum_Off_Time	Unsigned32	-	O	-
Minimum_On_Time	Unsigned32	-	O	-
Priority_Array	BACnetPriorityArray	BACnetPriorityArray	R	R
Relinquish_Default	BACnetBinaryPV	INACTIVE (0)	R	R
Time_Delay	Unsigned	-	O	R*
Notification_Class	Unsigned	-	O	R*
Feedback_Value	BACnetBinaryPV	-	O	W
Event_Enable	BACnetEventTransitionBits	-	O	R*
Acked_Transitions	BACnetEventTransitionBits	-	O	R*
Notify_Type	BACnetNotifyType	-	O	R*
Event_Time_Stamps	BACnetArray[N] of BACnetTimeStamp	-	O	R*
Profile_Name	CharacterString	-	O	-

* Only available when specific object has a Notification Class configured

5.3.8 Temperature Setpoint (all units) (Analog Output Object Type)

Property Identifier	Property Datatype	Value	ASHRAE	IBOX
Object_Identifier	BACnetObjectIdentifier	(Analog Output, 0)	R	R
Object_Name	CharacterString	<i>Temperature Setpoint (all units)</i>	R	R
Object_Type	BACnetObjectType	ANALOG_OUTPUT (1)	R	R
Present_Value	REAL	x	W	W
Description	CharacterString	-	O	-
Device_Type	CharacterString	-	O	-
Status_Flags	BACnetStatusFlags	{FALSE, FALSE, FALSE, FALSE}	R	R
Event_State	BACnetEventState	STATE_NORMAL (0)	R	R
Reliability	BACnetReliability	NO_FAULT_DETECTED (0)	O	R
Out_Of_Service	BOOLEAN	FALSE	R	R
Update_Interval	Unsigned	-	O	-
Units	BACnetEngineeringUnits	<i>degrees_Celsius</i>	R	R
Min_Pres_Value	REAL	-	O	-
Max_Pres_Value	REAL	-	O	-
Resolution	REAL	-	O	-
COV_Increment	REAL	0	O	R
Priority_Array	BACnetPriorityArray	BACnetPriorityArray	R	R
Relinquish_Default	Unsigned	<i>Configurable through BACnet and Config Tool</i>	R	R
Time_Delay	Unsigned	-	O	R*
Notification_Class	Unsigned	-	O	R*
High_Limit	REAL	-	O	R*
Low_Limit	REAL	-	O	R*
Deadband	REAL	-	O	R*
Limit_Enable	BACnetLimitEnable	-	O	R*
Event_Enable	BACnetEventTransitionBits	-	O	R*
Acked_Transitions	BACnetEventTransitionBits	-	O	R*
Notify_Type	BACnetNotifyType	-	O	R*
Event_Time_Stamps	BACnetArray[N] of BACnetTimeStamp	-	O	R*
Profile_Name	CharacterString	-	O	-

* Only available when specific object has a Notification Class configured

5.3.9 Vent. On/Off (all units) (Binary Output Object Type)

Property Identifier	Property Datatype	Value	ASHRAE	IBOX
Object_Identifier	BACnetObjectIdentifier	(Binary Output, 0)	R	R
Object_Name	CharacterString	<i>Vent. On/Off (all units)</i>	R	R
Object_Type	BACnetObjectType	BINARY_OUTPUT (4)	R	R
Present_Value	BACnetBinaryPV	INACTIVE (0) / ACTIVE (1)	W	W
Description	CharacterString	-	O	-
Device_Type	CharacterString	-	O	-
Status_Flags	BACnetStatusFlags	{FALSE, FALSE, FALSE, FALSE}	R	R
Event_State	BACnetEventState	STATE_NORMAL (0)	R	R
Reliability	BACnetReliability	NO_FAULT_DETECTED (0)	O	R
Out_Of_Service	BOOLEAN	FALSE	R	R
Polarity	BACnetPolarity	NORMAL (0)	R	R
Inactive_Text	CharacterString	<i>"Off"</i>	O	R
Active_Text	CharacterString	<i>"On"</i>	O	R
Change_Of_State_Time	BACnetDatetime	-	O	R
Change_Of_State_Count	Unsigned	-	O	R
Time_Of_State_Count_Reset	BACnetDatetime	-	O	R
Elapsed_Active_Time	Unsigned	-	O	R
Time_Of_Active_Time_Reset	BACnetDatetime	-	O	R
Minimum_Off_Time	Unsigned32	-	O	-
Minimum_On_Time	Unsigned32	-	O	-
Priority_Array	BACnetPriorityArray	BACnetPriorityArray	R	R
Relinquish_Default	BACnetBinaryPV	INACTIVE (0)	R	R
Time_Delay	Unsigned	-	O	R*
Notification_Class	Unsigned	-	O	R*
Feedback_Value	BACnetBinaryPV	-	O	W
Event_Enable	BACnetEventTransitionBits	-	O	R*
Acked_Transitions	BACnetEventTransitionBits	-	O	R*
Notify_Type	BACnetNotifyType	-	O	R*
Event_Time_Stamps	BACnetArray[N] of BACnetTimeStamp	-	O	R*
Profile_Name	CharacterString	-	O	-

* Only available when specific object has a Notification Class configured

5.3.10 Hot Water On/Off (all units) (Binary Output Object Type)

Property Identifier	Property Datatype	Value	ASHRAE	IBOX
Object_Identifier	BACnetObjectIdentifier	(Binary Output, 0)	R	R
Object_Name	CharacterString	<i>Hot Water On/Off (all units)</i>	R	R
Object_Type	BACnetObjectType	BINARY_OUTPUT (4)	R	R
Present_Value	BACnetBinaryPV	INACTIVE (0) / ACTIVE (1)	W	W
Description	CharacterString	-	O	-
Device_Type	CharacterString	-	O	-
Status_Flags	BACnetStatusFlags	{FALSE, FALSE, FALSE, FALSE}	R	R
Event_State	BACnetEventState	STATE_NORMAL (0)	R	R
Reliability	BACnetReliability	NO_FAULT_DETECTED (0)	O	R
Out_Of_Service	BOOLEAN	FALSE	R	R
Polarity	BACnetPolarity	NORMAL (0)	R	R
Inactive_Text	CharacterString	"Off"	O	R
Active_Text	CharacterString	"On"	O	R
Change_Of_State_Time	BACnetDatetime	-	O	R
Change_Of_State_Count	Unsigned	-	O	R
Time_Of_State_Count_Reset	BACnetDatetime	-	O	R
Elapsed_Active_Time	Unsigned	-	O	R
Time_Of_Active_Time_Reset	BACnetDatetime	-	O	R
Minimum_Off_Time	Unsigned32	-	O	-
Minimum_On_Time	Unsigned32	-	O	-
Priority_Array	BACnetPriorityArray	BACnetPriorityArray	R	R
Relinquish_Default	BACnetBinaryPV	INACTIVE (0)	R	R
Time_Delay	Unsigned	-	O	R*
Notification_Class	Unsigned	-	O	R*
Feedback_Value	BACnetBinaryPV	-	O	W
Event_Enable	BACnetEventTransitionBits	-	O	R*
Acked_Transitions	BACnetEventTransitionBits	-	O	R*
Notify_Type	BACnetNotifyType	-	O	R*
Event_Time_Stamps	BACnetArray[N] of BACnetTimeStamp	-	O	R*
Profile_Name	CharacterString	-	O	-

* Only available when specific object has a Notification Class configured

5.3.11 OxxUxx_On/Off_S (Binary Input Object Type)

Property Identifier	Property Datatype	Value	ASHRAE	IBOX
Object_Identifier	BACnetObjectIdentifier	(Binary Input, (xxx*100) + 0)	R	R
Object_Name	CharacterString	<i>OxxUxx_On/Off_S</i>	R	R
Object_Type	BACnetObjectType	BINARY_INPUT (3)	R	R
Present_Value	BACnetBinaryPV	INACTIVE (0) / ACTIVE (1)	R	R
Description	CharacterString	-	O	-
Device_Type	CharacterString	-	O	-
Status_Flags	BACnetStatusFlags	{FALSE, FALSE/TRUE, FALSE, FALSE}	R	R
Event_State	BACnetEventState	STATE_NORMAL (0)	R	R
Reliability	BACnetReliability	NO_FAULT_DETECTED (0), UNRELIABLE_OTHER (7)	O	R
Out_Of_Service	BOOLEAN	FALSE	R	R
Polarity	BACnetPolarity	NORMAL (0)	R	R
Inactive_Text	CharacterString	"Off"	O	R
Active_Text	CharacterString	"On"	O	R
Change_Of_State_Time	BACnetDatetime	-	O	R
Change_Of_State_Count	Unsigned	-	O	R
Time_Of_State_Count_Reset	BACnetDatetime	-	O	R
Elapsed_Active_Time	Unsigned	-	O	R
Time_Of_Active_Time_Reset	BACnetDatetime	-	O	R
Time_Delay	Unsigned	-	O	R*
Notification_Class	Unsigned	-	O	R*
Alarm_Value	BACnetBinaryPV	-	O	R*
Event_Enable	BACnetEventTransitionBits	-	O	R*
Acked_Transitions	BACnetEventTransitionBits	-	O	R*
Notify_Type	BACnetNotifyType	-	O	R*
Event_Time_Stamps	BACnetArray[N] of BACnetTimeStamp	-	O	R*
Profile_Name	CharacterString	-	O	-

* Only available when specific object has a Notification Class configured

5.3.12 OxxUxx_On/Off_C (Binary Output Object Type)

Property Identifier	Property Datatype	Value	ASHRAE	IBOX
Object_Identifier	BACnetObjectIdentifier	(Binary Output, (xxx*100) + 0)	R	R
Object_Name	CharacterString	<i>OxxUxx_On/Off_C</i>	R	R
Object_Type	BACnetObjectType	BINARY_OUTPUT (4)	R	R
Present_Value	BACnetBinaryPV	INACTIVE (0) / ACTIVE (1)	W	W
Description	CharacterString	-	O	-
Device_Type	CharacterString	-	O	-
Status_Flags	BACnetStatusFlags	{FALSE, FALSE, FALSE, FALSE}	R	R
Event_State	BACnetEventState	STATE_NORMAL (0)	R	R
Reliability	BACnetReliability	NO_FAULT_DETECTED (0)	O	R
Out_Of_Service	BOOLEAN	FALSE	R	R
Polarity	BACnetPolarity	NORMAL (0)	R	R
Inactive_Text	CharacterString	<i>"Off"</i>	O	R
Active_Text	CharacterString	<i>"On"</i>	O	R
Change_Of_State_Time	BACnetDatetime	-	O	R
Change_Of_State_Count	Unsigned	-	O	R
Time_Of_State_Count_Reset	BACnetDatetime	-	O	R
Elapsed_Active_Time	Unsigned	-	O	R
Time_Of_Active_Time_Reset	BACnetDatetime	-	O	R
Minimum_Off_Time	Unsigned32	-	O	-
Minimum_On_Time	Unsigned32	-	O	-
Priority_Array	BACnetPriorityArray	BACnetPriorityArray	R	R
Relinquish_Default	BACnetBinaryPV	INACTIVE (0)	R	R
Time_Delay	Unsigned	-	O	R*
Notification_Class	Unsigned	-	O	R*
Feedback_Value	BACnetBinaryPV	-	O	W
Event_Enable	BACnetEventTransitionBits	-	O	R*
Acked_Transitions	BACnetEventTransitionBits	-	O	R*
Notify_Type	BACnetNotifyType	-	O	R*
Event_Time_Stamps	BACnetArray[N] of BACnetTimeStamp	-	O	R*
Profile_Name	CharacterString	-	O	-

* Only available when specific object has a Notification Class configured

5.3.13 OxxUxx_Mode IU/AHU_S (Multistate Input Object Type)

Property Identifier	Property Datatype	Value	ASHRAE	IBOX
Object_Identifier	BACnetObjectIdentifier	(Multi-state Input, (xxx*100) + 0)	R	R
Object_Name	CharacterString	<i>OxxUxx_Mode IU/AHU_S</i>	R	R
Object_Type	BACnetObjectType	MULTISTATE_INPUT (13)	R	R
Present_Value	Unsigned	x	R	R
Description	CharacterString	-	O	-
Device_Type	CharacterString	-	O	-
Status_Flags	BACnetStatusFlags	{FALSE, FALSE/TRUE, FALSE, FALSE}	R	R
Event_State	BACnetEventState	STATE_NORMAL (0)	R	R
Reliability	BACnetReliability	NO_FAULT_DETECTED (0), UNRELIABLE_OTHER (7)	O	R
Out_Of_Service	BOOLEAN	FALSE	R	R
Number_Of_States	Unsigned	7	R	R
State_Text	BACnetArray[N] of CharacterString	<i>Check Mode IU/AHU table below</i>	O	R
Time_Delay	Unsigned	-	O	R*
Notification_Class	Unsigned	-	O	R*
Alarm_Values	List of Unsigned	-	O	R*
Fault_Values	List of Unsigned	-	O	R*
Event_Enable	BACnetEventTransitionBits	-	O	R*
Acked_Transitions	BACnetEventTransitionBits	-	O	R*
Notify_Type	BACnetNotifyType	-	O	R*
Event_Time_Stamps	BACnetArray[N] of BACnetTimeStamp	-	O	R*
Profile_Name	CharacterString	-	O	-

* Only available when specific object has a Notification Class configured

Mode IU/AHU table

Mode IU/AHU interpretation is possible using the value in the following correspondence table.

Present_Value	Contents displayed in State_Text
1	Heat
2	Dry
3	Fan
4	Cool
5	Auto
6	Not Valid
7	Not Valid

5.3.14 OxxUxx_Mode HE/EHS_S (Multistate Input Object Type)

Property Identifier	Property Datatype	Value	ASHRAE	IBOX
Object_Identifier	BACnetObjectIdentifier	(Multi-state Input, (xxx*100) + 0)	R	R
Object_Name	CharacterString	<i>OxxUxx_Mode HE/EHS_S</i>	R	R
Object_Type	BACnetObjectType	MULTISTATE_INPUT (13)	R	R
Present_Value	Unsigned	x	R	R
Description	CharacterString	-	O	-
Device_Type	CharacterString	-	O	-
Status_Flags	BACnetStatusFlags	{FALSE, FALSE/TRUE, FALSE, FALSE}	R	R
Event_State	BACnetEventState	STATE_NORMAL (0)	R	R
Reliability	BACnetReliability	NO_FAULT_DETECTED (0), UNRELIABLE_OTHER (7)	O	R
Out_Of_Service	BOOLEAN	FALSE	R	R
Number_Of_States	Unsigned	7	R	R
State_Text	BACnetArray[N] of CharacterString	<i>Check Mode HE/EHS table below</i>	O	R
Time_Delay	Unsigned	-	O	R*
Notification_Class	Unsigned	-	O	R*
Alarm_Values	List of Unsigned	-	O	R*
Fault_Values	List of Unsigned	-	O	R*
Event_Enable	BACnetEventTransitionBits	-	O	R*
Acked_Transitions	BACnetEventTransitionBits	-	O	R*
Notify_Type	BACnetNotifyType	-	O	R*
Event_Time_Stamps	BACnetArray[N] of BACnetTimeStamp	-	O	R*
Profile_Name	CharacterString	-	O	-

* Only available when specific object has a Notification Class configured

Mode HE/EHS table

Mode HE/EHS interpretation is possible using the value in the following correspondence table.

Present_Value	Contents displayed in State_Text
1	Heat
2	Not Valid
3	Not Valid
4	Cool
5	Not Valid
6	Not Valid
7	Not Valid

5.3.15 OxxUxx_Mode ERV+_S (Multistate Input Object Type)

Property Identifier	Property Datatype	Value	ASHRAE	IBOX
Object_Identifier	BACnetObjectIdentifier	(Multi-state Input, (xxx*100) + 0)	R	R
Object_Name	CharacterString	<i>OxxUxx_Mode ERV+_S</i>	R	R
Object_Type	BACnetObjectType	MULTISTATE_INPUT (13)	R	R
Present_Value	Unsigned	x	R	R
Description	CharacterString	-	O	-
Device_Type	CharacterString	-	O	-
Status_Flags	BACnetStatusFlags	{FALSE, FALSE/TRUE, FALSE, FALSE}	R	R
Event_State	BACnetEventState	STATE_NORMAL (0)	R	R
Reliability	BACnetReliability	NO_FAULT_DETECTED (0), UNRELIABLE_OTHER (7)	O	R
Out_Of_Service	BOOLEAN	FALSE	R	R
Number_Of_States	Unsigned	7	R	R
State_Text	BACnetArray[N] of CharacterString	<i>Check Mode ERV+ table below</i>	O	R
Time_Delay	Unsigned	-	O	R*
Notification_Class	Unsigned	-	O	R*
Alarm_Values	List of Unsigned	-	O	R*
Fault_Values	List of Unsigned	-	O	R*
Event_Enable	BACnetEventTransitionBits	-	O	R*
Acked_Transitions	BACnetEventTransitionBits	-	O	R*
Notify_Type	BACnetNotifyType	-	O	R*
Event_Time_Stamps	BACnetArray[N] of BACnetTimeStamp	-	O	R*
Profile_Name	CharacterString	-	O	-

* Only available when specific object has a Notification Class configured

Mode ERV+ table

Mode ERV+ interpretation is possible using the value in the following correspondence table.

Present_Value	Contents displayed in State_Text
1	Heat
2	Not Valid
3	Not Valid
4	Cool
5	Auto
6	Not Valid
7	Not Valid

5.3.16 OxxUxx_Mode CHILLER_S (Multistate Input Object Type)

Property Identifier	Property Datatype	Value	ASHRAE	IBOX
Object_Identifier	BACnetObjectIdentifier	(Multi-state Input, (xxx*100) + 0)	R	R
Object_Name	CharacterString	<i>OxxUxx_Mode CHILLER_S</i>	R	R
Object_Type	BACnetObjectType	MULTISTATE_INPUT (13)	R	R
Present_Value	Unsigned	x	R	R
Description	CharacterString	-	O	-
Device_Type	CharacterString	-	O	-
Status_Flags	BACnetStatusFlags	{FALSE, FALSE/TRUE, FALSE, FALSE}	R	R
Event_State	BACnetEventState	STATE_NORMAL (0)	R	R
Reliability	BACnetReliability	NO_FAULT_DETECTED (0), UNRELIABLE_OTHER (7)	O	R
Out_Of_Service	BOOLEAN	FALSE	R	R
Number_Of_States	Unsigned	7	R	R
State_Text	BACnetArray[N] of CharacterString	<i>Check Mode CHILLER table below</i>	O	R
Time_Delay	Unsigned	-	O	R*
Notification_Class	Unsigned	-	O	R*
Alarm_Values	List of Unsigned	-	O	R*
Fault_Values	List of Unsigned	-	O	R*
Event_Enable	BACnetEventTransitionBits	-	O	R*
Acked_Transitions	BACnetEventTransitionBits	-	O	R*
Notify_Type	BACnetNotifyType	-	O	R*
Event_Time_Stamps	BACnetArray[N] of BACnetTimeStamp	-	O	R*
Profile_Name	CharacterString	-	O	-

* Only available when specific object has a Notification Class configured

Mode CHILLER table

Mode Chiller interpretation is possible using the value in the following correspondence table.

Present_Value	Contents displayed in State_Text
1	Heat
2	Not Valid
3	Not Valid
4	Cool
5	Not Valid
6	Cool Storage
7	Heat Storage

5.3.17 OxxUxx_Mode IU/AHU_C (Multistate Output Object Type)

Property Identifier	Property Datatype	Value	ASHRAE	IBOX
Object_Identifier	BACnetObjectIdentifier	(Multi-state Output, (xxx*100) + 0)	R	R
Object_Name	CharacterString	<i>OxxUxx_Mode IU/AHU_C</i>	R	R
Object_Type	BACnetObjectType	MULTISTATE_OUTPUT (14)	R	R
Present_Value	Unsigned	x	W	W
Description	CharacterString	-	O	-
Device_Type	CharacterString	-	O	-
Status_Flags	BACnetStatusFlags	{FALSE, FALSE, FALSE, FALSE}	R	R
Event_State	BACnetEventState	STATE_NORMAL (0)	R	R
Reliability	BACnetReliability	NO_FAULT_DETECTED (0)	O	R
Out_Of_Service	BOOLEAN	FALSE	R	R
Number_Of_States	Unsigned	7	R	R
State_Text	BACnetArray[N] of CharacterString	<i>Check Mode IU/AHU table below</i>	O	R
Priority_Array	BACnetPriorityArray	BACnetPriorityArray	R	R
Relinquish_Default	Unsigned	1	R	R
Time_Delay	Unsigned	-	O	R*
Notification_Class	Unsigned	-	O	R*
Feedback_Value	Unsigned	-	O	W
Event_Enable	BACnetEventTransitionBits	-	O	R*
Acked_Transitions	BACnetEventTransitionBits	-	O	R*
Notify_Type	BACnetNotifyType	-	O	R*
Event_Time_Stamps	BACnetArray[N] of BACnetTimeStamp	-	O	R*
Profile_Name	CharacterString	-	O	-

* Only available when specific object has a Notification Class configured

Mode IU/AHU table (see next page)

Mode IU/AHU table

Mode IU/AHU interpretation is possible using the value in the following correspondence table.

Pesent_Value	Contents displayed in State_Text
1	Heat
2	Dry
3	Fan
4	Cool
5	Auto
6	Not Valid
7	Not Valid

5.3.18 OxxUxx_Mode HE/EHS_C (Multistate Output Object Type)

Property Identifier	Property Datatype	Value	ASHRAE	IBOX
Object_Identifier	BACnetObjectIdentifier	(Multi-state Output, (xxx*100) + 0)	R	R
Object_Name	CharacterString	<i>OxxUxx_Mode HE/EHS_C</i>	R	R
Object_Type	BACnetObjectType	MULTISTATE_OUTPUT (14)	R	R
Present_Value	Unsigned	x	W	W
Description	CharacterString	-	O	-
Device_Type	CharacterString	-	O	-
Status_Flags	BACnetStatusFlags	{FALSE, FALSE, FALSE, FALSE}	R	R
Event_State	BACnetEventState	STATE_NORMAL (0)	R	R
Reliability	BACnetReliability	NO_FAULT_DETECTED (0)	O	R
Out_Of_Service	BOOLEAN	FALSE	R	R
Number_Of_States	Unsigned	7	R	R
State_Text	BACnetArray[N] of CharacterString	<i>Check Mode HE/EHS table below</i>	O	R
Priority_Array	BACnetPriorityArray	BACnetPriorityArray	R	R
Relinquish_Default	Unsigned	1	R	R
Time_Delay	Unsigned	-	O	R*
Notification_Class	Unsigned	-	O	R*
Feedback_Value	Unsigned	-	O	W
Event_Enable	BACnetEventTransitionBits	-	O	R*
Acked_Transitions	BACnetEventTransitionBits	-	O	R*
Notify_Type	BACnetNotifyType	-	O	R*
Event_Time_Stamps	BACnetArray[N] of BACnetTimeStamp	-	O	R*
Profile_Name	CharacterString	-	O	-

* Only available when specific object has a Notification Class configured

Mode HE/EHS table (see next page)

Mode HE/EHS table

Mode HE/EHS interpretation is possible using the value in the following correspondence table.

Pesent_Value	Contents displayed in State_Text
1	Heat
2	Not Valid
3	Not Valid
4	Cool
5	Not Valid
6	Not Valid
7	Not Valid

5.3.19 OxxUxx_Mode ERV+_C (Multistate Output Object Type)

Property Identifier	Property Datatype	Value	ASHRAE	IBOX
Object_Identifier	BACnetObjectIdentifier	(Multi-state Output, (xxx*100) + 0)	R	R
Object_Name	CharacterString	<i>OxxUxx_Mode ERV+_C</i>	R	R
Object_Type	BACnetObjectType	MULTISTATE_OUTPUT (14)	R	R
Present_Value	Unsigned	x	W	W
Description	CharacterString	-	O	-
Device_Type	CharacterString	-	O	-
Status_Flags	BACnetStatusFlags	{FALSE, FALSE, FALSE, FALSE}	R	R
Event_State	BACnetEventState	STATE_NORMAL (0)	R	R
Reliability	BACnetReliability	NO_FAULT_DETECTED (0)	O	R
Out_Of_Service	BOOLEAN	FALSE	R	R
Number_Of_States	Unsigned	7	R	R
State_Text	BACnetArray[N] of CharacterString	<i>Check Mode ERV+ table below</i>	O	R
Priority_Array	BACnetPriorityArray	BACnetPriorityArray	R	R
Relinquish_Default	Unsigned	1	R	R
Time_Delay	Unsigned	-	O	R*
Notification_Class	Unsigned	-	O	R*
Feedback_Value	Unsigned	-	O	W
Event_Enable	BACnetEventTransitionBits	-	O	R*
Acked_Transitions	BACnetEventTransitionBits	-	O	R*
Notify_Type	BACnetNotifyType	-	O	R*
Event_Time_Stamps	BACnetArray[N] of BACnetTimeStamp	-	O	R*
Profile_Name	CharacterString	-	O	-

* Only available when specific object has a Notification Class configured

Mode ERV+ table (see next page)

Mode ERV+ table

Mode ERV+ interpretation is possible using the value in the following correspondence table.

Pesent_Value	Contents displayed in State_Text
1	Heat
2	Not Valid
3	Not Valid
4	Cool
5	Auto
6	Not Valid
7	Not Valid

5.3.20 OxxUxx_Mode CHILLER_C (Multistate Input Object Type)

Property Identifier	Property Datatype	Value	ASHRAE	IBOX
Object_Identifier	BACnetObjectIdentifier	(Multi-state Output, (xxx*100) + 0)	R	R
Object_Name	CharacterString	<i>OxxUxx_Mode CHILLER_C</i>	R	R
Object_Type	BACnetObjectType	MULTISTATE_OUTPUT (14)	R	R
Present_Value	Unsigned	x	W	W
Description	CharacterString	-	O	-
Device_Type	CharacterString	-	O	-
Status_Flags	BACnetStatusFlags	{FALSE, FALSE, FALSE, FALSE}	R	R
Event_State	BACnetEventState	STATE_NORMAL (0)	R	R
Reliability	BACnetReliability	NO_FAULT_DETECTED (0)	O	R
Out_Of_Service	BOOLEAN	FALSE	R	R
Number_Of_States	Unsigned	7	R	R
State_Text	BACnetArray[N] of CharacterString	<i>Check Mode CHILLER table below</i>	O	R
Priority_Array	BACnetPriorityArray	BACnetPriorityArray	R	R
Relinquish_Default	Unsigned	1	R	R
Time_Delay	Unsigned	-	O	R*
Notification_Class	Unsigned	-	O	R*
Feedback_Value	Unsigned	-	O	W
Event_Enable	BACnetEventTransitionBits	-	O	R*
Acked_Transitions	BACnetEventTransitionBits	-	O	R*
Notify_Type	BACnetNotifyType	-	O	R*
Event_Time_Stamps	BACnetArray[N] of BACnetTimeStamp	-	O	R*
Profile_Name	CharacterString	-	O	-

* Only available when specific object has a Notification Class configured

Mode CHILLER table (see next page)

Mode CHILLER table

Mode Chiller interpretation is possible using the value in the following correspondence table.

Pesent_Value	Contents displayed in State_Text
1	Heat
2	Not Valid
3	Not Valid
4	Cool
5	Not Valid
6	Cool Storage
7	Heat Storage

5.3.21 OxxUxx_Setpoint_S (Analog Input Object Type)

Property Identifier	Property Datatype	Value	ASHRAE	IBOX
Object_Identifier	BACnetObjectIdentifier	(Analog Input, (xxx*100) + 0)	R	R
Object_Name	CharacterString	<i>OxxUxx_Setpoint_S</i>	R	R
Object_Type	BACnetObjectType	ANALOG_INPUT (0)	R	R
Present_Value	REAL	x	R	R
Description	CharacterString	-	O	-
Device_Type	CharacterString	-	O	-
Status_Flags	BACnetStatusFlags	{FALSE, FALSE/TRUE, FALSE, FALSE}	R	R
Event_State	BACnetEventState	STATE_NORMAL (0)	R	R
Reliability	BACnetReliability	NO_FAULT_DETECTED (0), UNRELIABLE_OTHER (7)	O	R
Out_Of_Service	BOOLEAN	FALSE	R	R
Update_Interval	Unsigned	-	O	-
Units	BACnetEngineeringUnits	<i>degrees_Celsius</i>	R	R
Min_Pres_Value	REAL	-	O	-
Max_Pres_Value	REAL	-	O	-
Resolution	REAL	-	O	-
COV_Increment	REAL	0	O	R
Time_Delay	Unsigned	-	O	R*
Notification_Class	Unsigned	-	O	R*
High_Limit	REAL	-	O	R*
Low_Limit	REAL	-	O	R*
Deadband	REAL	-	O	R*
Limit_Enable	BACnetLimitEnable	-	O	R*
Event_Enable	BACnetEventTransitionBits	-	O	R*
Acked_Transitions	BACnetEventTransitionBits	-	O	R*
Notify_Type	BACnetNotifyType	-	O	R*
Event_Time_Stamps	BACnetArray[N] of BACnetTimeStamp	-	O	R*
Profile_Name	CharacterString	-	O	-

* Only available when specific object has a Notification Class configured

5.3.22 OxxUxx_Setpoint_C (Analog Output Object Type)

Property Identifier	Property Datatype	Value	ASHRAE	IBOX
Object_Identifier	BACnetObjectIdentifier	(Analog Output, (xxx*100) + 0)	R	R
Object_Name	CharacterString	<i>OxxUxx_Setpoint_C</i>	R	R
Object_Type	BACnetObjectType	ANALOG_OUTPUT (1)	R	R
Present_Value	REAL	x	W	W
Description	CharacterString	-	O	-
Device_Type	CharacterString	-	O	-
Status_Flags	BACnetStatusFlags	{FALSE, FALSE, FALSE, FALSE}	R	R
Event_State	BACnetEventState	STATE_NORMAL (0)	R	R
Reliability	BACnetReliability	NO_FAULT_DETECTED (0)	O	R
Out_Of_Service	BOOLEAN	FALSE	R	R
Update_Interval	Unsigned	-	O	-
Units	BACnetEngineeringUnits	<i>degrees_Celsius</i>	R	R
Min_Pres_Value	REAL	-	O	-
Max_Pres_Value	REAL	-	O	-
Resolution	REAL	-	O	-
COV_Increment	REAL	0	O	R
Priority_Array	BACnetPriorityArray	BACnetPriorityArray	R	R
Relinquish_Default	Unsigned	<i>Configurable through BACnet and Config Tool</i>	R	R
Time_Delay	Unsigned	-	O	R*
Notification_Class	Unsigned	-	O	R*
High_Limit	REAL	-	O	R*
Low_Limit	REAL	-	O	R*
Deadband	REAL	-	O	R*
Limit_Enable	BACnetLimitEnable	-	O	R*
Event_Enable	BACnetEventTransitionBits	-	O	R*
Acked_Transitions	BACnetEventTransitionBits	-	O	R*
Notify_Type	BACnetNotifyType	-	O	R*
Event_Time_Stamps	BACnetArray[N] of BACnetTimeStamp	-	O	R*
Profile_Name	CharacterString	-	O	-

* Only available when specific object has a Notification Class configured

5.3.23 OxxUxx_FanSpeed_S (Multistate Input Object Type)

Property Identifier	Property Datatype	Value	ASHRAE	IBOX
Object_Identifier	BACnetObjectIdentifier	(Multi-state Input, (xxx*100) + 0)	R	R
Object_Name	CharacterString	<i>OxxUxx_FanSpeed_S</i>	R	R
Object_Type	BACnetObjectType	MULTISTATE_INPUT (13)	R	R
Present_Value	Unsigned	x	R	R
Description	CharacterString	-	O	-
Device_Type	CharacterString	-	O	-
Status_Flags	BACnetStatusFlags	{FALSE, FALSE/TRUE, FALSE, FALSE}	R	R
Event_State	BACnetEventState	STATE_NORMAL (0)	R	R
Reliability	BACnetReliability	NO_FAULT_DETECTED (0), UNRELIABLE_OTHER (7)	O	R
Out_Of_Service	BOOLEAN	FALSE	R	R
Number_Of_States	Unsigned	4	R	R
State_Text	BACnetArray[N] of CharacterString	<i>Check FanSpeed table below</i>	O	R
Time_Delay	Unsigned	-	O	R*
Notification_Class	Unsigned	-	O	R*
Alarm_Values	List of Unsigned	-	O	R*
Fault_Values	List of Unsigned	-	O	R*
Event_Enable	BACnetEventTransitionBits	-	O	R*
Acked_Transitions	BACnetEventTransitionBits	-	O	R*
Notify_Type	BACnetNotifyType	-	O	R*
Event_Time_Stamps	BACnetArray[N] of BACnetTimeStamp	-	O	R*
Profile_Name	CharacterString	-	O	-

* Only available when specific object has a Notification Class configured

FanSpeed table

FanSpeed interpretation is possible using the value in the following correspondence table.

Present_Value	Contents displayed in State_Text
1	Low
2	Mid
3	High
4	Auto

5.3.24 OxxUxx_FanSpeed_C (Multistate Output Object Type)

Property Identifier	Property Datatype	Value	ASHRAE	IBOX
Object_Identifier	BACnetObjectIdentifier	(Multi-state Output, (xxx*100) + 0)	R	R
Object_Name	CharacterString	<i>OxxUxx_FanSpeed_C</i>	R	R
Object_Type	BACnetObjectType	MULTISTATE_OUTPUT (14)	R	R
Present_Value	Unsigned	x	W	W
Description	CharacterString	-	O	-
Device_Type	CharacterString	-	O	-
Status_Flags	BACnetStatusFlags	{FALSE, FALSE, FALSE, FALSE}	R	R
Event_State	BACnetEventState	STATE_NORMAL (0)	R	R
Reliability	BACnetReliability	NO_FAULT_DETECTED (0)	O	R
Out_Of_Service	BOOLEAN	FALSE	R	R
Number_Of_States	Unsigned	4	R	R
State_Text	BACnetArray[N] of CharacterString	<i>Check FanSpeed table below</i>	O	R
Priority_Array	BACnetPriorityArray	BACnetPriorityArray	R	R
Relinquish_Default	Unsigned	1	R	R
Time_Delay	Unsigned	-	O	R*
Notification_Class	Unsigned	-	O	R*
Feedback_Value	Unsigned	-	O	W
Event_Enable	BACnetEventTransitionBits	-	O	R*
Acked_Transitions	BACnetEventTransitionBits	-	O	R*
Notify_Type	BACnetNotifyType	-	O	R*
Event_Time_Stamps	BACnetArray[N] of BACnetTimeStamp	-	O	R*
Profile_Name	CharacterString	-	O	-

* Only available when specific object has a Notification Class configured

FanSpeed table

FanSpeed interpretation is possible using the value in the following correspondence table.

Present_Value	Contents displayed in State_Text
1	Low
2	Mid
3	High
4	Auto

5.3.25 OxxUxx_Vane position swing_S (Binary Input Object Type)

Property Identifier	Property Datatype	Value	ASHRAE	IBOX
Object_Identifier	BACnetObjectIdentifier	(Binary Input, (xxx*100) + 1)	R	R
Object_Name	CharacterString	<i>OxxUxx_Vane position swing_S</i>	R	R
Object_Type	BACnetObjectType	BINARY_INPUT (3)	R	R
Present_Value	BACnetBinaryPV	INACTIVE (0) / ACTIVE (1)	R	R
Description	CharacterString	-	O	-
Device_Type	CharacterString	-	O	-
Status_Flags	BACnetStatusFlags	{FALSE, FALSE/TRUE, FALSE, FALSE}	R	R
Event_State	BACnetEventState	STATE_NORMAL (0)	R	R
Reliability	BACnetReliability	NO_FAULT_DETECTED (0), UNRELIABLE_OTHER (7)	O	R
Out_Of_Service	BOOLEAN	FALSE	R	R
Polarity	BACnetPolarity	NORMAL (0)	R	R
Inactive_Text	CharacterString	"Off"	O	R
Active_Text	CharacterString	"On"	O	R
Change_Of_State_Time	BACnetDatetime	-	O	R
Change_Of_State_Count	Unsigned	-	O	R
Time_Of_State_Count_Reset	BACnetDatetime	-	O	R
Elapsed_Active_Time	Unsigned	-	O	R
Time_Of_Active_Time_Reset	BACnetDatetime	-	O	R
Time_Delay	Unsigned	-	O	R*
Notification_Class	Unsigned	-	O	R*
Alarm_Value	BACnetBinaryPV	-	O	R*
Event_Enable	BACnetEventTransitionBits	-	O	R*
Acked_Transitions	BACnetEventTransitionBits	-	O	R*
Notify_Type	BACnetNotifyType	-	O	R*
Event_Time_Stamps	BACnetArray[N] of BACnetTimeStamp	-	O	R*
Profile_Name	CharacterString	-	O	-

* Only available when specific object has a Notification Class configured

5.3.26 OxxUxx_Vane position swing_C (Binary Output Object Type)

Property Identifier	Property Datatype	Value	ASHRAE	IBOX
Object_Identifier	BACnetObjectIdentifier	(Binary Output, (xxx*100) + 1)	R	R
Object_Name	CharacterString	<i>OxxUxx_Vane position swing_C</i>	R	R
Object_Type	BACnetObjectType	BINARY_OUTPUT (4)	R	R
Present_Value	BACnetBinaryPV	INACTIVE (0) / ACTIVE (1)	W	W
Description	CharacterString	-	O	-
Device_Type	CharacterString	-	O	-
Status_Flags	BACnetStatusFlags	{FALSE, FALSE, FALSE, FALSE}	R	R
Event_State	BACnetEventState	STATE_NORMAL (0)	R	R
Reliability	BACnetReliability	NO_FAULT_DETECTED (0)	O	R
Out_Of_Service	BOOLEAN	FALSE	R	R
Polarity	BACnetPolarity	NORMAL (0)	R	R
Inactive_Text	CharacterString	"Off"	O	R
Active_Text	CharacterString	"On"	O	R
Change_Of_State_Time	BACnetDatetime	-	O	R
Change_Of_State_Count	Unsigned	-	O	R
Time_Of_State_Count_Reset	BACnetDatetime	-	O	R
Elapsed_Active_Time	Unsigned	-	O	R
Time_Of_Active_Time_Reset	BACnetDatetime	-	O	R
Minimum_Off_Time	Unsigned32	-	O	-
Minimum_On_Time	Unsigned32	-	O	-
Priority_Array	BACnetPriorityArray	BACnetPriorityArray	R	R
Relinquish_Default	BACnetBinaryPV	INACTIVE (0)	R	R
Time_Delay	Unsigned	-	O	R*
Notification_Class	Unsigned	-	O	R*
Feedback_Value	BACnetBinaryPV	-	O	W
Event_Enable	BACnetEventTransitionBits	-	O	R*
Acked_Transitions	BACnetEventTransitionBits	-	O	R*
Notify_Type	BACnetNotifyType	-	O	R*
Event_Time_Stamps	BACnetArray[N] of BACnetTimeStamp	-	O	R*
Profile_Name	CharacterString	-	O	-

* Only available when specific object has a Notification Class configured

5.3.27 OxxUxx_Room_Temperature (Analog Input Object Type)

Property Identifier	Property Datatype	Value	ASHRAE	IBOX
Object_Identifier	BACnetObjectIdentifier	(Analog Input, (xxx*100) + 1)	R	R
Object_Name	CharacterString	<i>OxxUxx_Room_Temperature</i>	R	R
Object_Type	BACnetObjectType	ANALOG_INPUT (0)	R	R
Present_Value	REAL	x	R	R
Description	CharacterString	-	O	-
Device_Type	CharacterString	-	O	-
Status_Flags	BACnetStatusFlags	{FALSE, FALSE/TRUE, FALSE, FALSE}	R	R
Event_State	BACnetEventState	STATE_NORMAL (0)	R	R
Reliability	BACnetReliability	NO_FAULT_DETECTED (0), UNRELIABLE_OTHER (7)	O	R
Out_Of_Service	BOOLEAN	FALSE	R	R
Update_Interval	Unsigned	-	O	-
Units	BACnetEngineeringUnits	<i>degrees_Celsius</i>	R	R
Min_Pres_Value	REAL	-	O	-
Max_Pres_Value	REAL	-	O	-
Resolution	REAL	-	O	-
COV_Increment	REAL	0	O	R
Time_Delay	Unsigned	-	O	R*
Notification_Class	Unsigned	-	O	R*
High_Limit	REAL	-	O	R*
Low_Limit	REAL	-	O	R*
Deadband	REAL	-	O	R*
Limit_Enable	BACnetLimitEnable	-	O	R*
Event_Enable	BACnetEventTransitionBits	-	O	R*
Acked_Transitions	BACnetEventTransitionBits	-	O	R*
Notify_Type	BACnetNotifyType	-	O	R*
Event_Time_Stamps	BACnetArray[N] of BACnetTimeStamp	-	O	R*
Profile_Name	CharacterString	-	O	-

* Only available when specific object has a Notification Class configured

5.3.28 OxxUxx_Disch.Setpoint Cool IU_S (Analog Input Object Type)

Property Identifier	Property Datatype	Value	ASHRAE	IBOX
Object_Identifier	BACnetObjectIdentifier	(Analog Input, (xxx*100) + 2)	R	R
Object_Name	CharacterString	<i>OxxUxx_Disch.Setpoint Cool IU_S</i>	R	R
Object_Type	BACnetObjectType	ANALOG_INPUT (0)	R	R
Present_Value	REAL	x	R	R
Description	CharacterString	-	O	-
Device_Type	CharacterString	-	O	-
Status_Flags	BACnetStatusFlags	{FALSE, FALSE/TRUE, FALSE, FALSE}	R	R
Event_State	BACnetEventState	STATE_NORMAL (0)	R	R
Reliability	BACnetReliability	NO_FAULT_DETECTED (0), UNRELIABLE_OTHER (7)	O	R
Out_Of_Service	BOOLEAN	FALSE	R	R
Update_Interval	Unsigned	-	O	-
Units	BACnetEngineeringUnits	<i>degrees_Celsius</i>	R	R
Min_Pres_Value	REAL	-	O	-
Max_Pres_Value	REAL	-	O	-
Resolution	REAL	-	O	-
COV_Increment	REAL	0	O	R
Time_Delay	Unsigned	-	O	R*
Notification_Class	Unsigned	-	O	R*
High_Limit	REAL	-	O	R*
Low_Limit	REAL	-	O	R*
Deadband	REAL	-	O	R*
Limit_Enable	BACnetLimitEnable	-	O	R*
Event_Enable	BACnetEventTransitionBits	-	O	R*
Acked_Transitions	BACnetEventTransitionBits	-	O	R*
Notify_Type	BACnetNotifyType	-	O	R*
Event_Time_Stamps	BACnetArray[N] of BACnetTimeStamp	-	O	R*
Profile_Name	CharacterString	-	O	-

* Only available when specific object has a Notification Class configured

5.3.29 OxxUxx_Disch.Setpoint Cool IU_C (Analog Output Object Type)

Property Identifier	Property Datatype	Value	ASHRAE	IBOX
Object_Identifier	BACnetObjectIdentifier	(Analog Output, (xxx*100) + 1)	R	R
Object_Name	CharacterString	<i>OxxUxx_Disch.Setpoint Cool IU_C</i>	R	R
Object_Type	BACnetObjectType	ANALOG_OUTPUT (1)	R	R
Present_Value	REAL	x	W	W
Description	CharacterString	-	O	-
Device_Type	CharacterString	-	O	-
Status_Flags	BACnetStatusFlags	{FALSE, FALSE, FALSE, FALSE}	R	R
Event_State	BACnetEventState	STATE_NORMAL (0)	R	R
Reliability	BACnetReliability	NO_FAULT_DETECTED (0)	O	R
Out_Of_Service	BOOLEAN	FALSE	R	R
Update_Interval	Unsigned	-	O	-
Units	BACnetEngineeringUnits	<i>degrees_Celsius</i>	R	R
Min_Pres_Value	REAL	-	O	-
Max_Pres_Value	REAL	-	O	-
Resolution	REAL	-	O	-
COV_Increment	REAL	0	O	R
Priority_Array	BACnetPriorityArray	BACnetPriorityArray	R	R
Relinquish_Default	Unsigned	<i>Configurable through BACnet and Config Tool</i>	R	R
Time_Delay	Unsigned	-	O	R*
Notification_Class	Unsigned	-	O	R*
High_Limit	REAL	-	O	R*
Low_Limit	REAL	-	O	R*
Deadband	REAL	-	O	R*
Limit_Enable	BACnetLimitEnable	-	O	R*
Event_Enable	BACnetEventTransitionBits	-	O	R*
Acked_Transitions	BACnetEventTransitionBits	-	O	R*
Notify_Type	BACnetNotifyType	-	O	R*
Event_Time_Stamps	BACnetArray[N] of BACnetTimeStamp	-	O	R*
Profile_Name	CharacterString	-	O	-

* Only available when specific object has a Notification Class configured

5.3.30 OxxUxx_Disch.Setpoint Cool AHU_S (Analog Input Object Type)

Property Identifier	Property Datatype	Value	ASHRAE	IBOX
Object_Identifier	BACnetObjectIdentifier	(Analog Input, (xxx*100) + 2)	R	R
Object_Name	CharacterString	<i>OxxUxx_Disch.Setpoint Cool AHU_S</i>	R	R
Object_Type	BACnetObjectType	ANALOG_INPUT (0)	R	R
Present_Value	REAL	x	R	R
Description	CharacterString	-	O	-
Device_Type	CharacterString	-	O	-
Status_Flags	BACnetStatusFlags	{FALSE, FALSE/TRUE, FALSE, FALSE}	R	R
Event_State	BACnetEventState	STATE_NORMAL (0)	R	R
Reliability	BACnetReliability	NO_FAULT_DETECTED (0), UNRELIABLE_OTHER (7)	O	R
Out_Of_Service	BOOLEAN	FALSE	R	R
Update_Interval	Unsigned	-	O	-
Units	BACnetEngineeringUnits	<i>degrees_Celsius</i>	R	R
Min_Pres_Value	REAL	-	O	-
Max_Pres_Value	REAL	-	O	-
Resolution	REAL	-	O	-
COV_Increment	REAL	0	O	R
Time_Delay	Unsigned	-	O	R*
Notification_Class	Unsigned	-	O	R*
High_Limit	REAL	-	O	R*
Low_Limit	REAL	-	O	R*
Deadband	REAL	-	O	R*
Limit_Enable	BACnetLimitEnable	-	O	R*
Event_Enable	BACnetEventTransitionBits	-	O	R*
Acked_Transitions	BACnetEventTransitionBits	-	O	R*
Notify_Type	BACnetNotifyType	-	O	R*
Event_Time_Stamps	BACnetArray[N] of BACnetTimeStamp	-	O	R*
Profile_Name	CharacterString	-	O	-

* Only available when specific object has a Notification Class configured

5.3.31 OxxUxx_Disch.Setpoint Cool AHU_C (Analog Output Object Type)

Property Identifier	Property Datatype	Value	ASHRAE	IBOX
Object_Identifier	BACnetObjectIdentifier	(Analog Output, (xxx*100) + 1)	R	R
Object_Name	CharacterString	<i>OxxUxx_Disch.Setpoint Cool AHU_C</i>	R	R
Object_Type	BACnetObjectType	ANALOG_OUTPUT (1)	R	R
Present_Value	REAL	x	W	W
Description	CharacterString	-	O	-
Device_Type	CharacterString	-	O	-
Status_Flags	BACnetStatusFlags	{FALSE, FALSE, FALSE, FALSE}	R	R
Event_State	BACnetEventState	STATE_NORMAL (0)	R	R
Reliability	BACnetReliability	NO_FAULT_DETECTED (0)	O	R
Out_Of_Service	BOOLEAN	FALSE	R	R
Update_Interval	Unsigned	-	O	-
Units	BACnetEngineeringUnits	<i>degrees_Celsius</i>	R	R
Min_Pres_Value	REAL	-	O	-
Max_Pres_Value	REAL	-	O	-
Resolution	REAL	-	O	-
COV_Increment	REAL	0	O	R
Priority_Array	BACnetPriorityArray	BACnetPriorityArray	R	R
Relinquish_Default	Unsigned	<i>Configurable through BACnet and Config Tool</i>	R	R
Time_Delay	Unsigned	-	O	R*
Notification_Class	Unsigned	-	O	R*
High_Limit	REAL	-	O	R*
Low_Limit	REAL	-	O	R*
Deadband	REAL	-	O	R*
Limit_Enable	BACnetLimitEnable	-	O	R*
Event_Enable	BACnetEventTransitionBits	-	O	R*
Acked_Transitions	BACnetEventTransitionBits	-	O	R*
Notify_Type	BACnetNotifyType	-	O	R*
Event_Time_Stamps	BACnetArray[N] of BACnetTimeStamp	-	O	R*
Profile_Name	CharacterString	-	O	-

* Only available when specific object has a Notification Class configured

5.3.32 OxxUxx_Disch.Setpoint Heat IU_S (Analog Input Object Type)

Property Identifier	Property Datatype	Value	ASHRAE	IBOX
Object_Identifier	BACnetObjectIdentifier	(Analog Input, (xxx*100) + 3)	R	R
Object_Name	CharacterString	<i>OxxUxx_Disch.Setpoint Heat IU_S</i>	R	R
Object_Type	BACnetObjectType	ANALOG_INPUT (0)	R	R
Present_Value	REAL	x	R	R
Description	CharacterString	-	O	-
Device_Type	CharacterString	-	O	-
Status_Flags	BACnetStatusFlags	{FALSE, FALSE/TRUE, FALSE, FALSE}	R	R
Event_State	BACnetEventState	STATE_NORMAL (0)	R	R
Reliability	BACnetReliability	NO_FAULT_DETECTED (0), UNRELIABLE_OTHER (7)	O	R
Out_Of_Service	BOOLEAN	FALSE	R	R
Update_Interval	Unsigned	-	O	-
Units	BACnetEngineeringUnits	<i>degrees_Celsius</i>	R	R
Min_Pres_Value	REAL	-	O	-
Max_Pres_Value	REAL	-	O	-
Resolution	REAL	-	O	-
COV_Increment	REAL	0	O	R
Time_Delay	Unsigned	-	O	R*
Notification_Class	Unsigned	-	O	R*
High_Limit	REAL	-	O	R*
Low_Limit	REAL	-	O	R*
Deadband	REAL	-	O	R*
Limit_Enable	BACnetLimitEnable	-	O	R*
Event_Enable	BACnetEventTransitionBits	-	O	R*
Acked_Transitions	BACnetEventTransitionBits	-	O	R*
Notify_Type	BACnetNotifyType	-	O	R*
Event_Time_Stamps	BACnetArray[N] of BACnetTimeStamp	-	O	R*
Profile_Name	CharacterString	-	O	-

* Only available when specific object has a Notification Class configured

5.3.33 OxxUxx_Disch.Setpoint Heat IU_C (Analog Output Object Type)

Property Identifier	Property Datatype	Value	ASHRAE	IBOX
Object_Identifier	BACnetObjectIdentifier	(Analog Output, (xxx*100) + 2)	R	R
Object_Name	CharacterString	<i>OxxUxx_Disch.Setpoint Heat IU_C</i>	R	R
Object_Type	BACnetObjectType	ANALOG_OUTPUT (1)	R	R
Present_Value	REAL	x	W	W
Description	CharacterString	-	O	-
Device_Type	CharacterString	-	O	-
Status_Flags	BACnetStatusFlags	{FALSE, FALSE, FALSE, FALSE}	R	R
Event_State	BACnetEventState	STATE_NORMAL (0)	R	R
Reliability	BACnetReliability	NO_FAULT_DETECTED (0)	O	R
Out_Of_Service	BOOLEAN	FALSE	R	R
Update_Interval	Unsigned	-	O	-
Units	BACnetEngineeringUnits	<i>degrees_Celsius</i>	R	R
Min_Pres_Value	REAL	-	O	-
Max_Pres_Value	REAL	-	O	-
Resolution	REAL	-	O	-
COV_Increment	REAL	0	O	R
Priority_Array	BACnetPriorityArray	BACnetPriorityArray	R	R
Relinquish_Default	Unsigned	<i>Configurable through BACnet and Config Tool</i>	R	R
Time_Delay	Unsigned	-	O	R*
Notification_Class	Unsigned	-	O	R*
High_Limit	REAL	-	O	R*
Low_Limit	REAL	-	O	R*
Deadband	REAL	-	O	R*
Limit_Enable	BACnetLimitEnable	-	O	R*
Event_Enable	BACnetEventTransitionBits	-	O	R*
Acked_Transitions	BACnetEventTransitionBits	-	O	R*
Notify_Type	BACnetNotifyType	-	O	R*
Event_Time_Stamps	BACnetArray[N] of BACnetTimeStamp	-	O	R*
Profile_Name	CharacterString	-	O	-

* Only available when specific object has a Notification Class configured

5.3.34 OxxUxx_Disch.Setpoint Heat AHU_S (Analog Input Object Type)

Property Identifier	Property Datatype	Value	ASHRAE	IBOX
Object_Identifier	BACnetObjectIdentifier	(Analog Input, (xxx*100) + 3)	R	R
Object_Name	CharacterString	<i>OxxUxx_Disch.Setpoint Heat AHU_S</i>	R	R
Object_Type	BACnetObjectType	ANALOG_INPUT (0)	R	R
Present_Value	REAL	x	R	R
Description	CharacterString	-	O	-
Device_Type	CharacterString	-	O	-
Status_Flags	BACnetStatusFlags	{FALSE, FALSE/TRUE, FALSE, FALSE}	R	R
Event_State	BACnetEventState	STATE_NORMAL (0)	R	R
Reliability	BACnetReliability	NO_FAULT_DETECTED (0), UNRELIABLE_OTHER (7)	O	R
Out_Of_Service	BOOLEAN	FALSE	R	R
Update_Interval	Unsigned	-	O	-
Units	BACnetEngineeringUnits	<i>degrees_Celsius</i>	R	R
Min_Pres_Value	REAL	-	O	-
Max_Pres_Value	REAL	-	O	-
Resolution	REAL	-	O	-
COV_Increment	REAL	0	O	R
Time_Delay	Unsigned	-	O	R*
Notification_Class	Unsigned	-	O	R*
High_Limit	REAL	-	O	R*
Low_Limit	REAL	-	O	R*
Deadband	REAL	-	O	R*
Limit_Enable	BACnetLimitEnable	-	O	R*
Event_Enable	BACnetEventTransitionBits	-	O	R*
Acked_Transitions	BACnetEventTransitionBits	-	O	R*
Notify_Type	BACnetNotifyType	-	O	R*
Event_Time_Stamps	BACnetArray[N] of BACnetTimeStamp	-	O	R*
Profile_Name	CharacterString	-	O	-

* Only available when specific object has a Notification Class configured

5.3.35 OxxUxx_Disch.Setpoint Heat IU_C (Analog Output Object Type)

Property Identifier	Property Datatype	Value	ASHRAE	IBOX
Object_Identifier	BACnetObjectIdentifier	(Analog Output, (xxx*100) + 2)	R	R
Object_Name	CharacterString	<i>OxxUxx_Disch.Setpoint Heat IU_C</i>	R	R
Object_Type	BACnetObjectType	ANALOG_OUTPUT (1)	R	R
Present_Value	REAL	x	W	W
Description	CharacterString	-	O	-
Device_Type	CharacterString	-	O	-
Status_Flags	BACnetStatusFlags	{FALSE, FALSE, FALSE, FALSE}	R	R
Event_State	BACnetEventState	STATE_NORMAL (0)	R	R
Reliability	BACnetReliability	NO_FAULT_DETECTED (0)	O	R
Out_Of_Service	BOOLEAN	FALSE	R	R
Update_Interval	Unsigned	-	O	-
Units	BACnetEngineeringUnits	<i>degrees_Celsius</i>	R	R
Min_Pres_Value	REAL	-	O	-
Max_Pres_Value	REAL	-	O	-
Resolution	REAL	-	O	-
COV_Increment	REAL	0	O	R
Priority_Array	BACnetPriorityArray	BACnetPriorityArray	R	R
Relinquish_Default	Unsigned	<i>Configurable through BACnet and Config Tool</i>	R	R
Time_Delay	Unsigned	-	O	R*
Notification_Class	Unsigned	-	O	R*
High_Limit	REAL	-	O	R*
Low_Limit	REAL	-	O	R*
Deadband	REAL	-	O	R*
Limit_Enable	BACnetLimitEnable	-	O	R*
Event_Enable	BACnetEventTransitionBits	-	O	R*
Acked_Transitions	BACnetEventTransitionBits	-	O	R*
Notify_Type	BACnetNotifyType	-	O	R*
Event_Time_Stamps	BACnetArray[N] of BACnetTimeStamp	-	O	R*
Profile_Name	CharacterString	-	O	-

* Only available when specific object has a Notification Class configured

5.3.36 OxxUxx_Disch. Current Temp. S (Analog Input Object Type)

Property Identifier	Property Datatype	Value	ASHRAE	IBOX
Object_Identifier	BACnetObjectIdentifier	(Analog Input, (xxx*100) + 4)	R	R
Object_Name	CharacterString	<i>OxxUxx_Disch. Current Temp.</i>	R	R
Object_Type	BACnetObjectType	ANALOG_INPUT (0)	R	R
Present_Value	REAL	x	R	R
Description	CharacterString	-	O	-
Device_Type	CharacterString	-	O	-
Status_Flags	BACnetStatusFlags	{FALSE, FALSE/TRUE, FALSE, FALSE}	R	R
Event_State	BACnetEventState	STATE_NORMAL (0)	R	R
Reliability	BACnetReliability	NO_FAULT_DETECTED (0), UNRELIABLE_OTHER (7)	O	R
Out_Of_Service	BOOLEAN	FALSE	R	R
Update_Interval	Unsigned	-	O	-
Units	BACnetEngineeringUnits	<i>degrees_Celsius</i>	R	R
Min_Pres_Value	REAL	-	O	-
Max_Pres_Value	REAL	-	O	-
Resolution	REAL	-	O	-
COV_Increment	REAL	0	O	R
Time_Delay	Unsigned	-	O	R*
Notification_Class	Unsigned	-	O	R*
High_Limit	REAL	-	O	R*
Low_Limit	REAL	-	O	R*
Deadband	REAL	-	O	R*
Limit_Enable	BACnetLimitEnable	-	O	R*
Event_Enable	BACnetEventTransitionBits	-	O	R*
Acked_Transitions	BACnetEventTransitionBits	-	O	R*
Notify_Type	BACnetNotifyType	-	O	R*
Event_Time_Stamps	BACnetArray[N] of BACnetTimeStamp	-	O	R*
Profile_Name	CharacterString	-	O	-

* Only available when specific object has a Notification Class configured

5.3.37 OxxUxx_Unit Error code (Analog Input Object Type)

Property Identifier	Property Datatype	Value	ASHRAE	IBOX
Object_Identifier	BACnetObjectIdentifier	(Analog Input, (xxx*100) + 5)	R	R
Object_Name	CharacterString	<i>OxxUxx_Unit Error code</i>	R	R
Object_Type	BACnetObjectType	ANALOG_INPUT (0)	R	R
Present_Value	REAL	NO ERROR (0) / X-ERROR (10000999)	R	R
Description	CharacterString	-	O	-
Device_Type	CharacterString	-	O	-
Status_Flags	BACnetStatusFlags	{FALSE, FALSE/TRUE, FALSE, FALSE}	R	R
Event_State	BACnetEventState	STATE_NORMAL (0)	R	R
Reliability	BACnetReliability	NO_FAULT_DETECTED (0), UNRELIABLE_OTHER (7)	O	R
Out_Of_Service	BOOLEAN	FALSE	R	R
Update_Interval	Unsigned	-	O	-
Units	BACnetEngineeringUnits	<i>no_units</i>	R	R
Min_Pres_Value	REAL	-	O	-
Max_Pres_Value	REAL	-	O	-
Resolution	REAL	-	O	-
COV_Increment	REAL	0	O	R
Time_Delay	Unsigned	-	O	R*
Notification_Class	Unsigned	-	O	R*
High_Limit	REAL	-	O	R*
Low_Limit	REAL	-	O	R*
Deadband	REAL	-	O	R*
Limit_Enable	BACnetLimitEnable	-	O	R*
Event_Enable	BACnetEventTransitionBits	-	O	R*
Acked_Transitions	BACnetEventTransitionBits	-	O	R*
Notify_Type	BACnetNotifyType	-	O	R*
Event_Time_Stamps	BACnetArray[N] of BACnetTimeStamp	-	O	R*
Profile_Name	CharacterString	-	O	-

* Only available when specific object has a Notification Class configured

5.3.38 OxxUxx_Error Slave Chiller Unit (Analog Input Object Type)

Property Identifier	Property Datatype	Value	ASHRAE	IBOX
Object_Identifier	BACnetObjectIdentifier	(Analog Input, (xxx*100) + 6)	R	R
Object_Name	CharacterString	<i>OxxUxx_Error Slave Chiller Unit</i>	R	R
Object_Type	BACnetObjectType	ANALOG_INPUT (0)	R	R
Present_Value	REAL	x	R	R
Description	CharacterString	-	O	-
Device_Type	CharacterString	-	O	-
Status_Flags	BACnetStatusFlags	{FALSE, FALSE/TRUE, FALSE, FALSE}	R	R
Event_State	BACnetEventState	STATE_NORMAL (0)	R	R
Reliability	BACnetReliability	NO_FAULT_DETECTED (0), UNRELIABLE_OTHER (7)	O	R
Out_Of_Service	BOOLEAN	FALSE	R	R
Update_Interval	Unsigned	-	O	-
Units	BACnetEngineeringUnits	<i>no_units</i>	R	R
Min_Pres_Value	REAL	-	O	-
Max_Pres_Value	REAL	-	O	-
Resolution	REAL	-	O	-
COV_Increment	REAL	0	O	R
Time_Delay	Unsigned	-	O	R*
Notification_Class	Unsigned	-	O	R*
High_Limit	REAL	-	O	R*
Low_Limit	REAL	-	O	R*
Deadband	REAL	-	O	R*
Limit_Enable	BACnetLimitEnable	-	O	R*
Event_Enable	BACnetEventTransitionBits	-	O	R*
Acked_Transitions	BACnetEventTransitionBits	-	O	R*
Notify_Type	BACnetNotifyType	-	O	R*
Event_Time_Stamps	BACnetArray[N] of BACnetTimeStamp	-	O	R*
Profile_Name	CharacterString	-	O	-

* Only available when specific object has a Notification Class configured

5.3.39 OxxUxx_Slave Chiller in Error (Analog Input Object Type)

Property Identifier	Property Datatype	Value	ASHRAE	IBOX
Object_Identifier	BACnetObjectIdentifier	(Analog Input, (xxx*100) + 7)	R	R
Object_Name	CharacterString	<i>OxxUxx_Slave Chiller in Error</i>	R	R
Object_Type	BACnetObjectType	ANALOG_INPUT (0)	R	R
Present_Value	REAL	x	R	R
Description	CharacterString	-	O	-
Device_Type	CharacterString	-	O	-
Status_Flags	BACnetStatusFlags	{FALSE, FALSE/TRUE, FALSE, FALSE}	R	R
Event_State	BACnetEventState	STATE_NORMAL (0)	R	R
Reliability	BACnetReliability	NO_FAULT_DETECTED (0), UNRELIABLE_OTHER (7)	O	R
Out_Of_Service	BOOLEAN	FALSE	R	R
Update_Interval	Unsigned	-	O	-
Units	BACnetEngineeringUnits	<i>no_units</i>	R	R
Min_Pres_Value	REAL	-	O	-
Max_Pres_Value	REAL	-	O	-
Resolution	REAL	-	O	-
COV_Increment	REAL	0	O	R
Time_Delay	Unsigned	-	O	R*
Notification_Class	Unsigned	-	O	R*
High_Limit	REAL	-	O	R*
Low_Limit	REAL	-	O	R*
Deadband	REAL	-	O	R*
Limit_Enable	BACnetLimitEnable	-	O	R*
Event_Enable	BACnetEventTransitionBits	-	O	R*
Acked_Transitions	BACnetEventTransitionBits	-	O	R*
Notify_Type	BACnetNotifyType	-	O	R*
Event_Time_Stamps	BACnetArray[N] of BACnetTimeStamp	-	O	R*
Profile_Name	CharacterString	-	O	-

* Only available when specific object has a Notification Class configured

5.3.40 OxxUxx_FilterSign (Binary Input Object Type)

Property Identifier	Property Datatype	Value	ASHRAE	IBOX
Object_Identifier	BACnetObjectIdentifier	(Binary Input, (xxx*100) + 2)	R	R
Object_Name	CharacterString	<i>OxxUxx_FilterSign</i>	R	R
Object_Type	BACnetObjectType	BINARY_INPUT (3)	R	R
Present_Value	BACnetBinaryPV	INACTIVE (0) / ACTIVE (1)	R	R
Description	CharacterString	-	O	-
Device_Type	CharacterString	-	O	-
Status_Flags	BACnetStatusFlags	{FALSE, FALSE/TRUE, FALSE, FALSE}	R	R
Event_State	BACnetEventState	STATE_NORMAL (0)	R	R
Reliability	BACnetReliability	NO_FAULT_DETECTED (0), UNRELIABLE_OTHER (7)	O	R
Out_Of_Service	BOOLEAN	FALSE	R	R
Polarity	BACnetPolarity	NORMAL (0)	R	R
Inactive_Text	CharacterString	<i>"Normal"</i>	O	R
Active_Text	CharacterString	<i>"Alarm"</i>	O	R
Change_Of_State_Time	BACnetDatetime	-	O	R
Change_Of_State_Count	Unsigned	-	O	R
Time_Of_State_Count_Reset	BACnetDatetime	-	O	R
Elapsed_Active_Time	Unsigned	-	O	R
Time_Of_Active_Time_Reset	BACnetDatetime	-	O	R
Time_Delay	Unsigned	-	O	R*
Notification_Class	Unsigned	-	O	R*
Alarm_Value	BACnetBinaryPV	-	O	R*
Event_Enable	BACnetEventTransitionBits	-	O	R*
Acked_Transitions	BACnetEventTransitionBits	-	O	R*
Notify_Type	BACnetNotifyType	-	O	R*
Event_Time_Stamps	BACnetArray[N] of BACnetTimeStamp	-	O	R*
Profile_Name	CharacterString	-	O	-

* Only available when specific object has a Notification Class configured

5.3.41 OxxUxx_FilterReset (Binary Output Object Type)

Property Identifier	Property Datatype	Value	ASHRAE	IBOX
Object_Identifier	BACnetObjectIdentifier	(Binary Output, (xxx*100) + 2)	R	R
Object_Name	CharacterString	<i>OxxUxx_FilterReset</i>	R	R
Object_Type	BACnetObjectType	BINARY_OUTPUT (4)	R	R
Present_Value	BACnetBinaryPV	INACTIVE (0) / ACTIVE (1)	W	W
Description	CharacterString	-	O	-
Device_Type	CharacterString	-	O	-
Status_Flags	BACnetStatusFlags	{FALSE, FALSE, FALSE, FALSE}	R	R
Event_State	BACnetEventState	STATE_NORMAL (0)	R	R
Reliability	BACnetReliability	NO_FAULT_DETECTED (0)	O	R
Out_Of_Service	BOOLEAN	FALSE	R	R
Polarity	BACnetPolarity	NORMAL (0)	R	R
Inactive_Text	CharacterString	<i>"No reset"</i>	O	R
Active_Text	CharacterString	<i>"Reset"</i>	O	R
Change_Of_State_Time	BACnetDatetime	-	O	R
Change_Of_State_Count	Unsigned	-	O	R
Time_Of_State_Count_Reset	BACnetDatetime	-	O	R
Elapsed_Active_Time	Unsigned	-	O	R
Time_Of_Active_Time_Reset	BACnetDatetime	-	O	R
Minimum_Off_Time	Unsigned32	-	O	-
Minimum_On_Time	Unsigned32	-	O	-
Priority_Array	BACnetPriorityArray	BACnetPriorityArray	R	R
Relinquish_Default	BACnetBinaryPV	INACTIVE (0)	R	R
Time_Delay	Unsigned	-	O	R*
Notification_Class	Unsigned	-	O	R*
Feedback_Value	BACnetBinaryPV	-	O	W
Event_Enable	BACnetEventTransitionBits	-	O	R*
Acked_Transitions	BACnetEventTransitionBits	-	O	R*
Notify_Type	BACnetNotifyType	-	O	R*
Event_Time_Stamps	BACnetArray[N] of BACnetTimeStamp	-	O	R*
Profile_Name	CharacterString	-	O	-

* Only available when specific object has a Notification Class configured

5.3.42 OxxUxx_Communication Status (Multistate Input Object Type)

Property Identifier	Property Datatype	Value	ASHRAE	IBOX
Object_Identifier	BACnetObjectIdentifier	(Multi-state Input, (xxx*100) + 0)	R	R
Object_Name	CharacterString	<i>OxxUxx_Communication Status</i>	R	R
Object_Type	BACnetObjectType	MULTISTATE_INPUT (13)	R	R
Present_Value	Unsigned	x	R	R
Description	CharacterString	-	O	-
Device_Type	CharacterString	-	O	-
Status_Flags	BACnetStatusFlags	{FALSE, FALSE/TRUE, FALSE, FALSE}	R	R
Event_State	BACnetEventState	STATE_NORMAL (0)	R	R
Reliability	BACnetReliability	NO_FAULT_DETECTED (0), UNRELIABLE_OTHER (7)	O	R
Out_Of_Service	BOOLEAN	FALSE	R	R
Number_Of_States	Unsigned	16	R	R
State_Text	BACnetArray[N] of CharacterString	Check Communication Status table <i>below</i>	O	R
Time_Delay	Unsigned	-	O	R*
Notification_Class	Unsigned	-	O	R*
Alarm_Values	List of Unsigned	-	O	R*
Fault_Values	List of Unsigned	-	O	R*
Event_Enable	BACnetEventTransitionBits	-	O	R*
Acked_Transitions	BACnetEventTransitionBits	-	O	R*
Notify_Type	BACnetNotifyType	-	O	R*
Event_Time_Stamps	BACnetArray[N] of BACnetTimeStamp	-	O	R*
Profile_Name	CharacterString	-	O	-

* Only available when specific object has a Notification Class configured

Communication Status table (see next page)

Communication Status table

Communication Status interpretation is possible using the value in the following correspondence table.

Pesent_Value	Contents displayed in State_Text
1	-/-/-
2	-/-/EXST
3	-/-RDY/-
4	-/-RDY/EXST
5	-/DTUP/-
6	-/DTUP/-EXST
7	-/DTUP/RDY/-
8	-/DTUP/RDY/EXST
9	TPOK/-/-
10	TPOK/-/EXST
11	TPOK/-RDY/-
12	TPOK/-RDY/EXST
13	TPOK/DTUP/-
14	TPOK/DTUP/-EXST
15	TPOK/DTUP/RDY/-
16	TPOK/DTUP/RDY/EXST

Where following is the meaning of each field:

- EXST: Unit found in bus
- RDY: Unit ready
- DTUP: Data from unit has been updated
- TPOK: Unit type in configuration is OK

5.3.43 OxxUxx_RC Restriction_S (Binary Input Object Type)

Property Identifier	Property Datatype	Value	ASHRAE	IBOX
Object_Identifier	BACnetObjectIdentifier	(Binary Input, (xxx*100) + 3)	R	R
Object_Name	CharacterString	<i>OxxUxx_FilterSign</i>	R	R
Object_Type	BACnetObjectType	BINARY_INPUT (3)	R	R
Present_Value	BACnetBinaryPV	INACTIVE (0) / ACTIVE (1)	R	R
Description	CharacterString	-	O	-
Device_Type	CharacterString	-	O	-
Status_Flags	BACnetStatusFlags	{FALSE, FALSE/TRUE, FALSE, FALSE}	R	R
Event_State	BACnetEventState	STATE_NORMAL (0)	R	R
Reliability	BACnetReliability	NO_FAULT_DETECTED (0), UNRELIABLE_OTHER (7)	O	R
Out_Of_Service	BOOLEAN	FALSE	R	R
Polarity	BACnetPolarity	NORMAL (0)	R	R
Inactive_Text	CharacterString	<i>"No restriction"</i>	O	R
Active_Text	CharacterString	<i>"Restriction"</i>	O	R
Change_Of_State_Time	BACnetDatetime	-	O	R
Change_Of_State_Count	Unsigned	-	O	R
Time_Of_State_Count_Reset	BACnetDatetime	-	O	R
Elapsed_Active_Time	Unsigned	-	O	R
Time_Of_Active_Time_Reset	BACnetDatetime	-	O	R
Time_Delay	Unsigned	-	O	R*
Notification_Class	Unsigned	-	O	R*
Alarm_Value	BACnetBinaryPV	-	O	R*
Event_Enable	BACnetEventTransitionBits	-	O	R*
Acked_Transitions	BACnetEventTransitionBits	-	O	R*
Notify_Type	BACnetNotifyType	-	O	R*
Event_Time_Stamps	BACnetArray[N] of BACnetTimeStamp	-	O	R*
Profile_Name	CharacterString	-	O	-

* Only available when specific object has a Notification Class configured

5.3.44 OxxUxx_RC Restriction_C (Binary Output Object Type)

Property Identifier	Property Datatype	Value	ASHRAE	IBOX
Object_Identifier	BACnetObjectIdentifier	(Binary Output, (xxx*100) + 3)	R	R
Object_Name	CharacterString	<i>OxxUxx_RC Restriction_C</i>	R	R
Object_Type	BACnetObjectType	BINARY_OUTPUT (4)	R	R
Present_Value	BACnetBinaryPV	INACTIVE (0) / ACTIVE (1)	W	W
Description	CharacterString	-	O	-
Device_Type	CharacterString	-	O	-
Status_Flags	BACnetStatusFlags	{FALSE, FALSE, FALSE, FALSE}	R	R
Event_State	BACnetEventState	STATE_NORMAL (0)	R	R
Reliability	BACnetReliability	NO_FAULT_DETECTED (0)	O	R
Out_Of_Service	BOOLEAN	FALSE	R	R
Polarity	BACnetPolarity	NORMAL (0)	R	R
Inactive_Text	CharacterString	<i>"No restriction"</i>	O	R
Active_Text	CharacterString	<i>"Restriction"</i>	O	R
Change_Of_State_Time	BACnetDatetime	-	O	R
Change_Of_State_Count	Unsigned	-	O	R
Time_Of_State_Count_Reset	BACnetDatetime	-	O	R
Elapsed_Active_Time	Unsigned	-	O	R
Time_Of_Active_Time_Reset	BACnetDatetime	-	O	R
Minimum_Off_Time	Unsigned32	-	O	-
Minimum_On_Time	Unsigned32	-	O	-
Priority_Array	BACnetPriorityArray	BACnetPriorityArray	R	R
Relinquish_Default	BACnetBinaryPV	INACTIVE (0)	R	R
Time_Delay	Unsigned	-	O	R*
Notification_Class	Unsigned	-	O	R*
Feedback_Value	BACnetBinaryPV	-	O	W
Event_Enable	BACnetEventTransitionBits	-	O	R*
Acked_Transitions	BACnetEventTransitionBits	-	O	R*
Notify_Type	BACnetNotifyType	-	O	R*
Event_Time_Stamps	BACnetArray[N] of BACnetTimeStamp	-	O	R*
Profile_Name	CharacterString	-	O	-

* Only available when specific object has a Notification Class configured

5.3.45 OxxUxx_Buzzer Sound (Binary Output Object Type)

Property Identifier	Property Datatype	Value	ASHRAE	IBOX
Object_Identifier	BACnetObjectIdentifier	(Binary Output, (xxx*100) + 4)	R	R
Object_Name	CharacterString	<i>OxxUxx_Buzzer Sound</i>	R	R
Object_Type	BACnetObjectType	BINARY_OUTPUT (4)	R	R
Present_Value	BACnetBinaryPV	INACTIVE (0) / ACTIVE (1)	W	W
Description	CharacterString	-	O	-
Device_Type	CharacterString	-	O	-
Status_Flags	BACnetStatusFlags	{FALSE, FALSE, FALSE, FALSE}	R	R
Event_State	BACnetEventState	STATE_NORMAL (0)	R	R
Reliability	BACnetReliability	NO_FAULT_DETECTED (0)	O	R
Out_Of_Service	BOOLEAN	FALSE	R	R
Polarity	BACnetPolarity	NORMAL (0)	R	R
Inactive_Text	CharacterString	<i>"Buzzer On"</i>	O	R
Active_Text	CharacterString	<i>"Buzzer Off"</i>	O	R
Change_Of_State_Time	BACnetDatetime	-	O	R
Change_Of_State_Count	Unsigned	-	O	R
Time_Of_State_Count_Reset	BACnetDatetime	-	O	R
Elapsed_Active_Time	Unsigned	-	O	R
Time_Of_Active_Time_Reset	BACnetDatetime	-	O	R
Minimum_Off_Time	Unsigned32	-	O	-
Minimum_On_Time	Unsigned32	-	O	-
Priority_Array	BACnetPriorityArray	BACnetPriorityArray	R	R
Relinquish_Default	BACnetBinaryPV	INACTIVE (0)	R	R
Time_Delay	Unsigned	-	O	R*
Notification_Class	Unsigned	-	O	R*
Feedback_Value	BACnetBinaryPV	-	O	W
Event_Enable	BACnetEventTransitionBits	-	O	R*
Acked_Transitions	BACnetEventTransitionBits	-	O	R*
Notify_Type	BACnetNotifyType	-	O	R*
Event_Time_Stamps	BACnetArray[N] of BACnetTimeStamp	-	O	R*
Profile_Name	CharacterString	-	O	-

* Only available when specific object has a Notification Class configured

5.3.46 OxxUxx_Unit type (Multistate Input Object Type)

Property Identifier	Property Datatype	Value	ASHRAE	IBOX
Object_Identifier	BACnetObjectIdentifier	(Multi-state Input, (xxx*100) + 3)	R	R
Object_Name	CharacterString	<i>OxxUxx_Unit type</i>	R	R
Object_Type	BACnetObjectType	MULTISTATE_INPUT (13)	R	R
Present_Value	Unsigned	x	R	R
Description	CharacterString	-	O	-
Device_Type	CharacterString	-	O	-
Status_Flags	BACnetStatusFlags	{FALSE, FALSE/TRUE, FALSE, FALSE}	R	R
Event_State	BACnetEventState	STATE_NORMAL (0)	R	R
Reliability	BACnetReliability	NO_FAULT_DETECTED (0), UNRELIABLE_OTHER (7)	O	R
Out_Of_Service	BOOLEAN	FALSE	R	R
Number_Of_States	Unsigned	9	R	R
State_Text	BACnetArray[N] of CharacterString	<i>Check Unit type table below</i>	O	R
Time_Delay	Unsigned	-	O	R*
Notification_Class	Unsigned	-	O	R*
Alarm_Values	List of Unsigned	-	O	R*
Fault_Values	List of Unsigned	-	O	R*
Event_Enable	BACnetEventTransitionBits	-	O	R*
Acked_Transitions	BACnetEventTransitionBits	-	O	R*
Notify_Type	BACnetNotifyType	-	O	R*
Event_Time_Stamps	BACnetArray[N] of BACnetTimeStamp	-	O	R*
Profile_Name	CharacterString	-	O	-

* Only available when specific object has a Notification Class configured

Unit type table (see next page)

Unit type table

Communication type interpretation is possible using the value in the following correspondence table.

Pesent_Value	Contents displayed in State_Text
1	Not Defined
2	IU
3	HE
4	HT
5	AHU
6	ERV
7	ERV+
8	EHS
9	CHILLER

5.3.47 OxxUxx_HotWater On/Off_S (Binary Input Object Type)

Property Identifier	Property Datatype	Value	ASHRAE	IBOX
Object_Identifier	BACnetObjectIdentifier	(Binary Input, (xxx*100) + 4)	R	R
Object_Name	CharacterString	OxxUxx_HotWater On/Off_S	R	R
Object_Type	BACnetObjectType	BINARY_INPUT (3)	R	R
Present_Value	BACnetBinaryPV	INACTIVE (0) / ACTIVE (1)	R	R
Description	CharacterString	-	O	-
Device_Type	CharacterString	-	O	-
Status_Flags	BACnetStatusFlags	{FALSE, FALSE/TRUE, FALSE, FALSE}	R	R
Event_State	BACnetEventState	STATE_NORMAL (0)	R	R
Reliability	BACnetReliability	NO_FAULT_DETECTED (0), UNRELIABLE_OTHER (7)	O	R
Out_Of_Service	BOOLEAN	FALSE	R	R
Polarity	BACnetPolarity	NORMAL (0)	R	R
Inactive_Text	CharacterString	"Off"	O	R
Active_Text	CharacterString	"On"	O	R
Change_Of_State_Time	BACnetDatetime	-	O	R
Change_Of_State_Count	Unsigned	-	O	R
Time_Of_State_Count_Reset	BACnetDatetime	-	O	R
Elapsed_Active_Time	Unsigned	-	O	R
Time_Of_Active_Time_Reset	BACnetDatetime	-	O	R
Time_Delay	Unsigned	-	O	R*
Notification_Class	Unsigned	-	O	R*
Alarm_Value	BACnetBinaryPV	-	O	R*
Event_Enable	BACnetEventTransitionBits	-	O	R*
Acked_Transitions	BACnetEventTransitionBits	-	O	R*
Notify_Type	BACnetNotifyType	-	O	R*
Event_Time_Stamps	BACnetArray[N] of BACnetTimeStamp	-	O	R*
Profile_Name	CharacterString	-	O	-

* Only available when specific object has a Notification Class configured

5.3.48 OxxUxx_HotWater On/Off_C (Binary Output Object Type)

Property Identifier	Property Datatype	Value	ASHRAE	IBOX
Object_Identifier	BACnetObjectIdentifier	(Binary Output, (xxx*100) + 5)	R	R
Object_Name	CharacterString	<i>OxxUxx_HotWater On/Off_C</i>	R	R
Object_Type	BACnetObjectType	BINARY_OUTPUT (4)	R	R
Present_Value	BACnetBinaryPV	INACTIVE (0) / ACTIVE (1)	W	W
Description	CharacterString	-	O	-
Device_Type	CharacterString	-	O	-
Status_Flags	BACnetStatusFlags	{FALSE, FALSE, FALSE, FALSE}	R	R
Event_State	BACnetEventState	STATE_NORMAL (0)	R	R
Reliability	BACnetReliability	NO_FAULT_DETECTED (0)	O	R
Out_Of_Service	BOOLEAN	FALSE	R	R
Polarity	BACnetPolarity	NORMAL (0)	R	R
Inactive_Text	CharacterString	<i>"Off"</i>	O	R
Active_Text	CharacterString	<i>"On"</i>	O	R
Change_Of_State_Time	BACnetDatetime	-	O	R
Change_Of_State_Count	Unsigned	-	O	R
Time_Of_State_Count_Reset	BACnetDatetime	-	O	R
Elapsed_Active_Time	Unsigned	-	O	R
Time_Of_Active_Time_Reset	BACnetDatetime	-	O	R
Minimum_Off_Time	Unsigned32	-	O	-
Minimum_On_Time	Unsigned32	-	O	-
Priority_Array	BACnetPriorityArray	BACnetPriorityArray	R	R
Relinquish_Default	BACnetBinaryPV	INACTIVE (0)	R	R
Time_Delay	Unsigned	-	O	R*
Notification_Class	Unsigned	-	O	R*
Feedback_Value	BACnetBinaryPV	-	O	W
Event_Enable	BACnetEventTransitionBits	-	O	R*
Acked_Transitions	BACnetEventTransitionBits	-	O	R*
Notify_Type	BACnetNotifyType	-	O	R*
Event_Time_Stamps	BACnetArray[N] of BACnetTimeStamp	-	O	R*
Profile_Name	CharacterString	-	O	-

* Only available when specific object has a Notification Class configured

5.3.49 OxxUxx_HotWater Mode HE/HT_S (Multistate Input Object Type)

Property Identifier	Property Datatype	Value	ASHRAE	IBOX
Object_Identifier	BACnetObjectIdentifier	(Multi-state Input, (xxx*100) + 4)	R	R
Object_Name	CharacterString	<i>OxxUxx_HotWater Mode HE/HT_S</i>	R	R
Object_Type	BACnetObjectType	MULTISTATE_INPUT (13)	R	R
Present_Value	Unsigned	x	R	R
Description	CharacterString	-	O	-
Device_Type	CharacterString	-	O	-
Status_Flags	BACnetStatusFlags	{FALSE, FALSE/TRUE, FALSE, FALSE}	R	R
Event_State	BACnetEventState	STATE_NORMAL (0)	R	R
Reliability	BACnetReliability	NO_FAULT_DETECTED (0), UNRELIABLE_OTHER (7)	O	R
Out_Of_Service	BOOLEAN	FALSE	R	R
Number_Of_States	Unsigned	3	R	R
State_Text	BACnetArray[N] of CharacterString	<i>Check HotWater Mode HE/HT table below</i>	O	R
Time_Delay	Unsigned	-	O	R*
Notification_Class	Unsigned	-	O	R*
Alarm_Values	List of Unsigned	-	O	R*
Fault_Values	List of Unsigned	-	O	R*
Event_Enable	BACnetEventTransitionBits	-	O	R*
Acked_Transitions	BACnetEventTransitionBits	-	O	R*
Notify_Type	BACnetNotifyType	-	O	R*
Event_Time_Stamps	BACnetArray[N] of BACnetTimeStamp	-	O	R*
Profile_Name	CharacterString	-	O	-

* Only available when specific object has a Notification Class configured

HotWater Mode HE/HT table

HotWater Mode HE/HT interpretation is possible using the value in the following correspondence table.

Present_Value	Contents displayed in State_Text
1	Eco
2	Standby
3	Power

5.3.50 OxxUxx_HotWater Mode EHS_S (Multistate Input Object Type)

Property Identifier	Property Datatype	Value	ASHRAE	IBOX
Object_Identifier	BACnetObjectIdentifier	(Multi-state Input, (xxx*100) + 4)	R	R
Object_Name	CharacterString	<i>OxxUxx_HotWater Mode EHS_S</i>	R	R
Object_Type	BACnetObjectType	MULTISTATE_INPUT (13)	R	R
Present_Value	Unsigned	x	R	R
Description	CharacterString	-	O	-
Device_Type	CharacterString	-	O	-
Status_Flags	BACnetStatusFlags	{FALSE, FALSE/TRUE, FALSE, FALSE}	R	R
Event_State	BACnetEventState	STATE_NORMAL (0)	R	R
Reliability	BACnetReliability	NO_FAULT_DETECTED (0), UNRELIABLE_OTHER (7)	O	R
Out_Of_Service	BOOLEAN	FALSE	R	R
Number_Of_States	Unsigned	4	R	R
State_Text	BACnetArray[N] of CharacterString	<i>Check HotWater Mode EHS table below</i>	O	R
Time_Delay	Unsigned	-	O	R*
Notification_Class	Unsigned	-	O	R*
Alarm_Values	List of Unsigned	-	O	R*
Fault_Values	List of Unsigned	-	O	R*
Event_Enable	BACnetEventTransitionBits	-	O	R*
Acked_Transitions	BACnetEventTransitionBits	-	O	R*
Notify_Type	BACnetNotifyType	-	O	R*
Event_Time_Stamps	BACnetArray[N] of BACnetTimeStamp	-	O	R*
Profile_Name	CharacterString	-	O	-

* Only available when specific object has a Notification Class configured

HotWater Mode EHS table

HotWater Mode EHS interpretation is possible using the value in the following correspondence table.

Present Value	Contents displayed in State_Text
1	Eco
2	Standby
3	Power
4	Force

5.3.51 OxxUxx_HotWater Mode HE/HT_C (Multistate Output Object Type)

Property Identifier	Property Datatype	Value	ASHRAE	IBOX
Object_Identifier	BACnetObjectIdentifier	(Multi-state Output, (xxx*100) + 2)	R	R
Object_Name	CharacterString	<i>OxxUxx_HotWater Mode HE/HT_C</i>	R	R
Object_Type	BACnetObjectType	MULTISTATE_OUTPUT (14)	R	R
Present_Value	Unsigned	x	W	W
Description	CharacterString	-	O	-
Device_Type	CharacterString	-	O	-
Status_Flags	BACnetStatusFlags	{FALSE, FALSE, FALSE, FALSE}	R	R
Event_State	BACnetEventState	STATE_NORMAL (0)	R	R
Reliability	BACnetReliability	NO_FAULT_DETECTED (0)	O	R
Out_Of_Service	BOOLEAN	FALSE	R	R
Number_Of_States	Unsigned	3	R	R
State_Text	BACnetArray[N] of CharacterString	<i>Check HotWater Mode HE/HT table below</i>	O	R
Priority_Array	BACnetPriorityArray	BACnetPriorityArray	R	R
Relinquish_Default	Unsigned	1	R	R
Time_Delay	Unsigned	-	O	R*
Notification_Class	Unsigned	-	O	R*
Feedback_Value	Unsigned	-	O	W
Event_Enable	BACnetEventTransitionBits	-	O	R*
Acked_Transitions	BACnetEventTransitionBits	-	O	R*
Notify_Type	BACnetNotifyType	-	O	R*
Event_Time_Stamps	BACnetArray[N] of BACnetTimeStamp	-	O	R*
Profile_Name	CharacterString	-	O	-

* Only available when specific object has a Notification Class configured

HotWater Mode HE/HT table

HotWater Mode HE/HT interpretation is possible using the value in the following correspondence table.

Present_Value	Contents displayed in State_Text
1	Eco
2	Standby
3	Power

5.3.52 OxxUxx_HotWater Mode EHS_C (Multistate Output Object Type)

Property Identifier	Property Datatype	Value	ASHRAE	IBOX
Object_Identifier	BACnetObjectIdentifier	(Multi-state Output, (xxx*100) + 2)	R	R
Object_Name	CharacterString	<i>OxxUxx_HotWater Mode EHS_C</i>	R	R
Object_Type	BACnetObjectType	MULTISTATE_OUTPUT (14)	R	R
Present_Value	Unsigned	x	W	W
Description	CharacterString	-	O	-
Device_Type	CharacterString	-	O	-
Status_Flags	BACnetStatusFlags	{FALSE, FALSE, FALSE, FALSE}	R	R
Event_State	BACnetEventState	STATE_NORMAL (0)	R	R
Reliability	BACnetReliability	NO_FAULT_DETECTED (0)	O	R
Out_Of_Service	BOOLEAN	FALSE	R	R
Number_Of_States	Unsigned	4	R	R
State_Text	BACnetArray[N] of CharacterString	<i>Check HotWater Mode EHS table below</i>	O	R
Priority_Array	BACnetPriorityArray	BACnetPriorityArray	R	R
Relinquish_Default	Unsigned	1	R	R
Time_Delay	Unsigned	-	O	R*
Notification_Class	Unsigned	-	O	R*
Feedback_Value	Unsigned	-	O	W
Event_Enable	BACnetEventTransitionBits	-	O	R*
Acked_Transitions	BACnetEventTransitionBits	-	O	R*
Notify_Type	BACnetNotifyType	-	O	R*
Event_Time_Stamps	BACnetArray[N] of BACnetTimeStamp	-	O	R*
Profile_Name	CharacterString	-	O	-

* Only available when specific object has a Notification Class configured

HotWater Mode EHS table

HotWater Mode EHS interpretation is possible using the value in the following correspondence table.

Present_Value	Contents displayed in State_Text
1	Eco
2	Standby
3	Power
4	Force

5.3.53 OxxUxx_HotWater Setpoint HE_S (Analog Input Object Type)

Property Identifier	Property Datatype	Value	ASHRAE	IBOX
Object_Identifier	BACnetObjectIdentifier	(Analog Input, (xxx*100) + 8)	R	R
Object_Name	CharacterString	<i>OxxUxx_HotWater Setpoint HE_S</i>	R	R
Object_Type	BACnetObjectType	ANALOG_INPUT (0)	R	R
Present_Value	REAL	x	R	R
Description	CharacterString	-	O	-
Device_Type	CharacterString	-	O	-
Status_Flags	BACnetStatusFlags	{FALSE, FALSE/TRUE, FALSE, FALSE}	R	R
Event_State	BACnetEventState	STATE_NORMAL (0)	R	R
Reliability	BACnetReliability	NO_FAULT_DETECTED (0), UNRELIABLE_OTHER (7)	O	R
Out_Of_Service	BOOLEAN	FALSE	R	R
Update_Interval	Unsigned	-	O	-
Units	BACnetEngineeringUnits	<i>degrees_Celsius</i>	R	R
Min_Pres_Value	REAL	-	O	-
Max_Pres_Value	REAL	-	O	-
Resolution	REAL	-	O	-
COV_Increment	REAL	0	O	R
Time_Delay	Unsigned	-	O	R*
Notification_Class	Unsigned	-	O	R*
High_Limit	REAL	-	O	R*
Low_Limit	REAL	-	O	R*
Deadband	REAL	-	O	R*
Limit_Enable	BACnetLimitEnable	-	O	R*
Event_Enable	BACnetEventTransitionBits	-	O	R*
Acked_Transitions	BACnetEventTransitionBits	-	O	R*
Notify_Type	BACnetNotifyType	-	O	R*
Event_Time_Stamps	BACnetArray[N] of BACnetTimeStamp	-	O	R*
Profile_Name	CharacterString	-	O	-

* Only available when specific object has a Notification Class configured

5.3.54 OxxUxx_HotWater Setpoint HT_S (Analog Input Object Type)

Property Identifier	Property Datatype	Value	ASHRAE	IBOX
Object_Identifier	BACnetObjectIdentifier	(Analog Input, (xxx*100) + 8)	R	R
Object_Name	CharacterString	<i>OxxUxx_HotWater Setpoint HT_S</i>	R	R
Object_Type	BACnetObjectType	ANALOG_INPUT (0)	R	R
Present_Value	REAL	x	R	R
Description	CharacterString	-	O	-
Device_Type	CharacterString	-	O	-
Status_Flags	BACnetStatusFlags	{FALSE, FALSE/TRUE, FALSE, FALSE}	R	R
Event_State	BACnetEventState	STATE_NORMAL (0)	R	R
Reliability	BACnetReliability	NO_FAULT_DETECTED (0), UNRELIABLE_OTHER (7)	O	R
Out_Of_Service	BOOLEAN	FALSE	R	R
Update_Interval	Unsigned	-	O	-
Units	BACnetEngineeringUnits	<i>degrees_Celsius</i>	R	R
Min_Pres_Value	REAL	-	O	-
Max_Pres_Value	REAL	-	O	-
Resolution	REAL	-	O	-
COV_Increment	REAL	0	O	R
Time_Delay	Unsigned	-	O	R*
Notification_Class	Unsigned	-	O	R*
High_Limit	REAL	-	O	R*
Low_Limit	REAL	-	O	R*
Deadband	REAL	-	O	R*
Limit_Enable	BACnetLimitEnable	-	O	R*
Event_Enable	BACnetEventTransitionBits	-	O	R*
Acked_Transitions	BACnetEventTransitionBits	-	O	R*
Notify_Type	BACnetNotifyType	-	O	R*
Event_Time_Stamps	BACnetArray[N] of BACnetTimeStamp	-	O	R*
Profile_Name	CharacterString	-	O	-

* Only available when specific object has a Notification Class configured

5.3.55 OxxUxx_HotWater Setpoint EHS_S (Analog Input Object Type)

Property Identifier	Property Datatype	Value	ASHRAE	IBOX
Object_Identifier	BACnetObjectIdentifier	(Analog Input, (xxx*100) + 8)	R	R
Object_Name	CharacterString	<i>OxxUxx_HotWater Setpoint EHS_S</i>	R	R
Object_Type	BACnetObjectType	ANALOG_INPUT (0)	R	R
Present_Value	REAL	x	R	R
Description	CharacterString	-	O	-
Device_Type	CharacterString	-	O	-
Status_Flags	BACnetStatusFlags	{FALSE, FALSE/TRUE, FALSE, FALSE}	R	R
Event_State	BACnetEventState	STATE_NORMAL (0)	R	R
Reliability	BACnetReliability	NO_FAULT_DETECTED (0), UNRELIABLE_OTHER (7)	O	R
Out_Of_Service	BOOLEAN	FALSE	R	R
Update_Interval	Unsigned	-	O	-
Units	BACnetEngineeringUnits	<i>degrees_Celsius</i>	R	R
Min_Pres_Value	REAL	-	O	-
Max_Pres_Value	REAL	-	O	-
Resolution	REAL	-	O	-
COV_Increment	REAL	0	O	R
Time_Delay	Unsigned	-	O	R*
Notification_Class	Unsigned	-	O	R*
High_Limit	REAL	-	O	R*
Low_Limit	REAL	-	O	R*
Deadband	REAL	-	O	R*
Limit_Enable	BACnetLimitEnable	-	O	R*
Event_Enable	BACnetEventTransitionBits	-	O	R*
Acked_Transitions	BACnetEventTransitionBits	-	O	R*
Notify_Type	BACnetNotifyType	-	O	R*
Event_Time_Stamps	BACnetArray[N] of BACnetTimeStamp	-	O	R*
Profile_Name	CharacterString	-	O	-

* Only available when specific object has a Notification Class configured

5.3.56 OxxUxx_HotWater Setpoint HE_C (Analog Output Object Type)

Property Identifier	Property Datatype	Value	ASHRAE	IBOX
Object_Identifier	BACnetObjectIdentifier	(Analog Output, (xxx*100) + 3)	R	R
Object_Name	CharacterString	<i>OxxUxx_HotWater Setpoint HE_C</i>	R	R
Object_Type	BACnetObjectType	ANALOG_OUTPUT (1)	R	R
Present_Value	REAL	x	W	W
Description	CharacterString	-	O	-
Device_Type	CharacterString	-	O	-
Status_Flags	BACnetStatusFlags	{FALSE, FALSE, FALSE, FALSE}	R	R
Event_State	BACnetEventState	STATE_NORMAL (0)	R	R
Reliability	BACnetReliability	NO_FAULT_DETECTED (0)	O	R
Out_Of_Service	BOOLEAN	FALSE	R	R
Update_Interval	Unsigned	-	O	-
Units	BACnetEngineeringUnits	<i>degrees_Celsius</i>	R	R
Min_Pres_Value	REAL	-	O	-
Max_Pres_Value	REAL	-	O	-
Resolution	REAL	-	O	-
COV_Increment	REAL	0	O	R
Priority_Array	BACnetPriorityArray	BACnetPriorityArray	R	R
Relinquish_Default	Unsigned	<i>Configurable through BACnet and Config Tool</i>	R	R
Time_Delay	Unsigned	-	O	R*
Notification_Class	Unsigned	-	O	R*
High_Limit	REAL	-	O	R*
Low_Limit	REAL	-	O	R*
Deadband	REAL	-	O	R*
Limit_Enable	BACnetLimitEnable	-	O	R*
Event_Enable	BACnetEventTransitionBits	-	O	R*
Acked_Transitions	BACnetEventTransitionBits	-	O	R*
Notify_Type	BACnetNotifyType	-	O	R*
Event_Time_Stamps	BACnetArray[N] of BACnetTimeStamp	-	O	R*
Profile_Name	CharacterString	-	O	-

* Only available when specific object has a Notification Class configured

5.3.57 OxxUxx_HotWater Setpoint EHS_C (Analog Output Object Type)

Property Identifier	Property Datatype	Value	ASHRAE	IBOX
Object_Identifier	BACnetObjectIdentifier	(Analog Output, (xxx*100) + 3)	R	R
Object_Name	CharacterString	<i>OxxUxx_HotWater Setpoint EHS_C</i>	R	R
Object_Type	BACnetObjectType	ANALOG_OUTPUT (1)	R	R
Present_Value	REAL	x	W	W
Description	CharacterString	-	O	-
Device_Type	CharacterString	-	O	-
Status_Flags	BACnetStatusFlags	{FALSE, FALSE, FALSE, FALSE}	R	R
Event_State	BACnetEventState	STATE_NORMAL (0)	R	R
Reliability	BACnetReliability	NO_FAULT_DETECTED (0)	O	R
Out_Of_Service	BOOLEAN	FALSE	R	R
Update_Interval	Unsigned	-	O	-
Units	BACnetEngineeringUnits	<i>degrees_Celsius</i>	R	R
Min_Pres_Value	REAL	-	O	-
Max_Pres_Value	REAL	-	O	-
Resolution	REAL	-	O	-
COV_Increment	REAL	0	O	R
Priority_Array	BACnetPriorityArray	BACnetPriorityArray	R	R
Relinquish_Default	Unsigned	<i>Configurable through BACnet and Config Tool</i>	R	R
Time_Delay	Unsigned	-	O	R*
Notification_Class	Unsigned	-	O	R*
High_Limit	REAL	-	O	R*
Low_Limit	REAL	-	O	R*
Deadband	REAL	-	O	R*
Limit_Enable	BACnetLimitEnable	-	O	R*
Event_Enable	BACnetEventTransitionBits	-	O	R*
Acked_Transitions	BACnetEventTransitionBits	-	O	R*
Notify_Type	BACnetNotifyType	-	O	R*
Event_Time_Stamps	BACnetArray[N] of BACnetTimeStamp	-	O	R*
Profile_Name	CharacterString	-	O	-

* Only available when specific object has a Notification Class configured

5.3.58 OxxUxx_HotWater Current Temp. (Analog Input Object Type)

Property Identifier	Property Datatype	Value	ASHRAE	IBOX
Object_Identifier	BACnetObjectIdentifier	(Analog Input, (xxx*100) + 9)	R	R
Object_Name	CharacterString	<i>OxxUxx_HotWater Current Temp.</i>	R	R
Object_Type	BACnetObjectType	ANALOG_INPUT (0)	R	R
Present_Value	REAL	x	R	R
Description	CharacterString	-	O	-
Device_Type	CharacterString	-	O	-
Status_Flags	BACnetStatusFlags	{FALSE, FALSE/TRUE, FALSE, FALSE}	R	R
Event_State	BACnetEventState	STATE_NORMAL (0)	R	R
Reliability	BACnetReliability	NO_FAULT_DETECTED (0), UNRELIABLE_OTHER (7)	O	R
Out_Of_Service	BOOLEAN	FALSE	R	R
Update_Interval	Unsigned	-	O	-
Units	BACnetEngineeringUnits	<i>degrees_Celsius</i>	R	R
Min_Pres_Value	REAL	-	O	-
Max_Pres_Value	REAL	-	O	-
Resolution	REAL	-	O	-
COV_Increment	REAL	0	O	R
Time_Delay	Unsigned	-	O	R*
Notification_Class	Unsigned	-	O	R*
High_Limit	REAL	-	O	R*
Low_Limit	REAL	-	O	R*
Deadband	REAL	-	O	R*
Limit_Enable	BACnetLimitEnable	-	O	R*
Event_Enable	BACnetEventTransitionBits	-	O	R*
Acked_Transitions	BACnetEventTransitionBits	-	O	R*
Notify_Type	BACnetNotifyType	-	O	R*
Event_Time_Stamps	BACnetArray[N] of BACnetTimeStamp	-	O	R*
Profile_Name	CharacterString	-	O	-

* Only available when specific object has a Notification Class configured

5.3.59 OxxUxx_WaterIn Temperature. (Analog Input Object Type)

Property Identifier	Property Datatype	Value	ASHRAE	IBOX
Object_Identifier	BACnetObjectIdentifier	(Analog Input, (xxx*100) + 10)	R	R
Object_Name	CharacterString	<i>OxxUxx_WaterIn Temperature</i>	R	R
Object_Type	BACnetObjectType	ANALOG_INPUT (0)	R	R
Present_Value	REAL	x	R	R
Description	CharacterString	-	O	-
Device_Type	CharacterString	-	O	-
Status_Flags	BACnetStatusFlags	{FALSE, FALSE/TRUE, FALSE, FALSE}	R	R
Event_State	BACnetEventState	STATE_NORMAL (0)	R	R
Reliability	BACnetReliability	NO_FAULT_DETECTED (0), UNRELIABLE_OTHER (7)	O	R
Out_Of_Service	BOOLEAN	FALSE	R	R
Update_Interval	Unsigned	-	O	-
Units	BACnetEngineeringUnits	<i>degrees_Celsius</i>	R	R
Min_Pres_Value	REAL	-	O	-
Max_Pres_Value	REAL	-	O	-
Resolution	REAL	-	O	-
COV_Increment	REAL	0	O	R
Time_Delay	Unsigned	-	O	R*
Notification_Class	Unsigned	-	O	R*
High_Limit	REAL	-	O	R*
Low_Limit	REAL	-	O	R*
Deadband	REAL	-	O	R*
Limit_Enable	BACnetLimitEnable	-	O	R*
Event_Enable	BACnetEventTransitionBits	-	O	R*
Acked_Transitions	BACnetEventTransitionBits	-	O	R*
Notify_Type	BACnetNotifyType	-	O	R*
Event_Time_Stamps	BACnetArray[N] of BACnetTimeStamp	-	O	R*
Profile_Name	CharacterString	-	O	-

* Only available when specific object has a Notification Class configured

5.3.60 OxxUxx_WaterOut Temperature. (Analog Input Object Type)

Property Identifier	Property Datatype	Value	ASHRAE	IBOX
Object_Identifier	BACnetObjectIdentifier	(Analog Input, (xxx*100) + 11)	R	R
Object_Name	CharacterString	<i>OxxUxx_WaterOut Temperature</i>	R	R
Object_Type	BACnetObjectType	ANALOG_INPUT (0)	R	R
Present_Value	REAL	x	R	R
Description	CharacterString	-	O	-
Device_Type	CharacterString	-	O	-
Status_Flags	BACnetStatusFlags	{FALSE, FALSE/TRUE, FALSE, FALSE}	R	R
Event_State	BACnetEventState	STATE_NORMAL (0)	R	R
Reliability	BACnetReliability	NO_FAULT_DETECTED (0), UNRELIABLE_OTHER (7)	O	R
Out_Of_Service	BOOLEAN	FALSE	R	R
Update_Interval	Unsigned	-	O	-
Units	BACnetEngineeringUnits	<i>degrees_Celsius</i>	R	R
Min_Pres_Value	REAL	-	O	-
Max_Pres_Value	REAL	-	O	-
Resolution	REAL	-	O	-
COV_Increment	REAL	0	O	R
Time_Delay	Unsigned	-	O	R*
Notification_Class	Unsigned	-	O	R*
High_Limit	REAL	-	O	R*
Low_Limit	REAL	-	O	R*
Deadband	REAL	-	O	R*
Limit_Enable	BACnetLimitEnable	-	O	R*
Event_Enable	BACnetEventTransitionBits	-	O	R*
Acked_Transitions	BACnetEventTransitionBits	-	O	R*
Notify_Type	BACnetNotifyType	-	O	R*
Event_Time_Stamps	BACnetArray[N] of BACnetTimeStamp	-	O	R*
Profile_Name	CharacterString	-	O	-

* Only available when specific object has a Notification Class configured

5.3.61 OxxUxx_WaterOut Setpoint HE_S. (Analog Input Object Type)

Property Identifier	Property Datatype	Value	ASHRAE	IBOX
Object_Identifier	BACnetObjectIdentifier	(Analog Input, (xxx*100) + 12)	R	R
Object_Name	CharacterString	<i>OxxUxx_WaterOut Setpoint HE_S</i>	R	R
Object_Type	BACnetObjectType	ANALOG_INPUT (0)	R	R
Present_Value	REAL	x	R	R
Description	CharacterString	-	O	-
Device_Type	CharacterString	-	O	-
Status_Flags	BACnetStatusFlags	{FALSE, FALSE/TRUE, FALSE, FALSE}	R	R
Event_State	BACnetEventState	STATE_NORMAL (0)	R	R
Reliability	BACnetReliability	NO_FAULT_DETECTED (0), UNRELIABLE_OTHER (7)	O	R
Out_Of_Service	BOOLEAN	FALSE	R	R
Update_Interval	Unsigned	-	O	-
Units	BACnetEngineeringUnits	<i>degrees_Celsius</i>	R	R
Min_Pres_Value	REAL	-	O	-
Max_Pres_Value	REAL	-	O	-
Resolution	REAL	-	O	-
COV_Increment	REAL	0	O	R
Time_Delay	Unsigned	-	O	R*
Notification_Class	Unsigned	-	O	R*
High_Limit	REAL	-	O	R*
Low_Limit	REAL	-	O	R*
Deadband	REAL	-	O	R*
Limit_Enable	BACnetLimitEnable	-	O	R*
Event_Enable	BACnetEventTransitionBits	-	O	R*
Acked_Transitions	BACnetEventTransitionBits	-	O	R*
Notify_Type	BACnetNotifyType	-	O	R*
Event_Time_Stamps	BACnetArray[N] of BACnetTimeStamp	-	O	R*
Profile_Name	CharacterString	-	O	-

* Only available when specific object has a Notification Class configured

5.3.62 OxxUxx_WaterOut Setpoint HT_S. (Analog Input Object Type)

Property Identifier	Property Datatype	Value	ASHRAE	IBOX
Object_Identifier	BACnetObjectIdentifier	(Analog Input, (xxx*100) + 12)	R	R
Object_Name	CharacterString	<i>OxxUxx_WaterOut Setpoint HT_S</i>	R	R
Object_Type	BACnetObjectType	ANALOG_INPUT (0)	R	R
Present_Value	REAL	x	R	R
Description	CharacterString	-	O	-
Device_Type	CharacterString	-	O	-
Status_Flags	BACnetStatusFlags	{FALSE, FALSE/TRUE, FALSE, FALSE}	R	R
Event_State	BACnetEventState	STATE_NORMAL (0)	R	R
Reliability	BACnetReliability	NO_FAULT_DETECTED (0), UNRELIABLE_OTHER (7)	O	R
Out_Of_Service	BOOLEAN	FALSE	R	R
Update_Interval	Unsigned	-	O	-
Units	BACnetEngineeringUnits	<i>degrees_Celsius</i>	R	R
Min_Pres_Value	REAL	-	O	-
Max_Pres_Value	REAL	-	O	-
Resolution	REAL	-	O	-
COV_Increment	REAL	0	O	R
Time_Delay	Unsigned	-	O	R*
Notification_Class	Unsigned	-	O	R*
High_Limit	REAL	-	O	R*
Low_Limit	REAL	-	O	R*
Deadband	REAL	-	O	R*
Limit_Enable	BACnetLimitEnable	-	O	R*
Event_Enable	BACnetEventTransitionBits	-	O	R*
Acked_Transitions	BACnetEventTransitionBits	-	O	R*
Notify_Type	BACnetNotifyType	-	O	R*
Event_Time_Stamps	BACnetArray[N] of BACnetTimeStamp	-	O	R*
Profile_Name	CharacterString	-	O	-

* Only available when specific object has a Notification Class configured

5.3.63 OxxUxx_WaterOut Setpoint EHS_S. (Analog Input Object Type)

Property Identifier	Property Datatype	Value	ASHRAE	IBOX
Object_Identifier	BACnetObjectIdentifier	(Analog Input, (xxx*100) + 12)	R	R
Object_Name	CharacterString	<i>OxxUxx_WaterOut Setpoint EHS_S</i>	R	R
Object_Type	BACnetObjectType	ANALOG_INPUT (0)	R	R
Present_Value	REAL	x	R	R
Description	CharacterString	-	O	-
Device_Type	CharacterString	-	O	-
Status_Flags	BACnetStatusFlags	{FALSE, FALSE/TRUE, FALSE, FALSE}	R	R
Event_State	BACnetEventState	STATE_NORMAL (0)	R	R
Reliability	BACnetReliability	NO_FAULT_DETECTED (0), UNRELIABLE_OTHER (7)	O	R
Out_Of_Service	BOOLEAN	FALSE	R	R
Update_Interval	Unsigned	-	O	-
Units	BACnetEngineeringUnits	<i>degrees_Celsius</i>	R	R
Min_Pres_Value	REAL	-	O	-
Max_Pres_Value	REAL	-	O	-
Resolution	REAL	-	O	-
COV_Increment	REAL	0	O	R
Time_Delay	Unsigned	-	O	R*
Notification_Class	Unsigned	-	O	R*
High_Limit	REAL	-	O	R*
Low_Limit	REAL	-	O	R*
Deadband	REAL	-	O	R*
Limit_Enable	BACnetLimitEnable	-	O	R*
Event_Enable	BACnetEventTransitionBits	-	O	R*
Acked_Transitions	BACnetEventTransitionBits	-	O	R*
Notify_Type	BACnetNotifyType	-	O	R*
Event_Time_Stamps	BACnetArray[N] of BACnetTimeStamp	-	O	R*
Profile_Name	CharacterString	-	O	-

* Only available when specific object has a Notification Class configured

5.3.64 OxxUxx_WaterOut Setpoint CHILL_S (Analog Input Object Type)

Property Identifier	Property Datatype	Value	ASHRAE	IBOX
Object_Identifier	BACnetObjectIdentifier	(Analog Input, (xxx*100) + 12)	R	R
Object_Name	CharacterString	<i>OxxUxx_WaterOut Setpoint CHILL_S</i>	R	R
Object_Type	BACnetObjectType	ANALOG_INPUT (0)	R	R
Present_Value	REAL	x	R	R
Description	CharacterString	-	O	-
Device_Type	CharacterString	-	O	-
Status_Flags	BACnetStatusFlags	{FALSE, FALSE/TRUE, FALSE, FALSE}	R	R
Event_State	BACnetEventState	STATE_NORMAL (0)	R	R
Reliability	BACnetReliability	NO_FAULT_DETECTED (0), UNRELIABLE_OTHER (7)	O	R
Out_Of_Service	BOOLEAN	FALSE	R	R
Update_Interval	Unsigned	-	O	-
Units	BACnetEngineeringUnits	<i>degrees_Celsius</i>	R	R
Min_Pres_Value	REAL	-	O	-
Max_Pres_Value	REAL	-	O	-
Resolution	REAL	-	O	-
COV_Increment	REAL	0	O	R
Time_Delay	Unsigned	-	O	R*
Notification_Class	Unsigned	-	O	R*
High_Limit	REAL	-	O	R*
Low_Limit	REAL	-	O	R*
Deadband	REAL	-	O	R*
Limit_Enable	BACnetLimitEnable	-	O	R*
Event_Enable	BACnetEventTransitionBits	-	O	R*
Acked_Transitions	BACnetEventTransitionBits	-	O	R*
Notify_Type	BACnetNotifyType	-	O	R*
Event_Time_Stamps	BACnetArray[N] of BACnetTimeStamp	-	O	R*
Profile_Name	CharacterString	-	O	-

* Only available when specific object has a Notification Class configured

5.3.65 OxxUxx_WaterOut Setpoint HE_C (Analog Output Object Type)

Property Identifier	Property Datatype	Value	ASHRAE	IBOX
Object_Identifier	BACnetObjectIdentifier	(Analog Output, (xxx*100) + 4)	R	R
Object_Name	CharacterString	<i>OxxUxx_WaterOut Setpoint HE_C</i>	R	R
Object_Type	BACnetObjectType	ANALOG_OUTPUT (1)	R	R
Present_Value	REAL	x	W	W
Description	CharacterString	-	O	-
Device_Type	CharacterString	-	O	-
Status_Flags	BACnetStatusFlags	{FALSE, FALSE, FALSE, FALSE}	R	R
Event_State	BACnetEventState	STATE_NORMAL (0)	R	R
Reliability	BACnetReliability	NO_FAULT_DETECTED (0)	O	R
Out_Of_Service	BOOLEAN	FALSE	R	R
Update_Interval	Unsigned	-	O	-
Units	BACnetEngineeringUnits	<i>degrees_Celsius</i>	R	R
Min_Pres_Value	REAL	-	O	-
Max_Pres_Value	REAL	-	O	-
Resolution	REAL	-	O	-
COV_Increment	REAL	0	O	R
Priority_Array	BACnetPriorityArray	BACnetPriorityArray	R	R
Relinquish_Default	Unsigned	<i>Configurable through BACnet and Config Tool</i>	R	R
Time_Delay	Unsigned	-	O	R*
Notification_Class	Unsigned	-	O	R*
High_Limit	REAL	-	O	R*
Low_Limit	REAL	-	O	R*
Deadband	REAL	-	O	R*
Limit_Enable	BACnetLimitEnable	-	O	R*
Event_Enable	BACnetEventTransitionBits	-	O	R*
Acked_Transitions	BACnetEventTransitionBits	-	O	R*
Notify_Type	BACnetNotifyType	-	O	R*
Event_Time_Stamps	BACnetArray[N] of BACnetTimeStamp	-	O	R*
Profile_Name	CharacterString	-	O	-

* Only available when specific object has a Notification Class configured

5.3.66 OxxUxx_WaterOut Setpoint HT_C (Analog Output Object Type)

Property Identifier	Property Datatype	Value	ASHRAE	IBOX
Object_Identifier	BACnetObjectIdentifier	(Analog Output, (xxx*100) + 4)	R	R
Object_Name	CharacterString	<i>OxxUxx_WaterOut Setpoint HT_C</i>	R	R
Object_Type	BACnetObjectType	ANALOG_OUTPUT (1)	R	R
Present_Value	REAL	x	W	W
Description	CharacterString	-	O	-
Device_Type	CharacterString	-	O	-
Status_Flags	BACnetStatusFlags	{FALSE, FALSE, FALSE, FALSE}	R	R
Event_State	BACnetEventState	STATE_NORMAL (0)	R	R
Reliability	BACnetReliability	NO_FAULT_DETECTED (0)	O	R
Out_Of_Service	BOOLEAN	FALSE	R	R
Update_Interval	Unsigned	-	O	-
Units	BACnetEngineeringUnits	<i>degrees_Celsius</i>	R	R
Min_Pres_Value	REAL	-	O	-
Max_Pres_Value	REAL	-	O	-
Resolution	REAL	-	O	-
COV_Increment	REAL	0	O	R
Priority_Array	BACnetPriorityArray	BACnetPriorityArray	R	R
Relinquish_Default	Unsigned	<i>Configurable through BACnet and Config Tool</i>	R	R
Time_Delay	Unsigned	-	O	R*
Notification_Class	Unsigned	-	O	R*
High_Limit	REAL	-	O	R*
Low_Limit	REAL	-	O	R*
Deadband	REAL	-	O	R*
Limit_Enable	BACnetLimitEnable	-	O	R*
Event_Enable	BACnetEventTransitionBits	-	O	R*
Acked_Transitions	BACnetEventTransitionBits	-	O	R*
Notify_Type	BACnetNotifyType	-	O	R*
Event_Time_Stamps	BACnetArray[N] of BACnetTimeStamp	-	O	R*
Profile_Name	CharacterString	-	O	-

* Only available when specific object has a Notification Class configured

5.3.67 OxxUxx_WaterOut Setpoint EHS_C (Analog Output Object Type)

Property Identifier	Property Datatype	Value	ASHRAE	IBOX
Object_Identifier	BACnetObjectIdentifier	(Analog Output, (xxx*100) + 4)	R	R
Object_Name	CharacterString	<i>OxxUxx_WaterOut Setpoint EHS_C</i>	R	R
Object_Type	BACnetObjectType	ANALOG_OUTPUT (1)	R	R
Present_Value	REAL	x	W	W
Description	CharacterString	-	O	-
Device_Type	CharacterString	-	O	-
Status_Flags	BACnetStatusFlags	{FALSE, FALSE, FALSE, FALSE}	R	R
Event_State	BACnetEventState	STATE_NORMAL (0)	R	R
Reliability	BACnetReliability	NO_FAULT_DETECTED (0)	O	R
Out_Of_Service	BOOLEAN	FALSE	R	R
Update_Interval	Unsigned	-	O	-
Units	BACnetEngineeringUnits	<i>degrees_Celsius</i>	R	R
Min_Pres_Value	REAL	-	O	-
Max_Pres_Value	REAL	-	O	-
Resolution	REAL	-	O	-
COV_Increment	REAL	0	O	R
Priority_Array	BACnetPriorityArray	BACnetPriorityArray	R	R
Relinquish_Default	Unsigned	<i>Configurable through BACnet and Config Tool</i>	R	R
Time_Delay	Unsigned	-	O	R*
Notification_Class	Unsigned	-	O	R*
High_Limit	REAL	-	O	R*
Low_Limit	REAL	-	O	R*
Deadband	REAL	-	O	R*
Limit_Enable	BACnetLimitEnable	-	O	R*
Event_Enable	BACnetEventTransitionBits	-	O	R*
Acked_Transitions	BACnetEventTransitionBits	-	O	R*
Notify_Type	BACnetNotifyType	-	O	R*
Event_Time_Stamps	BACnetArray[N] of BACnetTimeStamp	-	O	R*
Profile_Name	CharacterString	-	O	-

* Only available when specific object has a Notification Class configured

5.3.68 OxxUxx_WaterOut Setpoint CHILL_C (Analog Output Object Type)

Property Identifier	Property Datatype	Value	ASHRAE	IBOX
Object_Identifier	BACnetObjectIdentifier	(Analog Output, (xxx*100) + 4)	R	R
Object_Name	CharacterString	<i>OxxUxx_WaterOut Setpoint CHILL_C</i>	R	R
Object_Type	BACnetObjectType	ANALOG_OUTPUT (1)	R	R
Present_Value	REAL	x	W	W
Description	CharacterString	-	O	-
Device_Type	CharacterString	-	O	-
Status_Flags	BACnetStatusFlags	{FALSE, FALSE, FALSE, FALSE}	R	R
Event_State	BACnetEventState	STATE_NORMAL (0)	R	R
Reliability	BACnetReliability	NO_FAULT_DETECTED (0)	O	R
Out_Of_Service	BOOLEAN	FALSE	R	R
Update_Interval	Unsigned	-	O	-
Units	BACnetEngineeringUnits	<i>degrees_Celsius</i>	R	R
Min_Pres_Value	REAL	-	O	-
Max_Pres_Value	REAL	-	O	-
Resolution	REAL	-	O	-
COV_Increment	REAL	0	O	R
Priority_Array	BACnetPriorityArray	BACnetPriorityArray	R	R
Relinquish_Default	Unsigned	<i>Configurable through BACnet and Config Tool</i>	R	R
Time_Delay	Unsigned	-	O	R*
Notification_Class	Unsigned	-	O	R*
High_Limit	REAL	-	O	R*
Low_Limit	REAL	-	O	R*
Deadband	REAL	-	O	R*
Limit_Enable	BACnetLimitEnable	-	O	R*
Event_Enable	BACnetEventTransitionBits	-	O	R*
Acked_Transitions	BACnetEventTransitionBits	-	O	R*
Notify_Type	BACnetNotifyType	-	O	R*
Event_Time_Stamps	BACnetArray[N] of BACnetTimeStamp	-	O	R*
Profile_Name	CharacterString	-	O	-

* Only available when specific object has a Notification Class configured

5.3.69 OxxUxx_WaterOut Average Temp. (Analog Input Object Type)

Property Identifier	Property Datatype	Value	ASHRAE	IBOX
Object_Identifier	BACnetObjectIdentifier	(Analog Input, (xxx*100) + 13)	R	R
Object_Name	CharacterString	<i>OxxUxx_WaterOut Average Temp.</i>	R	R
Object_Type	BACnetObjectType	ANALOG_INPUT (0)	R	R
Present_Value	REAL	x	R	R
Description	CharacterString	-	O	-
Device_Type	CharacterString	-	O	-
Status_Flags	BACnetStatusFlags	{FALSE, FALSE/TRUE, FALSE, FALSE}	R	R
Event_State	BACnetEventState	STATE_NORMAL (0)	R	R
Reliability	BACnetReliability	NO_FAULT_DETECTED (0), UNRELIABLE_OTHER (7)	O	R
Out_Of_Service	BOOLEAN	FALSE	R	R
Update_Interval	Unsigned	-	O	-
Units	BACnetEngineeringUnits	<i>degrees_Celsius</i>	R	R
Min_Pres_Value	REAL	-	O	-
Max_Pres_Value	REAL	-	O	-
Resolution	REAL	-	O	-
COV_Increment	REAL	0	O	R
Time_Delay	Unsigned	-	O	R*
Notification_Class	Unsigned	-	O	R*
High_Limit	REAL	-	O	R*
Low_Limit	REAL	-	O	R*
Deadband	REAL	-	O	R*
Limit_Enable	BACnetLimitEnable	-	O	R*
Event_Enable	BACnetEventTransitionBits	-	O	R*
Acked_Transitions	BACnetEventTransitionBits	-	O	R*
Notify_Type	BACnetNotifyType	-	O	R*
Event_Time_Stamps	BACnetArray[N] of BACnetTimeStamp	-	O	R*
Profile_Name	CharacterString	-	O	-

* Only available when specific object has a Notification Class configured

5.3.70 OxxUxx_Vent. On/Off_S (Binary Input Object Type)

Property Identifier	Property Datatype	Value	ASHRAE	IBOX
Object_Identifier	BACnetObjectIdentifier	(Binary Input, (xxx*100) + 5)	R	R
Object_Name	CharacterString	OxxUxx_Vent. On/Off_S	R	R
Object_Type	BACnetObjectType	BINARY_INPUT (3)	R	R
Present_Value	BACnetBinaryPV	INACTIVE (0) / ACTIVE (1)	R	R
Description	CharacterString	-	O	-
Device_Type	CharacterString	-	O	-
Status_Flags	BACnetStatusFlags	{FALSE, FALSE/TRUE, FALSE, FALSE}	R	R
Event_State	BACnetEventState	STATE_NORMAL (0)	R	R
Reliability	BACnetReliability	NO_FAULT_DETECTED (0), UNRELIABLE_OTHER (7)	O	R
Out_Of_Service	BOOLEAN	FALSE	R	R
Polarity	BACnetPolarity	NORMAL (0)	R	R
Inactive_Text	CharacterString	"Off"	O	R
Active_Text	CharacterString	"On"	O	R
Change_Of_State_Time	BACnetDatetime	-	O	R
Change_Of_State_Count	Unsigned	-	O	R
Time_Of_State_Count_Reset	BACnetDatetime	-	O	R
Elapsed_Active_Time	Unsigned	-	O	R
Time_Of_Active_Time_Reset	BACnetDatetime	-	O	R
Time_Delay	Unsigned	-	O	R*
Notification_Class	Unsigned	-	O	R*
Alarm_Value	BACnetBinaryPV	-	O	R*
Event_Enable	BACnetEventTransitionBits	-	O	R*
Acked_Transitions	BACnetEventTransitionBits	-	O	R*
Notify_Type	BACnetNotifyType	-	O	R*
Event_Time_Stamps	BACnetArray[N] of BACnetTimeStamp	-	O	R*
Profile_Name	CharacterString	-	O	-

* Only available when specific object has a Notification Class configured

5.3.71 OxxUxx_HotWater On/Off_C (Binary Output Object Type)

Property Identifier	Property Datatype	Value	ASHRAE	IBOX
Object_Identifier	BACnetObjectIdentifier	(Binary Output, (xxx*100) + 6)	R	R
Object_Name	CharacterString	<i>OxxUxx_HotWater On/Off_C</i>	R	R
Object_Type	BACnetObjectType	BINARY_OUTPUT (4)	R	R
Present_Value	BACnetBinaryPV	INACTIVE (0) / ACTIVE (1)	W	W
Description	CharacterString	-	O	-
Device_Type	CharacterString	-	O	-
Status_Flags	BACnetStatusFlags	{FALSE, FALSE, FALSE, FALSE}	R	R
Event_State	BACnetEventState	STATE_NORMAL (0)	R	R
Reliability	BACnetReliability	NO_FAULT_DETECTED (0)	O	R
Out_Of_Service	BOOLEAN	FALSE	R	R
Polarity	BACnetPolarity	NORMAL (0)	R	R
Inactive_Text	CharacterString	<i>"Off"</i>	O	R
Active_Text	CharacterString	<i>"On"</i>	O	R
Change_Of_State_Time	BACnetDatetime	-	O	R
Change_Of_State_Count	Unsigned	-	O	R
Time_Of_State_Count_Reset	BACnetDatetime	-	O	R
Elapsed_Active_Time	Unsigned	-	O	R
Time_Of_Active_Time_Reset	BACnetDatetime	-	O	R
Minimum_Off_Time	Unsigned32	-	O	-
Minimum_On_Time	Unsigned32	-	O	-
Priority_Array	BACnetPriorityArray	BACnetPriorityArray	R	R
Relinquish_Default	BACnetBinaryPV	INACTIVE (0)	R	R
Time_Delay	Unsigned	-	O	R*
Notification_Class	Unsigned	-	O	R*
Feedback_Value	BACnetBinaryPV	-	O	W
Event_Enable	BACnetEventTransitionBits	-	O	R*
Acked_Transitions	BACnetEventTransitionBits	-	O	R*
Notify_Type	BACnetNotifyType	-	O	R*
Event_Time_Stamps	BACnetArray[N] of BACnetTimeStamp	-	O	R*
Profile_Name	CharacterString	-	O	-

* Only available when specific object has a Notification Class configured

5.3.72 OxxUxx_Vent. Mode_S (Multistate Input Object Type)

Property Identifier	Property Datatype	Value	ASHRAE	IBOX
Object_Identifier	BACnetObjectIdentifier	(Multi-state Input, (xxx*100) + 5)	R	R
Object_Name	CharacterString	<i>OxxUxx_Vent. Mode_S</i>	R	R
Object_Type	BACnetObjectType	MULTISTATE_INPUT (13)	R	R
Present_Value	Unsigned	x	R	R
Description	CharacterString	-	O	-
Device_Type	CharacterString	-	O	-
Status_Flags	BACnetStatusFlags	{FALSE, FALSE/TRUE, FALSE, FALSE}	R	R
Event_State	BACnetEventState	STATE_NORMAL (0)	R	R
Reliability	BACnetReliability	NO_FAULT_DETECTED (0), UNRELIABLE_OTHER (7)	O	R
Out_Of_Service	BOOLEAN	FALSE	R	R
Number_Of_States	Unsigned	4	R	R
State_Text	BACnetArray[N] of CharacterString	<i>Check Vent Mode table below</i>	O	R
Time_Delay	Unsigned	-	O	R*
Notification_Class	Unsigned	-	O	R*
Alarm_Values	List of Unsigned	-	O	R*
Fault_Values	List of Unsigned	-	O	R*
Event_Enable	BACnetEventTransitionBits	-	O	R*
Acked_Transitions	BACnetEventTransitionBits	-	O	R*
Notify_Type	BACnetNotifyType	-	O	R*
Event_Time_Stamps	BACnetArray[N] of BACnetTimeStamp	-	O	R*
Profile_Name	CharacterString	-	O	-

* Only available when specific object has a Notification Class configured

Vent Mode table

Vent Mode interpretation is possible using the value in the following correspondence table.

Present_Value	Contents displayed in State_Text
1	Bypass
2	HeatEx
3	Sleep
4	Auto

5.3.73 OxxUxx_Vent. Mode_C (Multistate Output Object Type)

Property Identifier	Property Datatype	Value	ASHRAE	IBOX
Object_Identifier	BACnetObjectIdentifier	(Multi-state Output, (xxx*100) + 3)	R	R
Object_Name	CharacterString	<i>OxxUxx_Vent. Mode_C</i>	R	R
Object_Type	BACnetObjectType	MULTISTATE_OUTPUT (14)	R	R
Present_Value	Unsigned	x	W	W
Description	CharacterString	-	O	-
Device_Type	CharacterString	-	O	-
Status_Flags	BACnetStatusFlags	{FALSE, FALSE, FALSE, FALSE}	R	R
Event_State	BACnetEventState	STATE_NORMAL (0)	R	R
Reliability	BACnetReliability	NO_FAULT_DETECTED (0)	O	R
Out_Of_Service	BOOLEAN	FALSE	R	R
Number_Of_States	Unsigned	4	R	R
State_Text	BACnetArray[N] of CharacterString	<i>Check Vent Mode table below</i>	O	R
Priority_Array	BACnetPriorityArray	BACnetPriorityArray	R	R
Relinquish_Default	Unsigned	1	R	R
Time_Delay	Unsigned	-	O	R*
Notification_Class	Unsigned	-	O	R*
Feedback_Value	Unsigned	-	O	W
Event_Enable	BACnetEventTransitionBits	-	O	R*
Acked_Transitions	BACnetEventTransitionBits	-	O	R*
Notify_Type	BACnetNotifyType	-	O	R*
Event_Time_Stamps	BACnetArray[N] of BACnetTimeStamp	-	O	R*
Profile_Name	CharacterString	-	O	-

* Only available when specific object has a Notification Class configured

Vent Mode table

Vent Mode interpretation is possible using the value in the following correspondence table.

Present Value	Contents displayed in State_Text
1	Bypass
2	HeatEx
3	Sleep
4	Auto

5.3.74 OxxUxx_Vent. FanSpeed_S (Multistate Input Object Type)

Property Identifier	Property Datatype	Value	ASHRAE	IBOX
Object_Identifier	BACnetObjectIdentifier	(Multi-state Input, (xxx*100) + 6)	R	R
Object_Name	CharacterString	<i>OxxUxx_Vent. FanSpeed_S</i>	R	R
Object_Type	BACnetObjectType	MULTISTATE_INPUT (13)	R	R
Present_Value	Unsigned	x	R	R
Description	CharacterString	-	O	-
Device_Type	CharacterString	-	O	-
Status_Flags	BACnetStatusFlags	{FALSE, FALSE/TRUE, FALSE, FALSE}	R	R
Event_State	BACnetEventState	STATE_NORMAL (0)	R	R
Reliability	BACnetReliability	NO_FAULT_DETECTED (0), UNRELIABLE_OTHER (7)	O	R
Out_Of_Service	BOOLEAN	FALSE	R	R
Number_Of_States	Unsigned	3	R	R
State_Text	BACnetArray[N] of CharacterString	<i>Check Vent FanSpeed table below</i>	O	R
Time_Delay	Unsigned	-	O	R*
Notification_Class	Unsigned	-	O	R*
Alarm_Values	List of Unsigned	-	O	R*
Fault_Values	List of Unsigned	-	O	R*
Event_Enable	BACnetEventTransitionBits	-	O	R*
Acked_Transitions	BACnetEventTransitionBits	-	O	R*
Notify_Type	BACnetNotifyType	-	O	R*
Event_Time_Stamps	BACnetArray[N] of BACnetTimeStamp	-	O	R*
Profile_Name	CharacterString	-	O	-

* Only available when specific object has a Notification Class configured

Vent FanSpeed table

Vent FanSpeed interpretation is possible using the value in the following correspondence table.

Present_Value	Contents displayed in State_Text
1	Low
2	High
3	Turbo

5.3.75 OxxUxx_Vent. FanSpeed_C (Multistate Output Object Type)

Property Identifier	Property Datatype	Value	ASHRAE	IBOX
Object_Identifier	BACnetObjectIdentifier	(Multi-state Output, (xxx*100) + 4)	R	R
Object_Name	CharacterString	<i>OxxUxx_Vent. FanSpeed_C</i>	R	R
Object_Type	BACnetObjectType	MULTISTATE_OUTPUT (14)	R	R
Present_Value	Unsigned	x	W	W
Description	CharacterString	-	O	-
Device_Type	CharacterString	-	O	-
Status_Flags	BACnetStatusFlags	{FALSE, FALSE, FALSE, FALSE}	R	R
Event_State	BACnetEventState	STATE_NORMAL (0)	R	R
Reliability	BACnetReliability	NO_FAULT_DETECTED (0)	O	R
Out_Of_Service	BOOLEAN	FALSE	R	R
Number_Of_States	Unsigned	3	R	R
State_Text	BACnetArray[N] of CharacterString	<i>Check Vent FanSpeed table below</i>	O	R
Priority_Array	BACnetPriorityArray	BACnetPriorityArray	R	R
Relinquish_Default	Unsigned	1	R	R
Time_Delay	Unsigned	-	O	R*
Notification_Class	Unsigned	-	O	R*
Feedback_Value	Unsigned	-	O	W
Event_Enable	BACnetEventTransitionBits	-	O	R*
Acked_Transitions	BACnetEventTransitionBits	-	O	R*
Notify_Type	BACnetNotifyType	-	O	R*
Event_Time_Stamps	BACnetArray[N] of BACnetTimeStamp	-	O	R*
Profile_Name	CharacterString	-	O	-

* Only available when specific object has a Notification Class configured

Vent FanSpeed table

Vent FanSpeed interpretation is possible using the value in the following correspondence table.

Present Value	Contents displayed in State_Text
1	Low
2	High
3	Turbo

5.3.76 OxxUxx_WindFree_S (Binary Input Object Type)

Property Identifier	Property Datatype	Value	ASHRAE	IBOX
Object_Identifier	BACnetObjectIdentifier	(Binary Input, (xxx*100) + 6)	R	R
Object_Name	CharacterString	<i>OxxUxx_WindFree_S</i>	R	R
Object_Type	BACnetObjectType	BINARY_INPUT (3)	R	R
Present_Value	BACnetBinaryPV	INACTIVE (0) / ACTIVE (1)	R	R
Description	CharacterString	-	O	-
Device_Type	CharacterString	-	O	-
Status_Flags	BACnetStatusFlags	{FALSE, FALSE/TRUE, FALSE, FALSE}	R	R
Event_State	BACnetEventState	STATE_NORMAL (0)	R	R
Reliability	BACnetReliability	NO_FAULT_DETECTED (0), UNRELIABLE_OTHER (7)	O	R
Out_Of_Service	BOOLEAN	FALSE	R	R
Polarity	BACnetPolarity	NORMAL (0)	R	R
Inactive_Text	CharacterString	<i>"Disable"</i>	O	R
Active_Text	CharacterString	<i>"Enable"</i>	O	R
Change_Of_State_Time	BACnetDatetime	-	O	R
Change_Of_State_Count	Unsigned	-	O	R
Time_Of_State_Count_Reset	BACnetDatetime	-	O	R
Elapsed_Active_Time	Unsigned	-	O	R
Time_Of_Active_Time_Reset	BACnetDatetime	-	O	R
Time_Delay	Unsigned	-	O	R*
Notification_Class	Unsigned	-	O	R*
Alarm_Value	BACnetBinaryPV	-	O	R*
Event_Enable	BACnetEventTransitionBits	-	O	R*
Acked_Transitions	BACnetEventTransitionBits	-	O	R*
Notify_Type	BACnetNotifyType	-	O	R*
Event_Time_Stamps	BACnetArray[N] of BACnetTimeStamp	-	O	R*
Profile_Name	CharacterString	-	O	-

* Only available when specific object has a Notification Class configured

5.3.77 OxxUxx_WindFree_C (Binary Output Object Type)

Property Identifier	Property Datatype	Value	ASHRAE	IBOX
Object_Identifier	BACnetObjectIdentifier	(Binary Output, (xxx*100) + 7)	R	R
Object_Name	CharacterString	<i>OxxUxx_WindFree_C</i>	R	R
Object_Type	BACnetObjectType	BINARY_OUTPUT (4)	R	R
Present_Value	BACnetBinaryPV	INACTIVE (0) / ACTIVE (1)	W	W
Description	CharacterString	-	O	-
Device_Type	CharacterString	-	O	-
Status_Flags	BACnetStatusFlags	{FALSE, FALSE, FALSE, FALSE}	R	R
Event_State	BACnetEventState	STATE_NORMAL (0)	R	R
Reliability	BACnetReliability	NO_FAULT_DETECTED (0)	O	R
Out_Of_Service	BOOLEAN	FALSE	R	R
Polarity	BACnetPolarity	NORMAL (0)	R	R
Inactive_Text	CharacterString	<i>“Disable”</i>	O	R
Active_Text	CharacterString	<i>“Enable”</i>	O	R
Change_Of_State_Time	BACnetDatetime	-	O	R
Change_Of_State_Count	Unsigned	-	O	R
Time_Of_State_Count_Reset	BACnetDatetime	-	O	R
Elapsed_Active_Time	Unsigned	-	O	R
Time_Of_Active_Time_Reset	BACnetDatetime	-	O	R
Minimum_Off_Time	Unsigned32	-	O	-
Minimum_On_Time	Unsigned32	-	O	-
Priority_Array	BACnetPriorityArray	BACnetPriorityArray	R	R
Relinquish_Default	BACnetBinaryPV	INACTIVE (0)	R	R
Time_Delay	Unsigned	-	O	R*
Notification_Class	Unsigned	-	O	R*
Feedback_Value	BACnetBinaryPV	-	O	W
Event_Enable	BACnetEventTransitionBits	-	O	R*
Acked_Transitions	BACnetEventTransitionBits	-	O	R*
Notify_Type	BACnetNotifyType	-	O	R*
Event_Time_Stamps	BACnetArray[N] of BACnetTimeStamp	-	O	R*
Profile_Name	CharacterString	-	O	-

* Only available when specific object has a Notification Class configured

5.3.78 OxxUxx_Air_Clean_S (Binary Input Object Type)

Property Identifier	Property Datatype	Value	ASHRAE	IBOX
Object_Identifier	BACnetObjectIdentifier	(Binary Input, (xxx*100) + 7)	R	R
Object_Name	CharacterString	OxxUxx_Air_Clean_S	R	R
Object_Type	BACnetObjectType	BINARY_INPUT (3)	R	R
Present_Value	BACnetBinaryPV	INACTIVE (0) / ACTIVE (1)	R	R
Description	CharacterString	-	O	-
Device_Type	CharacterString	-	O	-
Status_Flags	BACnetStatusFlags	{FALSE, FALSE/TRUE, FALSE, FALSE}	R	R
Event_State	BACnetEventState	STATE_NORMAL (0)	R	R
Reliability	BACnetReliability	NO_FAULT_DETECTED (0), UNRELIABLE_OTHER (7)	O	R
Out_Of_Service	BOOLEAN	FALSE	R	R
Polarity	BACnetPolarity	NORMAL (0)	R	R
Inactive_Text	CharacterString	"Disable"	O	R
Active_Text	CharacterString	"Enable"	O	R
Change_Of_State_Time	BACnetDatetime	-	O	R
Change_Of_State_Count	Unsigned	-	O	R
Time_Of_State_Count_Reset	BACnetDatetime	-	O	R
Elapsed_Active_Time	Unsigned	-	O	R
Time_Of_Active_Time_Reset	BACnetDatetime	-	O	R
Time_Delay	Unsigned	-	O	R*
Notification_Class	Unsigned	-	O	R*
Alarm_Value	BACnetBinaryPV	-	O	R*
Event_Enable	BACnetEventTransitionBits	-	O	R*
Acked_Transitions	BACnetEventTransitionBits	-	O	R*
Notify_Type	BACnetNotifyType	-	O	R*
Event_Time_Stamps	BACnetArray[N] of BACnetTimeStamp	-	O	R*
Profile_Name	CharacterString	-	O	-

* Only available when specific object has a Notification Class configured

5.3.79 OxxUxx_Air_Clean_C (Binary Output Object Type)

Property Identifier	Property Datatype	Value	ASHRAE	IBOX
Object_Identifier	BACnetObjectIdentifier	(Binary Output, (xxx*100) + 8)	R	R
Object_Name	CharacterString	<i>OxxUxx_Air_Clean_C</i>	R	R
Object_Type	BACnetObjectType	BINARY_OUTPUT (4)	R	R
Present_Value	BACnetBinaryPV	INACTIVE (0) / ACTIVE (1)	W	W
Description	CharacterString	-	O	-
Device_Type	CharacterString	-	O	-
Status_Flags	BACnetStatusFlags	{FALSE, FALSE, FALSE, FALSE}	R	R
Event_State	BACnetEventState	STATE_NORMAL (0)	R	R
Reliability	BACnetReliability	NO_FAULT_DETECTED (0)	O	R
Out_Of_Service	BOOLEAN	FALSE	R	R
Polarity	BACnetPolarity	NORMAL (0)	R	R
Inactive_Text	CharacterString	<i>"Disable"</i>	O	R
Active_Text	CharacterString	<i>"Enable"</i>	O	R
Change_Of_State_Time	BACnetDatetime	-	O	R
Change_Of_State_Count	Unsigned	-	O	R
Time_Of_State_Count_Reset	BACnetDatetime	-	O	R
Elapsed_Active_Time	Unsigned	-	O	R
Time_Of_Active_Time_Reset	BACnetDatetime	-	O	R
Minimum_Off_Time	Unsigned32	-	O	-
Minimum_On_Time	Unsigned32	-	O	-
Priority_Array	BACnetPriorityArray	BACnetPriorityArray	R	R
Relinquish_Default	BACnetBinaryPV	INACTIVE (0)	R	R
Time_Delay	Unsigned	-	O	R*
Notification_Class	Unsigned	-	O	R*
Feedback_Value	BACnetBinaryPV	-	O	W
Event_Enable	BACnetEventTransitionBits	-	O	R*
Acked_Transitions	BACnetEventTransitionBits	-	O	R*
Notify_Type	BACnetNotifyType	-	O	R*
Event_Time_Stamps	BACnetArray[N] of BACnetTimeStamp	-	O	R*
Profile_Name	CharacterString	-	O	-

* Only available when specific object has a Notification Class configured

5.3.80 OxxUxx_360_CST_Air_Flow_S (Multistate Input Object Type)

Property Identifier	Property Datatype	Value	ASHRAE	IBOX
Object_Identifier	BACnetObjectIdentifier	(Multi-state Input, (xxx*100) + 7)	R	R
Object_Name	CharacterString	<i>OxxUxx_360_CST_Air_Flow_S</i>	R	R
Object_Type	BACnetObjectType	MULTISTATE_INPUT (13)	R	R
Present_Value	Unsigned	x	R	R
Description	CharacterString	-	O	-
Device_Type	CharacterString	-	O	-
Status_Flags	BACnetStatusFlags	{FALSE, FALSE/TRUE, FALSE, FALSE}	R	R
Event_State	BACnetEventState	STATE_NORMAL (0)	R	R
Reliability	BACnetReliability	NO_FAULT_DETECTED (0), UNRELIABLE_OTHER (7)	O	R
Out_Of_Service	BOOLEAN	FALSE	R	R
Number_Of_States	Unsigned	4	R	R
State_Text	BACnetArray[N] of CharacterString	<i>Check 360_CST_Air_Flow table below</i>	O	R
Time_Delay	Unsigned	-	O	R*
Notification_Class	Unsigned	-	O	R*
Alarm_Values	List of Unsigned	-	O	R*
Fault_Values	List of Unsigned	-	O	R*
Event_Enable	BACnetEventTransitionBits	-	O	R*
Acked_Transitions	BACnetEventTransitionBits	-	O	R*
Notify_Type	BACnetNotifyType	-	O	R*
Event_Time_Stamps	BACnetArray[N] of BACnetTimeStamp	-	O	R*
Profile_Name	CharacterString	-	O	-

* Only available when specific object has a Notification Class configured

360_CST_Air_Flow table

360_CST_Air_Flow interpretation is possible using the value in the following correspondence table.

Present_Value	Contents displayed in State_Text
1	Spot
2	Mid
3	Wide
4	Swing

5.3.81 OxxUxx_360_CST_Air_Flow_C (Multistate Output Object Type)

Property Identifier	Property Datatype	Value	ASHRAE	IBOX
Object_Identifier	BACnetObjectIdentifier	(Multi-state Output, (xxx*100) + 5)	R	R
Object_Name	CharacterString	<i>OxxUxx_360_CST_Air_Flow_C</i>	R	R
Object_Type	BACnetObjectType	MULTISTATE_OUTPUT (14)	R	R
Present_Value	Unsigned	x	W	W
Description	CharacterString	-	O	-
Device_Type	CharacterString	-	O	-
Status_Flags	BACnetStatusFlags	{FALSE, FALSE, FALSE, FALSE}	R	R
Event_State	BACnetEventState	STATE_NORMAL (0)	R	R
Reliability	BACnetReliability	NO_FAULT_DETECTED (0)	O	R
Out_Of_Service	BOOLEAN	FALSE	R	R
Number_Of_States	Unsigned	4	R	R
State_Text	BACnetArray[N] of CharacterString	<i>Check 360_CST_Air_Flow table below</i>	O	R
Priority_Array	BACnetPriorityArray	BACnetPriorityArray	R	R
Relinquish_Default	Unsigned	1	R	R
Time_Delay	Unsigned	-	O	R*
Notification_Class	Unsigned	-	O	R*
Feedback_Value	Unsigned	-	O	W
Event_Enable	BACnetEventTransitionBits	-	O	R*
Acked_Transitions	BACnetEventTransitionBits	-	O	R*
Notify_Type	BACnetNotifyType	-	O	R*
Event_Time_Stamps	BACnetArray[N] of BACnetTimeStamp	-	O	R*
Profile_Name	CharacterString	-	O	-

* Only available when specific object has a Notification Class configured

360_CST_Air_Flow table

360_CST_Air_Flow interpretation is possible using the value in the following correspondence table.

Present_Value	Contents displayed in State_Text
1	Spot
2	Mid
3	Wide
4	Swing

6 Connections

Find below information regarding the Intesis connections available.

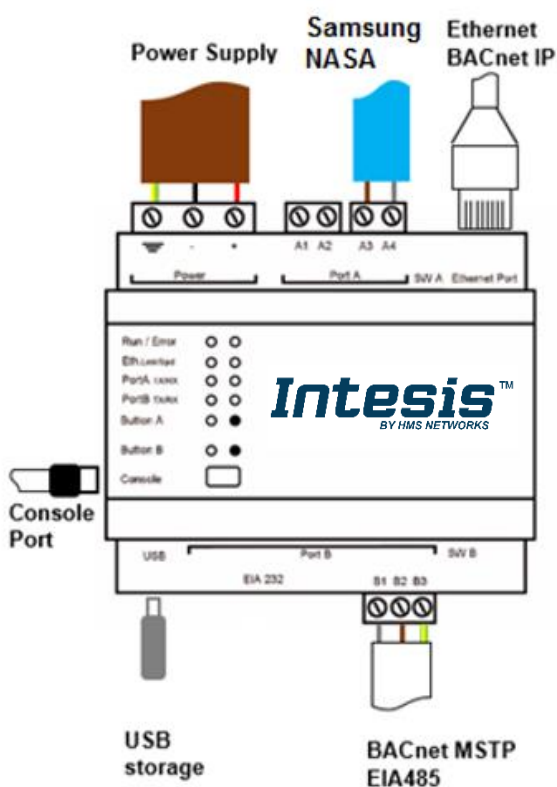

Power Supply

Must use NEC Class 2 or Limited Power Source (LPS) and SELV rated power supply.

If using DC power supply:

Respect polarity applied of terminals (+) and (-). Be sure the voltage applied is within the range admitted (check table below). The power supply can be connected to earth but only through the negative terminal, never through the positive terminal.

If using AC power supply:

Make sure the voltage applied is of the value admitted (24 Vac). Do not connect any of the terminals of the AC power supply to earth, and make sure the same power supply is not supplying any other device.

Ethernet / BACnet IP

Connect the cable coming from the IP network to the connector ETH of the gateway. Use an Ethernet CAT5 cable. If communicating through the LAN of the building, contact the network administrator and make sure traffic on the port used is allowed through all the LAN path (check the gateway user manual for more information). Default IP is 192.168.100.246. DHCP is enabled by default.

PortA / Samsung NASA

Connect the R1/R2 bus of Samsung NASA Outdoor Units to the connectors A3 (R1) A4 (R2) of gateway's PortA. Respect the polarity.

PortB / BACnet MSTP

Connect the EIA485 bus to connectors B1 (-), B2 (+) and B3 (SNGD) of gateway's PortB. Respect the polarity. Remember the characteristics of the standard EIA485 bus: maximum distance of 1200 meters, maximum 32 devices connected to the bus, and in each end of the bus it must be a termination resistor of 120 Ω. The gateway has an internal bus biasing circuit that incorporates the termination resistor. If you install the gateway in one of the ends of the bus, then do not install an additional termination resistor in that end.

Console Port

Connect a mini-type B USB cable from your computer to the gateway to allow communication between the Configuration Software and the gateway. Remember that Ethernet connection is also allowed. Check the user manual for more information.

USB

Connect a USB storage device (not a HDD) if required. Check the user manual for more information.

Ensure proper space for all connectors when mounted (see section [9 Dimensions](#))

6.1 Power device

The first step to perform is to power up the device. To do so, a power supply working with any of the voltage range allowed is needed (check section 8). Once connected the ON led will turn on.

WARNING! In order to avoid earth loops that can damage the gateway and/or any other equipment connected to it, we strongly recommend:

- The use of DC power supplies, floating or with the negative terminal connected to earth. **Never use a DC power supply with the positive terminal connected to earth.**
- The use of AC power supplies only if they are floating and not powering any other device.

6.2 Connection to BACnet

6.2.1 BACnet IP

Connect the communication cable coming from the network hub or switch to the ETH port (Figure above) of Intesis. The cable to be used shall be a straight Ethernet UTP/FTP CAT5 cable

In case there is no response from the BACnet devices to the frames sent by Intesis, check that they are operative and reachable from the network connection used by Intesis. Check the Intesis Ethernet interface sending *Pings* to its IP address using a PC connected to the same Ethernet network.

Check as well with the network admin that there are no limitations regarding UDP communication or ports blocked.

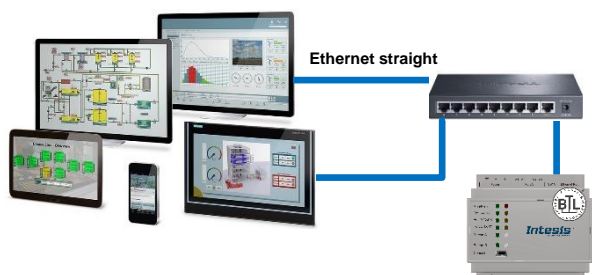

BACnet IP connection using switch/hub and straight cable



BACnet IP connection without switch/hub and crossed cable

6.2.2 BACnet MSTP

Connect the EIA485 bus to connectors A3 (+), A4 (-) and A1 or A2 (SNGD) of gateway's PortA. Respect the polarity.

Remember the characteristics of the standard EIA485 bus: maximum distance of 1200 meters, maximum 32 devices connected to the bus, and in each end of the bus it must be a termination resistor of 120 Ω . The gateway has an internal bus biasing circuit that incorporates the termination resistor. If you install the gateway in one of the ends of the bus, then do not install an additional termination resistor in that end.

6.3 Connect to Samsung NASA installation

Use the PortA connector in the top corner of the Intesis device in order to connect Samsung NASA bus to the Intesis. Remember to follow all safety precautions indicated by Samsung.

To properly communicate with the Intesis, take into account following considerations:

- Samsung NASA AC network allows for both automatic and manual addressing. **Manual addressing of both indoor and outdoor units must be setup by Samsung installer in order that Intesis communicates properly.** Manual addressing is setup by means of DIP switches in outdoor unit, and using the remote controller or DIP switches in the indoor unit.
- Samsung NASA indoor units **need to be configured to accept 'central control'**. To do so, they need to be configured with so-called 'installation option code' in which segment 5 of this code needs to be set to value '1' to allow central control.

Connect the Samsung NASA bus to connectors A3 (R1/+) and A4 (R2/-) of gateway's PortA. Respect the polarity.

6.4 Connection to the configuration tool

This action allows the user to have access to configuration and monitoring of the device (more information can be found in the configuration tool User Manual). Two methods to connect to the PC can be used:

- **Ethernet:** Using the Ethernet port of Intesis.
- **USB:** Using the console port of Intesis, connect a USB cable from the console port to the PC.

7 Set-up process and troubleshooting

7.1 Pre-requisites

It is necessary to have a BACnet IP client or MSTP device operative and well connected to the corresponding BACnet port of Intesis and a Modbus RTU slave or Modbus TCP client connected to their corresponding ports as well.

Connectors, connection cables, PC to use the configuration tool and other auxiliary material, if needed, are not supplied by HMS Industrial Networks S.L.U for this standard integration.

Items supplied by HMS Networks for this integration are:

- Intesis gateway.
- Link to download the configuration tool.
- Product documentation.

7.2 Intesis MAPS. Configuration & monitoring tool for Intesis BACnet series

7.2.1 Introduction

Intesis MAPS is a Windows® compatible software developed specifically to monitor and configure Intesis new generation gateways.

The installation procedure and main functions are explained in the *Intesis MAPS BACnet User Manual*. This document can be downloaded from the link indicated in the installation sheet supplied with the Intesis device or in the product website at www.intesis.com

In this section, only the specific case of Samsung NASA to BACnet systems will be covered.

Please check the Intesis MAPS BACnet User Manual for specific information about the different parameters and how to configure them.

7.2.2 Connection

To configure the Intesis connection parameters press on the **Connection** button in the *menu bar*.

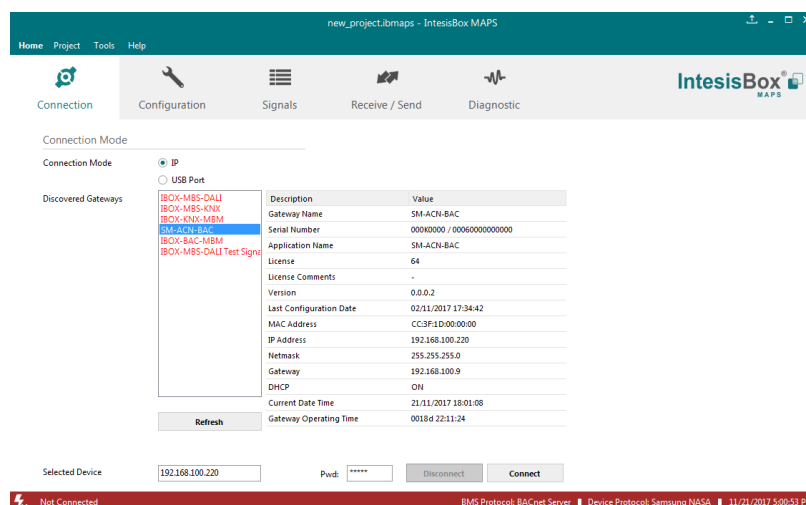

Figure 7.1 MAPS connection

7.2.3 Configuration tab

Select the **Configuration** tab to configure the connection parameters. Three subsets of information are shown in this window: General (Gateway general parameters), BACnet Server (BACnet interface configuration) and Samsung NASA (Samsung NASA interface parameters).

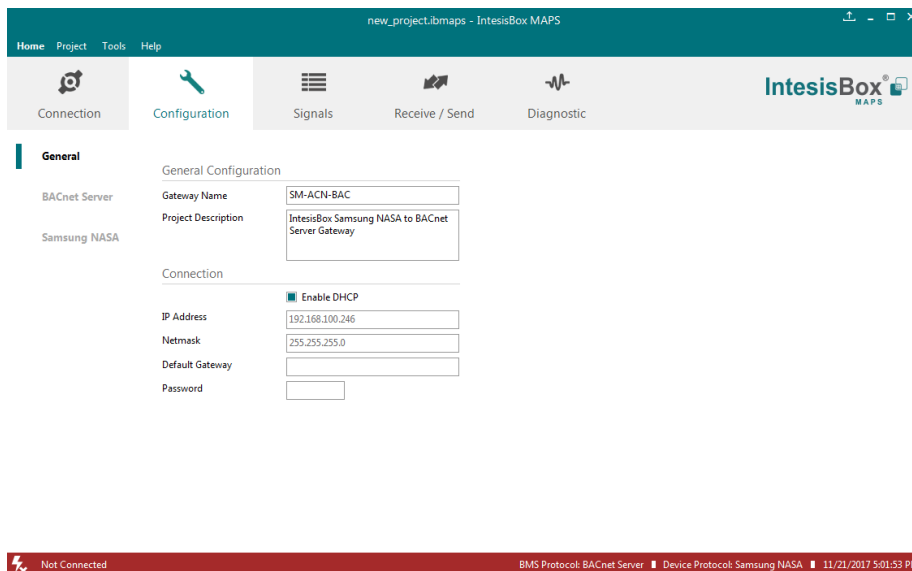

Figure 7.2 Intesis MAPS configuration tab

7.2.4 BACnet Server configuration

Set parameters of BACnet interface of Intesis.

Find description of these settings in *Intesis MAPS BACnet User Manual*.

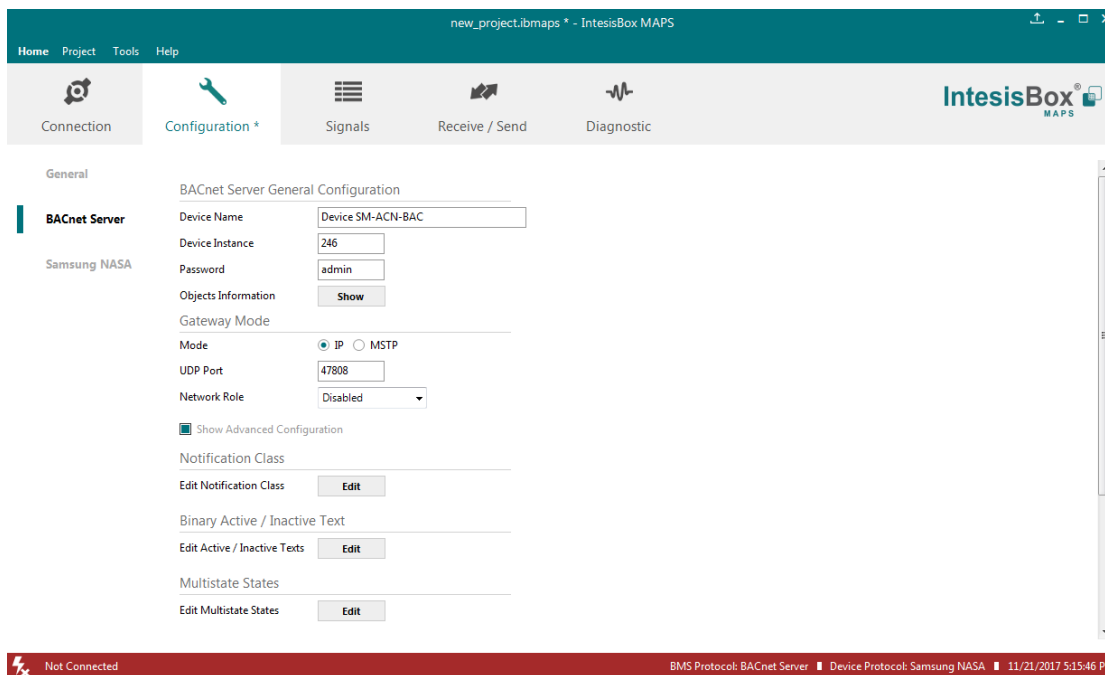

Figure 7.3 Intesis MAPS BACnet configuration tab

7.2.5 Samsung NASA configuration

Set parameters for connection with Samsung NASA's installation.

Unit ID	Unit Type	IU	OU	Description
<input checked="" type="checkbox"/> Unit 1	IU	0	1	Indoor Unit 1
<input checked="" type="checkbox"/> Unit 2	IU	1	1	Indoor Unit 2
<input type="checkbox"/> Unit 3	IU	2	1	Indoor Unit 3
<input type="checkbox"/> Unit 4	IU	3	1	Indoor Unit 4
<input type="checkbox"/> Unit 5	IU	4	1	Indoor Unit 5
<input type="checkbox"/> Unit 6	IU	5	1	Indoor Unit 6
<input type="checkbox"/> Unit 7	IU	6	1	Indoor Unit 7
<input type="checkbox"/> Unit 8	IU	7	1	Indoor Unit 8
<input type="checkbox"/> Unit 9	IU	8	1	Indoor Unit 9
<input type="checkbox"/> Unit 10	IU	9	1	Indoor Unit 10
<input type="checkbox"/> Unit 11	IU	10	1	Indoor Unit 11
<input type="checkbox"/> Unit 12	IU	11	1	Indoor Unit 12
<input type="checkbox"/> Unit 13	IU	12	1	Indoor Unit 13
<input type="checkbox"/> Unit 14	IU	13	1	Indoor Unit 14
<input type="checkbox"/> Unit 15	IU	14	1	Indoor Unit 15
<input type="checkbox"/> Unit 16	IU	15	1	Indoor Unit 16
<input type="checkbox"/> Unit 17	IU	16	1	Indoor Unit 17

Supported Active Units: 64

Figure 7.4 Intesis MAPS Samsung NASA configuration tab

In Units Configuration section you need to enter, for each unit:

- **Active.** If it's active (checkbox at Unit xx), ranging from 1 to 64 indoor units that will be integrated (maximum number of units will depend on Intesis model)
- **Unit type.** Type can be one of the following: IU, HE, HT, EHS, AHU, ERV, ERV+, CHILLER. Available signals will vary according to unit type.
- **IU address.** Address 0..63 of Unit in Samsung NASA R1/R2 bus. Remember that manual addressing of Samsung indoor units is required.
- **OU address.** Address 0..15 of Outdoor Unit in Samsung NASA R1/R2 bus. Remember that manual addressing of Samsung indoor units is required.
- **Description.** Descriptive name to ease identification of the unit (for example, 'living room floor 1 unit', etc).

Additional to manual entry of each unit, autodiscover of present units in an R1/R2 installation is possible. To do so, click button **Scan**. Following window will appear:

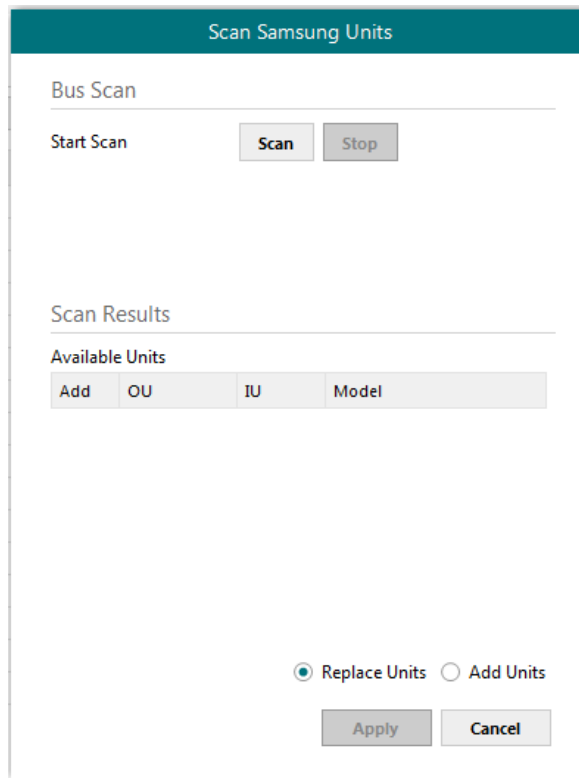

Figure 7.5 Intesis MAPS Scan Samsung Units window

By pressing **Scan** button, connected Samsung NASA R1/R2 bus will be scanned for available units. Error window will appear if there is a problem in the connection with R1/R2 bus (units not powered, bus not connected, ...).

A progress bar will appear during the scan, which will take up to a few minutes. After scan is completed, detected units will be shown in available units as follows:

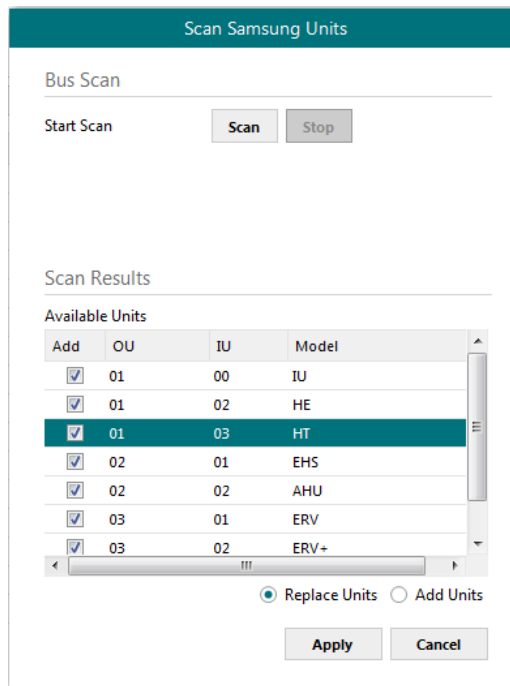

Figure 7.6 Intesis MAPS Scan Samsung Units window with scan results

Select with its checkbox units to add (or replace) in installation, according to selection **Replace Units / Add Units**. After units to be integrated are selected, click button **Apply**, and changes will appear in previous **Units Configuration** window.

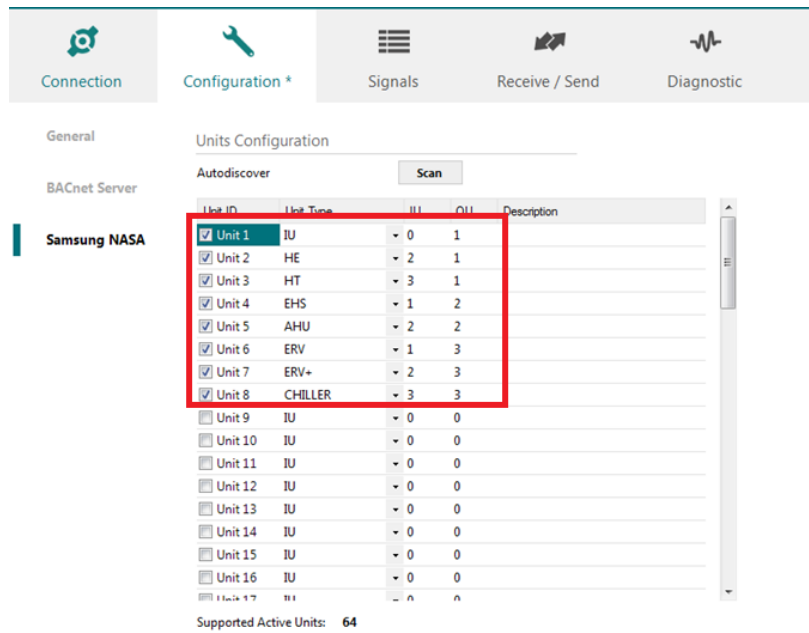

Figure 7.7 Intesis MAPS Samsung NASA configuration tab after importing scan results

7.2.6 Signals

All available objects, Object Instances, its corresponding AC signal and other main parameters are listed in the signals tab. More information on each parameter and how to configure it can be found in the Intesis MAPS BACnet user manual.

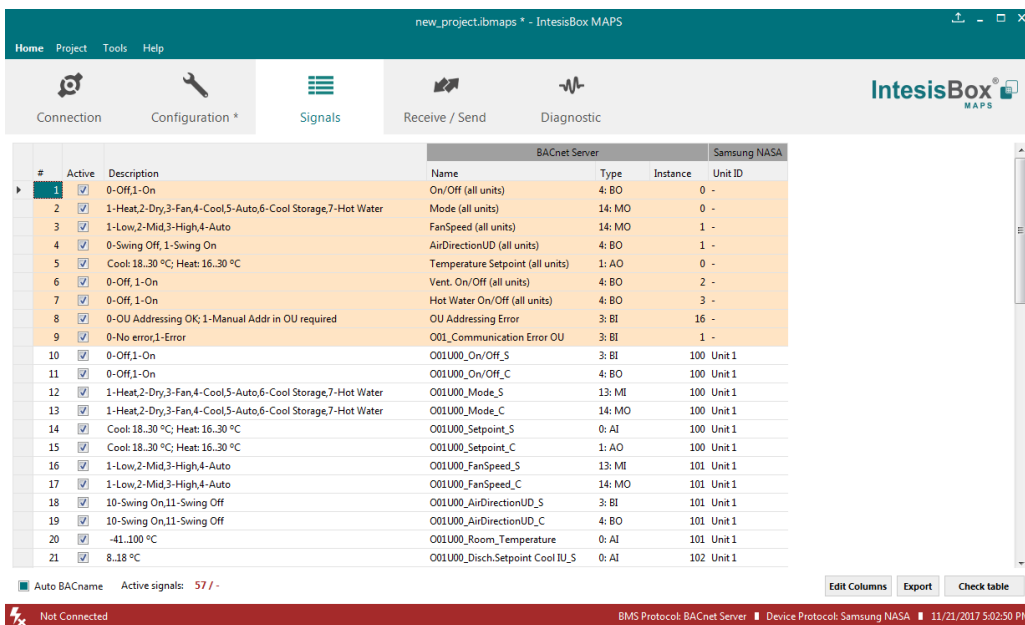

Figure 7.8 Intesis MAPS Signals tab

7.2.7 Sending the configuration to Intesis

When the configuration is finished, follow the next steps.

- 1.- Save the project (Menu option **Project->Save**) on your hard disk (more information in Intesis MAPS User Manual).
- 2.- Go to tab '**Receive / Send**' of MAPS, and in **Send** section, press **Send** button. Intesis will reboot automatically once the new configuration is loaded.

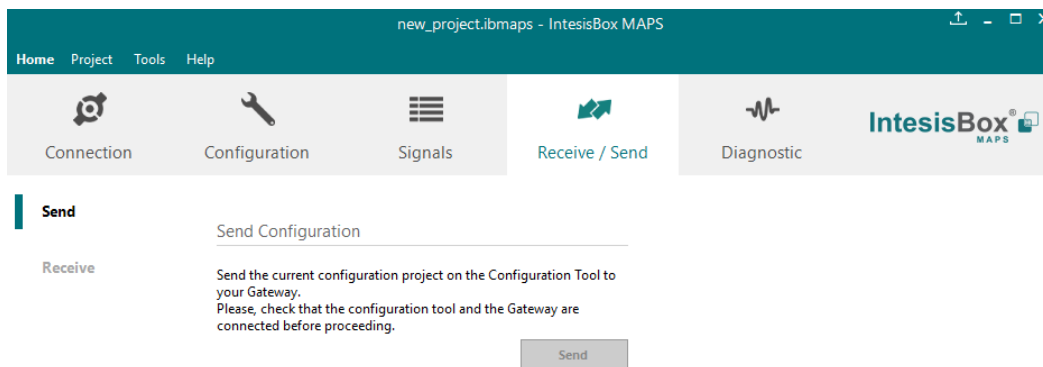

Figure 7.9 Intesis MAPS Receive/Send tab

After any configuration change, do not forget to send the configuration file to the Intesis using button Send File.

7.2.8 Diagnostic

To help integrators in the commissioning tasks and troubleshooting, the Configuration Tool offers some specific tools and viewers.

In order to start using the diagnostic tools, connection with the Gateway is required.

The Diagnostic section is composed by two main parts: Tools and Viewers.

- **Tools**
Use the tools section to check the current hardware status of the box, log communications into compressed files to be sent to the support, change the Diagnostic panels' view or send commands to the gateway.
- **Viewers**
In order to check the current status, viewer for the Internal and External protocols are available. It is also available a generic Console viewer for general information about communications and the gateway status and finally a Signals Viewer to simulate the BMS behavior or to check the current values in the system.

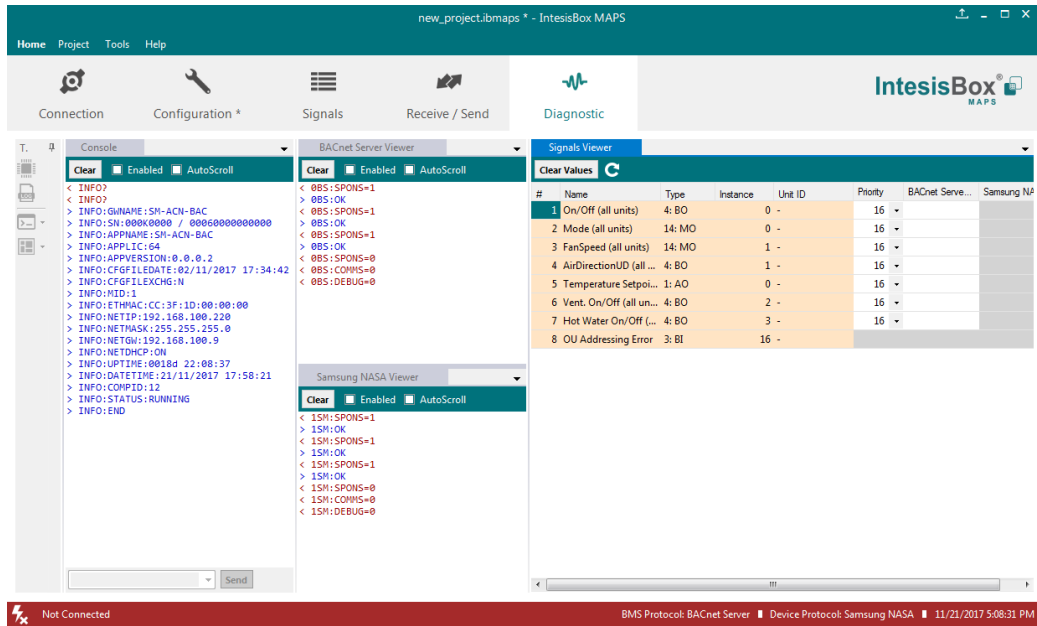

Figure 7.10 Diagnostic

More information about the Diagnostic section can be found in the Configuration Tool manual.

7.2.9 Set-up procedure

1. Install Intesis MAPS on your laptop, use the setup program supplied for this and follow the instructions given by the Installation wizard.
2. Install Intesis in the desired installation site. Installation can be on DIN rail or on a stable not vibrating surface (DIN rail mounted inside a metallic industrial cabinet connected to ground is recommended).
3. If using BACnet IP, connect the communication cable coming from the BACnet IP network to the port marked as Ethernet on Intesis (More details in section 6).

If using BACnet MSTP, connect the communication cables coming from the BACnet MSTP network to the port marked as Port B on Intesis (More details in section 6).

4. Connect the communication cable coming from the Samsung NASA R1/R2 installation to the port marked as Port A of Intesis (More details in section 6).
5. Power up Intesis. The supply voltage can be 9 to 30 Vdc or just 24 Vac. Take care of the polarity of the supply voltage applied.

WARNING! In order to avoid earth loops that can damage Intesis and/or any other equipment connected to it, we strongly recommend:

- The use of DC power supplies, floating or with the negative terminal connected to earth. **Never use a DC power supply with the positive terminal connected to earth.**
 - The use of AC power supplies only if they are floating and not powering any other device.
6. If you want to connect using IP, connect the Ethernet cable from the laptop PC to the port marked as Ethernet of Intesis (More details in section 6).

If you want to connect using USB, connect the USB cable from the laptop PC to the port marked as Console of Intesis (More details in section 6).

7. Open Intesis MAPS, create a new project selecting a copy of the one named **INBACSAM---0000**.
8. Modify the configuration as desired, save it and download the configuration file to Intesis as explained in the Intesis MAPS user manual.
9. Visit the Diagnostic section and check that there is communication activity, some TX frames and some other RX frames. This means that the communication with the BACnet master device and Samsung installation is OK. In case there is no communication activity between Intesis and the BACnet and/or Samsung units, check that those are operative: check communication cable used to connect all devices and any other communication parameter.

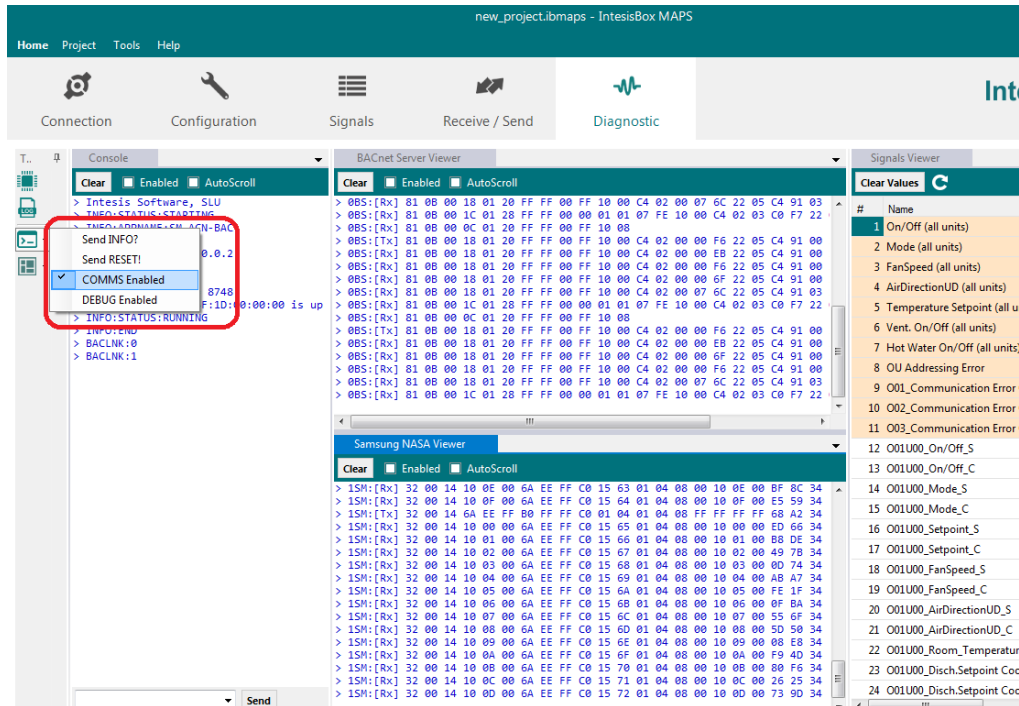

Figure 7.11 Enable COMMS

8 Electrical & Mechanical Features



Enclosure	Plastic, type PC (UL 94 V-0) Net dimensions (dxwxh): 90x88x56 mm Recommended space for installation (dxwxh): 130x100x100mm Color: Light Grey, RAL 7035	Battery	Size: Coin 20mm x 3.2mm Capacity: 3V / 225mAh Type: Manganese Dioxide Lithium
Mounting	Wall. DIN rail EN60715 TH35.	Console Port	Mini Type-B USB 2.0 compliant 1500VDC isolation
Terminal Wiring (for power supply and low-voltage signals)	Per terminal: solid wires or stranded wires (twisted or with ferrule) 1 core: 0.5mm ² ... 2.5mm ² 2 cores: 0.5mm ² ... 1.5mm ² 3 cores: not permitted	USB port	Type-A USB 2.0 compliant Only for USB flash storage device (USB pen drive) Power consumption limited to 150mA (HDD connection not allowed)
Power	1 x Plug-in screw terminal block (3 poles) 9 to 36VDC +/-10%, Max.: 140mA. 24VAC +/-10% 50-60Hz, Max.: 127mA Recommended: 24VDC	Push Button	Button A: Not used Button B: Sends I-Am message to all BACnet ports
Ethernet	1 x Ethernet 10/100 Mbps RJ45 2 x Ethernet LED: port link and activity	Operation Temperature	0°C to +60°C
Port A	1 x Samsung Nasa port Plug-in screw terminal block orange (2 poles) R1 R2 (Samsung Nasa) 1 x Plug-in screw terminal block green (2 poles) Reserved for future use 1500VDC isolation from other ports	Operational Humidity	5 to 95%, no condensation
Switch A (SWA)	1 x DIP-Switch for PORTB configuration: Reserved for future use, leave defaults (all OFF)	Protection	IP20 (IEC60529)
PORT B	1 x Serial EIA232 (SUB-D9 male connector) <i>Not used</i> 1 x Serial EIA485 Plug-in screw terminal block (3 poles) A, B, SGND (Reference ground or shield) 1500VDC isolation from other ports (except PORT B: EIA232)	LED Indicators	10 x On board LED indicators 1 x Error LED 1 x Power LED 2 x Ethernet Link/Speed 2 x Port A TX/RX 2 x Port B TX/RX 1 x Button A indicator 1 x Button B indicator
Switch B (SWB)	1 x DIP-Switch for serial EIA485 configuration: Position 1: ON: 120 Ω termination active Off: 120 Ω termination inactive (default) Position 2-3: ON: Polarization active Off: Polarization inactive (default)		

9 Dimensions

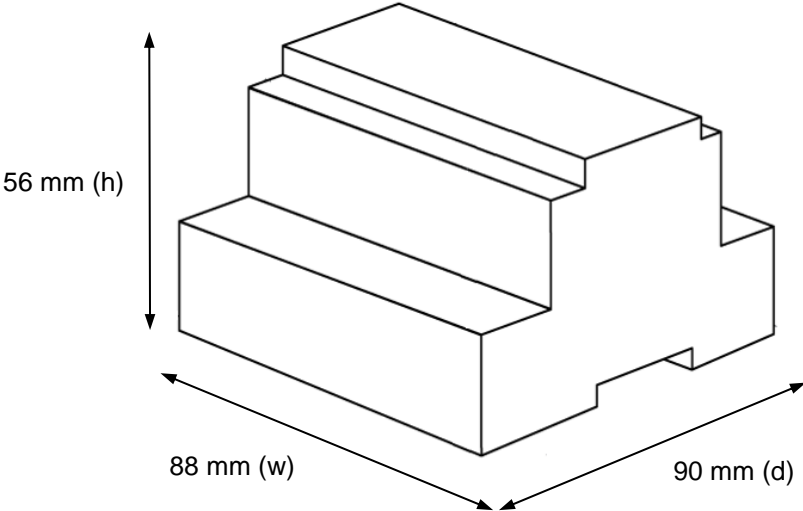

Recommended available space for its installation into a cabinet (wall or DIN rail mounting), with space enough for external connections

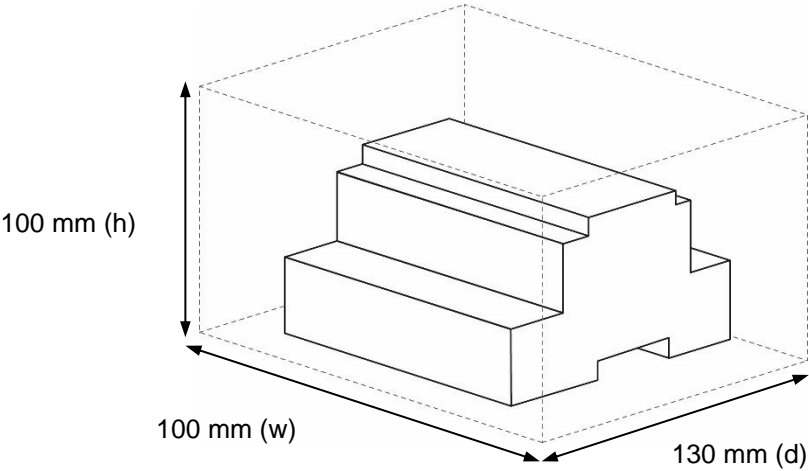

10 AC Unit Types compatibility

A list of Samsung unit model references compatible with INBACSAM---O000 and their available features can be found in:

https://www.intesis.com/docs/compatibilities/inxxsam0xxo000_compatibility

Error codes for Indoor and Outdoor Units

This list contains all possible values shown in Bacnet Object for "Error Code" for each indoor unit and outdoor unit.

It must be taken into account that Outdoor Units are only able to reflect a single error for each indoor / outdoor unit in the system. Thus, a unit having two or more active errors from that list will only report a single error code – the one of the first error that has been detected.

Error Code	Description
101	Indoor unit communication error. Indoor unit can not receive any data from outdoor unit.
102	Communication error between indoor unit and outdoor unit. Displayed in indoor unit.
108	Error due to repeated address setting (When 2 or more devices has same address within the
110	Communication error between Hydro unit HT(Main PBA) and Control kit PBA(Detection from the Control kit)
121	Error on indoor temperature sensor of indoor unit (Short or Open)
122	Error on EVA IN sensor of indoor unit (Short or Open)
123	Error on EVA OUT sensor of indoor unit (Short or Open)
128	EVA IN temperature sensor of indoor unit is detached from EVA IN pipe
129	EVA OUT temperature sensor of indoor unit is detached from EVA OUT pipe
130	Heat exchanger in/out sensors of indoor unit are detached
135	RPM feedback error of indoor unit's cleaning fan
151	Error due to opened EEV of indoor unit (2nd detection)
152	Error due to closed EEV of indoor unit (2nd detection)
153	Error on floating switch of indoor unit (2nd detection)
154	RPM feedback error of indoor unit
161	Mixed operation mode error of indoor unit; When outdoor unit is getting ready to operate in cooling (or heating) and some of the indoor unit is trying to operate in heating (or cooling) mode
162	EEPROM error of MICOM (Physical problem of parts/circuit)
163	Indoor unit's remote controller option input is Incorrect or missing. Outdoor unit EEPROM data error
180	Simultaneous opening of cooling/heating MCU SOL V/V (1st detection)
181	Simultaneous opening of cooling/heating MCU SOL V/V (2nd detection)
185	Cross wiring error between communication and power cable of indoor unit
186	Connection error or problem on SPi
190	No temperature changes in EVA IN during pipe inspection or changes in temperature indoor unit with wrong address
191	No temperature changes in EVA OUT during pipe inspection or changes in temperature is seen in indoor unit with wrong address
198	Error due to disconnected thermal fuse of indoor unit
201	Communication error between indoor and outdoor units (installation number setting error, repeated indoor unit address, indoor unit communication cable error)
202	Communication error between indoor and outdoor units (Communication error on all indoor unit, outdoor unit communication cable error)
203	Communication error between main and sub outdoor units
205	Communication error on all PBA within the outdoor unit C-Box, communication cable error
206	E206-C001: HUB PBA communication error / E206-C002: FAN PBA communication error E206-C003: INV1 PBA communication error / E206-C004: INV2 PBA communication error
211	When single indoor unit uses 2 MCU ports that are not in series.
212	If the rotary switch (on the MCU) for address setting of the indoor unit has 3 or more of the same address

213	When total number of indoor units assigned to MCU is same as actual number of installed indoor units but there is indoor unit that is not installed even though it is assigned on MCU
214	When number of MCU is not set correctly on the outdoor unit or when two or more MCU was installed some of them have the same address
215	When two different MCU's have same address value on the rotary switch
216	When indoor unit is not installed to a MCU port but the switch on the port is set to On.
217	When indoor unit is connected to a MCU port but indoor unit is assigned to a MCU and the switch on the port is set to Off
218	When there's at least one or more actual number of indoor unit connection compared to number of indoor units assigned to MCU
219	Error on temperature sensor located on MCU intercooler inlet (Short or Open)
220	Error on temperature sensor located on MCU intercooler outlet (Short or Open)
221	Error on outdoor temperature sensor of outdoor unit (Short or open)
231	Error on COND OUT temperature sensor of main outdoor unit (Short or Open)
241	COND OUT sensor is detached
251	Error on discharge temperature sensor of compressor 1 (Short or Open)
257	Error on discharge temperature sensor of compressor 2 (Short or Open)
262	Discharge temperature sensor of compressor 1 is detached from the sensor holder on the pipe
263	Discharge temperature sensor of compressor 2 is detached from the sensor holder on the pipe
266	Top sensor of compressor 1 is detached
267	Top sensor of compressor 2 is detached
269	Suction temperature sensor is detached from the sensor holder on the pipe
276	Error on top sensor of compressor 1 (Short or Open)
277	Error on top sensor of compressor 2 (Short or Open)
291	Refrigerant leakage or error on high pressure sensor (Short or Open)
296	Refrigerant leakage or error on low pressure sensor (Short or Open)
308	Error on suction temperature sensor (Short or Open)
311	Error on temperature sensor of double layer pipe/liquid pipe(sub heat exchanger) (Short or Open)
321	Error on EVI (ESC) IN temperature sensor (Short or Open)
322	Error on EVI (ESC) OUT temperature sensor (Short or Open)
323	Error on suction sensor 2 (Short or Open)
346	Error due to operation failure of Fan2
347	Motor wire of Fan2 is not connected
348	Lock error on Fan2 of outdoor unit
353	Error due to overheated motor of outdoor unit's Fan2
355	Error due to overheated IPM of Fan2
361	Error due to operation failure of inverter compressor 2
364	Error due to over-current of inverter compressor 2
365	V-limit error of inverter compressor 2
366	Error due to over voltage /low voltage of inverter PBA2
367	Error due to unconnected wire of compressor 2
368	Output current sensor error of inverter PBA2
369	DC voltage sensor error of inverter PBA2
374	Heat sink temperature sensor error of inverter PBA2
378	Error due to overcurrent of Fan2
385	Error due to input current of inverter 2
386	Over-voltage/low-voltage error of Fan2

387	Hall IC connection error of Fan2
389	V-limit error on Fan2 of compressor
393	Output current sensor error of Fan2
396	DC voltage sensor error of Fan2
399	Heat sink temperature sensor error of Fan2
400	Error due to overheat caused by contact failure on IPM of Inverter PBA2
407	Compressor operation stop due to high pressure protection control
410	Compressor operation stop due to low pressure protection control or refrigerant leakage
416	Compressor operation stop due to discharge temperature protection control
425	Phase reversal or phase failure (3Ø outdoor unit wiring, R-S-T-N), connection error on 3 phase input
428	Compressor operation stop due abnormal compression ratio
438	EVI (ESC) EEV leakage or internal leakage of intercooler or incorrect connector insertion of EVI (ESC) EEV
439	Error due to refrigerant leakage
440	Heating mode restriction due to high air temperature
441	Cooling mode restriction due to low air temperature
442	Refrigerant charging restriction in heating mode when air temperature is over 15 °C
443	Operation prohibited due to the pressure drop
445	CCH is deatched
446	Error due to operation failure of Fan1
447	Motor wire of Fan1 is not connected
448	Lock error on Fan1
452	Error due to ZPC detection circuit problem or power failure
453	Error due to overheated motor of outdoor unit's Fan1
455	Error due to overheated IPM of Fan1
461	Error due to operation failure of inverter compressor 1
462	Compressor stop due to full current control or error due to low current on CT2
464	Error due to over-current of inverter compressor 1
465	V-limit error of inverter compressor 1
466	Error due to over voltage /low voltage of inveter PBA1
467	Error due to unconnected wire of compressor 1
468	Output current sensor error of inverter PBA1
469	DC voltage sensor error of inver PBA1
474	Heat sink temperature sensor error of inverter PBA1
478	Error due to overcurrent of Fan1
485	Error due to input current of inverter 1
486	Error due to over voltage/low voltage of Fan
487	Hall IC error of Fan1
489	V-limit error on Fan1 of compressor
493	Output current sensor error of Fan1
496	DC voltage sensor error of Fan1
499	Heat sink temperature sensor error of Fan1
500	Error due to overheat caused by contact failure on IPM of Inverter PBA1
503	Error due to alert the user to check if the service valve is closed
504	Error due to self diagnosis of compressor operation
505	Error due to self diagnosis of high pressure sensor
506	Error due to self diagnosis of low pressure sensor
560	Outdoor unit's option switch setting error (when inappropriate option switch is on)
563	Error due to module installation of indoor unit with old version (Micom version needs to be