



# Interface for integration of Haier air conditioners into KNX TP-1 (EIB) control systems

Compatible with VRV air conditioners line commercialized by Haier

Application's Program Version: 1.0

## USER MANUAL

Issue date: 04/2022 r2.0 ENGLISH



## Interface for integration of Haier air conditioners into KNX TP-1 (EIB) control systems.

Compatible with VRF air conditioners line commercialized by Haier.

Application's Program Version: 1.0

<b>ORDER CODE</b>	<b>LEGACY ORDER CODE</b>
INKNXHAI008C000	HA-AC-KNX-8
INKNXHAI016C000	HA-AC-KNX-16
INKNXHAI064C000	HA-AC-KNX-64

## Important User Information

### Disclaimer

The information in this document is for informational purposes only. Please inform HMS Industrial Networks of any inaccuracies or omissions found in this document. HMS Industrial Networks disclaims any responsibility or liability for any errors that may appear in this document.

HMS Industrial Networks reserves the right to modify its products in line with its policy of continuous product development. The information in this document shall therefore not be construed as a commitment on the part of HMS Industrial Networks and is subject to change without notice. HMS Industrial Networks makes no commitment to update or keep current the information in this document.

The data, examples and illustrations found in this document are included for illustrative purposes and are only intended to help improve understanding of the functionality and handling of the product. In view of the wide range of possible applications of the product, and because of the many variables and requirements associated with any particular implementation, HMS Industrial Networks cannot assume responsibility or liability for actual use based on the data, examples or illustrations included in this document nor for any damages incurred during installation of the product. Those responsible for the use of the product must acquire sufficient knowledge in order to ensure that the product is used correctly in their specific application and that the application meets all performance and safety requirements including any applicable laws, regulations, codes and standards. Further, HMS Industrial Networks will under no circumstances assume liability or responsibility for any problems that may arise as a result from the use of undocumented features or functional side effects found outside the documented scope of the product. The effects caused by any direct or indirect use of such aspects of the product are undefined and may include e.g. compatibility issues and stability issues.

**INDEX**

1	Presentation.....	5
2	Connection .....	6
3	Configuration and setup .....	7
4	ETS Parameters.....	8
4.1	General configuration .....	9
4.1.1	Download latest database entry for this product and its User Manual from: .....	9
4.1.2	Intesis Product .....	9
4.1.3	Number of Indoor Units in ETS .....	9
4.1.4	First Status Updated to KNX.....	10
4.1.5	Enable object "Error Code [2byte]" .....	10
4.1.6	Enable object "Error Text Code [14byte]".....	10
4.2	Global mode configuration.....	11
4.2.1	Enable use of "Operating Mode" objects.....	11
4.2.2	Enable use of Mode Heat/Cool objects .....	11
4.2.3	Enable use of + / - object for Mode.....	12
4.2.4	Enable use of bit-type Mode objects (for control) .....	12
4.2.5	Enable use of bit-type Mode objects (for status) .....	13
4.2.6	Enable use of Text object for Mode.....	13
4.3	Global Fan Speed Configuration dialog.....	14
4.3.1	DPT object type for fan speed.....	14
4.3.2	Enable use of "Fan Speed Man/Auto" objects (for Control and Status) .....	15
4.3.3	Enable use of +/- object for Fan Speed.....	15
4.3.4	Enable use of bit-type Fan Speed objects (for Control) .....	16
4.3.5	Enable use of bit-type Fan Speed objects (for Status) .....	17
4.3.6	Enable use of Text object for Fan Speed .....	17
4.4	Global temperature configuration .....	18
4.4.1	Enable use of +/- obj for Setpoint.....	18
4.4.2	Ambient Ref. Temp. is provided from KNX.....	18
4.5	Control Mode configuration.....	20
4.5.1	Enable use of Control Mode objects (for Control and Status) .....	20
4.5.1	Initial state of Control Mode .....	20
4.6	Addressing of Indoor Units .....	22
4.7	License .....	23
5	Technical Specifications .....	24
6	AC Unit Types compatibility. ....	25
7	Error Codes.....	26
	Appendix A – Communication Objects Table .....	29

## 1 Presentation



INKNXHAI0--C000 allows a complete and natural integration of Haier air conditioners with KNX control systems.

Compatible with all models of VRF line of Haier air conditioners.

Main features:

- Reduced dimensions. Installation even inside the A.C. indoor unit.
- Quick and non-visible installation.
- External power not required.
- Direct connection to the KNX EIB bus.
- Direct connection to the AC indoor unit.
- Fully KNX interoperable, configuration from ETS.
- Multiple objects for control (of different types: bit, byte, characters...).
- Control of the AC unit based in the ambient temperature read by the own AC unit, or in the ambient temperature read by any KNX thermostat.
- Total Control and Monitoring of the AC unit from KNX, including monitoring of AC unit's state of internal variables, running hours counter (for filter maintenance control), and error indication and error code.
- AC unit can be controlled simultaneously by the IR remote control of the AC unit and by KNX.

## 2 Connection

### Connection of the interface to the AC indoor unit:

Disconnect mains power from the AC unit. Open the front cover of the indoor unit in order to have access to the internal control board. In the control board locate the socket connector marked as **ABG1**.

Using a 3-wire cable, connect the **ABG1** connector from the INKNXHAI0--C000 to the A B G1 connector of the AC unit's control board.

Fix the INKNXHAI0--C000 inside or outside the AC indoor unit depending on your needs – remember that INKNXHAI0--C000 must be also connected to the KNX bus. Close the AC indoor unit's front cover again.

### Connection of the interface to the KNX bus:

Disconnect power of the KNX bus. Connect the interface to the KNX TP-1 (EIB) bus using the KNX standard connector (red/grey) of the interface, respect polarity. Reconnect power of the KNX bus.

### Connections diagram:

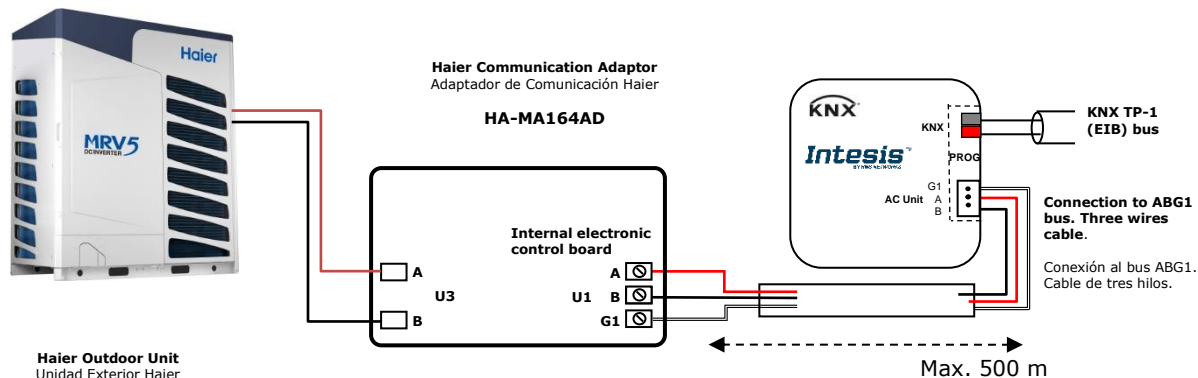

**Figure 2.1** Default parameter configuration

Each Haier Communication Adaptor connects to a single Outdoor Unit.

The INKNXHAI008C000-16-64 can be connected to more than one Haier Communication Adaptor simultaneously.

**NOTE:** More than one Haier Communication Adaptor can be present in the installation. Please make sure that the address of the Haier Communication Adaptor is correctly set in the ETS. Check section 4.6 for more information.

### 3 Configuration and setup

This is a fully compatible KNX device which must be configured and setup using standard KNX tool ETS.

ETS project for this device can be downloaded from:

<https://www.intesis.com/products/ac-interfaces/haier-gateways/haier-knx-vrf-ha-ac-knx>

Please consult the README.txt file, located inside the downloaded zip file, to find instructions on how to install the database.

## 4 ETS Parameters

When imported to the ETS software for the first time, the gateway shows the following default parameter configuration:

1.1.1 HA AC interface (multiple indoor units) > General configuration	
General configuration	Download latest database entry for this product and its User Manual from: <input type="text" value="http://www.intesisbox.com"/>
Global Mode configuration	Intesis Product: HA-AC-KNX-8
Global Fan Speed configuration	Number of Indoor Units in ETS: 1
Global Temperature configurati...	First Status Update to KNX: ASAP
Control Mode Configuration	Enable object "Error Code [2byte]": <input checked="" type="radio"/> Disabled <input type="radio"/> Enabled
Addressing of Indoor Units	Enable object "Error Text [14byte]" (2 ASCII-char Error Code): <input type="radio"/> Disabled <input checked="" type="radio"/> Enabled
License	

**Figure 4.1** Default parameter configuration

With this configuration it's possible to send On/Off (*Control\_ On/Off*), change the AC Mode (*Control\_ Mode*), the Fan Speed (*Control\_ Fan Speed*) and also the Setpoint Temperature (*Control\_ Setpoint Temperature*). The Status\_ objects, for the mentioned Control\_ objects, are also available to use if needed. Objects *Status\_ AC Ambient Reference Temperature* and *Status\_ Error/Alarm* are shown too.

1.1.1 HA AC interface (multiple indoor units)	
1:	AC01 Control_ On/Off [DPT_1.001] - 0-Off;1-On
3:	AC01 Control_ Mode [DPT_20.105] - 0-Aut;1-Hea;3-Coo;9-Fan...
11:	AC01 Control_ Fan Speed [DPT_5.001] - Thresholds: 50% an...
17:	AC01 Control_ Setpoint Temperature [DPT_9.001] - °C
24:	AC01 Status_ On/Off [DPT_1.001] - 0-Off;1-On
26:	AC01 Status_ Mode [DPT_20.105] - 0-Aut;1-Hea;3-Coo;9-Fan...
34:	AC01 Status_ Fan Speed [DPT_5.001] - 33%, 66% and 100%
40:	AC01 Status_ AC Setpoint Temperature [DPT_9.001] - °C
41:	AC01 Status_ AC Ambient Reference Temperature [DPT_9.00...
42:	AC01 Status_ Error/Alarm [DPT_1.005] - 0-No alarm;1-Alarm
44:	AC01 Status_ Error Text [DPT_16.001] - Error Text

**Figure 4.2** Default communication objects



## 4.1 General configuration

Inside this parameter's dialog it is possible to activate or change the parameters shown in the **Figure 4.1**.

### 4.1.1 Download latest database entry for this product and its User Manual from:

The first field shows the URL where to download the database and the user manual for the product.

Download latest database entry for this product and its User Manual from:

**Figure 4.3** Parameter detail

### 4.1.2 Intesis Product

This parameter is used to check, before sending the programming, the maximum number of AC units your device supports.

Global Mode configuration | Intesis Product | HA-AC-KNX-8

**Figure 4.4** Parameter detail

Select the version of the gateway that you have:

- INKNXHAI008C000, if you only want to control up to 8 AC unit.
- INKNXHAI016C000, if you only want to control up to 16 AC units.
- INKNXHAI064C000, if you only want to control up to 64 AC units.

### 4.1.3 Number of Indoor Units in ETS

This parameter is used to hide/show communication object according to the number of AC units you need to configure. Value ranges go from 1 to 64.

Number of Indoor Units in ETS

**Figure 4.5** Parameter detail

In case you introduce a number higher than the maximum number of units allowed by your license, you will get a warning message. This is just for information and will not block the configuration process. Configurations with more indoor units configured than the ones allowed by the license will not be downloaded correctly.

Intesis Product | HA-AC-KNX-8

Number of Indoor Units in ETS | 9

>> WARNING | Too many Indoor Units for this product!

**Figure 4.6** Parameter detail

#### 4.1.4 First Status Updated to KNX

This parameter defines how fast the status is updated to KNX. Depending on the value selected, more or less priority will be assigned to this action. As there are so many parameters available, it is important to consider carefully how to set this parameter.

- If set to **"ASAP"**, all status communication objects will send its value (if needed).
- If set to **"Slow"**, all status communication objects will send its value (if needed), but slower than in the previous option (ASAP).
- If set to **"Super Slow"**, all status communication objects will send its value (if needed), but slower than in the previous option (Slow).

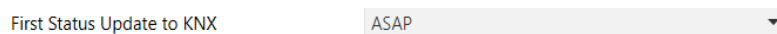

**Figure 4.7** Parameter detail

#### 4.1.5 Enable object "Error Code [2byte]"

This parameter shows/hides the *Status\_ Error Code* communication object which shows the indoor unit errors, if occurred, in numeric format.

Enable object "Error Code [2byte]"  Disabled  Enabled

43: AC01 Status\_ Error Code [2-byte signed value] - Error Code

**Figure 4.8** Communication object and parameter detail

- If set to **"Disabled"** the object will not be shown.
- If set to **"Enabled"** the *Status\_ Error Code [2byte signed value]* object will appear.
  - This object can be read and also sends the indoor unit error, if occurred, in numeric format. If a **"0"** value is shown that means no error.

#### 4.1.6 Enable object "Error Text Code [14byte]"

This parameter shows/hides the *Status\_ Error Text Code* communication object which shows the indoor unit errors, if occurred, in text format.

Enable object "Error Text [14byte]"  
(2 ASCII-char Error Code)  Disabled  Enabled

44: AC01 Status\_ Error Text [DPT\_16.001] - Error Text

**Figure 4.9** Communication object and parameter detail

- If set to **"Disabled"** the object will not be shown.
- If set to **"Enabled"** the *Status\_ Error Text Code* object will appear.

- This object can be read and also sends the indoor unit error, if occurred, in text format. The errors shown have the same format as in the remote controller and in the error list from the indoor unit manufacturer. If the object's value is empty, that means there is no error.

## 4.2 Global mode configuration

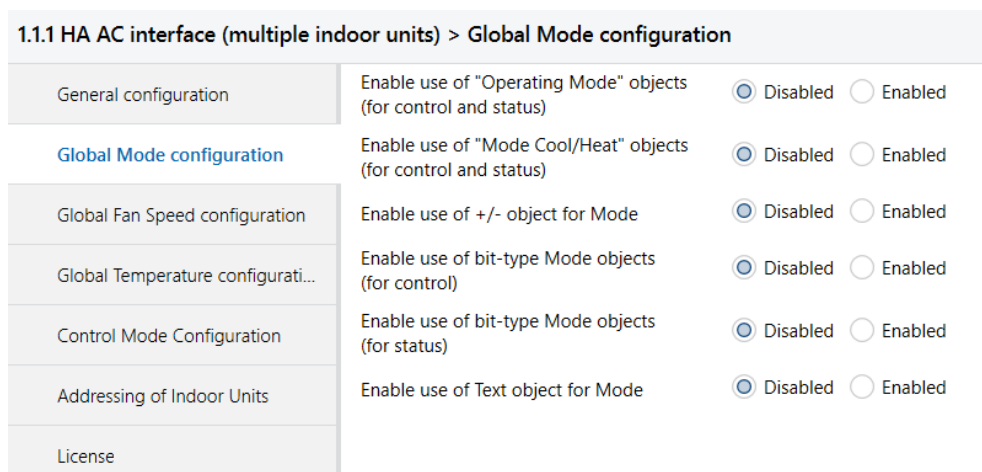

**Figure 4.10** Default Mode Configuration dialog

All the parameters in this section are related with the different mode properties and communication objects.

- ↕ 3: Control\_Mode [DPT\_20.105 - 1byte] - 0-Aut;1-Hea;3-Coo;9-Fan;14-Dry
- ↕ 26: Status\_Mode [DPT\_20.105 - 1byte] - 0-Aut;1-Hea;3-Coo;9-Fan;14-Dry

The byte-type communication object for Mode works with the DTP\_20.105. Auto mode will be enabled with a "0" value, Heat mode with a "1" value, Cool mode with a "3" value, Fan mode with a "9" value and Dry mode with a "14" value.

### 4.2.1 Enable use of "Operating Mode" objects

This parameter shows/hides the *Control\_* and *Status\_ Mode Operating Mode* communication objects.

- ↕ 2: Control\_Operating Mode [DPT\_20.102 - 1byte] - 0-Aut;1-Com;2-Stan;3-Eco;4-Pro
- ↕ 25: Status\_Operating Mode [DPT\_20.102 - 1byte] - 0-Aut;1-Com;2-Stan;3-Eco;4-

### 4.2.2 Enable use of Mode Heat/Cool objects

This parameter shows/hides the *Control\_* and *Status\_ Mode Cool/Heat* communication objects.

- ↕ 4: Control\_Mode Cool/Heat [DPT\_1.100 - 1bit] - 0-Cool;1-Heat
- ↕ 27: Status\_Mode Cool/Heat [DPT\_1.100 - 1bit] - 0-Cool;1-Heat

- If set to "Disabled" the objects will not be shown.

- If set to **“Enabled”** the *Control\_* and *Status\_ Mode Cool/Heat* objects will appear.
  - When a **“1”** value is sent to the *Control\_* communication object, **Heat mode** will be enabled in the indoor unit, and the *Status\_* object will return this value.
  - When a **“0”** value is sent to the *Control\_* communication object, **Cool mode** will be enabled in the indoor unit, and the *Status\_* object will return this value.

### 4.2.3 Enable use of + / - object for Mode

This parameter shows/hides the *Control\_ Mode +/-* communication object which let's you change the indoor unit mode by using two different datapoint types.

■ ↕ 10: Control\_ Mode +/- [DPT\_1.008 - 1bit] - 0-Up;1-Down

- If set to **“Disabled”** the object will not be shown.
- If set to **“Enabled”** the *Control\_ Mode +/-* object and a new parameter will appear.



**Figure 4.11** Parameter detail

#### ➤ DPT type for +/- Mode Object

This parameter lets choose between the datapoints **0-Up / 1-Down [DPT\_1.008]** and **0-Decrease / 1-Increase [DPT\_1.007]** for the *Control\_ Mode +/-* object.

The sequence followed when using this object is shown below:



- Up / Increase
- Down / Decrease

Keep in mind that depending on the indoor unit you have and the available features, Auto mode and Dry mode may not be present.

### 4.2.4 Enable use of bit-type Mode objects (for control)

This parameter shows/hides the bit-type *Control\_ Mode* objects.

- ↕ 5: Control\_ Mode Auto [DPT\_1.002 - 1bit] - 1-Set AUTO operating mode
- ↕ 6: Control\_ Mode Heat [DPT\_1.002 - 1bit] - 1-Set HEAT operating mode
- ↕ 7: Control\_ Mode Cool [DPT\_1.002 - 1bit] - 1-Set COOL operating mode
- ↕ 8: Control\_ Mode Fan [DPT\_1.002 - 1bit] - 1-Set FAN operating mode

▣ 9: Control\_Mode Dry [DPT\_1.002 - 1bit] - 1-Set DRY operating mode

- If set to **"no"** the objects will not be shown.
- If set to **"yes"** the *Control\_Mode* objects for Auto, Heat, Cool, Fan and Dry will appear. To activate a mode by using these objects a **"1"** value has to be sent.

#### 4.2.5 Enable use of bit-type Mode objects (for status)

This parameter shows/hides the bit-type *Status\_Mode* objects.

▣ 28: Status\_Mode Auto [DPT\_1.002 - 1bit] - 1-AUTO is active  
 ▣ 29: Status\_Mode Heat [DPT\_1.002 - 1bit] - 1-HEAT is active  
 ▣ 30: Status\_Mode Cool [DPT\_1.002 - 1bit] - 1-COOL is active  
 ▣ 31: Status\_Mode Fan [DPT\_1.002 - 1bit] - 1-FAN is active  
 ▣ 32: Status\_Mode Dry [DPT\_1.002 - 1bit] - 1-DRY is active

- If set to **"no"** the objects will not be shown.
- If set to **"yes"** the *Status\_Mode* objects for Auto, Heat, Cool, Fan and Dry will appear. When enabled, a mode will return a **"1"** through its bit-type object.

#### 4.2.6 Enable use of Text object for Mode

This parameter shows/hides the *Status\_Mode Text* communication object.

▣ 33: Status\_Mode Text [DPT\_16.001 - 14byte] - ASCII String

- If set to **"no"** the object will not be shown.
- If set to **"yes"** the *Status\_Mode Text* object will appear. Also, in the parameters, will be shown five text fields, one for each mode, that will let modify the text string displayed by the *Status\_Mode Text* when changing mode.

Enable use of Text object for Mode	<input type="radio"/> Disabled <input checked="" type="radio"/> Enabled
> String when mode is AUTO	AUTO
> String when mode is HEAT	HEAT
> String when mode is COOL	COOL
> String when mode is FAN	FAN
> String when mode is DRY	DRY

**Figure 4.12** Parameter detail

### 4.3 Global Fan Speed Configuration dialog

1.1.1 HA AC interface (multiple indoor units) > Global Fan Speed configuration		
General configuration	DPT object type for fan speed	<input checked="" type="radio"/> Scaling [DPT_5.001] <input type="radio"/> Enumerated [DPT_5.010]
Global Mode configuration	Enable use of "Fan Speed Man/Auto" objects (for control and status)	<input checked="" type="radio"/> Disabled <input type="radio"/> Enabled
Global Fan Speed configurati...	Enable use of +/- object for Fan Speed	<input checked="" type="radio"/> Disabled <input type="radio"/> Enabled
Global Temperature configurati...	Enable use of bit-type Fan Speed objects (for control)	<input checked="" type="radio"/> Disabled <input type="radio"/> Enabled
Control Mode Configuration	Enable use of bit-type Fan Speed objects (for status)	<input checked="" type="radio"/> Disabled <input type="radio"/> Enabled
Addressing of Indoor Units	Enable use of Text object for Fan Speed	<input checked="" type="radio"/> Disabled <input type="radio"/> Enabled
License		

**Figure 4.13** Default Fan Speed Configuration dialog

All the parameters in this section are related with the Fan Speed properties and communication objects.

#### 4.3.1 DPT object type for fan speed

With this parameter is possible to change de DPT for the *Control\_ Fan Speed* and *Status\_ Fan Speed* byte-type communication objects. Datapoints Scaling (DPT\_5.001) and Enumerated (DPT\_5.010) can be selected.

- When "**Enumerated [DPT 5.010]**" is selected, *Control\_ Fan Speed* and *Status\_ Fan Speed* communication objects for this DPT will appear. Also, depending on the number of fan speeds selected, these objects will be different.

- 11: AC01 Control\_ Fan Speed [DPT\_5.010] - Speed values: 1,2,3
- 34: AC01 Status\_ Fan Speed [DPT\_5.010] - Speed values: 1,2,3

The first fan speed will be selected if a "1" is sent to the *Control\_* object. The second one will be selected sending a "2", and the last one sending a "3".

The *Status\_* object will always return the value for the fan speed selected.

**⚠ Important:** If a "0" value is sent to the *Control\_* object, the minimum fan speed will be selected. If a value bigger than "3" is sent to the *Control\_* object, then the maximum fan speed will be selected.

- When "**Scaling [DPT 5.001]**" is selected, *Control\_ Fan Speed* and *Status\_ Fan Speed* communication objects for this DPT will appear. Also, depending on the number of fan speeds selected, these objects will be different.

- 11: Control\_ Fan Speed / 3 Speeds [DPT\_5.001 - 1byte] - Thresholds: 50% and 83%
- 34: Status\_ Fan Speed / 3 Speeds [DPT\_5.001 - 1byte] - 33%, 66% and 100%

When a value between **0%** and **49%** is sent to the *Control\_* object the first fan speed will be selected.

When a value between **50%** and **83%** is sent to the *Control\_* object, the second speed will be selected.

When a value between **84%** and **100%** is sent to the *Control\_* object, the third speed will be selected.

The *Status\_* object will return a **33%** when the first speed is selected, a **67%** for the second one and a **100%** for the third one.

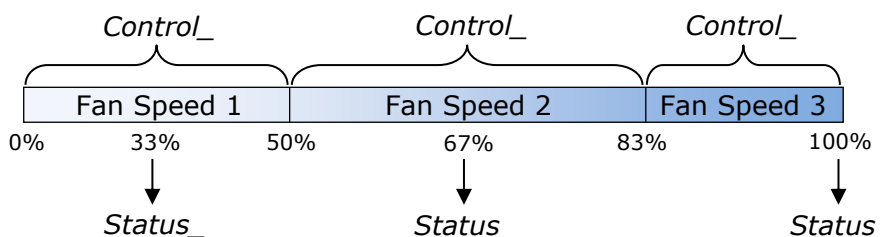

#### 4.3.2 Enable use of "Fan Speed Man/Auto" objects (for Control and Status)

This parameter shows/hides the *Control\_ Fan Speed Man/Auto and Status\_ Fan Speed Man/Auto* communication object which lets you set the Fan Speed into Manual or Auto mode.

- 12: AC01 Control\_ Fan Speed Man/Auto [DPT\_1.002] - 0-Manual...
- 35: AC01 Status\_ Fan Speed Man/Auto [DPT\_1.002] - 0-Manual;...

#### 4.3.3 Enable use of +/- object for Fan Speed

This parameter shows/hides the *Control\_ Fan Speed +/-* communication object which lets you increase/decrease the indoor unit fan speed by using two different datapoint types.

- 16: Control\_ Fan Speed +/- [DPT\_1.008 - 1bit] - 0-Up;1-Down

- If set to "no" the object will not be shown.
- If set to "yes" the *Control\_ Fan Speed +/-* object and a new parameter will appear.

Enable use of +/- object for Fan Speed  Disabled  Enabled

> Fan speed +/- operation  0-Decrease / 1-Increase [DPT\_1.007]  0-Up / 1-Down [DPT\_1.008]

> Sequence for +/- object S1 > S2 > ... > SN

Figure 4.14 Parameter detail

➤ Fan speed +/- operation

This parameter lets choose between the datapoints **0-Up / 1-Down [DPT\_1.008]** and **0-Decrease / 1-Increase [DPT\_1.007]** for the *Control\_ Fan Speed +/-* object.

➤ Sequence for +/- object

This parameter lets choose between the different modes available:

Enable use of +/- object for Fan Speed  Disabled  Enabled

> Fan speed +/- operation  0-Decrease / 1-Increase [DPT\_1.007]  0-Up / 1-Down [DPT\_1.008]

> Sequence for +/- object S1 > S2 > ... > SN

- **S1>S2>...>SN**  
Select this option if you don't have Auto mode and you don't want roll-over to be enabled.
- **S1>S2>...>SN>S1>...**  
Select this option if you don't have Auto mode and you want roll-over to be enabled.
- **Auto>S1>S2>...>SN**  
Select this option if you have Auto mode and you don't want roll-over to be enabled.
- **Auto>S1>S2>...>SN>Auto>S1>...**  
Select this option if you have Auto mode and you want roll-over to be enabled.

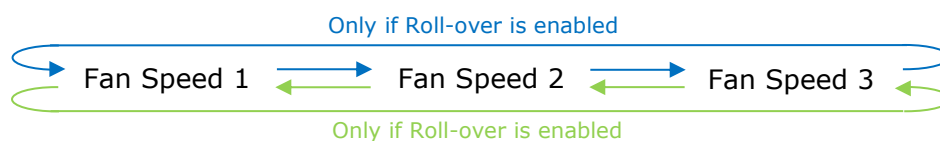

- Up / Increase
- Down / Decrease

#### 4.3.4 Enable use of bit-type Fan Speed objects (for Control)

This parameter shows/hides the bit-type *Control\_ Fan Speed* objects.

- 13: Control\_ Fan Speed 1 [DPT\_1.002 - 1bit] - 1-Set Fan Speed 1
- 14: Control\_ Fan Speed 2 [DPT\_1.002 - 1bit] - 1-Set Fan Speed 2
- 15: Control\_ Fan Speed 3 [DPT\_1.002 - 1bit] - 1-Set Fan Speed 3

- If set to "no" the objects will not be shown.
- If set to "yes" the *Control\_ Fan Speed* objects for Speed 1, Speed 2 and Speed 3 (if available) will appear. To activate a Fan Speed by using these objects a "1" value has to be sent.



### 4.3.5 Enable use of bit-type Fan Speed objects (for Status)

This parameter shows/hides the bit-type *Status\_ Fan Speed* objects.

- 36: Status\_ Fan Speed 1 [DPT\_1.002 - 1bit] - 1-Fan in speed 1
- 37: Status\_ Fan Speed 2 [DPT\_1.002 - 1bit] - 1-Fan in speed 2
- 38: Status\_ Fan Speed 3 [DPT\_1.002 - 1bit] - 1-Fan in speed 3

- If set to **"no"** the objects will not be shown.
- If set to **"yes"** the *Status\_ Fan Speed* objects for Speed 1, Speed 2 and Speed 3 (if available) will appear. When a Fan Speed is enabled, a **"1"** value is returned through its bit-type object.

### 4.3.6 Enable use of Text object for Fan Speed

This parameter shows/hides the *Status\_ Fan Speed Text* communication object.

- 39: Status\_ Fan Speed Text [DPT\_16.001 - 14byte] - ascii string

- If set to **"no"** the object will not be shown.
- If set to **"yes"** the *Status\_ Fan Speed Text* object will appear. Also, in the parameters, will be shown two (or three, depending on the number of fan speeds selected) text fields, one for each Fan Speed, that will let modify the text string displayed by the *Status\_ Fan Speed Text* when changing a fan speed.

Enable use of Text object for Fan Speed  Disabled  Enabled

> String when fan speed is AUTO	<input type="text" value="AUTO"/>
> String when fan speed is 1	<input type="text" value="SPEED 1"/>
> String when fan speed is 2	<input type="text" value="SPEED 2"/>
> String when fan speed is 3	<input type="text" value="SPEED 3"/>

**Figure 4.15** Parameter detail

### 4.4 Global temperature configuration

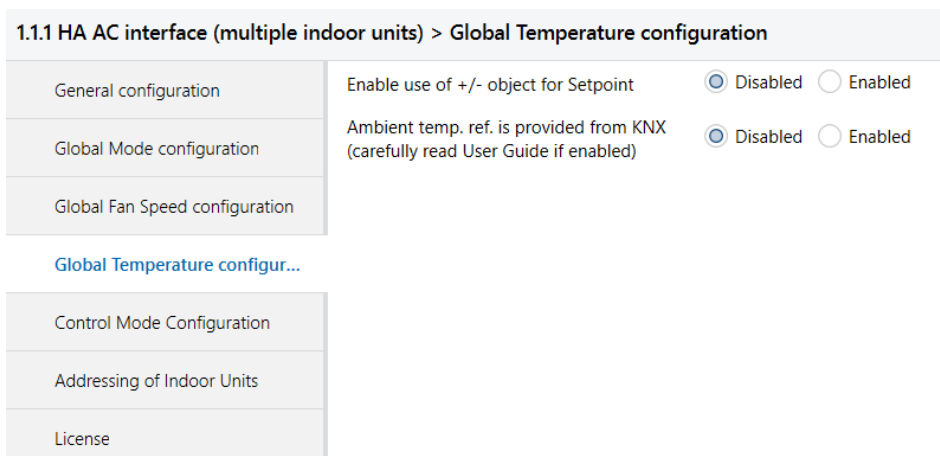

Figure 4.20 Default Temperature Configuration dialog

All the parameters in this section are related with the Temperature properties and communication objects.

#### 4.4.1 Enable use of +/- obj for Setpoint

This parameter shows/hides the *Control\_ Setpoint Temp +/-* communication object which lets you change the indoor unit setpoint temperature by using two different datapoint types.

18: Control\_ Setpoint Temp +/- [DPT\_1.008 - 1bit] - 0-Up;1-Down

- If set to "no" the object will not be shown.
- If set to "yes" the *Control\_ Setpoint Temp +/-* object and a new parameter will appear.

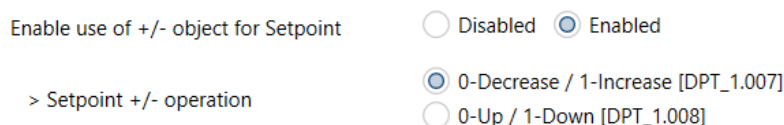

Figure 4.23 Parameter detail

➤ DPT type for +/- Setp Temp object

This parameter lets choose between the datapoints **0-Up / 1-Down [DPT\_1.008]** and **0-Decrease / 1-Increase [DPT\_1.007]** for the *Control\_ Setpoint Temp +/-* object.



- Up / Increase
- Down / Decrease

#### 4.4.2 Ambient Ref. Temp. is provided from KNX

This parameter shows/hides the *Control\_ Ambient Temperature* communication object which lets you use an ambient temperature reference provided by a KNX device.

■ 19: Control\_ Ambient Temperature [DPT\_9.001 - 2byte] - °C

- If set to **"no"** the object will not be shown.
- If set to **"yes"** the *Control\_ Ambient Temperature* object will appear. Meant to be enabled when you want the temperature provided by a KNX sensor to be the reference ambient temperature for the air conditioner. Then, the following formula applies for the calculation of real *Control\_ Setpoint Temperature* sent to the AC unit:

"AC Setp. Temp" = "Ambient ref. Temp" - ("KNX Amb. Temp." - "KNX Setp Temp.")

- AC Setp. Temp: AC indoor unit setpoint temperature
- Ambient Ref. Temp: AC indoor unit return temperature
- KNX Amb. Temp.: Ambient temperature provided from KNX
- KNX Setp. Temp: Setpoint temperature provided from KNX

As an example, consider the following situation:

User wants: **19°C** ("KNX Setp. Temp.")

User sensor (a KNX sensor) reads: **21°C** ("KNX Amb Temp.")

Ambient temp. read by Haier system is: **24°C** ("Ambient Ref. Temp")

In this example, the final setpoint temperature that INKNXHAI0--C000 will send out to the indoor unit (shown in "Setp. Temp.") will become 24°C - (21°C - 19°C) = **22°C**. This is the setpoint that will actually be requested to Haier unit.

This formula will be applied as soon as the *Control\_ Setpoint Temperature* and *Control\_ Ambient Temperature* objects are written at least once from the KNX installation. After that, they are kept always consistent.

Note that this formula will always drive the AC indoor unit demand in the *right* direction, regardless of the operation mode (Heat, Cool or Auto).

## 4.5 Control Mode configuration

Figure 4.20 Control Mode Configuration dialog

All the parameters in this section are related with the Mode properties and communication objects.

### 4.5.1 Enable use of Control Mode objects (for Control and Status)

This parameter shows/hides the *Control\_ Control Mode and Status\_ Control Mode* communication objects which lets you change the indoor unit control: No Central, LIFO (Last Input First Output), Central Controller and Lock Central Controller.

- ↕ 20: AC01 Control\_ Control Mode No Central [DPT\_1.002] - 1-Set...
- ↕ 21: AC01 Control\_ Control Mode LIFO [DPT\_1.002] - 1-Set LIFO...
- ↕ 22: AC01 Control\_ Control Mode Central [DPT\_1.002] - 1-Set CE...
- ↕ 23: AC01 Control\_ Control Mode Lock [DPT\_1.002] - 1-Set LOCK...
  
- ↕ 45: AC01 Status\_ Control Mode No Central [DPT\_1.002] - 1-NO...
- ↕ 46: AC01 Status\_ Control Mode LIFO [DPT\_1.002] - 1-LIFO mode...
- ↕ 47: AC01 Status\_ Control Mode Central [DPT\_1.002] - 1-CENTRA...
- ↕ 48: AC01 Status\_ Control Mode Lock [DPT\_1.002] - 1-LOCK mod...

- If set to **"no"** the objects will not be shown.
- If set to **"yes"** the *Control\_* and *Status\_ Control Mode* objects for No Central, LIFO (Last Input First Output), Central Controller, Lock Central Controller will appear.

### 4.5.1 Initial state of Control Mode

This parameter sets the initial value for the Control Mode: *No Central, LIFO (Last Input First Output), Central Controller, Lock Central Controller or Do not initialize.*

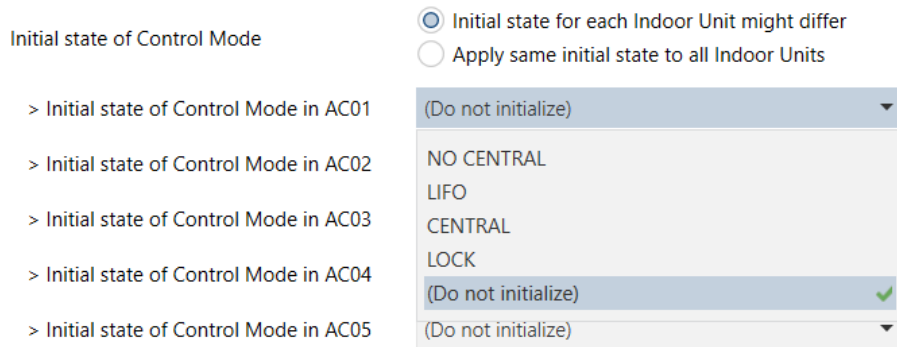

Figure 4.24 Parameter detail

- If set to **“Apply same initial state to all Indoor Units”**, the parameter option selected will apply to all indoor units.
- If set to **“Initial state for each Indoor Unit might differ”**, you will be able to set this parameter for each Indoor Unit individually.

### 4.6 Addressing of Indoor Units

1.1.1 HA AC interface (multiple indoor units) > Addressing of Indoor Units		
General configuration	----- AC01 -----	
	Modbus GW address of AC01	<input type="text" value="1"/>
Global Mode configuration	IDU index (in Modbus GW) of AC01	<input type="text" value="0"/>
Global Fan Speed configuration	----- AC02 -----	
Global Temperature configurati...	Modbus GW address of AC02	<input type="text" value="1"/>
Control Mode Configuration	IDU index (in Modbus GW) of AC02	<input type="text" value="1"/>
<b>Addressing of Indoor Units</b>	----- AC03 -----	
	Modbus GW address of AC03	<input type="text" value="1"/>
License	IDU index (in Modbus GW) of AC03	<input type="text" value="2"/>
	----- AC04 -----	
	Modbus GW address of AC04	<input type="text" value="1"/>
	IDU index (in Modbus GW) of AC04	<input type="text" value="3"/>
	----- AC05 -----	
	Modbus GW address of AC05	<input type="text" value="1"/>
	IDU index (in Modbus GW) of AC05	<input type="text" value="4"/>

Figure 4.24 Parameter detail

In this section you will be able to set the AC addressing for each AC unit present in the installation.

- **Modbus GW address of ACxx** refers to the address of the Haier Communication Adapters.
- **IDU index (in Modbus GW) of ACxx** refers to the AC system address of the Indoor Unit.

## 4.7 License

1.1.1 HA AC interface (multiple indoor units) > License

General configuration	Activation Code	<input type="text"/>
Global Mode configuration		
Global Fan Speed configuration		
Global Temperature configurati...		
Control Mode Configuration		
Addressing of Indoor Units		
<a href="#">License</a>		

**Figure 4.24** Parameter detail

Use this section to introduce the migration code in case you need to update your box from another version different from the factory default one.

## 5 Technical Specifications

Enclosure	ABS (UL 94 V-0) de 2,5 mm / 1" thick Net dimensions (dxwxh): 71 x 71 x 27 mm / 2.8" x 2.8" x 1.1" Color: White RAL 9010	Operation Temperature	0°C to +60°C
Weight	42 g.	Stock Temperature	-20°C to +85°C
Power supply	Power is supplied by: 1 x KNX bus (29V DC, 7mA)	Operational Humidity	<90% RH, non-condensing
Terminal Wiring (for low-voltage signals)	For terminal: solid wires or stranded wires (twisted or with ferrule) 1 core: 0.5mm <sup>2</sup> ... 2.5mm <sup>2</sup> 2 cores: 0.5mm <sup>2</sup> ... 1.5mm <sup>2</sup> 3 cores: not permitted	Stock Humidity	<90% RH, non-condensing
KNX port	1 x KNX TP1 (EIB) port opto-isolated. Plug-in terminal block (2 poles). TNV-1	Isolation voltage	1500 VDC
AC unit port	1 x Specific connector Plug-in terminal block (3 poles)	Isolation resistance	1000 MΩ
Configuration	Configuration with ETS	Protection	IP20 (IEC60529)
LED indicators	1 x Onboard LED - Operational status		

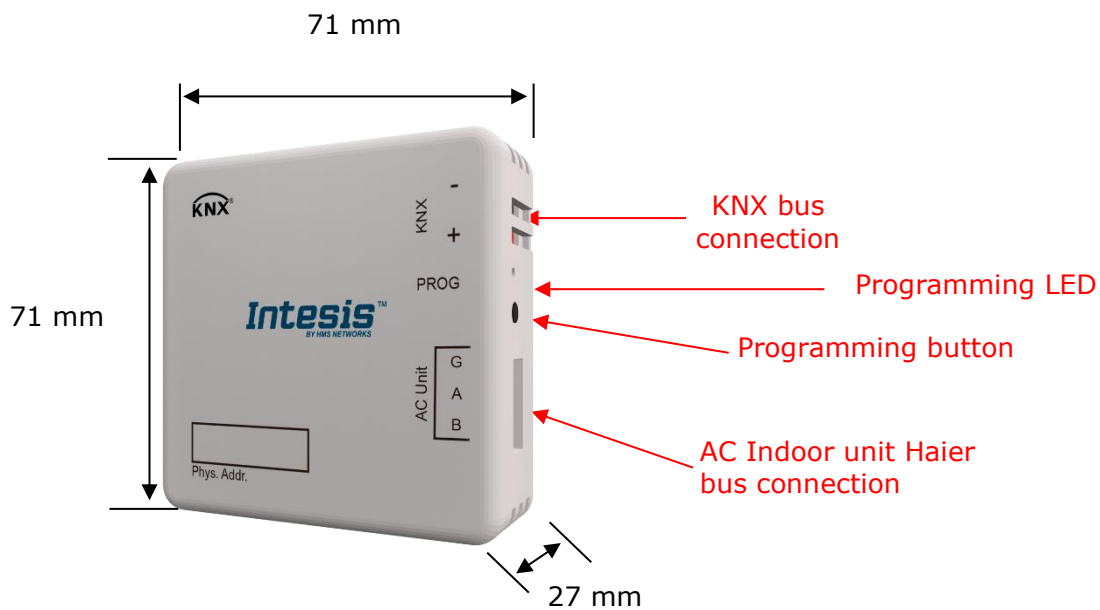



## 6 AC Unit Types compatibility.

A list of Haier indoor unit model references compatible with INKNXHAI0--C000 and their available features can be found in:

[https://www.intesis.com/docs/compatibilities/inxxxhaixxc000\\_compatibility](https://www.intesis.com/docs/compatibilities/inxxxhaixxc000_compatibility)

## 7 Error Codes

Error Code in KNX Object	Error in Remote Controller	Category	Error Name
1	1	Indoor Unit	Indoor ambient temp.sensor TA (Tas) failure
2	2		Indoor gas pipe temp. sensor TC1 failure
3	3		Indoor liquid pipe temp. sensor TC2 failure
4	4		Dual heat source sensor TW failure
5	5		Indoor EEPROM failure
6	6		Communication between indoor and outdoor failure
7	7		Communication between indoor and wired controller failure
8	8		Indoor float switch failure
9	9		Indoor address repeated failure
10	10		Reserved
11	11		Reserved
12	12		No 50 Hz zero passage signal
13	13		Coil sensor TC3 failure
14	14		DC motor failure
15	15		Indoor ambient temp.sensor TA (Taf) failure
16	16		-
17	17	-	
18	18	-	
19	19	-	
20	20	Outdoor Unit	Defrosting temp. sensor Tdef1 failure
			Defrosting temp. sensor Tdef2 failure
21	21		Ambient temp. sensor Ta failure
22	22		Suction temp. sensor Ts1 failure
			Suction temp. sensor Ts2 failure
			Suction temp. sensor Tsacc failure
			Suction temp. sensor Tsuc failure
23	23		Discharging temp. sensor Tdi failure
			Discharging temp. sensor Td1 failure
			Discharging temp. sensor Td2 failure
24	24		Oil temp. sensor Toilp failure
			Oil temp. sensor Toil failure
25	25		Inlet temp. of heat exchanger Toci1 failure
			Inlet temp. of heat exchanger Toci2 failure
26	26		indoor communication failure
			Reduce the number of indoor units failure
			Increase the number of indoor units failure
27	27		Oil temp. too high protection (Toil)
			Oil temp. too high protection (Toi2)
28	28		High pressure sensor Pd1 failure
			High pressure sensor Pd2 failure
29	29		Low pressure sensor Ps failure
30	30		High pressure switch HPSi failure
			High pressure switch HPS1 failure
		High pressure switch HPS2 failure	
31	31	Liquid pipe pressure PI failure	
32	32	Outlet temp. of subcooler Tsc0 failure	
		Liquid pipe SC temp. of subcooler Tliqsc failure	
33	33	EEPROM (AT24C04) failure	
34	34	Discharging temp. too high protection (Tdi)	
		Discharging temp. too high protection (Td1)	
		Discharging temp. too high protection (Td2)	
35	35	4-way valve reversing failure	
		4-way valve reversing failure	
36	36	Oil temp. too low protection (Toil)	
		Oil temp. too low protection (Toi2)	
37	37	Lack of phase of 3N power supply or wrong phase sequence	
38	38	High pressure sensor Pd too low protection	
39	39	Low pressure sensor Ps too low protection	
		Compression ratio too high protection	
		Compression 1 ratio too low protection	
		Compression 2 ratio too low protection	
40	40	High pressure sensor Pd1 too high protection	
		High pressure sensor Pd2 too high protection	
41	41	Water temp. Twi too low protection	
		Water temp. Twi too high protection	
42	42	Frost protection of water system	
		Water system out of water freeze protection	
		Water flow of Water system is too small to protect	
43	43	Discharging temp. sensor Tdi too low protection	
		Discharging temp. sensor Td1 too low protection	
		Discharging temp. sensor Td2 too low protection	

44	44	Low pressure sensor PS too high protection
45	45	Communication among outdoors failure
46	44	Communication with inverter board 1 failure
47	47	Communication with inverter board 2 failure
48	48	-
49	49	Unloading valve SV1 failure
50	50	-
51	51	-
52	52	-
53	53	Current detector CT1 failure
54	54	Communication with Thermal storage module failure
55	55	Thermal storage module LEV failure
56	56	Thermal storage module too hot failure
57	57	Communication between Thermal storage module and host computer
58	58	Thermal storage module Tc1 temp. sensor failure
59	59	Thermal storage module Tc2 temp. sensor failure
60	60	Reserved
61	61	Reserved
62	62	Reserved
63	63	Thermal storage module DIP setting failure
64	64	CT1 over current
65	65	CT2 over current
66	66	-
67	67	-
68	68	Communication with motor driving board failure
69	69	-
70	70	-
71	71	Left DC motor blocked
72	72	Right DC motor blocked
73	73	Left DC motor reversed
74	74	Right DC motor reversed
75	75	Left DC motor current too high
76	76	Right DC motor current too high
77	77	-
78	78	No pressure drop between high pressure and low one
79	79	Pressure too low between high pressure and low one
80	80	Incorrect outdoor address or capacity setting
81	81	Oil equalization protection among outdoors
82	82	Lack of refrigerant in cooling
83	83	Lack of refrigerant in heating
84	84	Incorrect wiring
85	85	Indoor and outdoor do not match
86	86	Model temp. too high protection
87	87	Compressor current protection
88	88	Wrong model selection
89	89	-
90	90	-
91	91	-
92	92	-
93	93	-
94	94	-
95	95	-
96	96	-
97	97	-
98	98	-
99	99	Program self-test failure
100	100	DC motor driving board IPM alarm
101	101	DC motor driving board detecting out of control
102	102	DC motor driving board EEPROM faulty
103	103	DC motor driving board over current or current detector damaged
104	104	Voltage too low protection of DC motor driving board
105	105	Voltage too high protection of DC motor driving board
106	106	DC motor driving board blocked
107	107	Protection of motor rate over Limitation
108	108	-
109	109	-
110	110	model 1 Over current
		model 2 Over current

111	111		Compressor 1 out of control Compressor 2 out of control
112	112		Radiator of model 1 temp. too high Radiator of model 2 temp. too high
113	113		model 1 overload model 2 overload
114	114		Voltage too low of model 1 Voltage too low of model 2
115	115		Voltage too high of model 1 Voltage too high of model 2
116	116		Communication abnormal with model 1 Communication abnormal with model 2
117	117		Model 1 Over current (software) Model 1 Over current (software)
118	118		Model 1 startup failure Model 2 startup failure
119	119		Current Detecting Circuit Abnormal of transducer 1 Current Detecting Circuit Abnormal of transducer 2
120	120		Power supply of transducer 1 abnormal Power supply of transducer 2 abnormal
121	121		Power supply of inverter board 1 is abnormal Power supply of inverter board 2 is abnormal
122	122		Radiator temp. sensor of transducer 1 abnormal Radiator temp. sensor of transducer 2 abnormal
123	123		-
124	124		-
125	125		Compressor 1 frequency not match Compressor 2 frequency not match
126	126		-
127	127		MCU reset abnormal
128	128		MCU Program needs to be upgraded
0	N/A	KNX interface	No error
65535 (-1)	N/A	KNX interface	Indoor Units not ready for communication
65436 (-100)	N/A	KNX interface	License Error / indoor unit not supported by current license
65336 (-200)	N/A	KNX interface	Overconsumption error in EXY bus

In case you detect an error code not listed, contact your nearest Haier technical support service for more information on the error meaning.

## Appendix A – Communication Objects Table

SECTION	OBJECT NUMBER	NAME	LENGTH	DATAPOINT TYPE		FLAGS				FUNCTION
				DPT_NAME	DPT_ID	R	W	T	U	
On/Off	1	Control_ On/Off	1 bit	DPT_Switch	1.001		W	T		0 - Off; 1-On
Mode	2	Control_ Operating Mode	1 byte	DPT_HVACMode	20.102		W	T		0 - Auto; 1 - Com; 2 - Stan; 3 - Eco; 4 - Pro
	3	Control_ Mode	1 byte	DPT_HVACControl	20.105		W	T		0 - Auto; 1 - Heat; 3 - Cool; 9 - Fan; 14 - Dry
	4	Control_ Mode Cool/Heat	1 bit	DPT_Cool/Heat	1.100		W	T		0 - Cool; 1 - Heat
	5	Control_ Mode Auto	1 byte	DPT_Scaling	5.001		W	T		1 - Auto
	6	Control_ Mode Heat	1 byte	DPT_Scaling	5.001		W	T		1 - Heat
	7	Control_ Mode Cool	1 bit	DPT_Bool	1.002		W	T		1 - Cool
	8	Control_ Mode Fan	1 bit	DPT_Bool	1.002		W	T		1 - Dry
	9	Control_ Mode Dry	1 bit	DPT_Bool	1.002		W	T		1 - Fan
	10	Control_ Mode +/-	1 bit	DPT_Step	1.007		W			0 - Decrease; 1 - Increase
		Control_ Mode +/-	1 bit	DPT_UpDown	1.008		W			0 - Up; 1 - Down
Fan Speed	11	Control_ Fan Speed / 3 Speeds	1 byte	DPT_Scaling	5.001		W	T		0%-49% - Speed 1; 50%-83% - Speed 2; 84%-100% Speed 3
		Control_ Fan Speed / 3 Speeds	1 byte	DPT_Enumerated	5.010		W	T		1 - Speed 1; 2 - Speed 2; 3 Speed 3
	12	Control_ Fan Speed Man/Auto	1 bit	DPT_Bool	1.002		W	T		0 - Manual; 1 - Auto
	13	Control_ Fan Speed 1	1 bit	DPT_Bool	1.002		W	T		1 - Fan Speed 1
	14	Control_ Fan Speed 2	1 bit	DPT_Bool	1.002		W	T		1 - Fan Speed 2
	15	Control_ Fan Speed 3	1 bit	DPT_Bool	1.002		W	T		1 - Fan Speed 3
	16	Control_ Fan Speed +/-	1 bit	DPT_Step	1.007		W	T		0 - Decrease; 1 - Increase
		Control_ Fan Speed +/-	1 bit	DPT_UpDown	1.008		W	T		0 - Up; 1 - Down

Temperature	17	Control_ Setpoint Temperature	2 byte	DPT_Value_Temp	9.001		W	T	17°C to 30°C
	18	Control_ Setpoint Temp +/-	1 bit	DPT_Step	1.007		W		0 - Decrease; 1 - Increase
		Control_ Setpoint Temp +/-	1 bit	DPT_UpDown	1.008		W		0 - Up; 1 - Down
Control Mode	19	Control_ Ambient Temperature	2 byte	DPT_Value_Temp	9.001		W	T	°C value in EIS5 format
	20	Control_ Control Mode No Central	1 bit	DPT_Bool	1.002		W	T	1 - No Central Controller
	21	Control_ Control Mode LIFO	1 bit	DPT_Bool	1.002		W	T	1 - Last Input First Output (LIFO)
	22	Control_ Control Mode Central	1 bit	DPT_Bool	1.002		W	T	1 - Central Controller
	23	Control_ Control Mode Lock	1 bit	DPT_Bool	1.002		W	T	1 - Lock Central Controller

On/Off	24	Status_ On/Off	1 bit	DPT_Switch	1.001	R		T	0 - Off; 1-On
Mode	25	Status_ Operating Mode	1 byte	DPT_HVACMode	20.102	R		T	0 - Auto; 1 - Com; 2 - Stan; 3 - Eco; 4 - Pro
	26	Status_ Mode	1 byte	DPT_HVACContrMode	20.105	R		T	0 - Auto; 1 - Heat; 3 - Cool; 9 - Fan; 14 - Dry
	27	Status_ Mode Cool/Heat	1 bit	DPT_Heat/Cool	1.100	R		T	0 - Cool; 1 - Heat
	28	Status_ Mode Auto	1 bit	DPT_Bool	1.002	R		T	1 - Auto
	29	Status_ Mode Heat	1 bit	DPT_Bool	1.002	R		T	1 - Heat
	30	Status_ Mode Cool	1 bit	DPT_Bool	1.002	R		T	1 - Cool
	31	Status_ Mode Fan	1 bit	DPT_Bool	1.002	R		T	1 - Fan
	32	Status_ Mode Dry	1 bit	DPT_Bool	1.002	R		T	1 - Dry
	33	Status_ Mode Text	14 byte	DPT_String_8859_1	16.001	R		T	ASCII String
Fan Speed	34	Status_ Fan Speed / 3 Speeds	1 byte	DPT_Scaling	5.001	R		T	33% - Speed 1; 67% - Speed 2; 100% - Speed 3
		Status_ Fan Speed / 3 Speeds	1 byte	DPT_Enumerated	5.010	R		T	1 - Speed 1; 2 - Speed 2; 3 - Speed 3
	35	Status_ Fan Speed Man/Auto	1 bit	DPT_Bool	1.002	R		T	0 - Manual; 1 - Auto