

# Samsung NASA compatible Outdoor Units

Gateway for the integration of Samsung NASA compatible systems  
into KNX home automation systems

## USER MANUAL

Issue date: 03/2021 r1.2 ENGLISH



## Important User Information

### Disclaimer

The information in this document is for informational purposes only. Please inform HMS Industrial Networks of any inaccuracies or omissions found in this document. HMS Industrial Networks disclaims any responsibility or liability for any errors that may appear in this document.

HMS Industrial Networks reserves the right to modify its products in line with its policy of continuous product development. The information in this document shall therefore not be construed as a commitment on the part of HMS Industrial Networks and is subject to change without notice. HMS Industrial Networks makes no commitment to update or keep current the information in this document.

The data, examples and illustrations found in this document are included for illustrative purposes and are only intended to help improve understanding of the functionality and handling of the product. In view of the wide range of possible applications of the product, and because of the many variables and requirements associated with any particular implementation, HMS Industrial Networks cannot assume responsibility or liability for actual use based on the data, examples or illustrations included in this document nor for any damages incurred during installation of the product. Those responsible for the use of the product must acquire sufficient knowledge in order to ensure that the product is used correctly in their specific application and that the application meets all performance and safety requirements including any applicable laws, regulations, codes and standards. Further, HMS Industrial Networks will under no circumstances assume liability or responsibility for any problems that may arise as a result from the use of undocumented features or functional side effects found outside the documented scope of the product. The effects caused by any direct or indirect use of such aspects of the product are undefined and may include e.g. compatibility issues and stability issues.

Gateway for the integration of Samsung NASA compatible systems into KNX home automation systems.

<b>ORDER CODE</b>	<b>LEGACY ORDER CODE</b>
INKNXSAM004O000	SM-ACN-KNX-4
INKNXSAM008O000	SM-ACN-KNX-8
INKNXSAM016O000	SM-ACN-KNX-16
INKNXSAM064O000	SM-ACN-KNX-64

## INDEX

1	Description .....	5
1.1	Introduction.....	5
1.1	Functionality.....	6
1.2	Capacity of Intesis .....	7
2	KNX System.....	8
2.1	Description.....	8
2.2	Points definition .....	8
3	Connections .....	10
3.1	Power device .....	11
3.2	Connect to Samsung NASA installation.....	11
3.3	Connection to KNX.....	11
3.4	Connection to the configuration tool.....	11
4	Set-up process and troubleshooting .....	12
4.1	Pre-requisites .....	12
4.2	Intesis MAPS. Configuration & monitoring tool for Intesis KNX series .....	12
4.2.1	Introduction .....	12
4.2.2	Connection.....	12
4.2.3	Configuration tab .....	13
4.2.4	KNX configuration.....	13
4.2.5	Samsung NASA configuration .....	15
4.2.6	Signals .....	17
4.2.7	Sending the configuration to Intesis .....	18
4.2.8	Diagnostic .....	18
4.2.9	Set-up procedure.....	20
5	Electrical & Mechanical Features.....	21
6	Dimensions .....	22
7	AC Unit Types compatibility .....	23
8	Error codes for Indoor and Outdoor Units.....	24
9	Appendix A – Communication Objects Table .....	28

## 1 Description

### 1.1 Introduction

This document describes the integration of Samsung NASA compatible air conditioning systems into KNX home automation systems using gateway *Intesis KNX – Samsung NASA*.

The aim of this integration is to monitor and control your Samsung NASA air conditioning system, from your KNX TP-1 installation. To do it so, Intesis performs as a more KNX device, sending and receiving telegrams to group addresses in the KNX network.

Intesis makes available the Samsung NASA air conditioning system indoor units' datapoints through independent KNX objects.

Up to 64 indoor units supported, depending on product version.

This document assumes that the user is familiar with KNX and Samsung technologies and their technical terms.

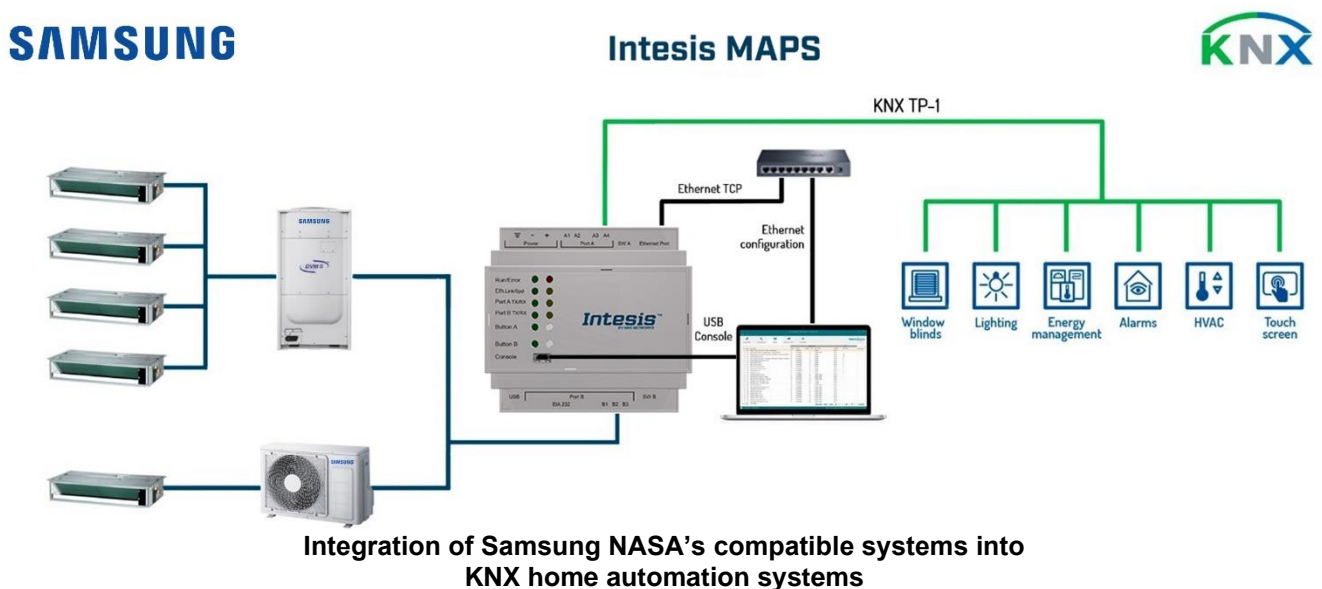

**NOTE:** Take following considerations into account for Samsung's NASA R1/R2 network:



- Samsung NASA AC network allows for both automatic and manual addressing. **Manual addressing of both indoor and outdoor units must be setup by Samsung installer in order that Intesis communicates properly.** Manual addressing is setup by means of DIP switches in outdoor unit, and using the remote controller or DIP switches in the indoor unit.
- Samsung NASA indoor units **need to be configured to accept 'central control'**. To do so, they need to be configured with so-called 'installation option code' in which segment 5 of this code needs to be set to value '1' to allow central control.

## 1.1 Functionality

Intesis™ continuously monitors Samsung's NASA R1/R2 network for all configured signals and keeps the updated status of all of them in its memory. It triggers updates on configured group addresses to KNX network on value change.

Commands toward the R1/R2 indoor unit communication adaptor are permitted.

Each indoor unit is offered as a set of KNX objects.

Element	Object supported
Outdoor Unit	<ul style="list-style-type: none"><li>• Communication status</li><li>• Addressing status</li></ul>
Indoor Unit	<ul style="list-style-type: none"><li>• Status</li><li>• Command</li><li>• Communication status</li></ul>
General signals (all units)	<ul style="list-style-type: none"><li>• Command</li></ul>

## 1.2 Capacity of Intesis

Element	Max.	Notes
Number of indoor units	64 *	Number of indoor units that can be controlled through Intesis
Number of Objects	3904 *	Number of Samsung NASA objects available into Intesis.

\* There are different models of *Intesis KNX – Samsung NASA AC* each one with different capacity. The table above shows the capacity for the top model (with maximum capacity).

Their order codes are:

- INKNXSAM004O000: Model supporting up to 4 indoor units
- INKNXSAM008O000: Model supporting up to 8 indoor units
- INKNXSAM016O000: Model supporting up to 16 indoor units
- INKNXSAM064O000: Model supporting up to 64 indoor units

## 2 KNX System

In this section, a common description for all Intesis KNX series gateways is given, from the point of view of KNX system which is called from now on *internal system*. Connection with the Samsung NASA R1/R2 system is also called from now on *external system*.

### 2.1 Description

Intesis KNX connects directly to the KNX TP-1 bus and performs as one more device into the KNX system, with the same configuration and operational characteristics as other KNX devices.

Internally, the circuit part connected to the KNX bus is opto-isolated from the rest of the electronics.

*Intesis KNX* receives, manages and sends all the telegrams related to its configuration to the KNX bus.

On receiving WRITE telegrams of KNX group addresses associated to communication objects, the corresponding messages are sent to the external system (Samsung NASA installation).

When a change in a signal of the external system is detected, a WRITE telegram is sent to the KNX bus (addressed with the group address associated to the corresponding group object), in order to maintain both systems synchronised in every moment.

The status of the KNX bus is checked continuously and, if a bus drop-down is detected, for example due to failure in the bus power supply, after the KNX bus is restored again, Intesis will send READ telegrams to group addresses of all communication objects marked with flag 'Ri'. The behaviour of each individual point into Intesis is determined by the flags configured for the communication object. See details below.

### 2.2 Points definition

Every group object in configuration has following KNX properties:

Property	Description
<b>Description</b>	Descriptive information about the communication object or signal.
<b>Object function</b>	Information on range of values for the group object.
<b>DPT</b>	Datapoint type. It is the KNX data type used to encode the signal's value. It will depend on the type of signal associated in the external system in every case.
<b>Group</b>	It is the KNX group to which the point is associated. It is also the group to which the read (R), write (W), transmit (T), update (U) and read on init (Ri) flags are applied. It is the sending group.
<b>Listening addresses</b>	They are the addresses that can write on the group object, apart of the main group address.
<b>R</b>	Read. If this flag is activated, READ telegrams of this group address will be accepted.
<b>Ri</b>	Read on Init. If this flag is activated, the object will trigger corresponding READ request (on associated group address) on initialization.
<b>W</b>	Write. If this flag is activated, WRITE telegrams on this group object will be accepted.
<b>T</b>	Transmit. If this flag is activated, when the group object value changes, due to a change in the external system, a WRITE telegram of the associated group address will be sent to the KNX bus.
<b>U</b>	Update. If this flag is activated, UPDATE telegrams (response to READ telegrams) on this group object will be accepted.
<b>Active</b>	If activated, the point will be active in Intesis, if not, the behaviour will be as if the point is not defined. This allows deactivating points without the need of delete them for possible future use.



These properties are common for all Intesis KNX series gateways. Although each integration may have specific properties according to the type of signals of the external system.

See list of communication objects, according to unit type in section 9

### 3 Connections

Find below information regarding the Intesis connections available.

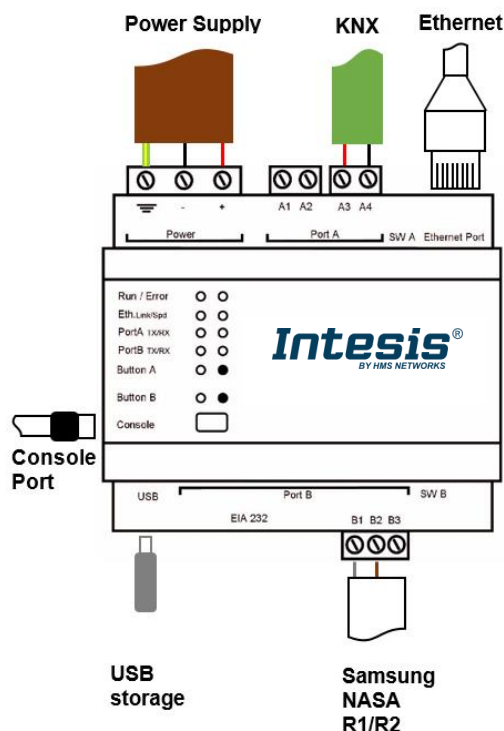

#### Power Supply

Must use NEC Class 2 or Limited Power Source (LPS) and SELV rated power supply.

#### If using DC power supply:

Respect polarity applied of terminals (+) and (-). Be sure the voltage applied is within the range admitted (check table below). The power supply can be connected to earth but only through the negative terminal, never through the positive terminal.

#### If using AC power supply:

Make sure the voltage applied is of the value admitted (24 Vac). Do not connect any of the terminals of the AC power supply to earth, and make sure the same power supply is not supplying any other device.

#### Ethernet

Connect the cable coming from the IP network to the connector ETH of the gateway. Use an Ethernet CAT5 cable. If communicating through the LAN of the building, contact the network administrator and make sure traffic on the port used is allowed through all the LAN path (check the gateway user manual for more information). Default IP is 192.168.100.246. DHCP is enabled by default.

#### PortA / KNX

Connect the KNX TP1 bus to connectors A3 (+) and A4 (-) of gateway's PortA. Respect the polarity.

#### PortB / R1/R2 Samsung NASA

Connect the R1 (+) R2 (-) bus of Samsung NASA Outdoor Units to the connectors B1 (-), B2 (+) of gateway's PortB. Respect the polarity.

#### Console Port

Connect a mini-type B USB cable from your computer to the gateway to allow communication between the Configuration Software and the gateway. Remember that Ethernet connection is also allowed. Check the user manual for more information.

#### USB

Connect a USB storage device (not a HDD) if required. Check the user manual for more information.

Ensure proper space for all connectors when mounted (see section 6)

### 3.1 Power device

The first step to perform is to power up the device. To do so, a power supply working with any of the voltage range allowed is needed (check section 5). Once connected the ON led will turn on.

**WARNING!** In order to avoid earth loops that can damage the gateway and/or any other equipment connected to it, we strongly recommend:

- The use of DC power supplies, floating or with the negative terminal connected to earth. **Never use a DC power supply with the positive terminal connected to earth.**
- The use of AC power supplies only if they are floating and not powering any other device.

### 3.2 Connect to Samsung NASA installation

Use the Port B connector in the top corner of the Intesis device in order to connect Samsung NASA bus to the Intesis. Remember to follow all safety precautions indicated by Samsung.

To properly communicate with the Intesis, take into account following considerations:

- Samsung NASA AC network allows for both automatic and manual addressing. **Manual addressing of both indoor and outdoor units must be setup by Samsung installer in order that Intesis communicates properly.** Manual addressing is setup by means of DIP switches in outdoor unit, and using the remote controller or DIP switches in the indoor unit.
- Samsung NASA indoor units **need to be configured to accept 'central control'**. To do so, they need to be configured with so-called 'installation option code' in which segment 5 of this code needs to be set to value '1' to allow central control.

Connect the Samsung NASA bus to connectors B1 (R1/+) and B2 (R2/-) of gateway's PortB. Respect the polarity.

### 3.3 Connection to KNX

Connect the KNX TP1 bus to connectors A3 (+) and A4 (-) of gateway's PortA. Respect the polarity.

### 3.4 Connection to the configuration tool

This action allows the user to have access to configuration and monitoring of the device (more information can be found in the configuration tool User Manual). Two methods to connect to the PC can be used:

- **Ethernet:** Using the Ethernet port of Intesis.
- **USB:** Using the console port of Intesis, connect a USB cable from the console port to the PC.

## 4 Set-up process and troubleshooting

### 4.1 Pre-requisites

It is necessary to have a KNX installation, device or interface operative and well connected to the corresponding KNX port of Intesis. It is also required to have a Samsung NASA Air Conditioner installation, with accessible R1/R2 port for connection of Intesis.

Connectors, connection cables, PC to use the configuration tool and other auxiliary material, if needed, are not supplied by HMS Industrial Networks SLU for this standard integration.

Items supplied by HMS Networks for this integration are:

- Intesis gateway.
- Link to download the configuration tool.
- USB Console cable to communicate with Intesis.
- Product documentation.

### 4.2 Intesis MAPS. Configuration & monitoring tool for Intesis KNX series

#### 4.2.1 Introduction

Intesis MAPS is a Windows® compatible software developed specifically to monitor and configure Intesis new generation gateways.

The installation procedure and main functions are explained in the *Intesis MAPS KNX User Manual*. This document can be downloaded from the link indicated in the installation sheet supplied with the Intesis device or in the product website at [www.intesis.com](http://www.intesis.com)

In this section, only the specific case of Samsung NASA to KNX systems will be covered.

Please check the Intesis MAPS KNX User Manual for specific information about the different parameters and how to configure them.

#### 4.2.2 Connection

To configure the Intesis connection parameters press on the **Connection** button in the *menu bar*.

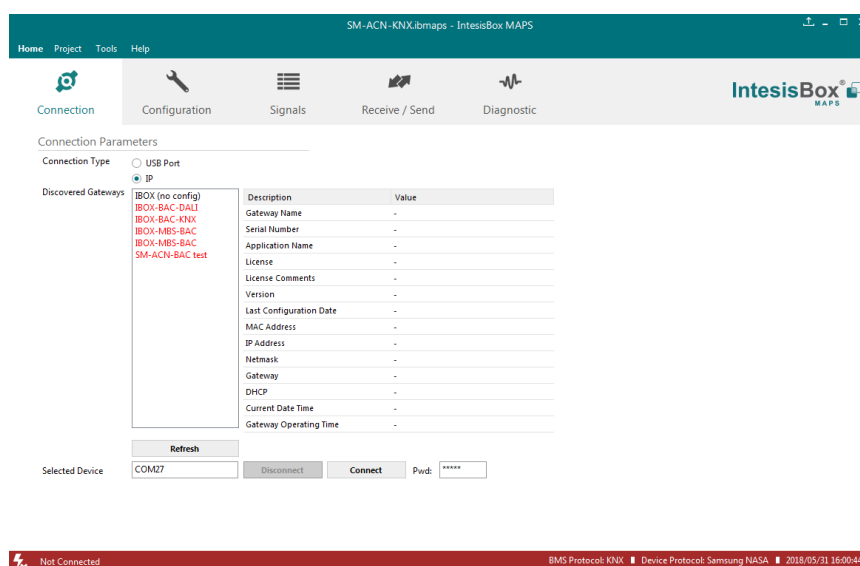

Figure 4.1 MAPS connection

### 4.2.3 Configuration tab

Select the **Configuration** tab to configure the connection parameters. Three subsets of information are shown in this window: General (Gateway general parameters), KNX (KNX interface configuration) and Samsung NASA (Samsung NASA interface parameters).

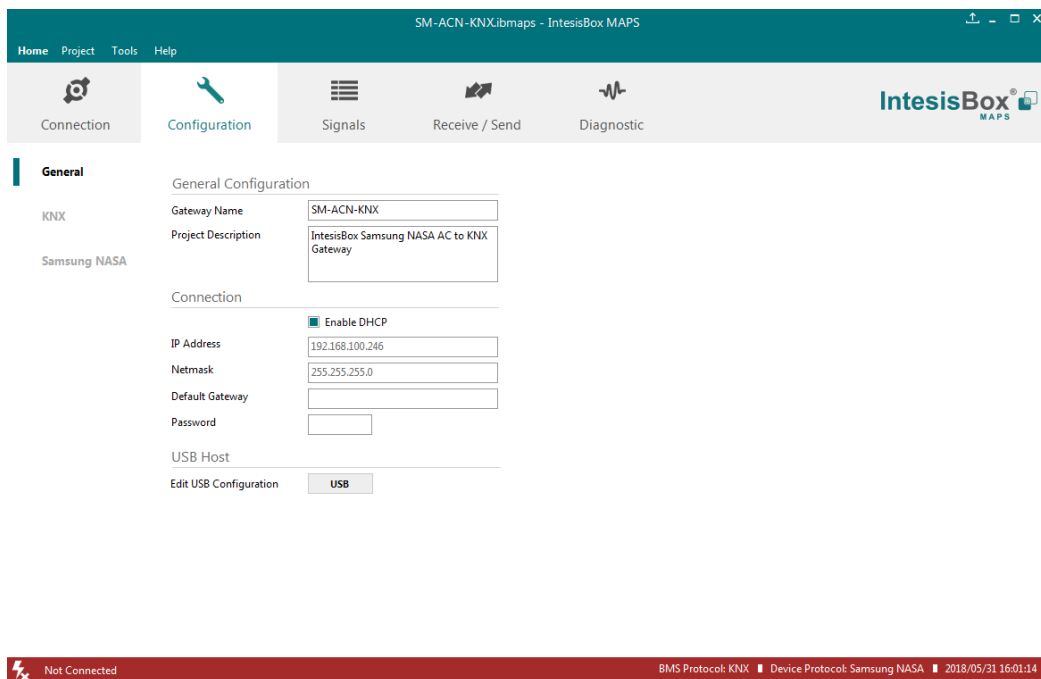

Figure 4.2 Intesis MAPS configuration tab

### 4.2.4 KNX configuration

Set parameters of KNX interface of Intesis.

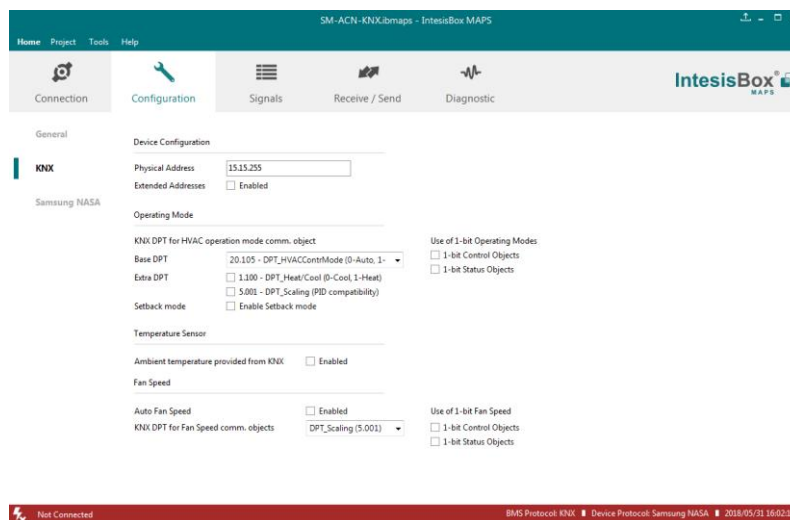

Figure 4.3 Intesis MAPS KNX configuration tab

#### 1. Device configuration

**1.1. Physical Address.** KNX physical address of the device in the network

**1.2. Extended Addresses.** Enables usage of KNX Extended addresses (ranging from 16/0/0 to 32/7/255).

## 2. Operating Mode. Settings related to KNX interface for control and feedback of AC unit's operating mode.

**2.1. KNX DPT for HVAC operation mode comm object. Base DPT.** Base DPT to use for control/monitor the operating mode. Following DPT types are offered:

- DPT\_20.105. DPT\_HVACContrMode: 0-Auto, 1-Heat, 3-Cool, 9-Fan, 14-Dry
- DPT\_5.x (non-standardized): 0-Auto, 1-Heat, 2-Dry, 3-Fan, 4-Cool, 5-Setback (if enabled)

**2.2. KNX DPT for HVAC operation mode comm object. Extra DPT.** Additional DPT to use for control/monitor the operating mode.

- DPT\_1.100. DPT\_Heat/Cool: 0-Cool, 1-Heat.
- DPT\_5.001. DPT\_Scaling: Enables objects "Control\_Heat Mode & On" and "Control\_Cool Mode & On" at IC/FU unit types. Their type is DPT\_Scaling (0..100%), and their ending is to be able to control parameters On/Off, Cool/Heat indoor unit from a single percentage object. They are meant to provide compatibility with certain thermostats oriented to the operation of valves for Heating/Cooling. Whenever a value > 0% is received at each of these two objects, the corresponding operating mode and ON operation is sent to the indoor unit. Whenever both values are 0%, indoor unit is set to OFF

**2.3. Use of 1-bit Operating Modes. 1-bit Control Objects.** Enables a bit-type object for the control of each operating mode.

**2.4. Use of 1-bit Operating Modes. 1-bit Status Objects.** Enables a bit-type object for monitoring each operating mode.

## 3. Temperature Sensor.

**3.1. Ambient temperature provided from KNX.** Enables object Control\_KNX ambient temperature.



**NOTE:** Indoor unit does not accept, by itself, that an ambient temperature for control of operation of the indoor unit is provided. To allow regulation of indoor unit according to a temperature reference from KNX, what Intesis does is passing a different temperature setpoint to the indoor unit than the one required by the user. The passed setpoint is such that the difference 'Ambient temperature reported by Samsung NASA – AC setpoint' is equal to 'Ambient temperature reported by KNX – AC setpoint required by KNX', using the following formula:

$$\text{"AC Setp. Temp"} = \text{"AC Ret. Temp"} - (\text{"KNX Amb. Temp."} - \text{"KNX Setp. Temp"})$$

Where:

- AC Setp. Temp: AC indoor unit setpoint temperature
- AC Ret. Temp: AC indoor unit return temperature
- KNX Amb. Temp.: Ambient temperature provided from KNX
- KNX Setp. Temp: Setpoint temperature provided from KNX

Consequently, when using this feature (Ambient temp provided from KNX), setpoint at AC and setpoint in KNX will not necessarily be the same (actually, user will not be able to operate setpoint from AC System controllers as the remote controller).

## 4. Fan Speed. Settings related to KNX interface for control and feedback of AC unit's fan speed.

**4.1. Auto Fan Speed.** Configures availability of Auto Fan Speed control/monitoring objects. Necessary if your indoor unit has auto fan speed.

**4.2. KNX DPT for Fan Speed comm objects. DPT\_5.001, DPT\_Scaling.** Control/monitoring of Fan Speed is performed by means of scaling (percentage) objects. Thresholds for control object and values for status object will vary according to number of fanspeeds of the unit.

**4.2. KNX DPT for Fan Speed comm objects. DPT\_5.010, DPT\_Value\_1\_Ucount.** Control/monitoring of Fan Speed is performed by means of enumerated values.

**4.3. KNX DPT for Fan Speed comm objects. DPT\_5.010, DPT\_Value\_1\_Ucount.** Control/monitoring of Fan Speed is performed by means of enumerated values.

**4.4. Use of 1-bit Fan Speed. 1-bit Control Objects.** Enables a bit-type object for control of fan speed.

**4.5. Use of 1-bit Fan Speed. 1-bit Status Objects.** Enables a bit-type object for monitoring of each fan speed.

#### 4.2.5 Samsung NASA configuration

Set parameters for connection with Samsung NASA's installation.

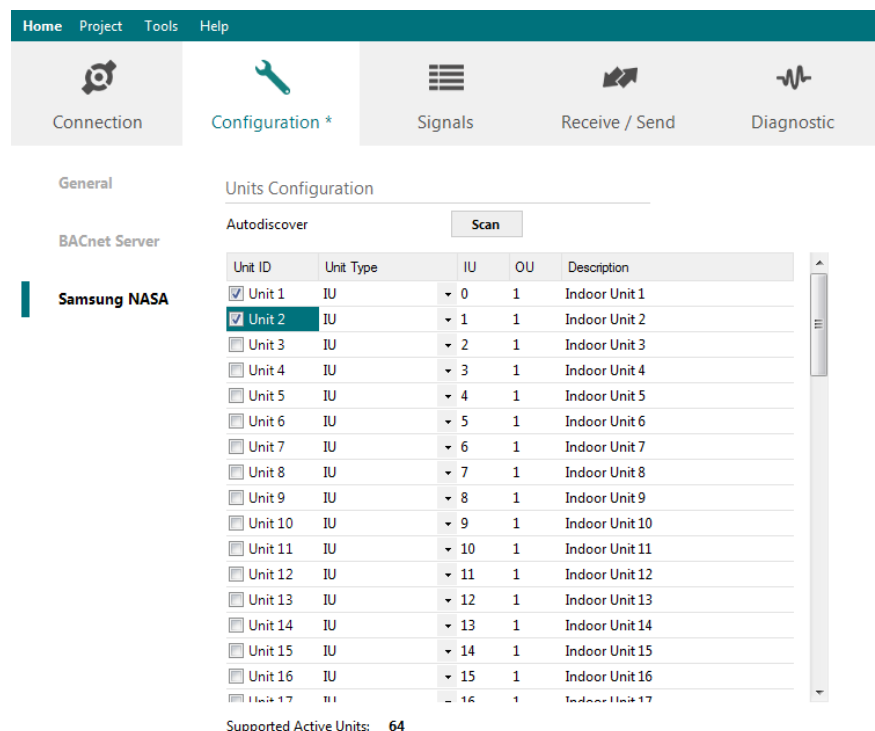

**Figure 4.4** Intesis MAPS Samsung NASA configuration tab

In Units Configuration section you need to enter, for each unit:

- **Active.** If it's active (checkbox at Unit xx), ranging from 1 to 64 indoor units that will be integrated (maximum number of units will depend on Intesis model)
- **Unit type.** Type can be one of the following: IU, HE, HT, EHS, AHU, ERV, ERV+, CHILLER. Available signals will vary according to unit type.
- **IU address.** Address 0..63 of Unit in Samsung NASA R1/R2 bus. Remember that manual addressing of Samsung indoor units is required.
- **OU address.** Address 0..15 of Outdoor Unit in Samsung NASA R1/R2 bus. Remember that manual addressing of Samsung outdoorunits is required.
- **Description.** Descriptive name to ease identification of the unit (for example, 'living room floor 1 unit', etc).

Additional to manual entry of each unit, autodiscover of present units in an R1/R2 installation is possible. To do so, click button **Scan**. Following window will appear:

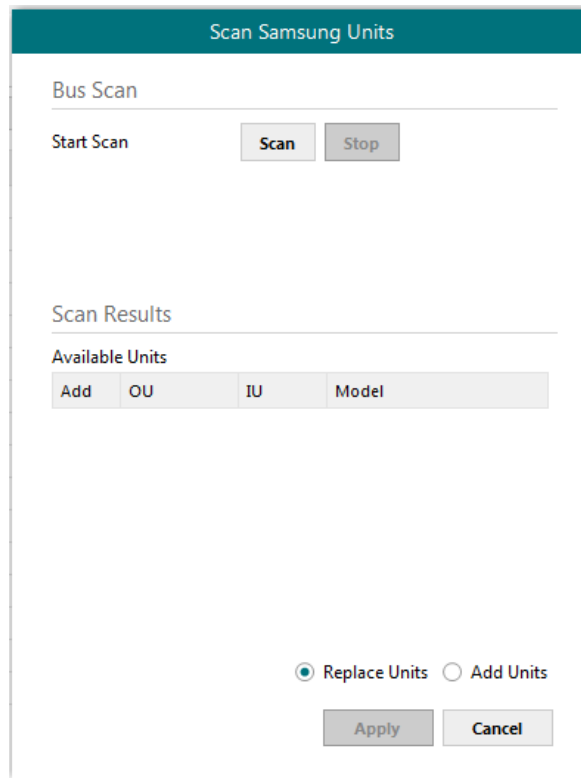

Figure 4.5 Intesis MAPS Scan Samsung Units window

By pressing **Scan** button, connected Samsung NASA R1/R2 bus will be scanned for available units. Error window will appear if there is a problem in the connection with R1/R2 bus (units not powered, bus not connected, ...).

A progress bar will appear during the scan, which will take up to a few minutes. After scan is completed, detected units will be shown in available units as follows:

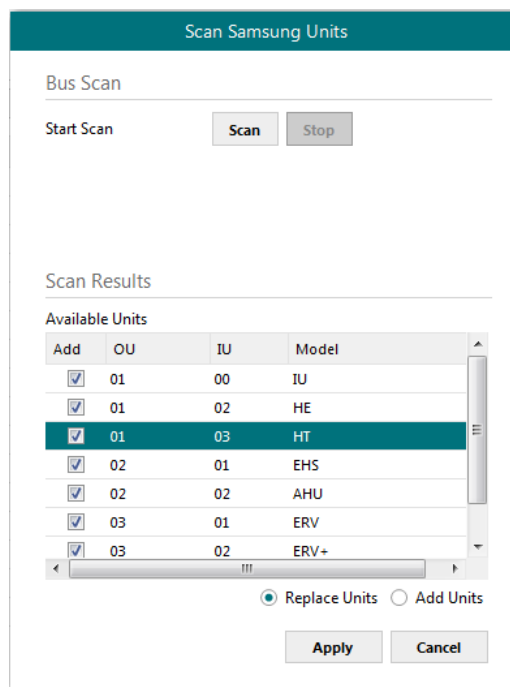

Figure 4.6 Intesis MAPS Scan Samsung Units window with scan results

Select with its checkbox units to add (or replace) in installation, according to selection **Replace Units / Add Units**.



After units to be integrated are selected, click button **Apply**, and changes will appear in previous **Units Configuration** window.

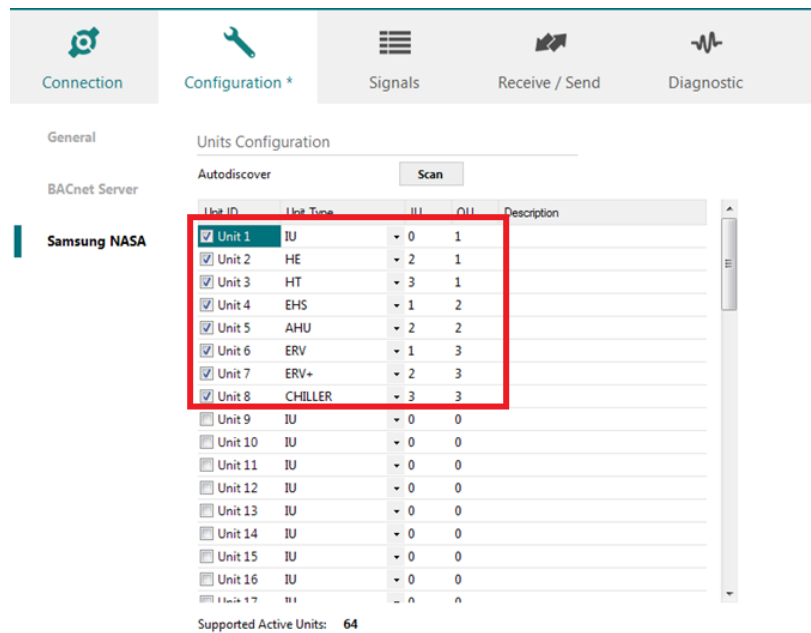

Figure 4.7 Intesis MAPS Samsung NASA configuration tab after importing scan results

### 4.2.6 Signals

All available KNX objects, its corresponding description and other main parameters are listed in the signals tab.

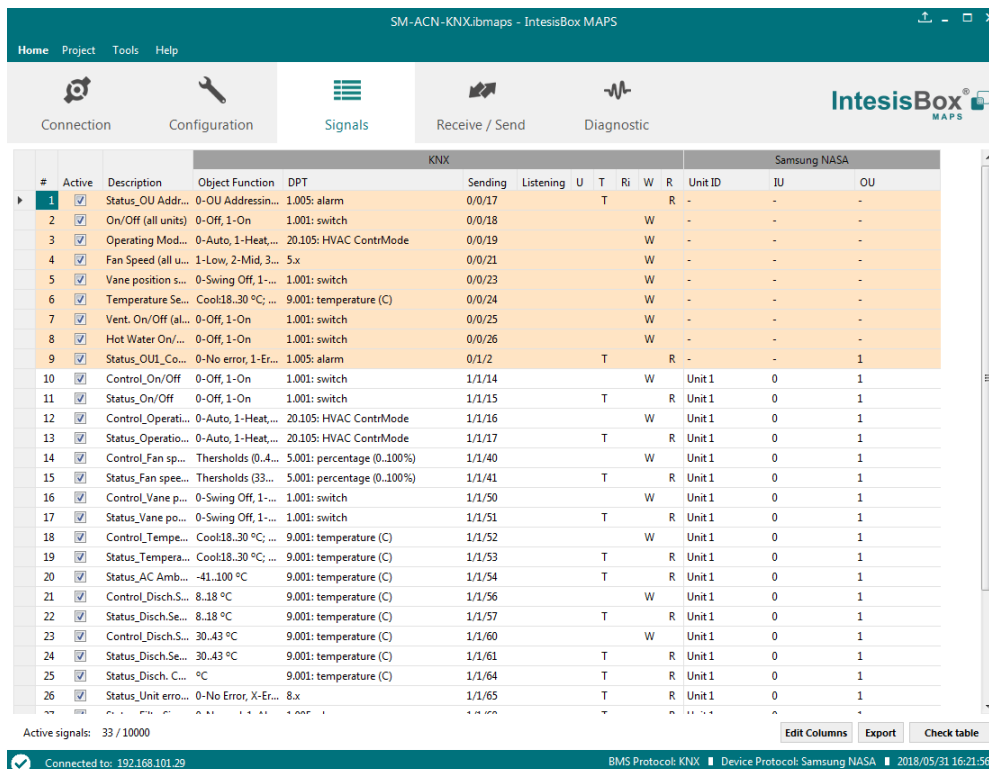

Figure 4.8 Intesis MAPS Signals tab

## 4.2.7 Sending the configuration to Intesis

When the configuration is finished, follow the next steps.

1.- Save the project (Menu option **Project->Save**) on your hard disk (more information in Intesis MAPS User Manual).

2.- Go to tab '**Receive / Send**' of MAPS, and in **Send** section, press **Send** button. Intesis will reboot automatically once the new configuration is loaded.

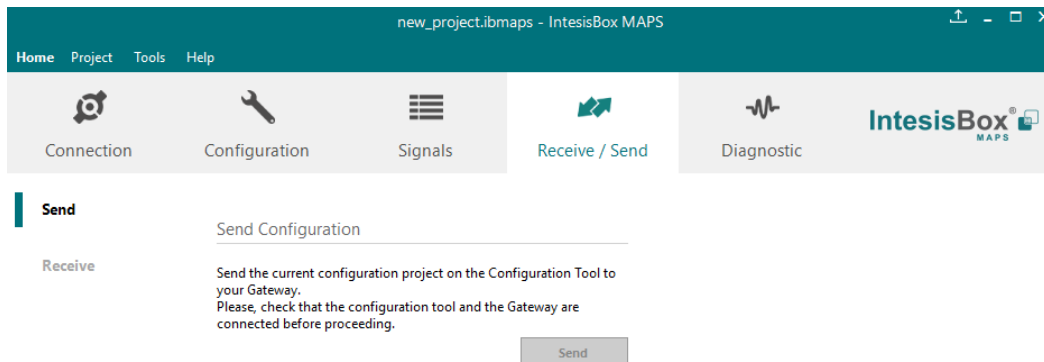

Figure 4.9 Intesis MAPS Receive/Send tab

**After any configuration change, do not forget to send the configuration file to the Intesis using the Send button in the Receive / Send section.**

## 4.2.8 Diagnostic

To help integrators in the commissioning tasks and troubleshooting, the Configuration Tool offers some specific tools and viewers.

In order to start using the diagnostic tools, connection with the Gateway is required.

The Diagnostic section is composed by two main parts: Tools and Viewers.

- **Tools**  
Use the tools section to check the current hardware status of the box, log communications into compressed files to be sent to the support, change the Diagnostic panels' view or send commands to the gateway.
- **Viewers**  
In order to check the current status, viewer for the Internal and External protocols are available. It is also available a generic Console viewer for general information about communications and the gateway status and finally a Signals Viewer to simulate the BMS behavior or to check the current values in the system.

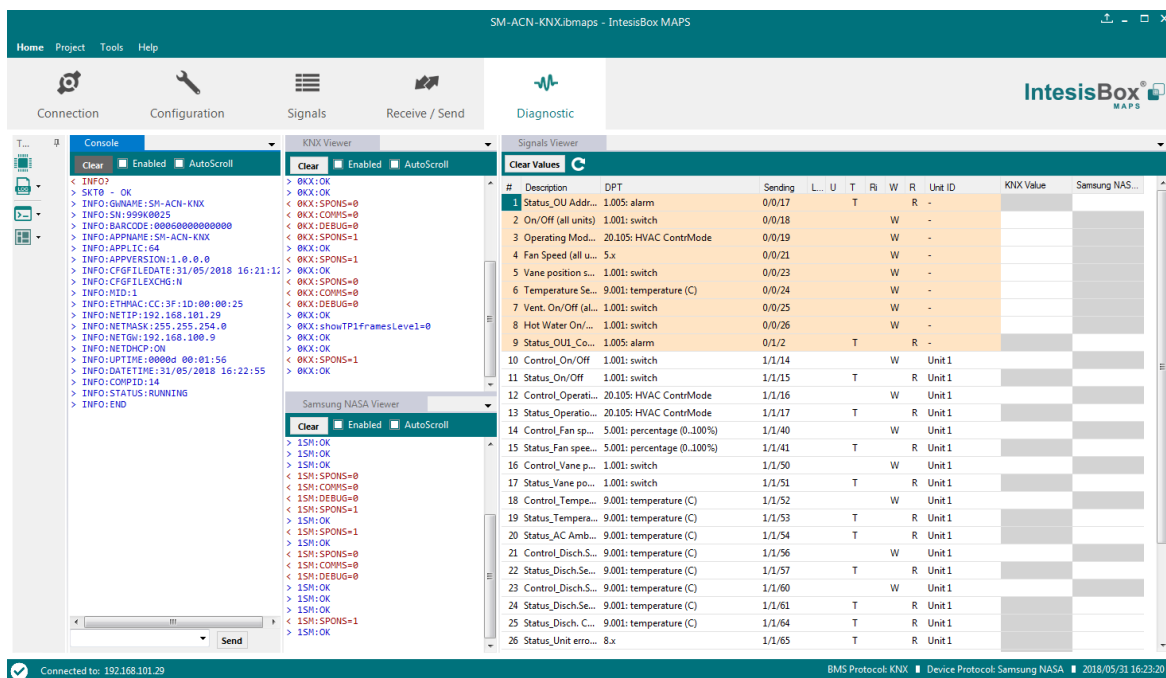

Figure 4.10 Diagnostic

More information about the Diagnostic section can be found in the Configuration Tool manual.

### 4.2.9 Set-up procedure

1. Install Intesis MAPS on your laptop, use the setup program supplied for this and follow the instructions given by the Installation wizard.
2. Install Intesis in the desired installation site. Installation can be on DIN rail or on a stable not vibrating surface (DIN rail mounted inside a metallic industrial cabinet connected to ground is recommended).
3. Connect the KNX communication cable coming from the KNX network to the port marked as Port A on Intesis (More details in section 3).
4. Connect the communication cable coming from the Samsung NASA R1/R2 installation to the port marked as Port B of Intesis (More details in section 3).
5. Power up Intesis. The supply voltage can be 9 to 36 Vdc or just 24 Vac. Take care of the polarity of the supply voltage applied.

**WARNING!** In order to avoid earth loops that can damage Intesis and/or any other equipment connected to it, we strongly recommend:

- The use of DC power supplies, floating or with the negative terminal connected to earth. **Never use a DC power supply with the positive terminal connected to earth.**
  - The use of AC power supplies only if they are floating and not powering any other device.
6. If you want to connect using IP, connect the Ethernet cable from the laptop PC to the port marked as Ethernet of Intesis (More details in section 3).

If you want to connect using USB, connect the USB cable from the laptop PC to the port marked as Console of Intesis (More details in section 3).

7. Open Intesis MAPS, create a new project selecting a copy of the one named **INKNXSAM---O000**.
8. Modify the configuration as desired, save it and download the configuration file to Intesis as explained in the Intesis MAPS user manual.
9. Visit the Diagnostic section and check that there is communication activity, some TX frames and some other RX frames. This means that the communication with the KNX installation and Samsung installation is OK. In case there is no communication activity between Intesis and the KNX side and/or Samsung units, check that those are operative: check communication cable used to connect all devices and any other communication parameter.

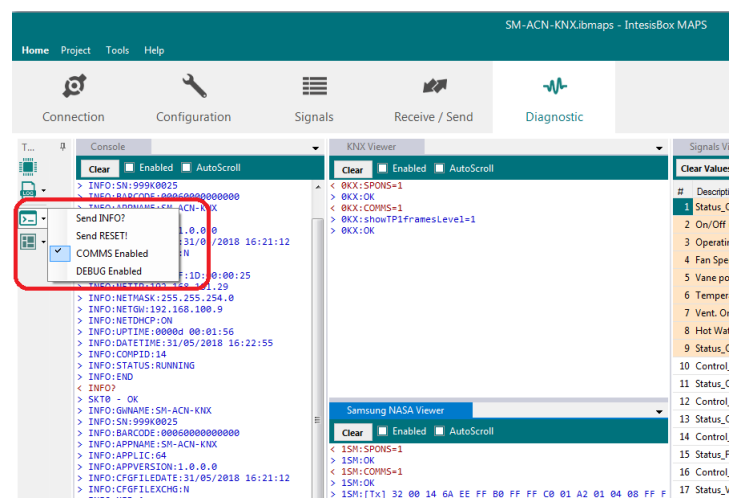

Figure 4.11 Enable COMMS

## 5 Electrical & Mechanical Features



<b>Enclosure</b>	Plastic, type PC (UL 94 V-0) Net dimensions (d×w×h): 90x88x56 mm Recommended space for installation (d×w×h): 130x100x100mm Color: Light Grey. RAL 7035	<b>Battery</b>	Size: Coin 20mm x 3.2mm Capacity: 3V / 225mAh Type: Manganese Dioxide Lithium
<b>Mounting</b>	Wall. DIN rail EN60715 TH35.	<b>Console Port</b>	Mini Type-B USB 2.0 compliant 1500VDC isolation
<b>Terminal Wiring</b> (for power supply and low-voltage signals)	Per terminal: solid wires or stranded wires (twisted or with ferrule) 1 core: 0.5mm <sup>2</sup> ... 2.5mm <sup>2</sup> 2 cores: 0.5mm <sup>2</sup> ... 1.5mm <sup>2</sup> 3 cores: not permitted	<b>USB port</b>	Type-A USB 2.0 compliant Only for USB flash storage device ( <i>USB pen drive</i> ) Power consumption limited to 150mA ( <i>HDD connection not allowed</i> )
<b>Power</b>	1 x Plug-in screw terminal block (3 poles) 9 to 36VDC +/-10%, Max.: 140mA. 24VAC +/-10% 50-60Hz, Max.: 127mA Recommended: 24VDC	<b>Push Button</b>	Button A: Not used Button B: KNX Programming button (not used)
<b>Ethernet</b>	1 x Ethernet 10/100 Mbps RJ45 2 x Ethernet LED: port link and activity	<b>Operation Temperature</b>	0°C to +60°C
<b>Port A</b>	1 x KNX TP-1 Plug-in screw terminal block orange (2 poles) 2500VDC isolation from other ports KNX power consumption: 5mA Voltage rating: 29VDC 1 x Plug-in screw terminal block green (2 poles) Reserved for future use	<b>Operational Humidity</b>	5 to 95%, no condensation
<b>Switch A (SWA)</b>	1 x DIP-Switch for serial EIA485 configuration: Reserved for future use	<b>Protection</b>	IP20 (IEC60529)
<b>PORT B</b>	1 x Serial EIA232 (SUB-D9 male connector) <i>Not used</i> 1 x Samsung Nasa bus Plug-in screw terminal block (3 poles) R1 R2 (Samsung Nasa) 1500VDC isolation from other ports	<b>LED Indicators</b>	10 x On board LED indicators 1 x Error LED 1 x Power LED 2 x Ethernet Link/Speed 2 x Port A TX/RX 2 x Port B TX/RX 1 x Button A indicator 1 x Button B indicator
<b>Switch B (SWB)</b>	1 x DIP-Switch for PORT B configuration: Not used (leave all OFF)		100 mm

## 6 Dimensions

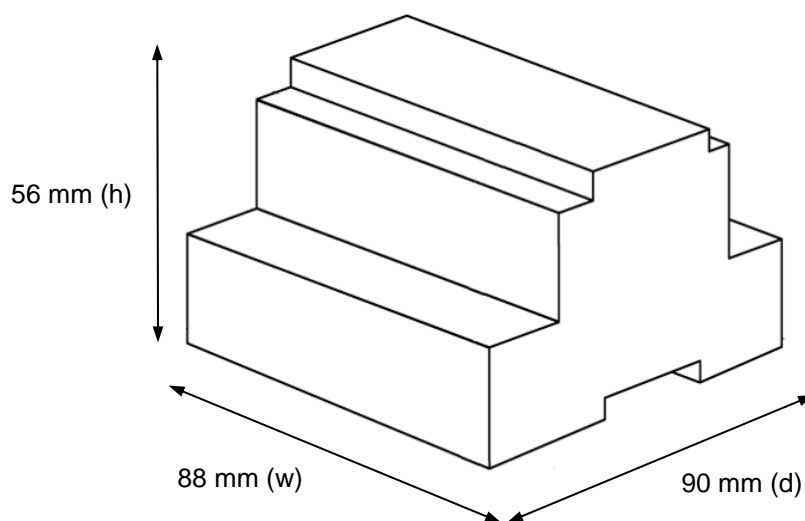

Recommended available space for its installation into a cabinet (wall or DIN rail mounting), with space enough for external connections

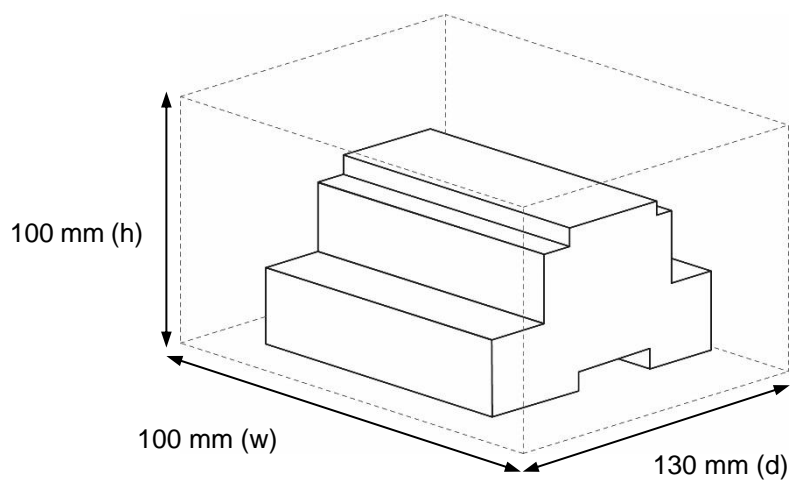

## 7 AC Unit Types compatibility

A list of Samsung unit model references compatible with INKNXSAM004O000 / INKNXSAM008O000 / INKNXSAM016O000 / INKNXSAM064O000 and their available features can be found in:

[https://www.intesis.com/docs/compatibilities/inxxsam0xxo000\\_compatibility](https://www.intesis.com/docs/compatibilities/inxxsam0xxo000_compatibility)

## 8 Error codes for Indoor and Outdoor Units

This list contains all possible values shown in KNX Object for “Error Code” for each indoor unit and outdoor unit.

It must be taken into account that Outdoor Units are only able to reflect a single error for each indoor / outdoor unit in the system. Thus, a unit having two or more active errors from that list will only report a single error code – the one of the first error that has been detected.

Error Code	Description
101	Indoor unit communication error. Indoor unit can not receive any data from outdoor unit.
102	Communication error between indoor unit and outdoor unit. Displayed in indoor unit.
108	Error due to repeated address setting (When 2 or more devices has same address within the
110	Communication error between Hydro unit HT(Main PBA) and Control kit PBA(Detection from the Control kit)
121	Error on indoor temperature sensor of indoor unit (Short or Open)
122	Error on EVA IN sensor of indoor unit (Short or Open)
123	Error on EVA OUT sensor of indoor unit (Short or Open)
128	EVA IN temperature sensor of indoor unit is detached from EVA IN pipe
129	EVA OUT temperature sensor of indoor unit is detached from EVA OUT pipe
130	Heat exchanger in/out sensors of indoor unit are detached
135	RPM feedback error of indoor unit's cleaning fan
151	Error due to opened EEV of indoor unit (2nd detection)
152	Error due to closed EEV of indoor unit (2nd detection)
153	Error on floating switch of indoor unit (2nd detection)
154	RPM feedback error of indoor unit
161	Mixed operation mode error of indoor unit; When outdoor unit is getting ready to operate in cooling (or heating) and some of the indoor unit is trying to operate in heating (or cooling) mode
162	EEPROM error of MICOM (Physical problem of parts/circuit)
163	Indoor unit's remote controller option input is Incorrect or missing. Outdoor unit EEPROM data error
180	Simultaneous opening of cooling/heating MCU SOL V/V (1st detection)
181	Simultaneous opening of cooling/heating MCU SOL V/V (2nd detection)
185	Cross wiring error between communication and power cable of indoor unit
186	Connection error or problem on SPi
190	No temperature changes in EVA IN during pipe inspection or changes in temperature indoor unit with wrong address
191	No temperature changes in EVA OUT during pipe inspection or changes in temperature is seen in indoor unit with wrong address
198	Error due to disconnected thermal fuse of indoor unit
201	Communication error between indoor and outdoor units (installation number setting error, repeated indoor unit address, indoor unit communication cable error)
202	Communication error between indoor and outdoor units (Communication error on all indoor unit, outdoor unit communication cable error)
203	Communication error between main and sub outdoor units
205	Communication error on all PBA within the outdoor unit C-Box, communication cable error
206	E206-C001: HUB PBA communication error / E206-C002: FAN PBA communication error E206-C003: INV1 PBA communication error / E206-C004: INV2 PBA communication error
211	When single indoor unit uses 2 MCU ports that are not in series.
212	If the rotary switch (on the MCU) for address setting of the indoor unit has 3 or more of the same address



213	When total number of indoor units assigned to MCU is same as actual number of installed indoor units but there is indoor unit that is not installed even though it is assigned on MCU
214	When number of MCU is not set correctly on the outdoor unit or when two or more MCU was installed some of them have the same address
215	When two different MCU's have same address value on the rotary switch
216	When indoor unit is not installed to a MCU port but the switch on the port is set to On.
217	When indoor unit is connected to a MCU port but indoor unit is assigned to a MCU and the switch on the port is set to Off
218	When there's at least one or more actual number of indoor unit connection compared to number of indoor units assigned to MCU
219	Error on temperature sensor located on MCU intercooler inlet (Short or Open)
220	Error on temperature sensor located on MCU intercooler outlet (Short or Open)
221	Error on outdoor temperature sensor of outdoor unit (Short or open)
231	Error on COND OUT temperature sensor of main outdoor unit (Short or Open)
241	COND OUT sensor is detached
251	Error on discharge temperature sensor of compressor 1 (Short or Open)
257	Error on discharge temperature sensor of compressor 2 (Short or Open)
262	Discharge temperature sensor of compressor 1 is detached from the sensor holder on the pipe
263	Discharge temperature sensor of compressor 2 is detached from the sensor holder on the pipe
266	Top sensor of compressor 1 is detached
267	Top sensor of compressor 2 is detached
269	Suction temperature sensor is detached from the sensor holder on the pipe
276	Error on top sensor of compressor 1 (Short or Open)
277	Error on top sensor of compressor 2 (Short or Open)
291	Refrigerant leakage or error on high pressure sensor (Short or Open)
296	Refrigerant leakage or error on low pressure sensor (Short or Open)
308	Error on suction temperature sensor (Short or Open)
311	Error on temperature sensor of double layer pipe/liquid pipe(sub heat exchanger) (Short or Open)
321	Error on EVI (ESC) IN temperature sensor (Short or Open)
322	Error on EVI (ESC) OUT temperature sensor (Short or Open)
323	Error on suction sensor 2 (Short or Open)
346	Error due to operation failure of Fan2
347	Motor wire of Fan2 is not connected
348	Lock error on Fan2 of outdoor unit
353	Error due to overheated motor of outdoor unit's Fan2
355	Error due to overheated IPM of Fan2
361	Error due to operation failure of inverter compressor 2
364	Error due to over-current of inverter compressor 2
365	V-limit error of inverter compressor 2
366	Error due to over voltage /low voltage of inverter PBA2
367	Error due to unconnected wire of compressor 2
368	Output current sensor error of inverter PBA2
369	DC voltage sensor error of inverter PBA2
374	Heat sink temperature sensor error of inverter PBA2
378	Error due to overcurrent of Fan2
385	Error due to input current of inverter 2
386	Over-voltage/low-voltage error of Fan2
387	Hall IC connection error of Fan2
389	V-limit error on Fan2 of compressor

393	Output current sensor error of Fan2
396	DC voltage sensor error of Fan2
399	Heat sink temperature sensor error of Fan2
400	Error due to overheat caused by contact failure on IPM of Inverter PBA2
407	Compressor operation stop due to high pressure protection control
410	Compressor operation stop due to low pressure protection control or refrigerant leakage
416	Compressor operation stop due to discharge temperature protection control
425	Phase reversal or phase failure (3Ø outdoor unit wiring, R-S-T-N ), connection error on 3 phase input
428	Compressor operation stop due abnormal compression ratio
438	EVI (ESC) EEV leakage or internal leakage of intercooler or incorrect connector insertion of EVI (ESC) EEV
439	Error due to refrigerant leakage
440	Heating mode restriction due to high air temperature
441	Cooling mode restriction due to low air temperature
442	Refrigerant charging restriction in heating mode when air temperature is over 15 °C
443	Operation prohibited due to the pressure drop
445	CCH is deatched
446	Error due to operation failure of Fan1
447	Motor wire of Fan1 is not connected
448	Lock error on Fan1
452	Error due to ZPC detection circuit problem or power failure
453	Error due to overheated motor of outdoor unit's Fan1
455	Error due to overheated IPM of Fan1
461	Error due to operation failure of inverter compressor 1
462	Compressor stop due to full current control or error due to low current on CT2
464	Error due to over-current of inverter compressor 1
465	V-limit error of inverter compressor 1
466	Error due to over voltage /low voltage of inveter PBA1
467	Error due to unconnected wire of compressor 1
468	Output current sensor error of inverter PBA1
469	DC voltage sensor error of inver PBA1
474	Heat sink temperature sensor error of inverter PBA1
478	Error due to overcurrent of Fan1
485	Error due to input current of inverter 1
486	Error due to over voltage/low voltage of Fan
487	Hall IC error of Fan1
489	V-limit error on Fan1 of compressor
493	Output current sensor error of Fan1
496	DC voltage sensor error of Fan1
499	Heat sink temperature sensor error of Fan1
500	Error due to overheat caused by contact failure on IPM of Inverter PBA1
503	Error due to alert the user to check if the service valve is closed
504	Error due to self diagnosis of compressor operation
505	Error due to self diagnosis of high pressure sensor
506	Error due to self diagnosis of low pressure sensor
560	Outdoor unit's option switch setting error (when inappropriate option switch is on)
563	Error due to module installation of indoor unit with old version (Micom version needs to be checked)
573	Error due to using single type outdoor unit in a module installation

601	Communication error between remote controller and the DVM Hydro unit / Hydro unit HT
602	Communication error between master and slave remote controller
604	Tracking error between remote controller and the DVM Hydro unit / Hydro unit HT
618	Error due to exceeding maximum numbers of Hydro unit installation (16 units)
627	Error due to exceeding maximum numbers of wired remote controller installation (2 units)
633	Error caused by installing mixed models
653	Remote controller's temperature sensor is disconnected or has problem
654	Data error on remote controller (Memory read/write error)
702	Error due to closed EEV of indoor unit (1st detection)
703	Error due to opened EEV of indoor unit (1st detection)
901	Error on the sensor of water inlet pipe (Short or Open)
902	Error on the sensor of water outlet pipe (Short or Open)
904	Error on water tank (Short or open)
907	Error due to pipe rupture protection
908	Error due to freeze prevention(Re-operation is possible)
909	Error due to freeze prevention(Re-operation is impossible)
910	Water temperature sensor on water outlet pipe is detached
911	Flow switch off error, When the switch is turned off within 10 seconds after a pump starts its operation(Re-operation is possible)
913	Six times detection for Flow Switch Error(Re-operation is not possible)
914	Error due to incorrect thermostat connection
915	Error on DC fan(Non-operating)
573	Error due to using single type outdoor unit in a module installation
601	Communication error between remote controller and the DVM Hydro unit / Hydro unit HT
602	Communication error between master and slave remote controller
604	Tracking error between remote controller and the DVM Hydro unit / Hydro unit HT
618	Error due to exceeding maximum numbers of Hydro unit installation (16 units)
627	Error due to exceeding maximum numbers of wired remote controller installation (2 units)
633	Error caused by installing mixed models
653	Remote controller's temperature sensor is disconnected or has problem
654	Data error on remote controller (Memory read/write error)
702	Error due to closed EEV of indoor unit (1st detection)
703	Error due to opened EEV of indoor unit (1st detection)
901	Error on the sensor of water inlet pipe (Short or Open)
902	Error on the sensor of water outlet pipe (Short or Open)
904	Error on water tank (Short or open)
907	Error due to pipe rupture protection
908	Error due to freeze prevention(Re-operation is possible)
909	Error due to freeze prevention(Re-operation is impossible)
910	Water temperature sensor on water outlet pipe is detached
911	Flow switch off error, When the switch is turned off within 10 seconds after a pump starts its operation(Re-operation is possible)
913	Six times detection for Flow Switch Error(Re-operation is not possible)
914	Error due to incorrect thermostat connection
915	Error on DC fan(Non-operating)

## 9 Appendix A – Communication Objects Table

Available signals depend on unit type, which must be selected in MAPS configuration tool (IU, HE, HT, EHS, AHU, ERV, ERV+, CHILLER)

TOPIC		UNIT TYPE								NAME	LEN	DATAPOINT TYPE		FLAGS				FUNCTION
		IU	HE	HT	EHS	AHU	ERV	ERV+	CHILLER			DPT_NAME	DPT_ID	R	W	T	U	
GLOBAL SIGNALS	COMM ERR	x	x	x	x	x	x	x	x	Status_OUXX_Communication Error OU	1 bit	DPT_Alarm	1.005	R		T		0-No error, 1-Error
		x	x	x	x	x	x	x	x	Status_OU Addressing Error	1 bit	DPT_Alarm	1.005	R		T		0-OU Addressing OK; 1-Manual Addr in OU required
	ON/OFF	x	x	x	x	x	x	x	On/Off (all units)	1 bit	DPT_Switch	1.001		W			0-Off, 1-On	
	OP MODE	x	x	x	x	x	x	x	x	Operating Mode (all units)	1 byte	DPT_HVACContrMode	20.105		W			0-Auto, 1-Heat, 3-Cool, 9-Fan, 14-Dry
		x	x	x	x	x	x	x	x	Operating Mode (all units)	1 byte	Non-standarized	5.x		W			0-Auto, 1-Heat, 2-Dry, 3-Fan, 4-Cool, 5-Cool Storage, 6-Heat Storage
	FAN SPEED	x	x	x	x	x	x	x	x	Fan Speed (all units)	1 byte	Non-standarized	5.x		W			1-Low, 2-Mid, 3-High
		x	x	x	x	x	x	x	x	Fan Speed AUTO (all units)	1 bit	DPT_Switch	1.001		W			1-Set auto fan; 0-Stop auto fan
	FAN SPEED	x	x	x	x	x	x	x	x	Vane position swing (all units)	1 bit	DPT_Switch	1.001		W			0-Swing Off, 1-Swing On
	SETP TEMP	x	x	x	x	x	x	x	x	Temperature Setpoint (°C) (all units)	2 byte	DPT_Value_Temp	9.001		W			Cool:18..30 °C; Heat:16..30 °C
	VENT	x	x	x	x	x	x	x	x	Vent. On/Off (all units)	1 bit	DPT_Switch	1.001		W			0-Off, 1-On
HOT WATER	x	x	x	x	x	x	x	x	Hot Water On/Off (all units)	1 bit	DPT_Switch	1.001		W			0-Off, 1-On	
	ON / OFF	x	x	x	x	x		x	x	Control_OXXUXX_On/Off	1 bit	DPT_Switch	1.001		W			0-Off,1-On
		x	x	x	x	x		x	x	Status_OXXUXX_On/Off	1 bit	DPT_Switch	1.001	R		T	0-Off,1-On	
	OP MODE	x	x		x	x		x	x	Control_OXXUXX_Operation mode	1 byte	DPT_HVACContrMode	20.105		W			0-Auto, 1-Heat, 3-Cool, 9-Fan, 14-Dry
		x	x		x	x		x	x	Status_OXXUXX_Operation mode	1 byte	DPT_HVACContrMode	20.105	R		T	0-Auto, 1-Heat, 3-Cool, 9-Fan, 14-Dry	

UNIT SIGNALS	x	x		x	x		x	x	Control_OXXUXX_Operation mode	1 byte	Non-standarized	5.x		W		0-Auto, 1-Heat, 2-Dry, 3-Fan, 4-Cool, 5-Cool Storage, 6-Heat Storage
	x	x		x	x		x	x	Status_OXXUXX_Operation mode	1 byte	Non-standarized	5.x	R		T	0-Auto, 1-Heat, 2-Dry, 3-Fan, 4-Cool, 5-Cool Storage, 6-Heat Storage
	x	x		x	x		x	x	Control_OXXUXX_Mode Cool/Heat	1 bit	DPT_Heat/Cool	1.100		W		0-Cool, 1-Heat
	x	x		x	x		x	x	Status_OXXUXX_Mode Cool/Heat	1 bit	DPT_Heat/Cool	1.100	R		T	0-Cool, 1-Heat
	x	x		x	x		x	x	Control_OXXUXX_Heat mode&ON	1 byte	DPT_Scaling	5.001		W		0%-Off, 1%-100%-On+Heat
	x	x		x	x		x	x	Control_OXXUXX_Cool mode&ON	1 byte	DPT_Scaling	5.001		W		0%-Off, 1%-100%-On+Cool
	x			x	x		x		Control_OXXUXX_Auto mode	1 bit	DPT_Switch	1.001		W		1-Set auto mode
	x			x	x		x		Status_OXXUXX_Auto mode	1 bit	DPT_Switch	1.001	R		T	1-Auto mode active, 0-Auto mode not active
	x	x		x	x		x	x	Control_OXXUXX_Heat mode	1 bit	DPT_Switch	1.001		W		1-Set heat mode
	x	x		x	x		x	x	Status_OXXUXX_Heat mode	1 bit	DPT_Switch	1.001	R		T	1-Heat mode active, 0-Heat mode not active
	x	x		x	x		x	x	Control_OXXUXX_Cool mode	1 bit	DPT_Switch	1.001		W		1-Set cool mode
	x	x		x	x		x	x	Status_OXXUXX_Cool mode	1 bit	DPT_Switch	1.001	R		T	1-Cool mode active, 0-Cool mode not active
	x			x					Control_OXXUXX_Fan mode	1 bit	DPT_Switch	1.001		W		1-Set fan mode
	x			x					Status_OXXUXX_Fan mode	1 bit	DPT_Switch	1.001	R		T	1-Fan mode active, 0-Fan mode not active
	x			x					Control_OXXUXX_Dry mode	1 bit	DPT_Switch	1.001		W		1-Set dry mode
	x			x					Status_OXXUXX_Dry mode	1 bit	DPT_Switch	1.001	R		T	1-Dry mode active, 0-Dry mode not active
								x	Control_OXXUXX_Cool storage mode	1 bit	DPT_Switch	1.001		W		1-Set cool storage mode
								x	Status_OXXUXX_Cool storage mode	1 bit	DPT_Switch	1.001	R		T	1-Cool storage mode active, 0-Cool storage mode not active
								x	Control_OXXUXX_Heat storage mode	1 bit	DPT_Switch	1.001		W		1-Set heat storage mode
								x	Status_OXXUXX_Heat storage mode	1 bit	DPT_Switch	1.001	R		T	1-Heat storage mode active, 0-Heat storage mode not active
FAN SPEED	x							Control_OXXUXX_Fan speed enumerated	1 byte	Non-standarized	5.x		W		1-Low, 2-Mid, 3-High	
	x							Status_OXXUXX_Fan speed enumerated	1 byte	Non-standarized	5.x	R		T	1-Low, 2-Mid, 3-High	
	x							Control_OXXUXX_Fan speed scaling	1 byte	DPT_Scaling	5.001		W		Thersholds (0..49%, 50..82%, 83..100%)	

UNIT SIGNALS	VANE POS	x							Status_OXXUXX_Fan speed scaling	1 byte	DPT_Scaling	5.001	R		T		Thresholds (33%, 67%, 100%)
		x							Control_OXXUXX_Fan speed low	1 bit	DPT_Switch	1.001		W			1-Set fan speed low
		x							Status_OXXUXX_Fan speed low	1 bit	DPT_Switch	1.001	R		T		1-Speed low active, 0-Speed low not active
		x							Control_OXXUXX_Fan speed mid	1 bit	DPT_Switch	1.001		W			1-Set fan speed mid
		x							Status_OXXUXX_Fan speed mid	1 bit	DPT_Switch	1.001	R		T		1-Speed mid active, 0-Speed mid not active
		x							Control_OXXUXX_Fan speed high	1 bit	DPT_Switch	1.001		W			1-Set fan speed high
		x							Status_OXXUXX_Fan speed high	1 bit	DPT_Switch	1.001	R		T		1-Speed high active, 0-Speed high not active
		x							Control_Fan speed Man/Auto	1 bit	DPT_Switch	1.001		W			0-Manual; 1-Auto
		x							Status_Fan speed Man/Auto	1 bit	DPT_Switch	1.001	R		T		0-Manual; 1-Auto
	x							Control_OXXUXX_Vane position swing	1 bit	DPT_Switch	1.001		W			0-Swing Off, 1-Swing On	
	x							Status_OXXUXX_Vane position swing	1 bit	DPT_Switch	1.001	R		T		0-Swing Off, 1-Swing On	
	x			x	x			Control_OXXUXX_Temperature Setpoint (°C)	2 byte	DPT_Value_Temp	9.001		W			Cool:18..30 °C; Heat:16..30 °C	
	x			x	x			Status_OXXUXX_Temperature Setpoint (°C)	2 byte	DPT_Value_Temp	9.001	R		T		Cool:18..30 °C; Heat:16..30 °C	
	x			x	x			Status_OXXUXX_AC Ambient Temperature (°C)	2 byte	DPT_Value_Temp	9.001	R		T		-41..100 °C	
	x			x	x			Control_OXXUXX_KNX ambient Temperature (°C)	2 byte	DPT_Value_Temp	9.001		W			°C	
	x							Control_OXXUXX_Disch.Setpoint Cool IU	2 byte	DPT_Value_Temp	9.001		W			8..18 °C	
	x							Status_OXXUXX_Disch.Setpoint Cool IU	2 byte	DPT_Value_Temp	9.001	R		T		8..18 °C	
						x		Control_OXXUXX_Disch.Setpoint Cool AHU	2 byte	DPT_Value_Temp	9.001		W			8..25 °C	
						x		Status_OXXUXX_Disch.Setpoint Cool AHU	2 byte	DPT_Value_Temp	9.001	R		T		8..25 °C	
	x							Control_OXXUXX_Disch.Setpoint Heat IU	2 byte	DPT_Value_Temp	9.001		W			30..43 °C	
x							Status_OXXUXX_Disch.Setpoint Heat IU	2 byte	DPT_Value_Temp	9.001	R		T		30..43 °C		
					x		Control_OXXUXX_Disch.Setpoint Heat AHU	2 byte	DPT_Value_Temp	9.001		W			18..43 °C		
					x		Status_OXXUXX_Disch.Setpoint Heat AHU	2 byte	DPT_Value_Temp	9.001	R		T		18..43 °C		

UNIT SIGNALS		x				x				Status_OXXUXX_Disch. Current Temp.	2 byte	DPT_Value_Temp	9.001	R		T		°C	
	ERROR CODE	x	x	x	x	x	x	x	x		Status_OXXUXX_Unit error code	2 byte	Non-standarized	8.x	R		T		0-No Error, X-Error (100..999)
										x	Status_OXXUXX_Error slave chiller unit	2 byte	Non-standarized	8.x	R		T		0-No error, X-Error (100 to 999)
										x	Status_OXXUXX_Slave chiller in error	2 byte	Non-standarized	8.x	R		T		bX: 1-Error in Unit X (b15...b0)
	FILTER	x				x	x	x			Status_OXXUXX_FilterSign	1 bit	DPT_Alarm	1.005	R		T		0-Normal, 1-Alarm
		x					x	x			Control_OXXUXX_FilterReset	1 bit	DPT_Reset	1.015		W			0-No reset, 1-Reset
	COMM STATUS	x	x	x	x	x	x	x	x		Status_OXXUXX_Communication status	1 byte	Non-standarized	5.x	R				b0-Exist, b1-Ready, b2-Data updated, b3-Type OK
	REMOC.	x	x	x	x	x	x	x	x		Control_OXXUXX_Remote controll disablement	1 bit	DPT_Bool	1.002		W			0-No disabled, 1-Disabled
		x	x	x	x	x	x	x	x		Status_OXXUXX_Remote controll disablement	1 bit	DPT_Bool	1.002	R		T		0-No disabled, 1-Disabled
	BUZZER	x									Control_OXXUXX_Buzzer Sound	1 bit	DPT_Switch	1.001		W			0-Buzzer On, 1-Buzzer Off
	UNIT TYP	x	x	x	x	x	x	x	x		Status_OXXUXX_Unit type	1 byte	Non-standarized	5.x	R		T		1-IU, 2-HE, 3-HT, 4-AHU, 5-ERV, 6-ERV+, 7-EHS, 8-CHILLER, 13:Not Defined
	HOT WATER ON/OFF		x	x	x						Control_OXXUXX_HotWater On/Off	1 bit	DPT_Switch	1.001		W			0-Off, 1-On
			x	x	x						Status_OXXUXX_HotWater On/Off	1 bit	DPT_Switch	1.001	R		T		0-Off, 1-On
	HOT WATER MODE		x	x							Control_OXXUXX_HotWater Mode HE/HT	1 byte	Non-standarized	5.x		W			1-Eco; 2-Standby; 3-Power
			x	x							Status_OXXUXX_HotWater Mode HE/HT	1 byte	Non-standarized	5.x	R		T		1-Eco; 2-Standby; 3-Power
					x						Control_OXXUXX_HotWater Mode EHS	1 byte	Non-standarized	5.x		W			1-Eco; 2-Standby; 3-Power; 4-Force
					x						Status_OXXUXX_HotWater Mode EHS	1 byte	Non-standarized	5.x	R		T		1-Eco; 2-Standby; 3-Power; 4-Force
			x	x	x						Control_OXXUXX_HotWater Eco Mode	1 bit	DPT_Switch	1.001		W			1-Set eco mode
			x	x	x						Status_OXXUXX_HotWater Eco Mode	1 bit	DPT_Switch	1.001	R		T		1-Eco mode active, 0-Eco mode not active
			x	x	x						Control_OXXUXX_HotWater Standby Mode	1 bit	DPT_Switch	1.001		W			1-Set standby mode
			x	x	x						Status_OXXUXX_HotWater Standby Mode	1 bit	DPT_Switch	1.001	R		T		1-Standby mode active, 0-Standby mode not active
			x	x	x						Control_OXXUXX_HotWater Power Mode	1 bit	DPT_Switch	1.001		W			1-Set power mode
			x	x	x						Status_OXXUXX_HotWater Power Mode	1 bit	DPT_Switch	1.001	R		T		1-Power mode active, 0-Power mode not active
				x						Control_OXXUXX_HotWater Force Mode	1 bit	DPT_Switch	1.001		W			1-Set force mode	
			x						Status_OXXUXX_HotWater Force Mode	1 bit	DPT_Switch	1.001	R		T		1-Force mode active, 0-Force mode not active		
	x								Control_OXXUXX_HotWater Setpoint HE	2 byte	DPT_Value_Temp	9.001		W			30..75 °C		
	x								Status_OXXUXX_HotWater Setpoint HE	2 byte	DPT_Value_Temp	9.001	R		T		30..75 °C		

