

Modbus RTU (EIA-485) Interface for Daikin air conditioners

Compatible with VRV and SKY line air conditioners commercialized by Daikin

USER MANUAL

Issue date: 10/2020 r3.8 ENGLISH



Important User Information

Disclaimer

The information in this document is for informational purposes only. Please inform HMS Industrial Networks of any inaccuracies or omissions found in this document. HMS Industrial Networks disclaims any responsibility or liability for any errors that may appear in this document.

HMS Industrial Networks reserves the right to modify its products in line with its policy of continuous product development. The information in this document shall therefore not be construed as a commitment on the part of HMS Industrial Networks and is subject to change without notice. HMS Industrial Networks makes no commitment to update or keep current the information in this document.

The data, examples and illustrations found in this document are included for illustrative purposes and are only intended to help improve understanding of the functionality and handling of the product. In view of the wide range of possible applications of the product, and because of the many variables and requirements associated with any particular implementation, HMS Industrial Networks cannot assume responsibility or liability for actual use based on the data, examples or illustrations included in this document nor for any damages incurred during installation of the product. Those responsible for the use of the product must acquire sufficient knowledge in order to ensure that the product is used correctly in their specific application and that the application meets all performance and safety requirements including any applicable laws, regulations, codes and standards. Further, HMS Industrial Networks will under no circumstances assume liability or responsibility for any problems that may arise as a result from the use of undocumented features or functional side effects found outside the documented scope of the product. The effects caused by any direct or indirect use of such aspects of the product are undefined and may include e.g. compatibility issues and stability issues.

Modbus RTU (EIA-485) Interface for Daikin air conditioners
Compatible with VRV and SKY line air conditioners
commercialized by Daikin

ORDER CODE	LEGACY ORDER CODE
INMBSDAI001R000	DK-RC-MBS-1

INDEX

1.	Presentation	5
2.	Connection	6
2.1	Connect to the AC indoor unit	6
2.2	Connection to the EIA-485 bus	7
3.	Quick Start Guide.....	7
4.	Modbus Interface Specification	8
4.1	Modbus physical layer.....	8
4.2	Modbus Registers.....	8
4.2.1	Control and status registers	8
4.2.2	Configuration Registers.....	10
4.2.3	Considerations on Temperature Registers	11
4.3	DIP-switch Configuration Interface	14
4.4	Implemented Functions	17
4.5	Device LED indicator	17
4.6	EIA-485 bus. Termination resistors and Fail-Safe Biasing mechanism	18
5.	Electrical and Mechanical features	19
6.	List of supported AC Unit Types.	20
7.	Error Codes	21
8.	Annex 1: Master/Slave of Operation Mode.....	25

1. Presentation



The INMBSDAI001R000 interfaces allow a complete and natural integration of **Daikin** air conditioners into Modbus RTU (EIA-485) networks.

Compatible with all SKY Air and VRV models commercialized by **Daikin**. Check the Section 6 to obtain more information.

Reduced dimensions. 93 x 53 x 58 mm
3.7" x 2.1" x 2.3"

- Quick and easy installation.
Mountable on DIN rail, wall, or even inside the indoor unit on some models of AC.
- External power not required.
- Direct connection to Modbus RTU (EIA-485) networks. Up to 63 INMBSDAI001R000 devices can be connected in the same network.
INMBSDAI001R000 is a Modbus slave device.
- Direct connection to the AC indoor unit. Up to 16 AC indoor units can be connected to INMBSDAI001R000, controlling them as one (not individually).
- Configuration from both on-board DIP-switches and Modbus RTU.
- Total Control and Supervision.
- Real states of the AC unit's internal variables.
- Allows simultaneous use of the AC's remote controls and Modbus RTU.

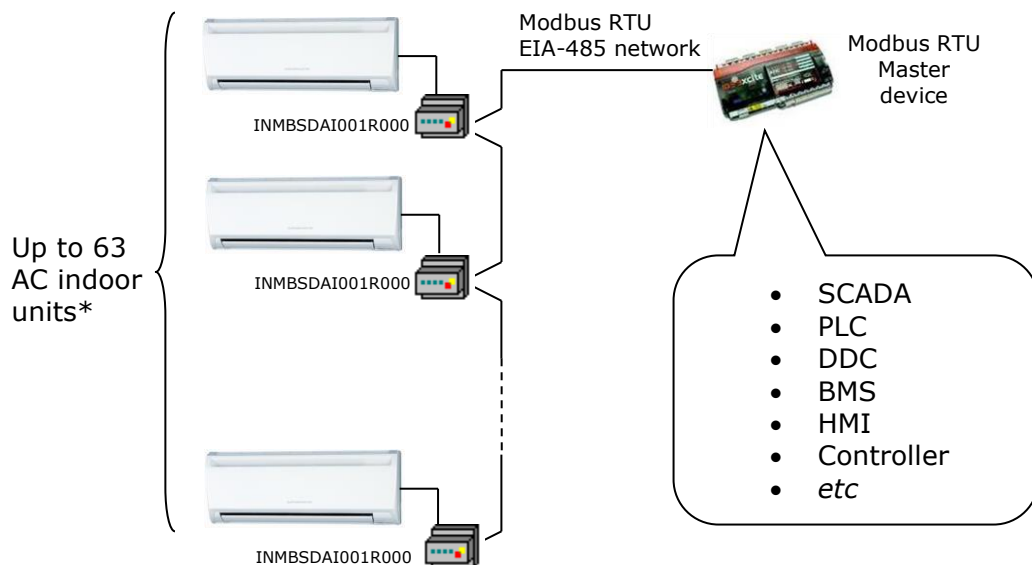

* Up to 63 Intesis devices can be installed in the same Modbus RTU bus. However, depending on the configured speed, the installation of Modbus Repeaters may be required

2. Connection

The interface comes with a plug-in terminal block of 2 poles to establish direct connection with the AC indoor unit. It comes as well with a plug-in terminal block of 2 poles to establish direct connection with the Modbus RTU EIA-485 network.

2.1 Connect to the AC indoor unit

The INMBSDAI001R000 connects directly to the Daikin P1P2 Bus, which is not provided within the interface. Depending on which controllers are available, the recommended connection methods are the following ones (details in **Figure 2. 1**):

- **Wired remote control available.** Connect the gateway as Slave in parallel with the wired remote controllers (Controller acts as Master).
- **Infrared remote control available.** Connect the gateway as Master in parallel with the infrared remote controller (Infrared Remote Control as Slave).
- **No remote control available** Connect the gateway directly to the P1P2 bus of the indoor unit as Master when there is no Daikin Remote Controller.

Maximum P1 P2 bus length is 500 meters / 1,640.42 ft . The bus has no polarity sensitivity.

Important: If a wired remote controller of the AC manufacturer is connected in the same bus, communication may shut down.

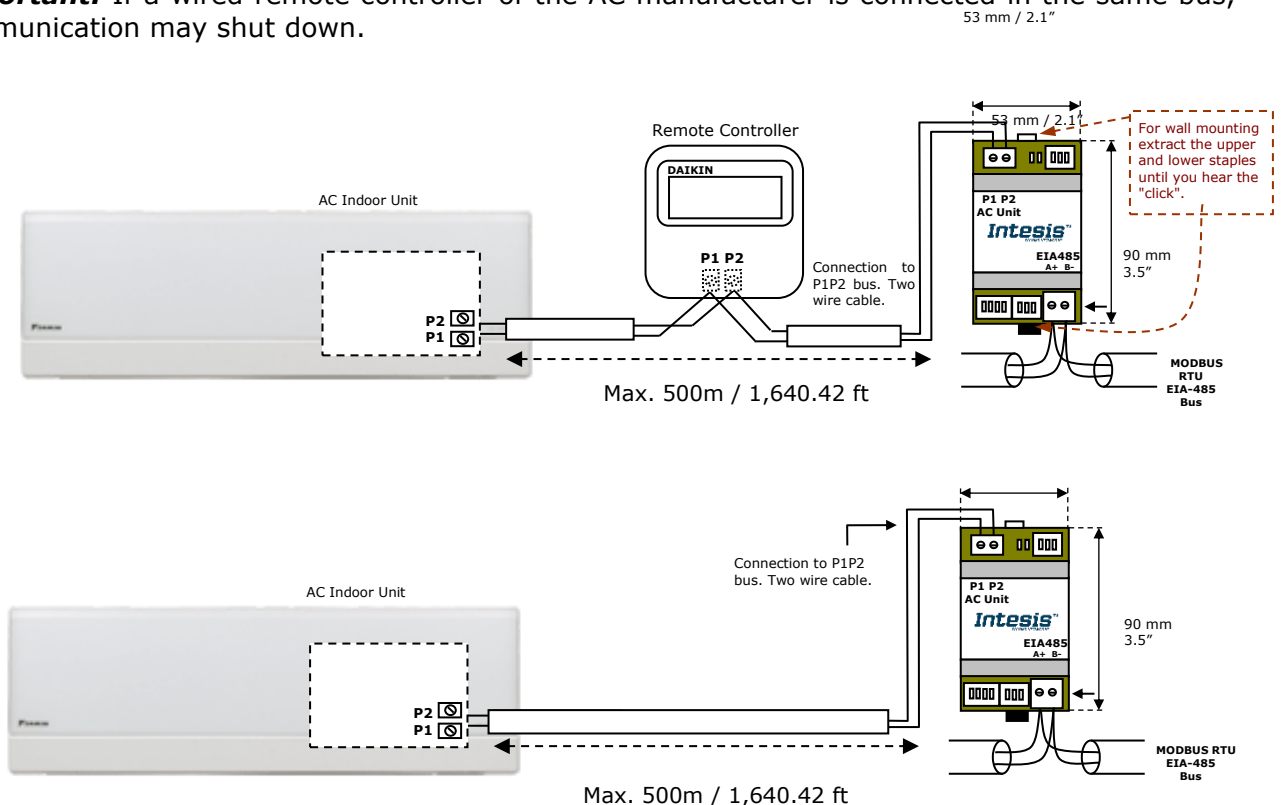

Figure 2. 1 INMBSDAI001R000 Connection diagrams

2.2 Connection to the EIA-485 bus

Connect the EIA-485 bus wires to the plug-in terminal block (the one of two poles) of INMBSDAI001R000 and keep the polarity on this connection (A+ and B-). Make sure that the maximum distance to the bus is 1,200 meters (3,937 ft). Loop or star typologies are not allowed in the case of the EIA-485 bus. A terminator resistor of 120Ω must be present at each end of the bus to avoid signal reflections. The bus needs a fail-safe biasing mechanism (see section 4.6 for more details).

3. Quick Start Guide

1. Disconnect the air conditioning from the Mains Power.
2. Attach the interface next to the AC indoor unit (wall mounting) following the instructions of the diagram below or install it inside the AC indoor unit (respect the safety instructions given).
3. Connect the P1P2 bus between the interface and the AC indoor unit following the instructions of the diagram. Screw each bare cable end in the corresponding P1P2 terminals of each device.
4. Connect the EIA-485 bus to the connector *EIA485* of the interface.
5. Close the AC indoor unit.
6. Check the DIP-Switch configuration of the Intesis interface and make sure it matches the current installation's parameters (see section 4.3).

By default, the interface is set to:

- Modbus Slave Address → 1
- Modbus baud rate → 9600 bps



These parameters can be modified from SW4 and SW3 DIP-Switches.

All other switch positions are set at low level (Off position ) by default.

NOTE: All changes on the DIP-Switch configuration require a system power cycle to be applied.

7. Connect the AC system to Mains Power.

IMPORTANT: The Intesis interface requires to be connected to the AC unit (powered) to start communicating.

4. Modbus Interface Specification

4.1 Modbus physical layer

INMBSDAI001R000 implements a Modbus RTU (Slave) interface, to be connected to an EIA-485 line. It performs 8N2 communication (8 data bits, no parity and 2 stop bit) with several available baud rates (2400 bps, 4800 bps, 9600 bps -default-, 19200 bps, 38400 bps, 57600 bps, 76800 bps and 115200 bps). It also supports 8N1 communication (8 data bits, no parity and 1 stop bit).

4.2 Modbus Registers

All registers are type "16-bit unsigned Holding Register" and they use the standard *Modbus big endian* notation.

4.2.1 Control and status registers

Register Address (protocol address)	Register Address (PLC address)	R/W	Description
0	1	R/W	AC unit On/Off <ul style="list-style-type: none"> ▪ 0: Off ▪ 1: On
1	2	R/W	AC unit Mode ¹ <ul style="list-style-type: none"> ▪ 0: Auto ▪ 1: Heat ▪ 2: Dry ▪ 3: Fan ▪ 4: Cool
2	3	R/W	AC unit Fan Speed ¹ <ul style="list-style-type: none"> ▪ 0: Auto ▪ 1: Low ▪ 2: Mid ▪ 3: High
3	4	R/W	AC unit Vane Position ¹ <ul style="list-style-type: none"> ▪ 1: Position-1 (Horizontal) ▪ 2: Position-2 (Horizontal) ▪ 3: Position-3 (Medium) ▪ 4: Position-4 (Vertical) ▪ 5: Position-5 (Vertical) ▪ 10: Swing
4	5	R/W	AC unit Temperature Setpoint ^{1,2,3} <ul style="list-style-type: none"> ▪ -32768 (Initialization value) ▪ 16..31°C (°C/x10°C) ▪ 61..92°F
5	6	R	AC unit Temperature reference ^{1,2,3} <ul style="list-style-type: none"> ▪ -32768 (Initialization value) ▪ 10..38°C (°C/x10°C) ▪ 50..100°F

¹ Available values will depend on the AC unit mode. Check the AC unit model functions in its user manual to know the possible values for this register.

² Magnitude for this register can be adjusted to Celsius x 10°C, Celsius x 100°C (default) or Fahrenheit. See section 0 for more information.

³ It is not possible turn to x10 the value shown in Fahrenheit.

Register Address (protocol address)	Register Address (PLC address)	R/W	Description
6	7	R/W	Window Contact <ul style="list-style-type: none"> 0: Closed (Default) 1: Open
7	8	R/W	INMBSDAI001R000 Disablement ⁴ <ul style="list-style-type: none"> 0: INMBSDAI001R000 enabled (Default value) 1: INMBSDAI001R000 disabled
8	9	R/W	AC Remote Control Disablement ⁴ <ul style="list-style-type: none"> 0: Remote Control enabled (Default value) 1: Remote Control disabled
9	10	R/W	AC unit Operation Time ⁴ <ul style="list-style-type: none"> 0..65535 (hours). Counts the time the AC unit is in "On" state.
10	11	R	AC unit Alarm Status <ul style="list-style-type: none"> 0: No alarm condition 1: Alarm condition
11	12	R	Error Code ⁵ <ul style="list-style-type: none"> 0: No error present 65535(-1 if it is read as signed value): Error in the communication of INMBSDAI001R000 with the AC unit. Any other error present, see the table at the end of this document.
22	23	R/W	Indoor unit's ambient temperature from external sensor (at Modbus side) ^{1,2,3,6,7} <ul style="list-style-type: none"> -32768: (Initialization value). No temperature is being provided from an external sensor. Any other: (°C/x10°C/°F)
23	24	R	AC Real temperature setpoint ^{1,2,3,6} <ul style="list-style-type: none"> When no external temperature is provided, this read-only register will have the same value as register 5 (PLC addressing). In all cases, it will show the current setpoint in the indoor unit. 16..31°C (°C/x10°C) 60..90°F
26	27	R/W	AC unit Horizontal Vane Position ¹ <ul style="list-style-type: none"> 0: Auto (Default Value) 10: Swing
55	56	R/W	Under voltage counter ¹ <ul style="list-style-type: none"> 0..300
97	98	R/W	Block Periodic Sendings ^{4,8,9} <ul style="list-style-type: none"> 0: Non-blocked (Default value) 1: Blocked

⁴ This value is stored in non-volatile memory

⁵ See section 7 for possible error codes and their explanation

⁶ See section 0 for more information

⁷ This register is available in firmware version 0.8 onwards

⁸ If the register is configured as "0: Non-blocked", all commands received from Modbus will be sent to the AC system. If "1: Blocked", commands from Modbus will only be sent to the AC system if they differ from the previous value.

⁹ This register applies to firmware version 1.6 onwards

4.2.2 Configuration Registers

Register Address (protocol address)	Register Address (PLC address)	R/W	Description
13	14	R/W	"Open Window" switch-off timeout ¹⁰ <ul style="list-style-type: none"> ▪ 0..30 (minutes) ▪ Factory setting: 30 (minutes)
14	15	R	Modbus RTU baud-rate <ul style="list-style-type: none"> ▪ 2400bps ▪ 4800bps ▪ 9600bps (Default) ▪ 19200bps ▪ 38400bps ▪ 57600bps ▪ 76800bps ▪ 115200bps
15	16	R	Modbus Slave Address <ul style="list-style-type: none"> ▪ 1..63
21	22	R	Max number of fan speeds
48	49	R	Switch value
49	50	R	Device ID: 0x0801
50	51	R	Software version
81	82	R	Error address <ul style="list-style-type: none"> ▪ Provides the indoor unit's number which is showing the error

¹⁰ Once window contact is open, a count-down to switch off the AC Unit will start from this configured value.

4.2.3 Considerations on Temperature Registers

- **AC unit temperature setpoint (R/W)**
(register 4 – in Protocol address / register 5 – in PLC address):
This is the adjustable temperature setpoint value that must be required by the user. This register can be read (Modbus function 3 or 4) or written (Modbus functions 6 or 16). A remote controller connected to the Daikin indoor unit will report the same temperature setpoint value as this register, unless virtual temperature is applied.
- **AC unit temperature reference (R)**
(register 5 – in Protocol address / register 6 – in PLC address):
This register reports the temperature that is currently used by the Daikin indoor unit as the reference of its own control loop. Depending on the configuration of the indoor unit, this value can be the temperature reported by the sensor on the return path of the Daikin indoor unit or the sensor of its remote controller. It is a read-only register (Modbus functions 3 or 4).
- **AC unit external temperature reference (Modbus) (R/W)**
(register 22 – in Protocol address / register 23 – in PLC address):
This register allows us to provide an external temperature's sensor from the Modbus side. If an external temperature is provided through this register, indoor unit will use it as reference for its temperature control loop.
 - For this temperature to take effect it is required that:
 - a) The Daikin AC indoor unit is configured in such a way that it uses the "thermostat sensor in the remote controller" (this is, INMBSDAI001R000 will act as thermostat sensor providing a temperature sensor reading). This configuration is done via a Daikin remote controller connected to the indoor unit (Config mode "10" – first code value "2" – second code value "1") and must be done by Daikin authorized installers at the time of the installation of the AC.
Moreover, the DIP Switch SW1-P4 needs to be set as "*Daikin Remote Controller ambient temperature reading*" (On position).
 - b) INMBSDAI001R000 is set as "master" of P1P2 bus, with respect to an additional remote controller in the bus (see section "2.1 Connection to the AC indoor unit" and "4.3 DIP-Switch Configuration Interface")
 - Register value after INMBSDAI001R000 startup is -32768, which means that no temperature reference is provided to the AC indoor unit. In that case, AC indoor unit will use its own return path temperature sensor as reference for its control loop.

In case the INMBSDAI001R000 is **set as Master**, DIP-Switch SW1-P4 is set as "*Daikin Indoor Unit ambient temperature reading (Default value)*" (Off position) and consequently the Daikin AC indoor unit is set to use its own return path temperature, any value written in this register will not take effect.

In case the INMBSDAI001R000 is **set as Slave** and there is a write request from the Modbus master to register 22/23, "Virtual temperature" will apply:

$$S_{AC} = S_u - (T_u - T_{AC})$$

Where:

- S_{AC} - setpoint value currently applied to the indoor unit
- S_u - setpoint value written at Modbus side (register 4/5)
- T_u - external temperature reference written at Modbus side (register 22/23)
- T_{AC} - ambient temperature that the indoor unit is using as the reference of its own control loop (register 5/6)

When INMBSDAI001R000 detects a change in any of the values of $\{ S_u, T_u, T_{AC} \}$, it will send the new setpoint (S_{AC}) to the indoor unit.

- Once values have been entered in the "AC unit external temperature's reference" (register 22/23) and "AC unit temperature set point" (register 4/5), INMBSDAI001R000 is going to estimate the temperature chosen implied (e.g. if a "temperature setpoint (register 4/5)" of **22°C**, and an "external temperature reference (register 22/23)" of **20°C** are entered, INMBSDAI001R000 will assume that the user is demanding a **+2°C** increase in temperature).
 - By knowing at any time, the ambient temperature currently used by the indoor unit to control its own operation (register 5/6), INMBSDAI001R000 can calculate the required temperature setpoint needed to apply the decrease/increase on the real temperature and reach the temperature chosen by the user (following the example above, if INMBSDAI001R000 reads an "ambient temperature" (register 5/6) of **24°C** in the indoor unit, it will apply a final setpoint of **24°C + 2°C = 26°C**).
 - At this moment, each time that INMBSDAI001R000 detects a change on the ambient temperature reported by the indoor unit (register 5/6), it will also change the required setpoint, in order to keep the temperature required by the user at any time. If we follow the last example, if INMBSDAI001R000 receives a new temperature's value coming from the indoor unit of **25°C**, INMBSDAI001R000 will automatically adjust the temperature setpoint required of the AC indoor unit to **25°C + 2°C = 27°C**).
 - After the startup, the value for "external temperature's reference" (register 22/23) has a value -32768 (0x8000). This value means that no external temperature reference is being provided through INMBSDAI001R000. In this scenario, the setpoint value shown in register 4/5 is always the same as the current setpoint value of the indoor unit. The AC indoor unit will use its own return path temperature sensor as reference for its control loop.
 - When the mechanism of "Virtual Temperature" is applied, the temperature setpoint's value shown by the Remote Controller or other Control System from Daikin connected to the indoor unit may show a different value from the value shown in register 4/5.
- **AC Real temperature setpoint (R)**
(register 23 – In Protocol address / register 24 – in PLC address):
As it has been detailed on the previous point, the real temperature setpoint in the indoor unit and the temperature setpoint requested from INMBSDAI001R000 might differ (when a value in register 22/23 – "external temperature reference" is entered and virtual temperature is applied).

This register always informs about the current temperature setpoint which is being used by the indoor unit and it also includes the temperature setpoint that will be shown by an additional remote controller from Daikin connected to the indoor unit, if it is present on the system.

This register will show the same value as **AC unit temperature setpoint** register (register 23 – In Protocol address / register 24 – in PLC address) if no virtual temperature is applied.

Moreover, notice that temperature's values of all these four registers are expressed according to the temperature's format configured through its onboard DIP-Switches (See "4.3 DIP-switch Configuration Interface").

These following formats are possible:

- **Celsius value:** Value in Modbus register is the temperature value in Celsius (i.e. a value "22" in the Modbus register must be interpreted as 22°C)
- **Decicelsius value:** Value in Modbus register is the temperature value in decicelsius (i.e. a value "220" in the Modbus register must be interpreted as 22.0°C)
- **Fahrenheit value:** Value in Modbus register is the temperature value in Fahrenheit (i.e. a value "72" in the Modbus register must be interpreted as 72°F (~22°C)).

4.3 DIP-switch Configuration Interface

All the configuration values on INMBSDAI001R000 can be written and read from Modbus interface. Otherwise, some of them can also be setup from its on-board DIP-switch interface. The device has DIP-switches SW1, SW3 and SW4 on the following locations:

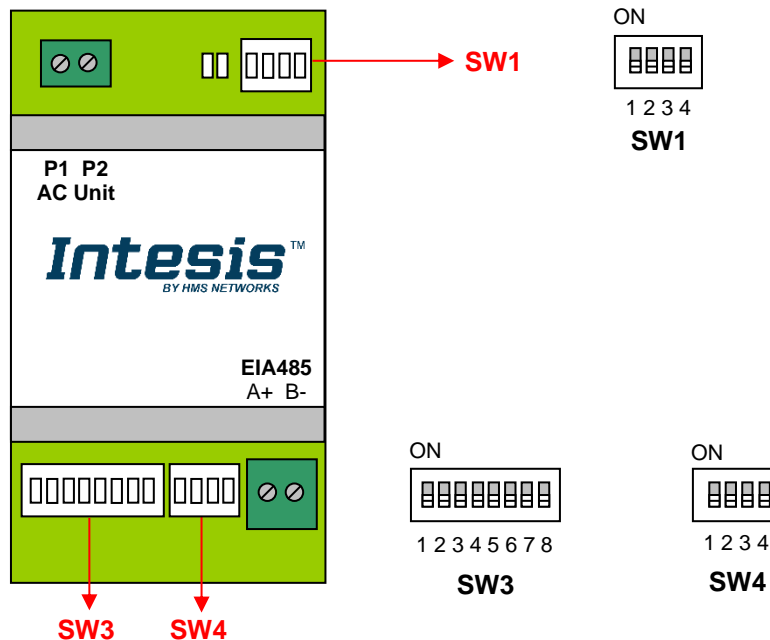

The following tables apply to the interface's configuration through DIP-switches:

SW1 – AC indoor unit's features

SW1-P1..4	Description
	Slave - A Daikin BRC Controller must be present in P1P2 bus, configured as Master (Default value)
	Master - Daikin BRC Controller not needed in P1P2 bus. If it exists, it must be configured as Slave
	Master of Operation Mode (For VRV only)
	Slave of Operation Mode (For VRV only) (Default value) ¹¹
	Reserved, not used (Default value)
	Reserved, not used
	Daikin Indoor Unit ambient temperature reading (Default value) ¹²
	Daikin Remote Controller ambient temperature reading

Table 4.1 SW1: AC indoor unit's features

¹¹ Explanation in Section 8 of this document

¹² From firmware version 1.2 onwards

SW3/SW4 – Baud rate configuration

















SW3-P7..8	SW4-P3	Description
		2400bps
		4800bps
		9600bps (Default value)
		19200bps
		38400bps
		57600bps
		76800bps
		115200bps

Table 4.2 SW3-SW4: Modbus baud rate

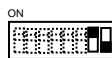
SW4 – Degrees/Decidegrees (x10), temperature magnitude (°C/°F) and EIA-485 termination resistor.

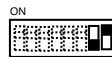





SW4-P1..2-4	Description
	Temperature values in Modbus register are represented in degrees (x1) (Default value)
	Temperature values in Modbus register are represented in decidegrees (x10)
	Temperature values in Modbus register are represented in Celsius degrees (Default value)
	Temperature values in Modbus register are represented in Fahrenheit degrees
	EIA-485 bus without termination resistor (Default value)
	Internal termination resistor of 120Ω connected to EIA-485 bus

Table 4.3 SW4: Temperature and termination resistor configuration

SW3 – Modbus Slave address

Add	SW3-P1..6	Add	SW3-P1..6	Add	SW3-P1..6	Add	SW3-P1..6	Add	SW3-P1..6
0		13		26		39		52	
1		14		27		40		53	
2		15		28		41		54	
3		16		29		42		55	
4		17		30		43		56	
5		18		31		44		57	
6		19		32		45		58	
7		20		33		46		59	
8		21		34		47		60	
9		22		35		48		61	
10		23		36		49		62	
11		24		37		50		63	
12		25		38		51			

Table 4.4 SW3: Modbus slave address

4.4 Implemented Functions

INMBSDAI001R000 implements the following standard Modbus functions:

- 3: Read Holding Registers
- 4: Read Input Registers
- 6: Write Single Register
- 16: Write Multiple Registers (Despite this function is allowed, the interface does not allow to write operations on more than 1 register with the same request, this means that length field should be always be 1 when this function is being used in case of writing)

4.5 Device LED indicator

The device includes two LED indicators to show all the possible operational states. In the following table there are written the indicators which can be performed and their meaning.

L1 (green LED)

Device status	LED indication	ON / OFF Period	Description
During not normal operation	LED blinking	500ms ON / 500ms OFF	Communication error
During normal operation	LED flashing	100ms ON / 1900ms OFF	Normal operation (configured and working properly)

L2 (red LED)

Device status	LED indication	ON / OFF Period	Description
During not normal operation	LED Pulse	3sec ON / --- OFF	Under voltage

L1 (green LED) & L2 (red LED)

Device status	LED indication	ON / OFF Period	Description
During normal operation	LED Pulse	5sec ON / --- OFF	Device Start-up
During not normal operation	LED alternatively blinking	500ms ON / 500ms OFF	Flash checksum not OK

4.6 EIA-485 bus. Termination resistors and Fail-Safe Biasing mechanism

EIA-485 bus requires a 120Ω terminator resistor at each end of the bus to avoid signal reflections.

In order to prevent fail status detected by the receivers, which are "*listening*" the bus, when all the transmitters' outputs are in three-state (high impedance), it is also required a fail-safe biasing mechanism. This mechanism provides a safe status (a correct voltage level) in the bus when all the transmitters' outputs are in three-state. This mechanism must be supplied by the Modbus Master.

The INMBSDAI001R000 device includes an on-board terminator resistor of 120Ω that can be connected to the EIA-485 bus by using DIP-switch SW4.

Some Modbus RTU EIA-485 Master devices can provide also internal 120Ω terminator resistor and/or fail-safe biasing mechanism (check the technical documentation of the Master device connected to the EIA-485 network in each case).

5. Electrical and Mechanical features

Enclosure	Plastic, type PC (UL 94 V-0) Net dimensions (dxwxh): 93 x 53 x 58 mm / 3.7" x 2.1" x 2.3" Color: Light Grey. RAL 7035	Operation Temperature	0°C to +60°C
Weight	85 g.	Stock Temperature	-20°C to +85°C
Mounting	Wall DIN rail EN60715 TH35.	Operational Humidity	<95% RH, non-condensing
Terminal Wiring (for low-voltage signals)	For terminal: solid wires or stranded wires (twisted or with ferrule) 1 core: 0.5mm ² ... 2.5mm ² 2 cores: 0.5mm ² ... 1.5mm ² 3 cores: not permitted	Stock Humidity	<95% RH, non-condensing
Modbus RTU port	1 x Serial EIA485 Plug-in screw terminal block (2 poles): A, B Compatible with Modbus RTU EIA-485 networks	Isolation voltage	1500 VDC
AC unit port	1 x P1P2 bus Plug-in screw terminal block (2 poles): P1, P2 Compatible with Daikin networks	Isolation resistance	1000 MΩ
Switch 1 (SW1)	1 x DIP-Switch for AC features	Protection	IP20 (IEC60529)
Switch 3 (SW3)	1 x DIP-Switch for Modbus RTU settings	LED indicators	2 x Onboard LED - Operational status
Switch 4 (SW4)	1 x DIP-Switch for extra functions		

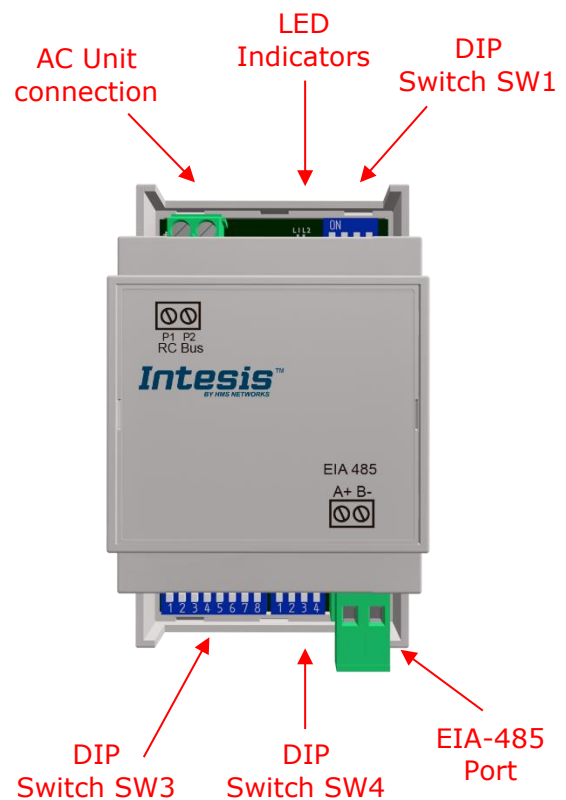
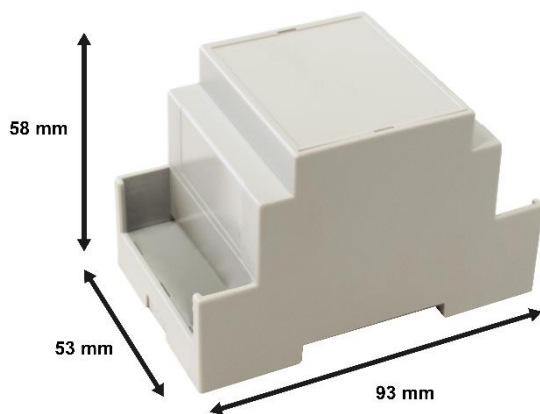

6. List of supported AC Unit Types.

A list of Daikin indoor unit model's references compatible with INMBSDAI001R000 and its available features can be found on this link:

https://www.intesis.com/docs/compatibilities/inxxdai001rx00_compatibility

7. Error Codes

Error Code Modbus	Error in Remote Controller	Error category	Error Description
0	N/A	INMBSDAI001R000	No active error
17	A0	Indoor Unit	External protection devices activated
18	A1		Indoor unit PCB assembly failure
19	A2		Interlock error for fan
20	A3		Drain level system error
21	A4		Temperature of heat exchanger (1) error
22	A5		Temperature of heat exchanger (2) error
23	A6		Fan motor locked, overload, over current
24	A7		Swing flap motor error
25	A8		Overcurrent of AC input
26	A9		Electronic expansion valve drive error
27	AA		Heater overheat
28	AH		Dust collector error / No-maintenance filter error
30	AJ		Capacity setting error (indoor)
31	AE		Shortage of water supply
32	AF		Malfunctions of a humidifier system (water leaking)
33	C0		Malfunctions in a sensor system
36	C3		Sensor system of drain water error
37	C4		Heat exchanger (1) (Liquid pipe) thermistor system error
38	C5		Heat exchanger (1) (Gas pipe) thermistor system error
39	C6		Sensor system error of fan motor locked, overload
40	C7		Sensor system of swing flag motor error
41	C8		Sensor system of over-current of AC input
42	C9		Suction air thermistor error
43	CA		Discharge air thermistor system error
44	CH		Contamination sensor error
45	CC		Humidity sensor error
46	CJ		Remote control thermistor error
47	CE		Radiation sensor error
48	CF	High pressure switch sensor	
49	E0	Outdoor Unit	Protection devices activated
50	E1		Outdoor unit PCB assembly failure
52	E3		High pressure switch (HPS) activated
53	E4		Low pressure switch (LPS) activated
54	E5		Overload of inverter compressor motor
55	E6		Over current of STD compressor motor
56	E7		Overload of fan motor / Over current of fan motor
57	E8		Over current of AC input
58	E9		Electronic expansion valve drive error
59	EA		Four-way valve error
60	EH		Pump motor over current
61	EC		Water temperature abnormal
62	EJ		(Site installed) Protection device activated
63	EE		Malfunctions in a drain water
64	EF		Ice thermal storage unit error
65	H0		Malfunctions in a sensor system
66	H1		Air temperature thermistor error
67	H2		Sensor system of power supply error
68	H3		High Pressure switch is faulty

69	H4		Low pressure switch is faulty
70	H5		Compressor motor overload sensor is abnormal
71	H6		Compressor motor over current sensor is abnormal
72	H7		Overload or over current sensor of fan motor is abnormal
73	H8		Sensor system of over-current of AC input
74	H9	Outdoor Unit	Outdoor air thermistor system error
75	HA		Discharge air thermistor system error
76	HH		Pump motor sensor system of over current is abnormal
77	HC		Water temperature sensor system error
79	HE		Sensor system of drain water is abnormal
80	HF		Ice thermal storage unit error (alarm)
81	F0		No.1 and No.2 common protection device operates.
82	F1		No.1 protection device operates.
83	F2		No.2 protection device operates
84	F3		Discharge pipe temperature is abnormal
87	F6		Temperature of heat exchanger (1) abnormal
91	FA		Discharge pressure abnormal
92	FH		Oil temperature is abnormally high
93	FC		Suction pressure abnormal
95	FE		Oil pressure abnormal
96	FF		Oil level abnormal
97	J0		Sensor system error of refrigerant temperature
98	J1		Pressure sensor error
99	J2		Current sensor error
100	J3		Discharge pipe thermistor system error
101	J4		Low pressure equivalent saturated temperature sensor system error
102	J5		Suction pipe thermistor system error
103	J6		Heat exchanger (1) thermistor system error
104	J7		Heat exchanger (2) thermistor system error
105	J8		Oil equalizer pipe or liquid pipe thermistor system error
106	J9	Double tube heat exchanger outlet or gas pipe thermistor system error	
107	JA	Discharge pipe pressure sensor error	
108	JH	Oil temperature sensor error	
109	JC	Suction pipe pressure sensor error	
111	JE	Oil pressure sensor error	
112	JF	Oil level sensor error	
113	L0	Inverter system error	
116	L3	Temperature rise in a switch box	
117	L4	Radiation fin (power transistor) temperature is too high	
118	L5	Compressor motor grounded or short circuit, inverter PCB fault	
119	L6	Compressor motor grounded or short circuit	
120	L7	Over current of all inputs	
121	L8	Compressor over current, compressor motor wire cut	
122	L9	Stall prevention error (start-up error) Compressor locked, etc.	
123	LA	Power transistor error	
125	LC	Communication error between inverter and outdoor control unit	

129	P0		Shortage of refrigerant (thermal storage unit)
130	P1		Power voltage imbalance, open phase
132	P3		Sensor error of temperature rise in a switch box
133	P4		Radiation fin temperature sensor error
134	P5		DC current sensor system error
135	P6		AC or DC output current sensor system error
136	P7		Total input current sensor error
142	PJ		Capacity setting error (outdoor)
145	U0	System	Low pressure drop due to insufficient refrigerant or electronic expansion valve error, etc.
146	U1		Reverse phase, Open phase
147	U2		Power voltage failure / Instantaneous power failure
148	U3		Failure to carry out check operation, transmission error
149	U4		Communication error between indoor unit and outdoor unit, communication error between outdoor unit and BS unit
150	U5		Communication error between remote control and indoor unit / Remote control board failure or setting error for remote control
151	U6	System	Communication error between indoor units
152	U7		Communication error between outdoor units / Communication error between outdoor unit and ice thermal storage unit
153	U8		Communication error between main and sub remote controllers (sub remote control error) / Combination error of other indoor unit / remote control in the same system (model)
154	U9		Communication error between other indoor unit and outdoor unit in the same system / Communication error between other BS unit and indoor/outdoor unit
155	UA		Combination error of indoor/BS/outdoor unit (model, quantity, etc.), setting error of spare parts PCB when replaced
156	UH		Improper connection of transmission wiring between outdoor and outdoor unit outside control adaptor
157	UC		Centralized address duplicated
158	UJ		Attached equipment transmission error
159	UE		Communication error between indoor unit and centralized control device
160	UF		Failure to carry out check operation Indoor-outdoor, outdoor-outdoor communication error, etc.
209	60		All system error
210	61		PC board error
211	62		Ozone density abnormal
212	63		Contamination sensor error
213	64		Indoor air thermistor system error
214	65		Outdoor air thermistor system error
217	68		HVU error (Venti-air dust-collecting unit)
219	6A		Dumper system error
220	6H		Door switch error
221	6C		Replace the humidity element
222	6J		Replace the high efficiency filter

223	6E	Others	Replace the deodorization catalyst	
224	6F		Simplified remote controller error	
226	51		Fan motor of supply air over current or overload	
227	52		Fan motor of return air over current / Fan motor of return air overload	
228	53		Inverter system error (supply air side)	
229	54		Inverter system error (return air side)	
241	40		Humidifying valve error	
242	41		Chilled water valve error	
243	42		Hot water valve error	
244	43		Heat exchanger of chilled water error	
245	44		Heat exchanger of hot water error	
258	31		The humidity sensor of return air sensor	
259	32		Outdoor air humidity sensor error	
260	33		Supply air temperature sensor error	
261	34		Return air temperature sensor error	
262	35		Outdoor air temperature sensor error	
263	36		Remote controller temperature sensor error	
267	3A		Water leakage sensor 1 error	
268	3H		Water leakage sensor 2 error	
269	3C		Dew condensation error	
339	M2		Centralized remote controller PCB error	
345	M8		Communication error between centralized remote control devices	
347	MA		Centralized remote control devices inappropriate combination	
349	MC		Centralized remote controller address setting error	
65535 (-1)	N/A		INMBSDAI001R000	Error in the communication of INMBSDAI001R000 with the AC unit

In case to detect an error code not listed, contact your closest Daikin technical support service.