

WMP

Samsung NASA VRF Air Conditioning
Gateway for the integration of Samsung NASA VRF systems into Home Automation
systems (WMP)

USER MANUAL

Issue date: 09/2020 r1.0 ENGLISH

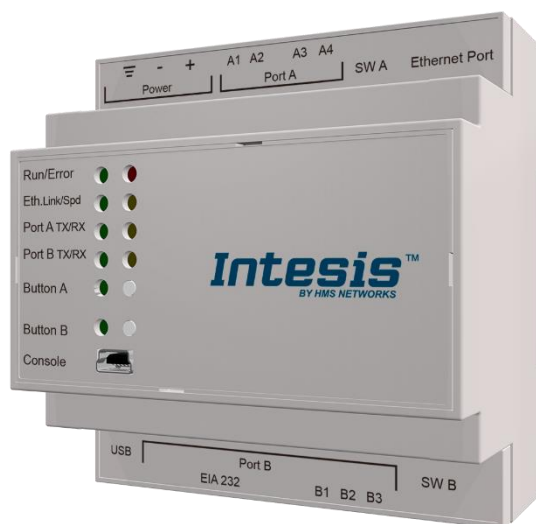

Important User Information

Disclaimer

The information in this document is for informational purposes only. Please inform HMS Industrial Networks of any inaccuracies or omissions found in this document. HMS Industrial Networks disclaims any responsibility or liability for any errors that may appear in this document.

HMS Industrial Networks reserves the right to modify its products in line with its policy of continuous product development. The information in this document shall therefore not be construed as a commitment on the part of HMS Industrial Networks and is subject to change without notice. HMS Industrial Networks makes no commitment to update or keep current the information in this document.

The data, examples and illustrations found in this document are included for illustrative purposes and are only intended to help improve understanding of the functionality and handling of the product. In view of the wide range of possible applications of the product, and because of the many variables and requirements associated with any particular implementation, HMS Industrial Networks cannot assume responsibility or liability for actual use based on the data, examples or illustrations included in this document nor for any damages incurred during installation of the product. Those responsible for the use of the product must acquire sufficient knowledge in order to ensure that the product is used correctly in their specific application and that the application meets all performance and safety requirements including any applicable laws, regulations, codes and standards. Further, HMS Industrial Networks will under no circumstances assume liability or responsibility for any problems that may arise as a result from the use of undocumented features or functional side effects found outside the documented scope of the product. The effects caused by any direct or indirect use of such aspects of the product are undefined and may include e.g. compatibility issues and stability issues.

Gateway for the integration of Samsung NASA VRF systems into Home Automation systems (WMP).

ORDER CODE	LEGACY ORDER CODE
INMBSSAM004O000	SM-ACN-MBS-4
INMBSSAM008O000	SM-ACN-MBS-8
INMBSSAM016O000	SM-ACN-MBS-16
INMBSSAM064O000	SM-ACN-MBS-64

INDEX

1. Description.....	5
1.1. Introduction	5
1.2. Functionality.....	6
1.3. Capacity of Intesis.....	6
2. Intesis WMP interface.....	7
2.1. HVAC WMP Commands supported.....	7
2.2. HVAC WMP Functions allowed	7
2.3. Link with Home Automation system.....	7
3. Connections.....	9
3.1. Power device	10
3.2. Connect to Samsung NASA VRF installation	10
3.3. Connection to Home Automation (WMP).....	10
3.4. Connection to PC (Configuration tool)	10
4. Set-up process and troubleshooting.....	11
4.1. Pre-requisites.....	11
4.2. Intesis MAPS. Configuration & monitoring tool for Intesis Home Automation (WMP) series	11
4.2.1. Connection	11
4.2.2. Configuration tab	12
4.2.3. General configuration.....	12
4.2.4. Home Automation (WMP) system configuration	12
4.2.5. Samsung NASA configuration	13
4.2.6. Signals.....	15
4.2.7. Sending the configuration to Intesis.....	15
4.2.8. Diagnostic.....	16
4.2.9. Set-up procedure	17
5. Electrical & Mechanical Features	19
6. Dimensions	20
7. AC Unit Types compatibility.....	21
8. Error codes for Indoor and Outdoor Units	22

1. Description

1.1. Introduction

This document describes the integration of Samsung NASA VRF air conditioning systems into Home Automation systems using the Home Automation (WMP) to Samsung NASA VRF communication gateway.

The aim of this integration is to monitor and control Samsung NASA air conditioning systems, remotely, from a Home Automation system. To do it so, Intesis communicates with Intesis WMP protocol, allowing controlling and update the signals requested from the Home Automation hub.

Up to 64 indoor units supported, depending on product version.

This document assumes that the user is familiar with Home Automation (WMP) and Samsung NASA technologies and their technical terms.

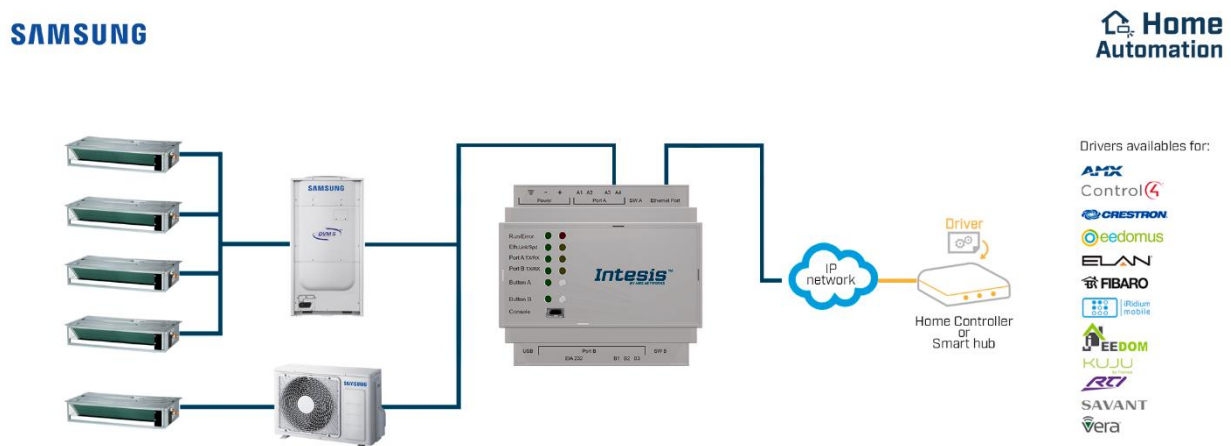

Integration of Samsung NASA compatible systems into Home Automation (WMP) systems.

1.2. Functionality

Intesis™ continuously monitors Samsung NASA VRF network for all configured signals and keeps them updated in its memory available for reading and updating them towards the Home Automation system via Intesis WMP protocol.

Commands toward the indoor units are permitted.

Each indoor unit is offered as a set of WMP commands.

Element	WMP commands supported
Indoor Unit	<ul style="list-style-type: none"> • SET (control) • CHN (status) • GET (read)

1.3. Capacity of Intesis

Element	Max.	Notes
Number of indoor units	64*	Number of indoor units that can be controlled through Intesis

* There are different models of *Intesis WMP – Samsung NASA VRF* each one with different capacity. The table above shows the capacity for the top model (with maximum capacity).

Their order codes are:

- INMBSSAM004O000, Model supporting up to 4 indoor units.
- INMBSSAM008O000, Model supporting up to 8 indoor units.
- INMBSSAM016O000, Model supporting up to 16 indoor units.
- INMBSSAM064O000, Model supporting up to 64 indoor units.

2. Intesis WMP interface

In this section, a common description for all Intesis WMP series gateways is given, from the point of view of the Home Automation system which is called from now on *internal system*. Connection with the Samsung NASA VRF system is also called from now on *external system*.

There is a specific Home Automation (WMP) manual available about WMP protocol with available examples. Here is included the specific information regarding to WMP protocol and its integration in this product, for further explanations, refer to the referred WMP manual available in www.intesis.com.

2.1. HVAC WMP Commands supported

Intesis WMP commands SET/CHN/GET can be used with the different WMP functions.

2.2. HVAC WMP Functions allowed

Depending on the signal, different commands are allowed. WMP protocol uses different functions to refer to different signals of the HVAC system.

In the table below are listed the available WMP signals for the HVAC control, the function to identify the signal, its available values and the commands allowed to interact with them.

Signals available depends on the unit type. On the left side of the table are marked the signals available for every type of unit: IU/HE/HT/EHS/AHU/ERV/ERV+.

Chiller units are not controllable from WMP protocol.

							OUTDOOR UNITS SIGNALS			
							Signal description	Function	Values	Commands
							Outdoor unit communication error	ERROROU	OK/ERR	CHN/GET
INDIVIDUAL UNITS							INDIVIDUAL UNITS			
IU	HE	HT	EHS	AHU	ERV	ERV+	Signal description	Function	Values	Commands
X	X	X	X	X		X	On/Off	ONOFF	ON/OFF	SET/CHN/GET
X	X		X	X		X	Operation Mode*	MODE	HEAT/COOL/FAN/DRY/AUTO	SET/CHN/GET
X							Fan Speed	FANSP	1/2/3/AUTO	SET/CHN/GET
X							Vane Position	VANEUD	AUTO**/SWING	SET/CHN/GET
X			X	X			Temperature Setpoint (x10) (°C)***	SETPTEMP	(°C)	SET/CHN/GET
X			X	X			AC Ambient Temperature (x10) (-35...92,5°C)***	AMBTMP	(°C)	CHN/GET
X	X	X	X	X	X	X	Unit Error code (0-No Error,X-Error)	ERRCODE	0/X (see user manual)	CHN/GET

*Modes available depends on the unit type:

- Unit type IU/AHU: HEAT/COOL/FAN/DRY/AUTO
- Unit type HE: HEAT/COOL
- Unit type EHS/ERV+: HEAT/COOL/AUTO

**AUTO is used to deactivate SWING function (swing OFF).

***For EHS these signals are available only when EHS unit is configured with optional temperature sensor = enabled (see Samsung configuration section).

2.3. Link with Home Automation system

This gateway supports one IP connection to communicate with the home automation hub or central controller but allows to communicate with several AC units. To identify the ac unit to control from the Home Automation side, WMP protocol has implemented the acnum parameter. Basically, this parameter links the home automation side identifying the AC unit to control in the AC system.

Given an AC unit, all its individual signals have one unique acnum and this number is always different among all the ac units configured in the gateway. Only in some specific cases, outdoor units might share the acnum with one indoor unit as the commands are independent between themselves.

Acnum is given in the configuration section. See [4.2.5 SAMSUNG NASA CONFIGURATION](#) for more information.

3. Connections

Find below information regarding the Intesis connections available.

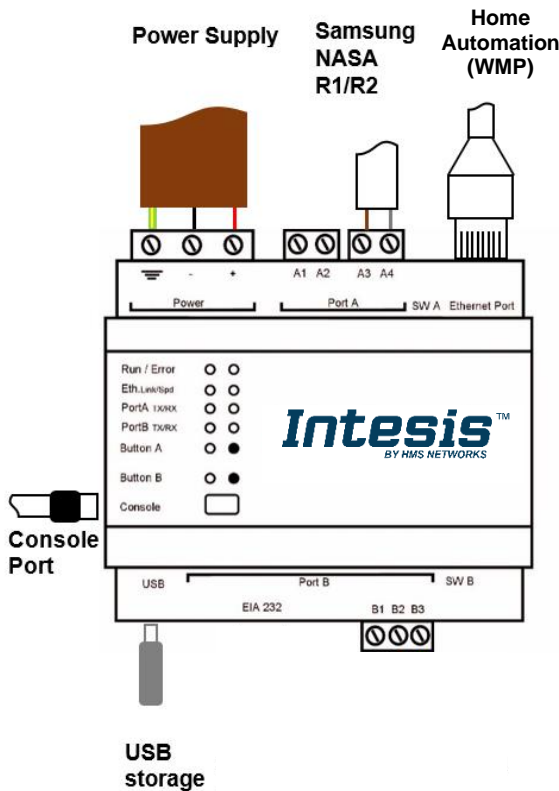

Power Supply

Must use NEC Class 2 or Limited Power Source (LPS) and SELV rated power supply.

If using DC power supply:

Respect polarity applied of terminals (+) and (-). Be sure the voltage applied is within the range admitted (check table below). The power supply can be connected to earth but only through the negative terminal, never through the positive terminal.

If using AC power supply:

Make sure the voltage applied is of the value admitted (24 Vac). Do not connect any of the terminals of the AC power supply to earth, and make sure the same power supply is not supplying any other device.

Ethernet / Home Automation (WMP) / Console (UDP & TCP)

Connect the cable coming from the IP network to the connector ETH of the gateway. Use an Ethernet CAT5 cable. If communicating through the LAN of the building, contact the network administrator and make sure traffic on the port used is allowed through all the LAN path (check the gateway user manual for more information). Default IP is 192.168.100.246. DHCP is enabled by default.

PortA / R1/R2 Samsung NASA

Connect the R1 (+) R2 (-) bus of Samsung NASA Outdoor Units to the connectors A3 (+) A4 (-) of gateway's PortA. Respect the polarity.

PortB / Free

Console Port

Connect a mini-type B USB cable from your computer to the gateway to allow communication between the Configuration Software and the gateway. Remember that Ethernet connection is also allowed. Check the user manual for more information.

USB

Connect a USB storage device (not HDD) if required. Check the user manual for more information.

Ensure proper space for all connectors when mounted (see 6 DIMENSIONS).

3.1. Power device

The first step to perform is to power up the device. To do so, a power supply working with any of the voltage range allowed is needed (check [5 ELECTRICAL & MECHANICAL FEATURES](#)). Once connected the ON led will turn on.

WARNING! To avoid earth loops that can damage the gateway, and/or any other equipment connected to it, we strongly recommend:

- The use of DC power supplies, floating or with the negative terminal connected to earth. **Never use a DC power supply with the positive terminal connected to earth.**
- The use of AC power supplies only if they are floating and not powering any other device.

3.2. Connect to Samsung NASA VRF installation

Use the PortA connector in the top corner of the Intesis device in order to connect Samsung NASA bus to the Intesis. Remember to follow all safety precautions indicated by Samsung.

To properly communicate with the Intesis, take into account the following considerations:

- Samsung NASA AC network allows for both automatic and manual addressing. **Manual addressing of both indoor and outdoor units must be setup by Samsung installer in order that Intesis communicates properly.** Manual addressing is setup by means of DIP switches in outdoor unit and using the remote controller or DIP switches in the indoor unit.
- Samsung NASA indoor units **need to be configured to accept 'central control'**. To do so, they need to be configured with so-called 'installation option code' in which segment 5 of this code needs to be set to value '1' to allow central control.

3.3. Connection to Home Automation (WMP)

The gateway's Ethernet port connection is used for the Home Automation (WMP) TCP communication. Connect the communication cable coming from the network hub or switch to the Ethernet port of Intesis. The cable to be used shall be a straight Ethernet UTP/FTP CAT5 cable.

TCP port to use (default 3310) and keep alive period must be configured.

IP settings of the gateway (DHCP status, own IP, netmask and default gateway) must be configured as well.

3.4. Connection to PC (Configuration tool)

This action allows the user to have access to configuration and monitoring of the device (more information can be found in the configuration tool User Manual). Two methods to connect to the PC can be used:

- **Ethernet:** Using the Ethernet port of Intesis.
- **USB:** Using the console port of Intesis, connect a USB cable from the console port to the PC.

4. Set-up process and troubleshooting

4.1. Pre-requisites

It is necessary to have the Home Automation system (normally a central hub) operative, configured and properly connected to the Ethernet port of the gateway and the Samsung NASA VRF installation connected to the corresponding port. Review [3.2 CONNECT TO SAMSUNG NASA VRF INSTALLATION](#) to check that all the requirements of the Samsung NASA system are set.

Connectors, connection cables, PC for the Configuration Tool usage and other auxiliary material, if needed, are not supplied by Intesis for this standard integration.

Items supplied by HMS Networks for this integration are:

- Intesis gateway.
- Link to download the configuration tool.
- USB Console cable to communicate with Intesis.
- Product documentation.

4.2. Intesis MAPS. Configuration & monitoring tool for Intesis Home Automation (WMP) series

4.2.1. Connection

To configure the Intesis connection parameters press on the **Connection** button in the *menu bar*.

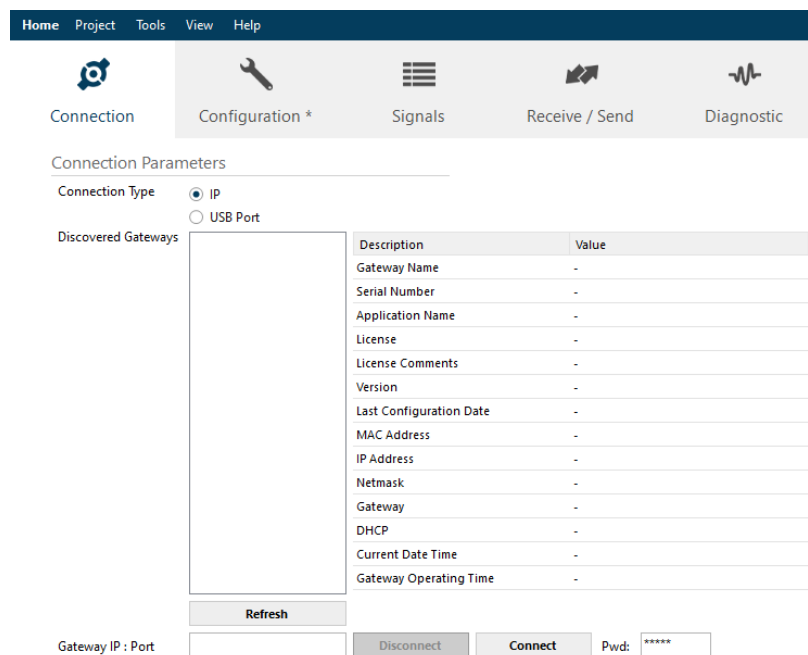

Figure 4.1 MAPS connection

4.2.2. Configuration tab

Select the **Configuration** tab to configure the connection parameters. Three subsets of information are shown in this window: General (Gateway general parameters), WMP (Home Automation system) and Samsung NASA (Samsung NASA VRF interface parameters).

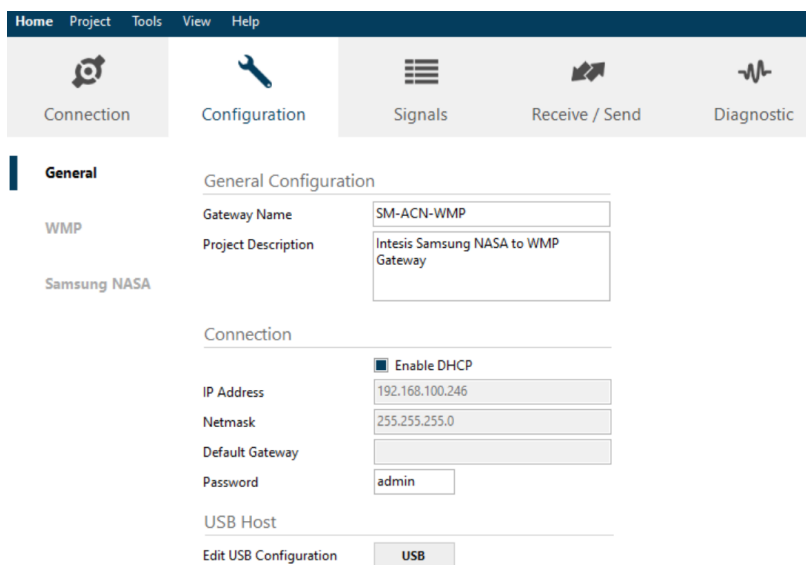

Figure 4.2 Intesis MAPS configuration tab

4.2.3. General configuration

These are the general settings of the gateway. Here you can find:

- General configuration

In this section you can include a name and description to identify the gateway.

- Connection

Here are the settings related to the IP address (via DHCP/specific IP address) and the password set for the IP configuration of the gateway in MAPS.

- USB Host

In this section it is possible to configure the different settings for the USB host port.

4.2.4. Home Automation (WMP) system configuration

These are the settings available for the Home Automation system (WMP communication):

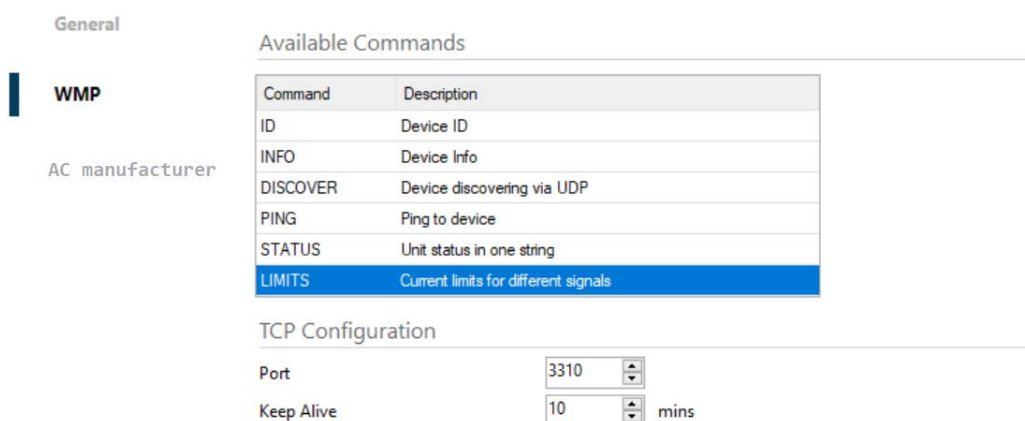

Figure 4.3 Intesis MAPS Home Automation configuration tab

1. Available commands

This is an informative section displaying all commands available for the WMP communication.

2. TCP Configuration.

This section allows to configure the TCP settings for the WMP communication with the Home Automation system.

- **Port:** WMP TCP communication port setting. Default port 3310.
- **Keep Alive.** Set the time of inactivity to send a keep Alive message. Default 10 minutes.

4.2.5. Samsung NASA configuration

Set parameters for the connection with Samsung NASA installation.

Unit ID	Unit Type	IU	OU	Optional Temp Sensor	Description
<input checked="" type="checkbox"/> Unit 1	IU	0	1	-	Indoor Unit 1
<input type="checkbox"/> Unit 2	IU	1	1	-	Indoor Unit 2
<input type="checkbox"/> Unit 3	IU	2	1	-	Indoor Unit 3
<input type="checkbox"/> Unit 4	IU	3	1	-	Indoor Unit 4
<input type="checkbox"/> Unit 5	IU	4	1	-	Indoor Unit 5
<input type="checkbox"/> Unit 6	IU	5	1	-	Indoor Unit 6
<input type="checkbox"/> Unit 7	IU	6	1	-	Indoor Unit 7
<input type="checkbox"/> Unit 8	IU	7	1	-	Indoor Unit 8

Figure 4.4 Intesis MAPS Samsung NASA configuration tab

In Units Configuration section you need to enter, for each unit:

- **Active.** If it's active (checkbox at Unit xx), ranging from 1 to 64 indoor units that will be integrated (maximum number of units will depend on Intesis model)
- **Unit type.** Type can be one of the following: IU, HE, HT, EHS, AHU, ERV, ERV+, CHILLER. Available signals will vary according to unit type. Chiller type units are not controllable with WMP protocol.
- **IU address.** Address 0..63 of Unit in Samsung NASA R1/R2 bus. Remember that manual addressing of Samsung indoor units is required.
- **OU address.** Address 0..15 of Outdoor Unit in Samsung NASA R1/R2 bus. Remember that manual addressing of Samsung indoor units is required.
- **Description.** Descriptive name to ease identification of the unit (for example, 'living room floor 1 unit', etc).

Additional to manual entry of each unit, autodiscover of present units in an R1/R2 installation is possible. To do so, click the button **Scan**. The following window will appear:

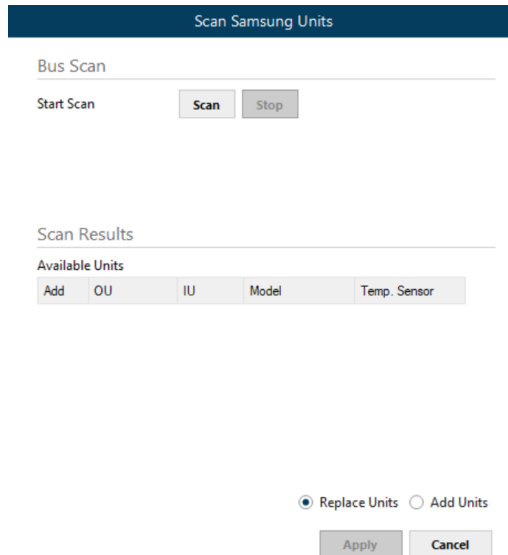

Figure 4.5 Intesis MAPS Scan Samsung Units window

By pressing the **Scan** button, connected Samsung NASA R1/R2 bus will be scanned for available units. An Error window will appear if there is a problem in the connection with R1/R2 bus (units not powered, bus not connected, ...).

A progress bar will appear during the scan, which will take up to a few minutes. After the scan is completed, the detected units will be shown in available units as follows:

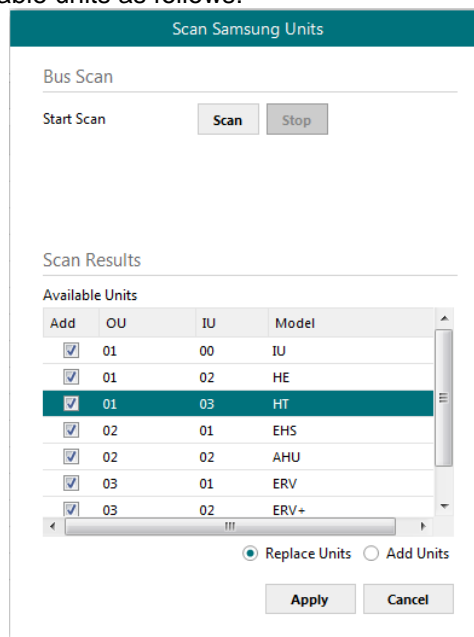

Figure 4.5 Intesis MAPS Scan Samsung Units window with scan results

Select with its checkbox units to add (or replace) in installation, according to selection **Replace Units / Add Units**. After units to be integrated are selected, click button **Apply**, and changes will appear in previous **Units Configuration** window.

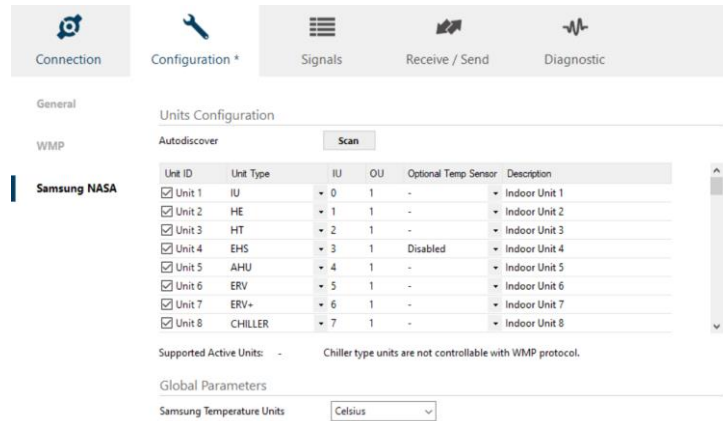

Figure 4.6 Intesis MAPS Samsung NASA configuration tab after importing scan results

Consider that Chiller unit type are detected by the SCAN or can be configured manually in this section but there are no signals available to control them from the WMP protocol.

Acnum

Acnum is the parameter or number associated to every ac unit. This parameter identifies the ac unit from the home automation side.

In this gateway, this number corresponds with the unit ID available during the configuration process. This number cannot be edited and is automatically generated during the manual or automatic (using SCAN) configuration process. You can check the indoor units Unit ID number in its column.

For the outdoor units, acnum corresponds with the lowest Unit ID of its associated indoors.

4.2.6. Signals

All available WMP signals, its corresponding description and other main parameters are listed in the signals tab. The acnum of every unit is also displayed in a column in the signals view.

#	Active	Description	WMP			Samsung NASA			
			AcNum	Format	Values	Commands	Unit ID	IU	OU
1	<input checked="" type="checkbox"/>	Outdoor unit communication error	1	ERROROU	OK/ERR	CHN/GET	-	-	1
2	<input checked="" type="checkbox"/>	On/Off	1	ONOFF	ON/OFF	SET/CHN/GET	Unit 1 - Indoor...	0	1
3	<input checked="" type="checkbox"/>	Operation Mode IU/AHU	1	MODE	HEAT/COOL/FAN/DRY/AUTO	SET/CHN/GET	Unit 1 - Indoor...	0	1
4	<input checked="" type="checkbox"/>	Fan Speed	1	FANSP	1/2/3/AUTO	SET/CHN/GET	Unit 1 - Indoor...	0	1
5	<input checked="" type="checkbox"/>	Vane Position	1	VANEUD	AUTO/SWING	SET/CHN/GET	Unit 1 - Indoor...	0	1
6	<input checked="" type="checkbox"/>	Temperature Setpoint (x10) (°C)	1	SETPTEMP	(°C)	SET/CHN/GET	Unit 1 - Indoor...	0	1
7	<input checked="" type="checkbox"/>	AC Ambient Temperature (x10)	1	AMBTMP	(°C)	CHN/GET	Unit 1 - Indoor...	0	1
8	<input checked="" type="checkbox"/>	Unit Error code (0-No Error,X-Error)	1	ERRCODE	0/X (see user manual)	CHN/GET	Unit 1 - Indoor...	0	1
9	<input checked="" type="checkbox"/>	On/Off	2	ONOFF	ON/OFF	SET/CHN/GET	Unit 2 - Indoor...	1	1
10	<input checked="" type="checkbox"/>	Operation Mode HE	2	MODE	HEAT/COOL	SET/CHN/GET	Unit 2 - Indoor...	1	1
11	<input checked="" type="checkbox"/>	Unit Error code (0-No Error,X-Error)	2	ERRCODE	0/X (see user manual)	CHN/GET	Unit 2 - Indoor...	1	1
12	<input checked="" type="checkbox"/>	On/Off	3	ONOFF	ON/OFF	SET/CHN/GET	Unit 3 - Indoor...	2	1
13	<input checked="" type="checkbox"/>	Unit Error code (0-No Error,X-Error)	3	ERRCODE	0/X (see user manual)	CHN/GET	Unit 3 - Indoor...	2	1
14	<input checked="" type="checkbox"/>	On/Off	4	ONOFF	ON/OFF	SET/CHN/GET	Unit 4 - Indoor...	3	1
15	<input checked="" type="checkbox"/>	Operation Mode EHS/ERV+	4	MODE	HEAT/COOL/AUTO	SET/CHN/GET	Unit 4 - Indoor...	3	1
16	<input checked="" type="checkbox"/>	Unit Error code (0-No Error,X-Error)	4	ERRCODE	0/X (see user manual)	CHN/GET	Unit 4 - Indoor...	3	1

Figure 4.12 Intesis MAPS Signals tab

4.2.7. Sending the configuration to Intesis

When the configuration is finished, follow the next steps.

- 1.- Save the project (Menu option **Project->Save**) on your hard disk (more information in Intesis MAPS User Manual).

2.- Go to tab 'Receive / Send' of MAPS, and in **Send** section, press **Send** button. Intesis will reboot automatically once the new configuration is loaded.

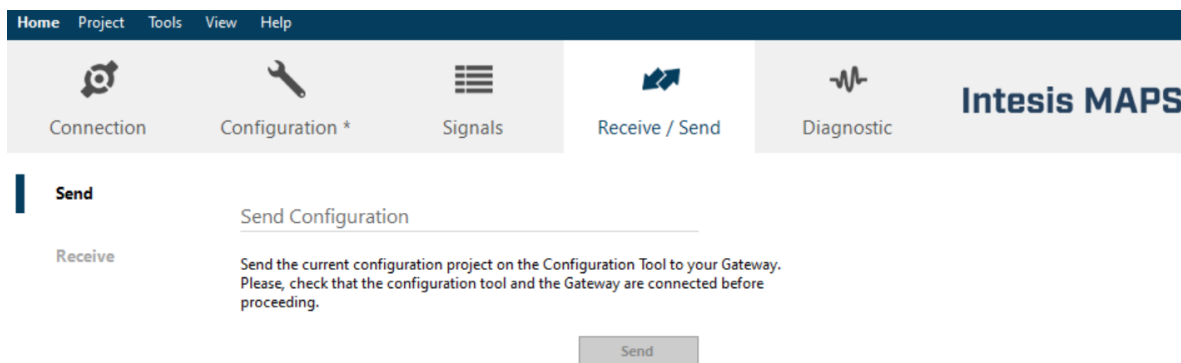

Figure 4.13 Intesis MAPS Receive/Send tab

After any configuration change, do not forget to send the configuration file to the Intesis using the Send button in the Receive / Send section.

4.2.8. Diagnostic

To help integrators in the commissioning tasks and troubleshooting, the Configuration Tool offers some specific tools and viewers.

To start using the diagnostic tools, connection with the Gateway is required.

The Diagnostic section is composed by two main parts: Tools and Viewers.

- Tools**
 Use the tools section to check the current hardware status of the box, log communications into compressed files to be sent to the support, change the Diagnostic panels' view or send commands to the gateway.
- Viewers**
 To check the status, viewer for the Internal and External protocols are available. It is also available a generic Console viewer for general information about communications and the gateway status and finally a Signals Viewer to simulate the BMS behavior or to check the current values in the system.

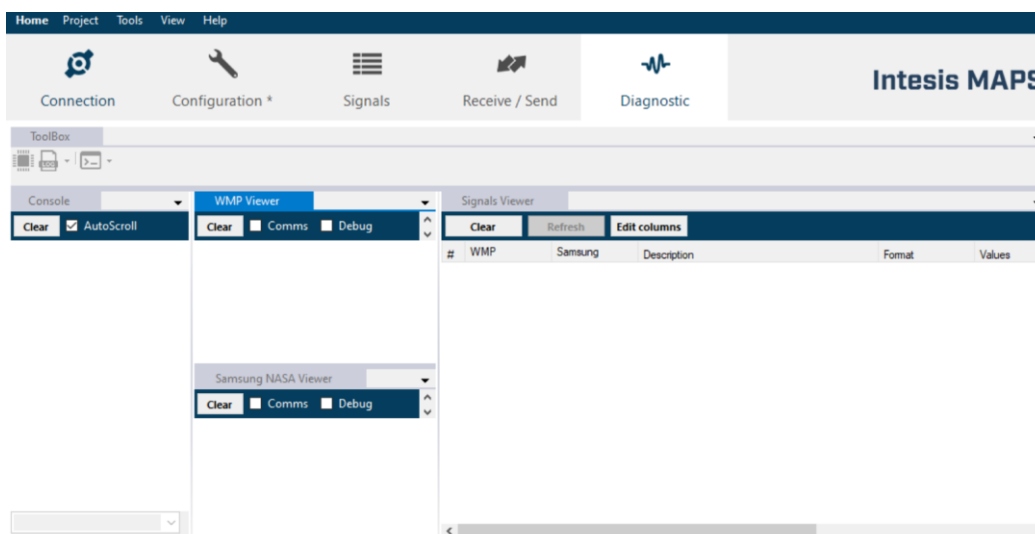

Figure 4.14 Diagnostic

More information about the Diagnostic section can be found in the Configuration Tool manual.

4.2.9. Set-up procedure

1. Install Intesis MAPS on your laptop, use the setup program supplied for this and follow the instructions given by the Installation wizard.
2. Install Intesis in the desired installation site. Installation can be on DIN rail or on a stable not vibrating surface (DIN rail mounted inside a metallic industrial cabinet connected to ground is recommended).
3. For the Home Automation (WMP) communication, connect the communication cable coming from the Ethernet port of the WMP TCP installation to the port marked as Ethernet Port of Intesis. More details in [3 CONNECTIONS](#).
4. Connect the communication cable coming from the **Samsung NASA VRF** installation to the port marked as Port A of Intesis. More connection details in [3 CONNECTIONS](#). For the Samsung NASA configuration requirements see [3.2 CONNECT TO SAMSUNG NASA VRF INSTALLATION](#).
5. Power up Intesis. The supply voltage can be 9 to 36 Vdc or just 24 Vac. Take care of the polarity of the supply voltage applied.

WARNING! To avoid earth loops that can damage Intesis and/or any other equipment connected to it, we strongly recommend:

- The use of DC power supplies, floating or with the negative terminal connected to earth. **Never use a DC power supply with the positive terminal connected to earth.**
 - The use of AC power supplies only if they are floating and not powering any other device.
6. If you want to connect using IP, connect the Ethernet cable from the laptop PC to the port marked as Ethernet of Intesis. More details in [3 CONNECTIONS](#).

If you want to connect using USB, connect the USB cable from the laptop PC to the port marked as Console of Intesis. More details in [3 CONNECTIONS](#).
 7. Open Intesis MAPS, create a new project selecting a copy of the one named IBOX-WMP-SM-Template.
 8. Modify the configuration as desired, save it and download the configuration file to Intesis as explained in the Intesis MAPS user manual.
 9. Visit the Diagnostic section, enable COMMS () and check that there is communication activity, some TX frames and some other RX frames. This means that the communication with the Home Automation hub or controller is OK. In case there is no communication activity between Intesis and the Home Automation hub or controller, check that those are operative: check the baud rate, the communication cable used to connect all devices and any other communication parameter.

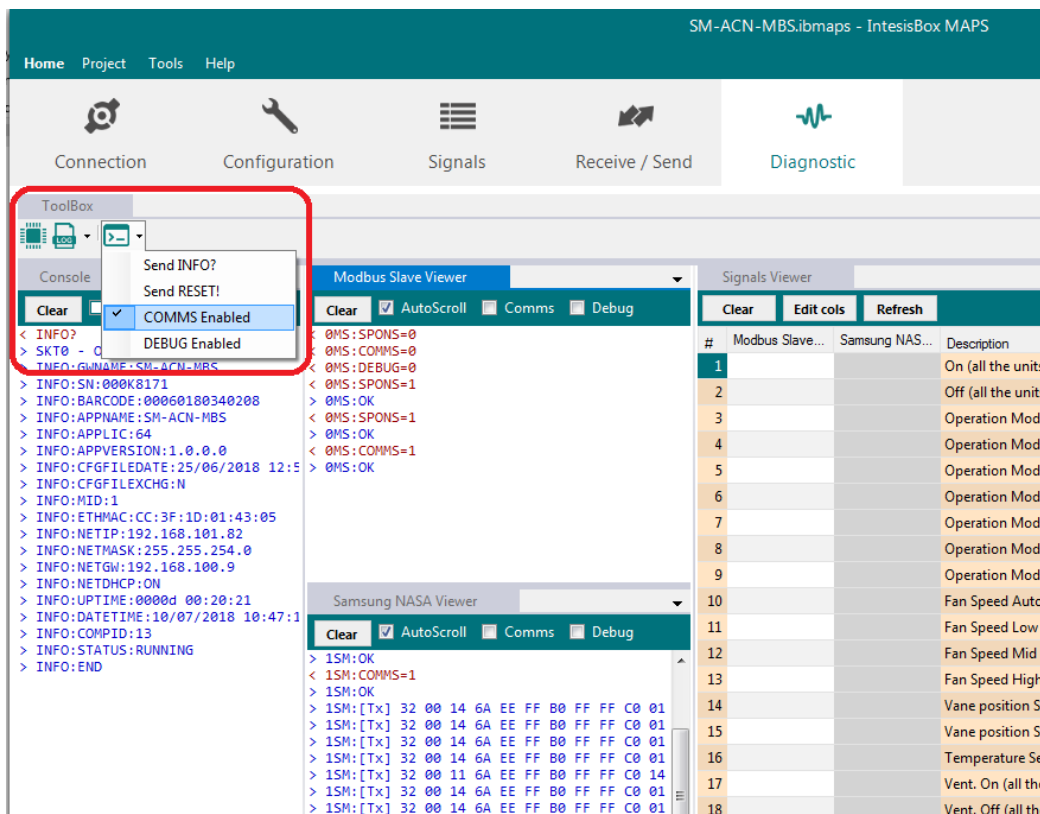

Figure 4.15 Enable COMMS

5. Electrical & Mechanical Features



Enclosure	Plastic, type PC (UL 94 V-0) Net dimensions (d×w×h): 90x88x56 mm Recommended space for installation (d×w×h): 130x100x100mm Color: Light Grey. RAL 7035	Battery	Size: Coin 20mm x 3.2mm Capacity: 3V / 225mAh Type: Manganese Dioxide Lithium
Mounting	Wall. DIN rail EN60715 TH35.	Console Port	Mini Type-B USB 2.0 compliant 1500VDC isolation
Terminal Wiring (for power supply and low-voltage signals)	Per terminal: solid wires or stranded wires (twisted or with ferrule) 1 core: 0.5mm ² ... 2.5mm ² 2 cores: 0.5mm ² ... 1.5mm ² 3 cores: not permitted If cables are more than 3.05 meters long, Class 2 cable is required.	USB port	Type-A USB 2.0 compliant Only for USB flash storage device (USB pen drive) Power consumption limited to 150mA (HDD connection not allowed)
Power	1 x Plug-in screw terminal block (3 poles) 9 to 36VDC +/-10%, Max.: 140mA 24VAC +/-10% 50-60Hz, Max.: 127mA Recommended: 24VDC	Push Button	Button A: Not used Button B: Not used
Ethernet	1 x Ethernet 10/100 Mbps RJ45 2 x Ethernet LED: port link and activity	Operation Temperature	0°C to +60°C
Port A	1 x Samsung NASA port Plug-in screw terminal block orange (2 poles) R1 R2 (Samsung Nasa) 1500VDC isolation from other ports 1 x Plug-in screw terminal block green (2 poles) Reserved for future use	Operational Humidity	5 to 95%, no condensation
Switch A (SWA)	1 x DIP-Switch for EIA485 configuration: Reserved for future use	Protection	IP20 (IEC60529)
PORT B	1 x Serial EIA232 (SUB-D9 male connector) Pinout from a DTE device 1500VDC isolation from other ports (except PORT B: EIA485) 1 x Serial EIA485 Plug-in screw terminal block (3 poles) A, B, SGND (Reference ground or shield) 1500VDC isolation from other ports (except PORT B: EIA232)	LED Indicators	10 x Onboard LED indicators 2 x Run (Power)/Error 2 x Ethernet Link/Speed 2 x Port A TX/RX 2 x Port B TX/RX 1 x Button A indicator 1 x Button B indicator
Switch B (SWB)	1 x DIP-Switch for serial EIA485 configuration: Position 1: ON: 120 Ω termination active Off: 120 Ω termination inactive (default) Position 2-3: ON: Polarization active Off: Polarization inactive (default)		

6. Dimensions

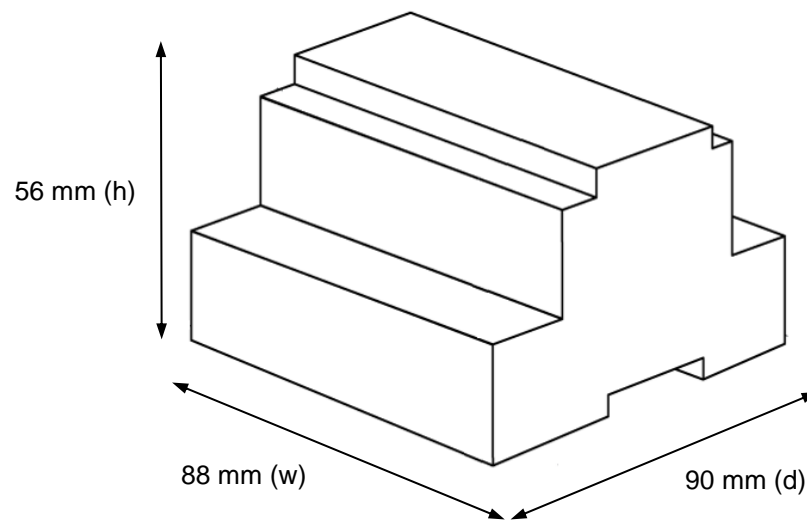

Recommended available space for its installation into a cabinet (wall or DIN rail mounting), with space enough for external connections

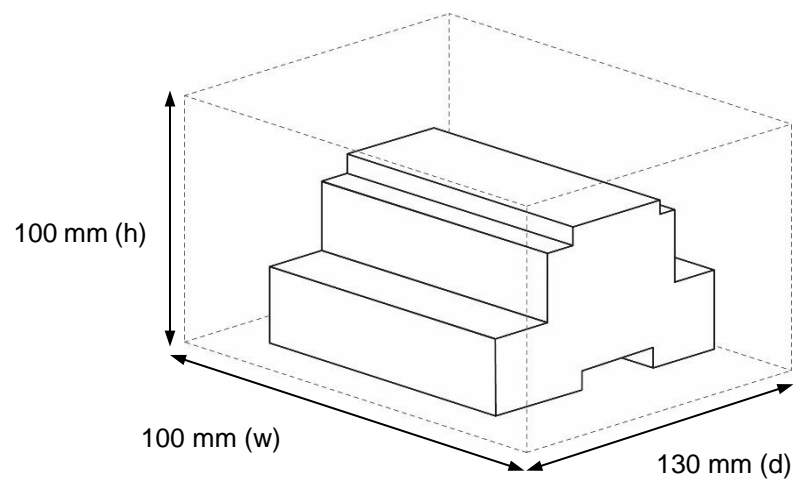

7. AC Unit Types compatibility

A list of Samsung unit model references compatible can be found in:

https://www.intesis.com/docs/compatibilities/inxxsam0xxo000_compatibility

8. Error codes for Indoor and Outdoor Units

This list contains all possible values shown in Modbus register for “Error Code” for each indoor unit and outdoor unit.

It must be taken into account that Outdoor Units are only able to reflect a single error for each indoor / outdoor unit in the system. Thus, a unit having two or more active errors from that list will only report a single error code – the one of the first error that has been detected.

Error Code	Description
101	Indoor unit communication error. Indoor unit can not receive any data from outdoor unit.
102	Communication error between indoor unit and outdoor unit. Displayed in indoor unit.
108	Error due to repeated address setting (When 2 or more devices has same address within the
110	Communication error between Hydro unit HT(Main PBA) and Control kit PBA(Detection from the Control kit)
121	Error on indoor temperature sensor of indoor unit (Short or Open)
122	Error on EVA IN sensor of indoor unit (Short or Open)
123	Error on EVA OUT sensor of indoor unit (Short or Open)
128	EVA IN temperature sensor of indoor unit is detached from EVA IN pipe
129	EVA OUT temperature sensor of indoor unit is detached from EVA OUT pipe
130	Heat exchanger in/out sensors of indoor unit are detached
135	RPM feedback error of indoor unit's cleaning fan
151	Error due to opened EEV of indoor unit (2nd detection)
152	Error due to closed EEV of indoor unit (2nd detection)
153	Error on floating switch of indoor unit (2nd detection)
154	RPM feedback error of indoor unit
161	Mixed operation mode error of indoor unit; When outdoor unit is getting ready to operate in cooling (or heating) and some of the indoor unit is trying to operate in heating (or cooling) mode
162	EEPROM error of MICOM (Physical problem of parts/circuit)
163	Indoor unit's remote controller option input is Incorrect or missing. Outdoor unit EEPROM data error
180	Simultaneous opening of cooling/heating MCU SOL V/V (1st detection)
181	Simultaneous opening of cooling/heating MCU SOL V/V (2nd detection)
185	Cross wiring error between communication and power cable of indoor unit
186	Connection error or problem on SPi
190	No temperature changes in EVA IN during pipe inspection or changes in temperature indoor unit with wrong address
191	No temperature changes in EVA OUT during pipe inspection or changes in temperature is seen in indoor unit with wrong address
198	Error due to disconnected thermal fuse of indoor unit
201	Communication error between indoor and outdoor units (installation number setting error, repeated indoor unit address, indoor unit communication cable error)
202	Communication error between indoor and outdoor units (Communication error on all indoor unit, outdoor unit communication cable error)
203	Communication error between main and sub outdoor units
205	Communication error on all PBA within the outdoor unit C-Box, communication cable error
206	E206-C001: HUB PBA communication error / E206-C002: FAN PBA communication error E206-C003: INV1 PBA communication error / E206-C004: INV2 PBA communication error
211	When single indoor unit uses 2 MCU ports that are not in series.
212	If the rotary switch (on the MCU) for address setting of the indoor unit has 3 or more of the same address

213	When total number of indoor units assigned to MCU is same as actual number of installed indoor units but there is indoor unit that is not installed even though it is assigned on MCU
214	When number of MCU is not set correctly on the outdoor unit or when two or more MCU was installed some of them have the same address
215	When two different MCU's have same address value on the rotary switch
216	When indoor unit is not installed to a MCU port but the switch on the port is set to On.
217	When indoor unit is connected to a MCU port but indoor unit is assigned to a MCU and the switch on the port is set to Off
218	When there's at least one or more actual number of indoor unit connection compared to number of indoor units assigned to MCU
219	Error on temperature sensor located on MCU intercooler inlet (Short or Open)
220	Error on temperature sensor located on MCU intercooler outlet (Short or Open)
221	Error on outdoor temperature sensor of outdoor unit (Short or open)
231	Error on COND OUT temperature sensor of main outdoor unit (Short or Open)
241	COND OUT sensor is detached
251	Error on discharge temperature sensor of compressor 1 (Short or Open)
257	Error on discharge temperature sensor of compressor 2 (Short or Open)
262	Discharge temperature sensor of compressor 1 is detached from the sensor holder on the pipe
263	Discharge temperature sensor of compressor 2 is detached from the sensor holder on the pipe
266	Top sensor of compressor 1 is detached
267	Top sensor of compressor 2 is detached
269	Suction temperature sensor is detached from the sensor holder on the pipe
276	Error on top sensor of compressor 1 (Short or Open)
277	Error on top sensor of compressor 2 (Short or Open)
291	Refrigerant leakage or error on high pressure sensor (Short or Open)
296	Refrigerant leakage or error on low pressure sensor (Short or Open)
308	Error on suction temperature sensor (Short or Open)
311	Error on temperature sensor of double layer pipe/liquid pipe(sub heat exchanger) (Short or Open)
321	Error on EVI (ESC) IN temperature sensor (Short or Open)
322	Error on EVI (ESC) OUT temperature sensor (Short or Open)
323	Error on suction sensor 2 (Short or Open)
346	Error due to operation failure of Fan2
347	Motor wire of Fan2 is not connected
348	Lock error on Fan2 of outdoor unit
353	Error due to overheated motor of outdoor unit's Fan2
355	Error due to overheated IPM of Fan2
361	Error due to operation failure of inverter compressor 2
364	Error due to over-current of inverter compressor 2
365	V-limit error of inverter compressor 2
366	Error due to over voltage /low voltage of inverter PBA2
367	Error due to unconnected wire of compressor 2
368	Output current sensor error of inverter PBA2
369	DC voltage sensor error of inverter PBA2
374	Heat sink temperature sensor error of inverter PBA2
378	Error due to overcurrent of Fan2
385	Error due to input current of inverter 2
386	Over-voltage/low-voltage error of Fan2
387	Hall IC connection error of Fan2
389	V-limit error on Fan2 of compressor
393	Output current sensor error of Fan2

396	DC voltage sensor error of Fan2
399	Heat sink temperature sensor error of Fan2
400	Error due to overheat caused by contact failure on IPM of Inverter PBA2
407	Compressor operation stop due to high pressure protection control
410	Compressor operation stop due to low pressure protection control or refrigerant leakage
416	Compressor operation stop due to discharge temperature protection control
425	Phase reversal or phase failure (3Ø outdoor unit wiring, R-S-T-N), connection error on 3 phase input
428	Compressor operation stop due abnormal compression ratio
438	EVI (ESC) EEV leakage or internal leakage of intercooler or incorrect connector insertion of EVI (ESC) EEV
439	Error due to refrigerant leakage
440	Heating mode restriction due to high air temperature
441	Cooling mode restriction due to low air temperature
442	Refrigerant charging restriction in heating mode when air temperature is over 15 °C
443	Operation prohibited due to the pressure drop
445	CCH is deatched
446	Error due to operation failure of Fan1
447	Motor wire of Fan1 is not connected
448	Lock error on Fan1
452	Error due to ZPC detection circuit problem or power failure
453	Error due to overheated motor of outdoor unit's Fan1
455	Error due to overheated IPM of Fan1
461	Error due to operation failure of inverter compressor 1
462	Compressor stop due to full current control or error due to low current on CT2
464	Error due to over-current of inverter compressor 1
465	V-limit error of inverter compressor 1
466	Error due to over voltage /low voltage of inveter PBA1
467	Error due to unconnected wire of compressor 1
468	Output current sensor error of inverter PBA1
469	DC voltage sensor error of inver PBA1
474	Heat sink temperature sensor error of inverter PBA1
478	Error due to overcurrent of Fan1
485	Error due to input current of inverter 1
486	Error due to over voltage/low voltage of Fan
487	Hall IC error of Fan1
489	V-limit error on Fan1 of compressor
493	Output current sensor error of Fan1
496	DC voltage sensor error of Fan1
499	Heat sink temperature sensor error of Fan1
500	Error due to overheat caused by contact failure on IPM of Inverter PBA1
503	Error due to alert the user to check if the service valve is closed
504	Error due to self diagnosis of compressor operation
505	Error due to self diagnosis of high pressure sensor
506	Error due to self diagnosis of low pressure sensor
560	Outdoor unit's option switch setting error (when iinappropriate option switch is on)
563	Error due to module installation of indoor unit with old version (Micom version needs to be checked)
573	Error due to using single type outdoor unit in a module installation
601	Communication error between remote controller and the DVM Hydro unit / Hydro unit HT
602	Communication error between master and slave remote controller