

SOT-886 to DIP-6 SMT Adapter (0.5 mm pitch, 1.35 x 1.0 mm body)

REF.	DIMENSIONS					
	mm			inches		
	MIN.	TYP.	MAX.	MIN.	TYP.	MAX.
A		0.25				
B		0.425				
C		0.30				
D		0.20				
E		0.50				
F					0.600	
G					0.100	
H					0.025	

Top View (SMT Footprint)

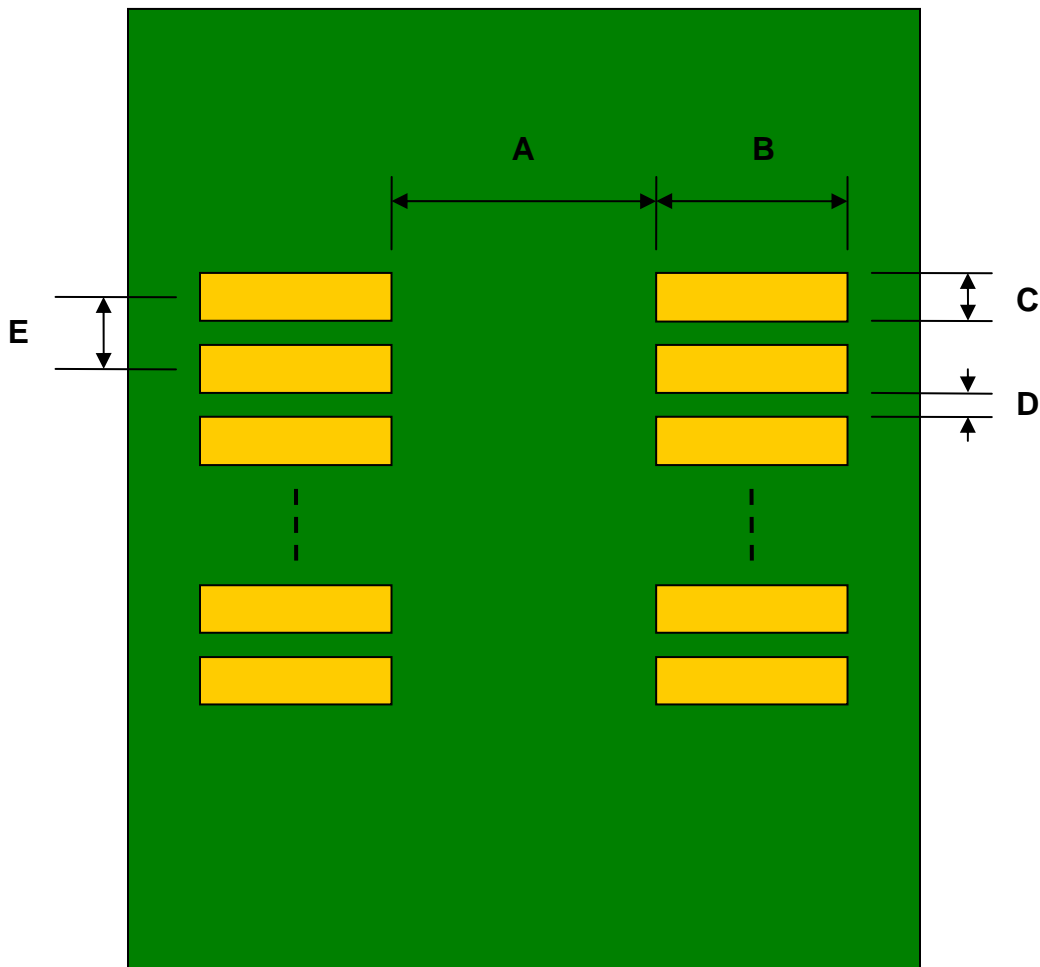

(Representative drawing only - not to scale)

Bottom View (DIP Pins)

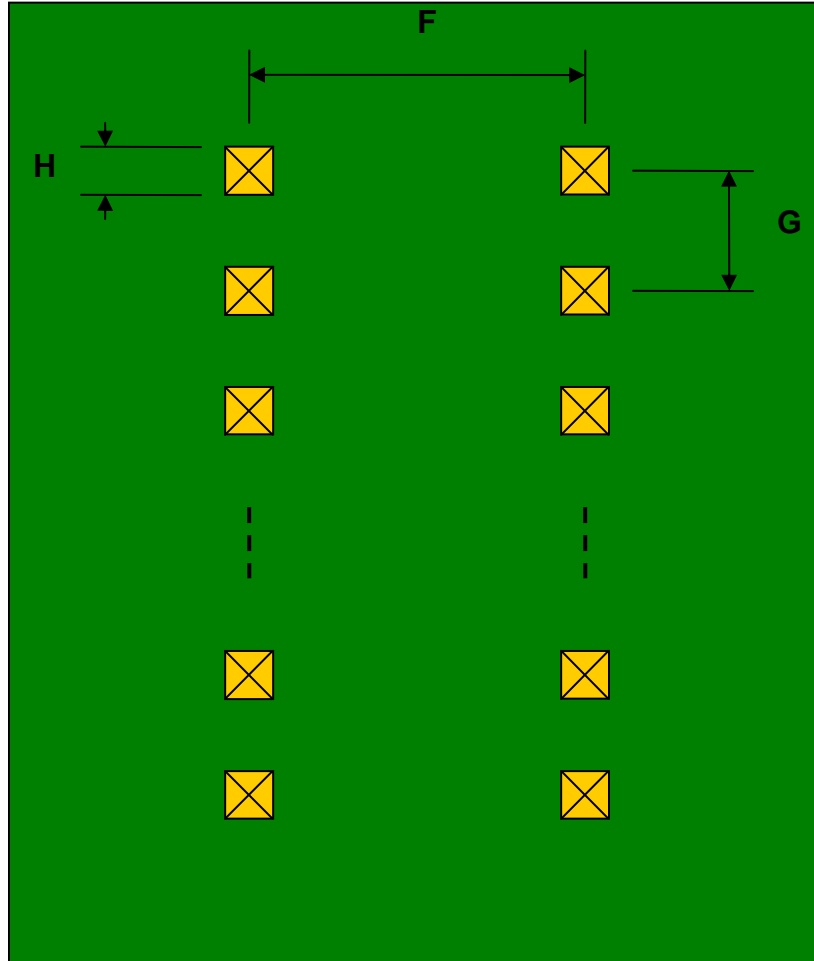

(Representative drawing only - not to scale)

Side View (DIP Pins)

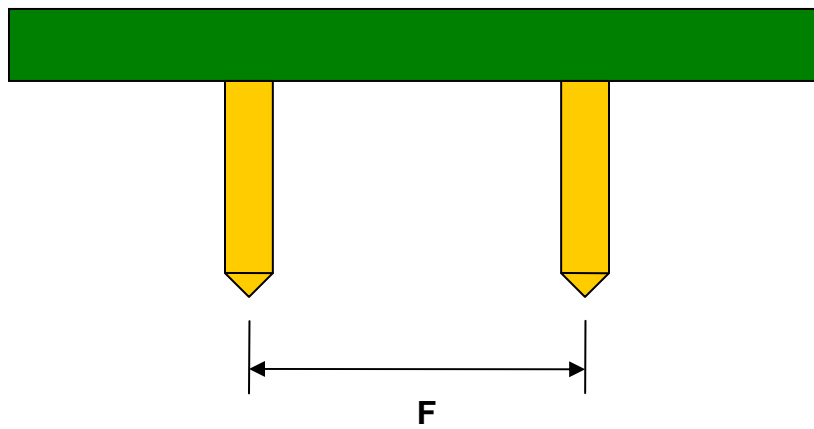

(Representative drawing only - not to scale)