

# IS31LT3177/78

## 10-TO-200MA CONSTANT-CURRENT LED DRIVER

September 2020

### GENERAL DESCRIPTION

The IS31LT3177 and IS31LT3178 are adjustable linear current devices with excellent temperature stability. A single resistor is all that is required to set the operating current from 10mA to 200mA. The devices can operate from an input voltage from 2.9V to 40V with a minimal voltage headroom of 1.0V (Typ.) at 150mA. Designed with a low dropout voltage; the device can drive LED strings close to the supply voltage without switch capacitors or inductors.

The IS31LT3177/78 simplifies designs by providing a stable current without the additional requirement of inductors, FETs or diodes. The complete constant current driver requires only a current set resistor and a small PCB area making designs both efficient and cost effective.

The EN Pin of the IS31LT3177 can be tied to  $V_{BAT}$  or PSM (Power Supply Modulation) signal for high side dimming. The EN Pin of the IS31LT3178 can function as the PWM signal input used for MCU PWM dimming.

As a current sink it is ideal for LED lighting applications or current limiter for power supplies.

The device is provided in a lead (Pb) free, SOT23-6 and SOP-8-EP packages.

### FEATURES

- Low-side current sink
  - Adjustable from 10mA to 150mA (SOT23-6)/200mA (SOP-8-EP) with external resistor selection
- Wide input voltage range from
  - 2.9V to 40V (IS31LT3178)
  - 5V to 40V (IS31LT3177)with a low dropout of typical 1.0V at 150mA
- Up to 1kHz PWM input (IS31LT3178 only)
- $\pm 5\%$  current accuracy
- Protection features:
  - 0.6%/K current roll off at high temp over 145°C for thermal protection
  - Output current limit
  - Thermal shutdown
- Up to 0.77W (SOT23-6)/2.32W (SOP-8-EP) power dissipation in a small package
- RoHS compliant (Pb-free) package

### APPLICATIONS

- General lighting
- Architectural LED lighting
- Channel letters for advertising, LED strips for decorative lighting
- Retail lighting in fridge, freezer case and vending machines
- Emergency lighting (e.g. steps lighting, exit way sign etc.)

# IS31LT3177/78

## TYPICAL APPLICATION CIRCUIT

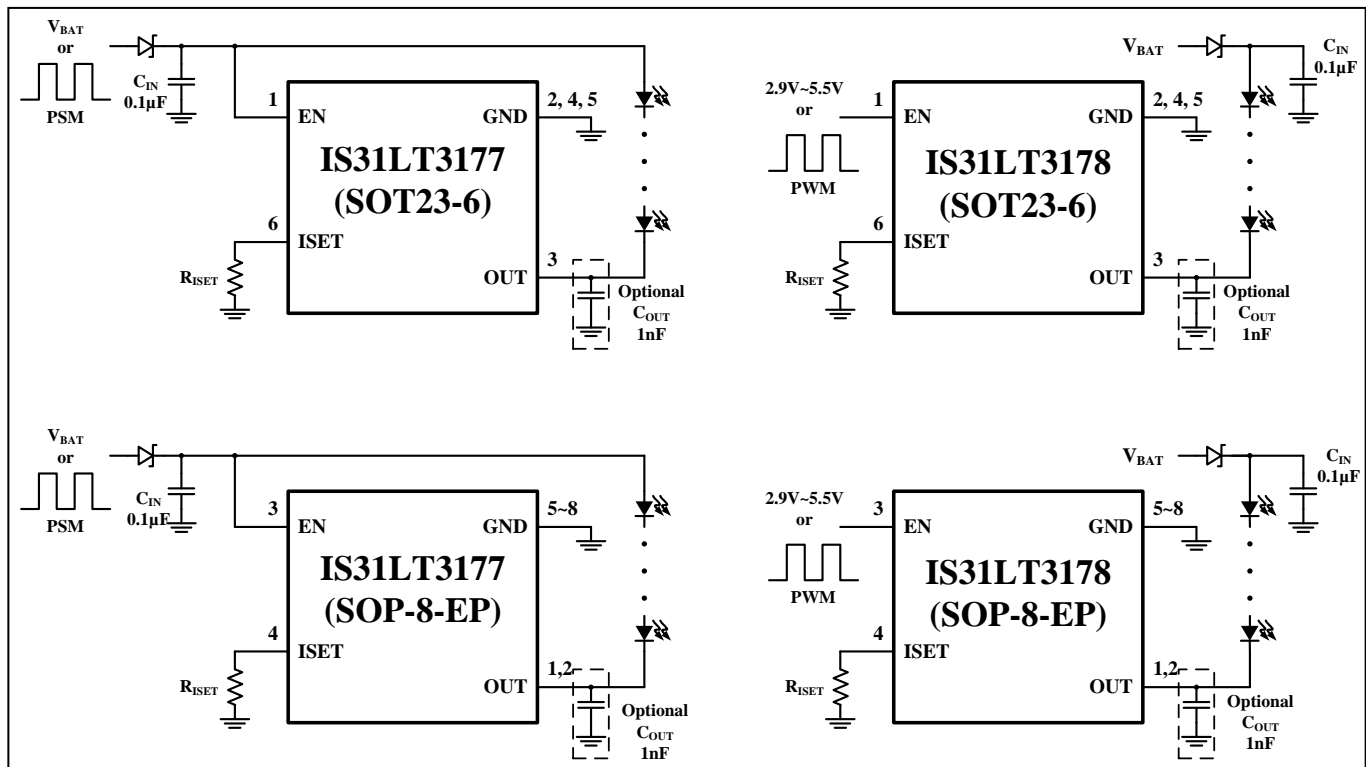


Figure 1 Typical Application Circuit

**Note 1:** All GND pins must be connected to ground.

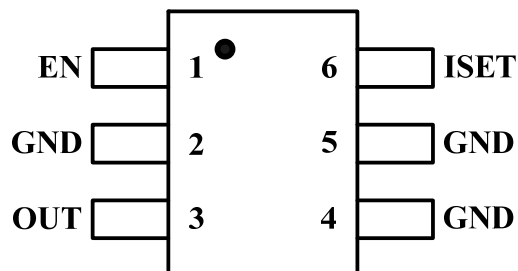
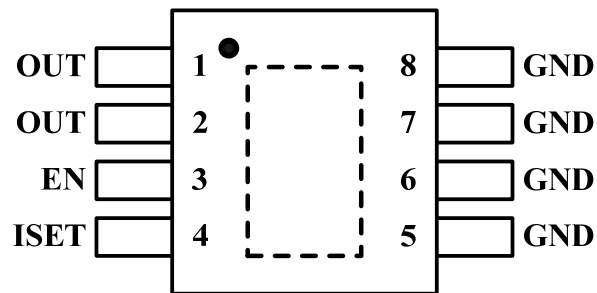
**Note 2:**  $C_{IN}$  must be placed close to IC. If no PSM dimming requirement, please use larger value for  $C_{IN}$ .

**Note 3:**  $C_{OUT}$  is optional. When the LED connection wire is long, the  $C_{OUT}$  should be placed close to OUT pin to avoid EMI interference.

**Note 4:**  $R_{ISET}$  MUST be placed close to ISET and GND pins to improve the Electro-Magnetic Susceptibility (EMS) performance.

# IS31LT3177/78

## PIN CONFIGURATION

Package	Pin Configuration (Top View)
SOT23-6	
SOP-8-EP	

## PIN DESCRIPTION

No.		Pin	Description
SOT23-6	SOP-8-EP		
3	1, 2	OUT	Current sink.
1	3	EN	Enable pin (PWM input IS31LT3178 only).
6	4	ISET	Output current setting pin. Connect a resistor between this pin and GND to set the maximum output current.
2, 4, 5	5~8	GND	Ground pin. All GND pins must be connected to supply ground.
-		Thermal Pad	Connect to GND.

# IS31LT3177/78

## ORDERING INFORMATION

Industrial Range: -40°C to +125°C

Order Part No.	Package	QTY/Reel
IS31LT3177-STLS4-TR IS31LT3178-STLS4-TR	SOT23-6, Lead-free	3000
IS31LT3177-GRLS4-TR IS31LT3178-GRLS4-TR	SOP-8-EP, Lead-free	2500

Copyright © 2020 Lumissil Microsystems. All rights reserved. Lumissil Microsystems reserves the right to make changes to this specification and its products at any time without notice. Lumissil Microsystems assumes no liability arising out of the application or use of any information, products or services described herein. Customers are advised to obtain the latest version of this device specification before relying on any published information and before placing orders for products.

Lumissil Microsystems does not recommend the use of any of its products in life support applications where the failure or malfunction of the product can reasonably be expected to cause failure of the life support system or to significantly affect its safety or effectiveness. Products are not authorized for use in such applications unless Lumissil Microsystems receives written assurance to its satisfaction, that:

- a.) the risk of injury or damage has been minimized;
- b.) the user assume all such risks; and
- c.) potential liability of Lumissil Microsystems is adequately protected under the circumstances

# IS31LT3177/78

## ABSOLUTE MAXIMUM RATINGS (Note 5)

Maximum enable voltage, $V_{EN(MAX)}$ only for IS31LT3177	44V
$V_{EN(MAX)}$ only for IS31LT3178	6.0V
Maximum output current, $I_{OUT(MAX)}$	250mA
Maximum output voltage, $V_{OUT(MAX)}$	44V
Reverse voltage between all terminals, $V_R$	0.5V
Power dissipation, $P_{D(MAX)}$ (Note 6)	0.77W (SOT23-6)
	2.32W (SOP-8-EP)
Maximum junction temperature, $T_{JMAX}$	+150°C
Storage temperature range, $T_{STG}$	-65°C ~ +150°C
Operating temperature range, $T_A=T_J$	-40°C ~ +125°C
Package thermal resistance, junction to ambient (4 layer standard test PCB based on JESD 51-2A), $\theta_{JA}$	130°C/W (SOT23-6)
	43.1°C/W (SOP-8-EP)
Package thermal resistance, junction to thermal PAD (4 layer standard test PCB based on JESD 51-8), $\theta_{JP}$	1.41°C/W (SOP-8-EP)
ESD (HBM)	±2kV
ESD (CDM)	±750V

**Note 5:** Stresses beyond those listed under “Absolute Maximum Ratings” may cause permanent damage to the device. These are stress ratings only and functional operation of the device at these or any other condition beyond those indicated in the operational sections of the specifications is not implied. Exposure to absolute maximum rating conditions for extended periods may affect device reliability.

**Note 6:** Detail information please refer to package thermal de-rating curve on Page 16.

## ELECTRICAL CHARACTERISTICS

“●” This symbol in the table means these parameters are for IS31LT3177.

“○” This symbol in the table means these parameters are for IS31LT3178.

Test condition is  $T_A = T_J = 25^\circ\text{C}$ , unless otherwise specified. (Note 7)

Symbol	Parameter	Condition	Min.	Typ.	Max.	Unit	
$V_{BD\_OUT}$	OUT pin breakdown voltage	$V_{EN} = 0V$	40			V	
$V_{ISET}$	Current setting reference voltage			1.0		V	
$I_{EN}$	Enable current	$V_{EN} = 12V, R_{ISET} = 16k\Omega$	●	0.5	1.00	mA	
		$V_{EN} = 3.3V, R_{ISET} = 16k\Omega$	○	0.5	1.00		
$I_{OUT}$	Output current	$V_{OUT} = 0.8V, V_{EN} = 12V, R_{ISET} = 160k\Omega$	●	10		mA	
		$V_{OUT} = 0.8V, V_{EN} = 3.3V, R_{ISET} = 160k\Omega$	○	10			
		$V_{OUT} > 1.0V, V_{EN} = 12V, R_{ISET} = 16k\Omega$	●	95	100	105	mA
		$V_{OUT} > 1.0V, V_{EN} = 3.3V, R_{ISET} = 16k\Omega$	○	95	100	105	
	Output current	$V_{OUT} > 1.5V, V_{EN} = 12V, R_{ISET} = 10.6k\Omega, \text{SOT23-6}$	●	142.5	150	157.5	mA
		$V_{OUT} > 1.5V, V_{EN} = 3.3V, R_{ISET} = 10.6k\Omega, \text{SOT23-6}$	○	142.5	150	157.5	
		$V_{OUT} > 1.5V, V_{EN} = 12V, R_{ISET} = 8k\Omega, \text{SOP-8-EP}$	●	190	200	210	mA
		$V_{OUT} > 1.5V, V_{EN} = 3.3V, R_{ISET} = 8k\Omega, \text{SOP-8-EP}$	○	190	200	210	

# IS31LT3177/78

## DC CHARACTERISTICS WITH STABILIZED LED LOAD

“●” This symbol in the table means these parameters are for IS31LT3177.

“○” This symbol in the table means these parameters are for IS31LT3178.

Test condition is  $T_A = T_J = 25^\circ\text{C}$ , unless otherwise specified. (Note 7)

Symbol	Parameter	Condition	Min.	Typ.	Max.	Unit
$I_{OUT\_LIMIT}$	Output current limit	$R_{ISET} = \text{GND}, V_{EN} = 12\text{V}$	●	295		mA
		$R_{ISET} = \text{GND}, V_{EN} = 3.3\text{V}$	○	295		
$V_{UVLO}$	EN pin undervoltage lockout threshold	$V_{EN}$ rising	●	3.1	3.6	V
			○	1.9	2.4	
		$V_{EN}$ falling	●	2.4	2.9	
			○	1.2	1.7	
$V_{EN}$	Sufficient supply voltage on EN pin	$10\text{mA} \leq I_{OUT} \leq 200\text{mA}, V_{OUT} = 2\text{V}$	●	5	40	V
		$10\text{mA} \leq I_{OUT} \leq 150\text{mA}, V_{OUT} = 2\text{V}, \text{SOT23-6}$	○	2.9	5.5	
		$150\text{mA} < I_{OUT} \leq 200\text{mA}, V_{OUT} = 2\text{V}, \text{SOP-8-EP}$	○	3.1	5.5	
$V_{HR}$	Minimum required headroom voltage on OUT pin	$I_{OUT} = 150\text{mA}, \text{SOT23-6}$	●	1.2		V
		$I_{OUT} = 150\text{mA}, \text{SOT23-6}$	○	1.2		
		$I_{OUT} = 200\text{mA}, \text{SOP-8-EP}$	●	1.5		
		$I_{OUT} = 200\text{mA}, \text{SOP-8-EP}$	○	1.5		
$t_{ON}$	EN pin enabling time	$V_{OUT} > 1.5\text{V}, V_{EN} = 5\text{V}, R_{ISET} = 16\text{k}\Omega$	●		10	$\mu\text{s}$
		$V_{OUT} > 1.5\text{V}, V_{EN} = 3.3\text{V}, R_{ISET} = 16\text{k}\Omega$	○		10	
$T_{RO}$	Thermal roll off threshold	Current decreasing slope rate: $-0.6\%/^\circ\text{C}$ (Note 8)		145		$^\circ\text{C}$
$T_{SD}$	Thermal shutdown threshold	Temperature rising (Note 8)		170		$^\circ\text{C}$
$T_{SD\_HY}$	Thermal shutdown hysteresis	Temperature falling (Note 8)		30		$^\circ\text{C}$

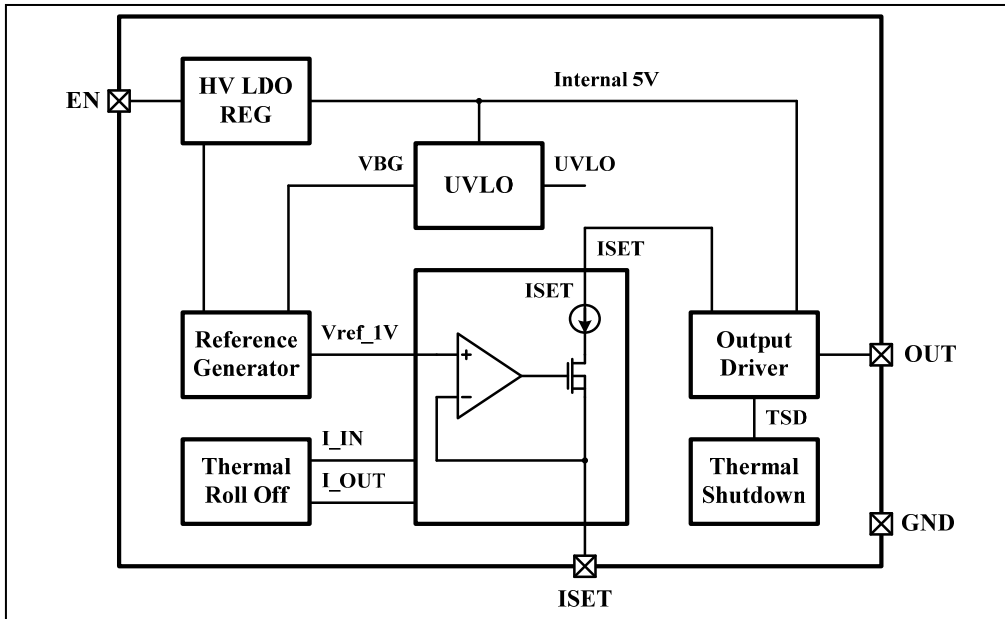
**Note 7:** Production testing of the device is performed at  $25^\circ\text{C}$ . Functional operation of the device and parameters specified over  $-40^\circ\text{C}$  to  $+125^\circ\text{C}$  temperature range, are guaranteed by design and characterization.

**Note 8:** Guaranteed by design.

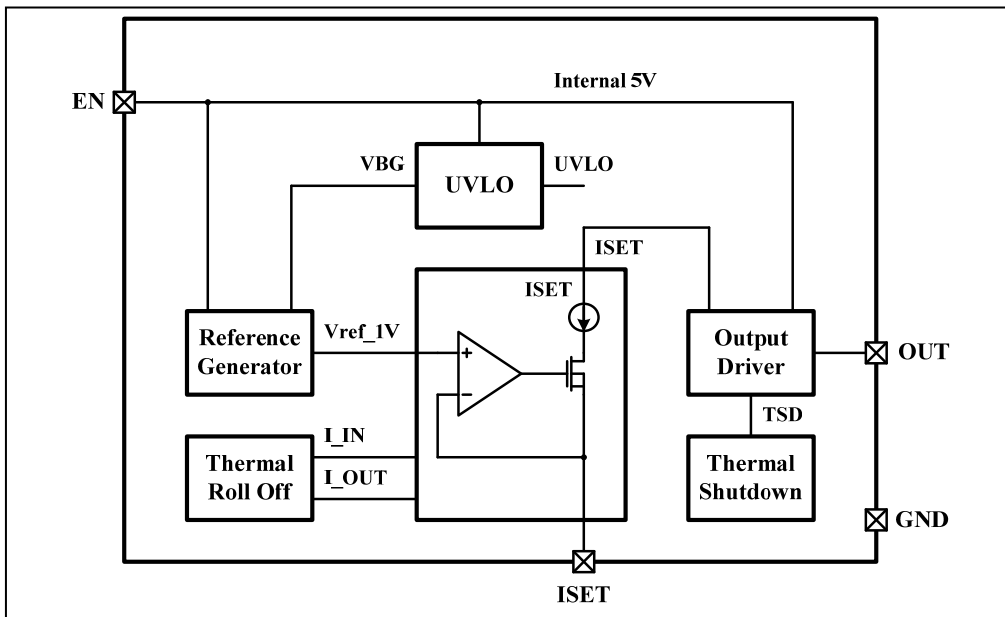
# IS31LT3177/78

## FUNCTIONAL BLOCK DIAGRAM

IS31LT3177



IS31LT3178



# IS31LT3177/78

## TYPICAL PERFORMANCE CHARACTERISTICS

### IS31LT3177

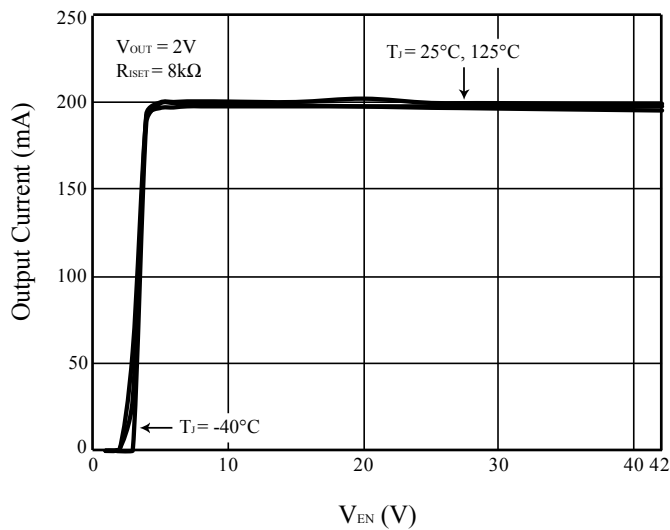


Figure 2 Output Current vs.  $V_{EN}$

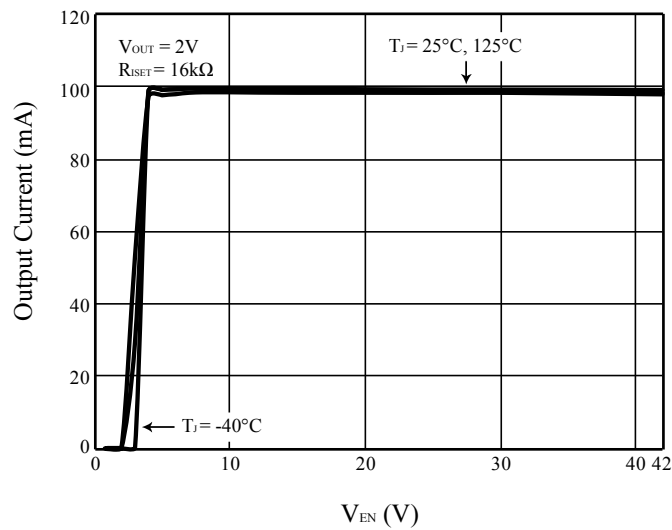


Figure 3 Output Current vs.  $V_{EN}$

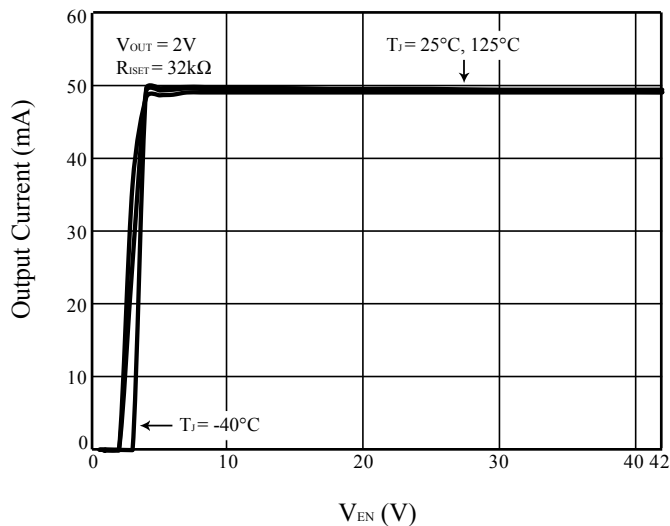


Figure 4 Output Current vs.  $V_{EN}$

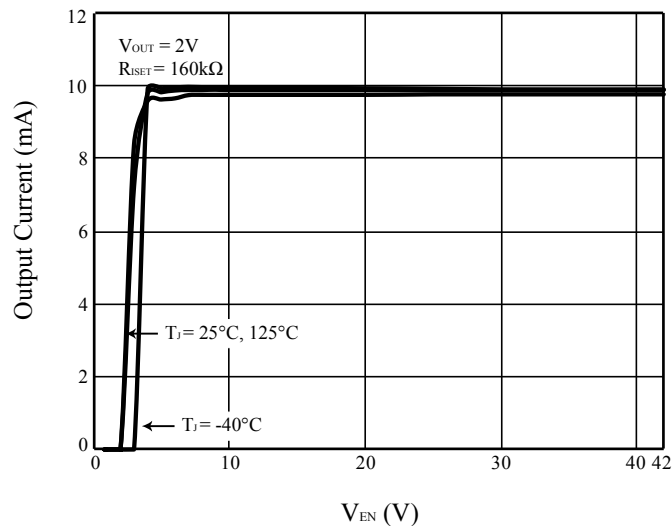


Figure 5 Output Current vs.  $V_{EN}$

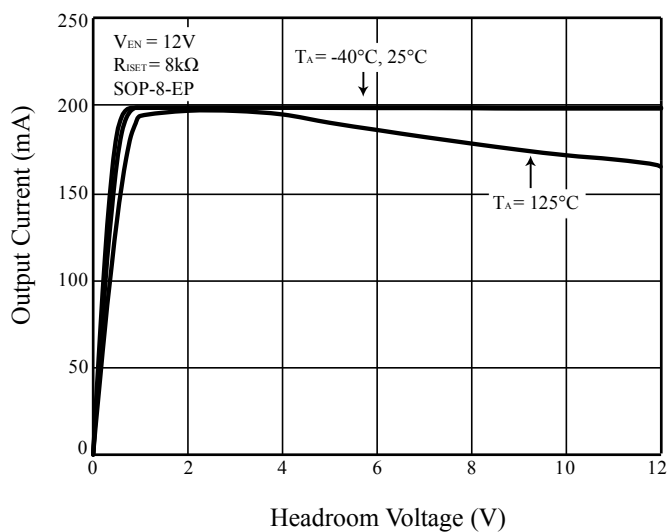


Figure 6 Output Current vs. Headroom Voltage

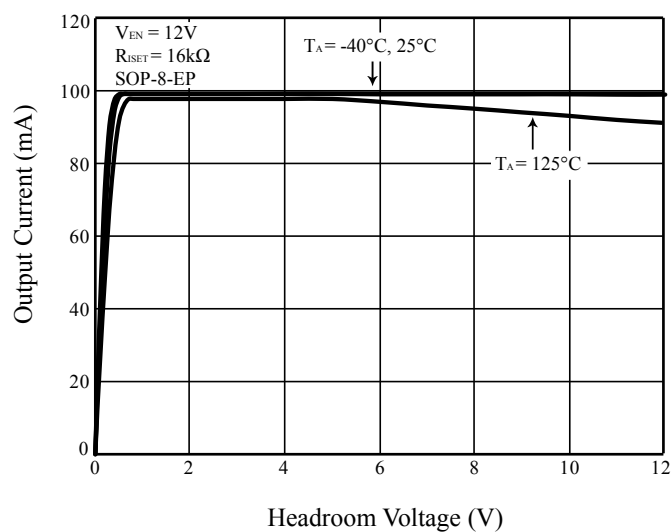
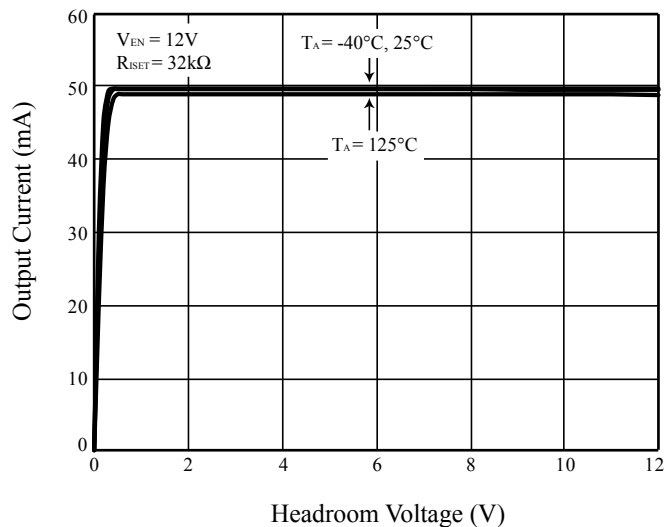


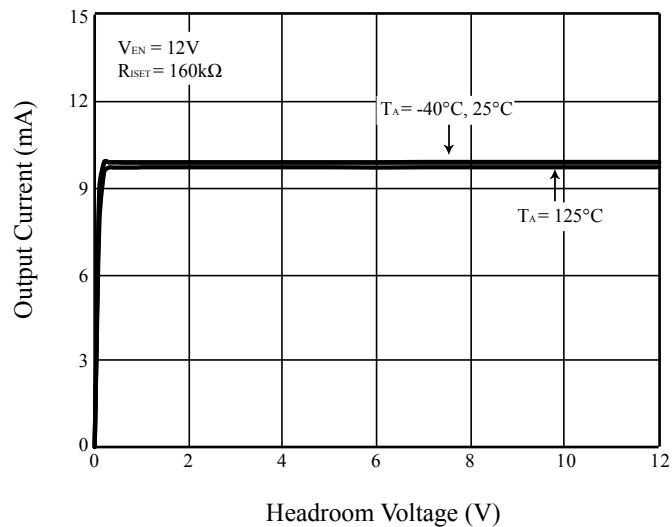
Figure 7 Output Current vs. Headroom Voltage



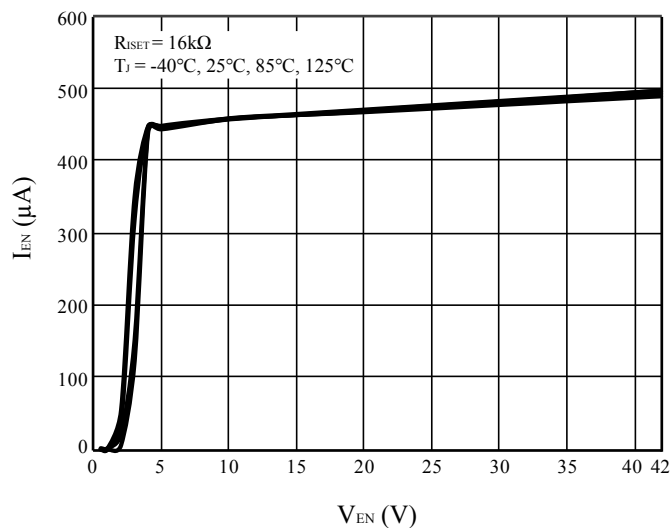
# IS31LT3177/78



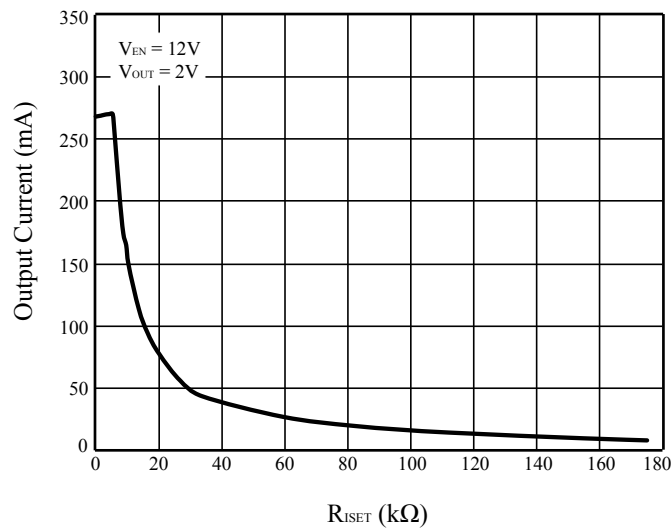
**Figure 8** Output Current vs. Headroom Voltage



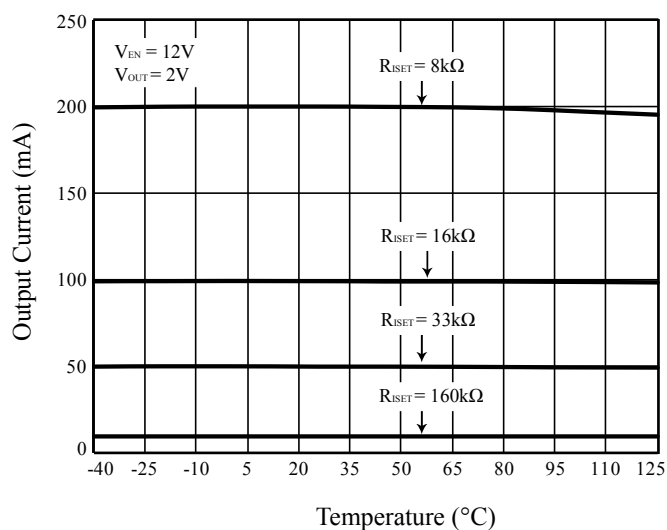
**Figure 9** Output Current vs. Headroom Voltage



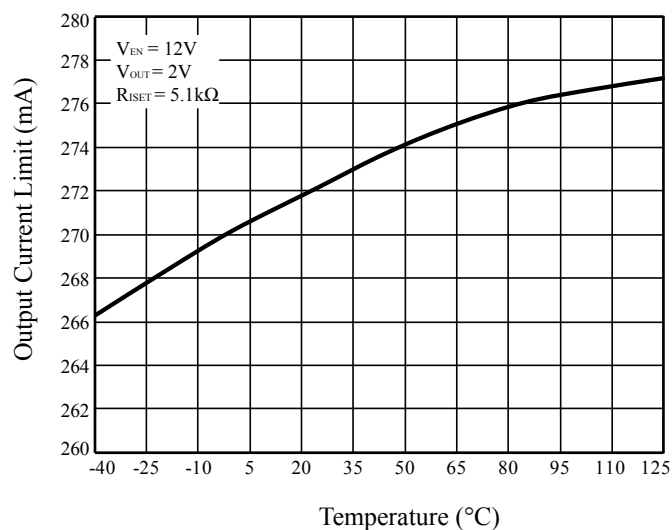
**Figure 10**  $I_{EN}$  vs.  $V_{EN}$



**Figure 11** Output Current vs.  $R_{ISET}$



**Figure 12** Output Current vs. Temperature



**Figure 13** Output Current Limit vs. Temperature

# IS31LT3177/78

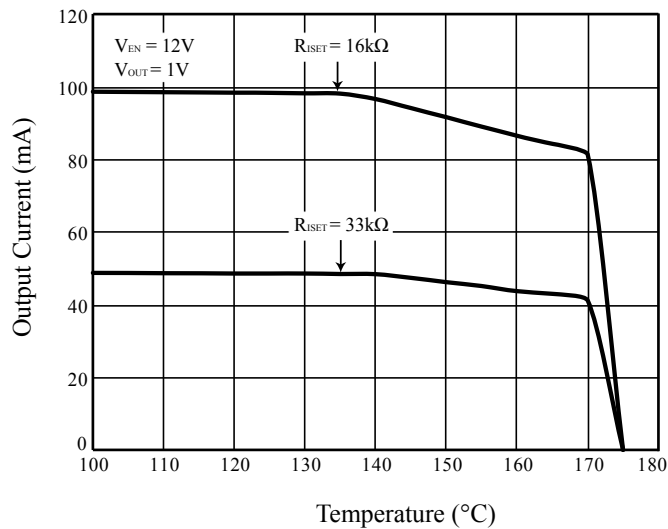


Figure 14 Output Current vs. Temperature (Thermal Roll Off)

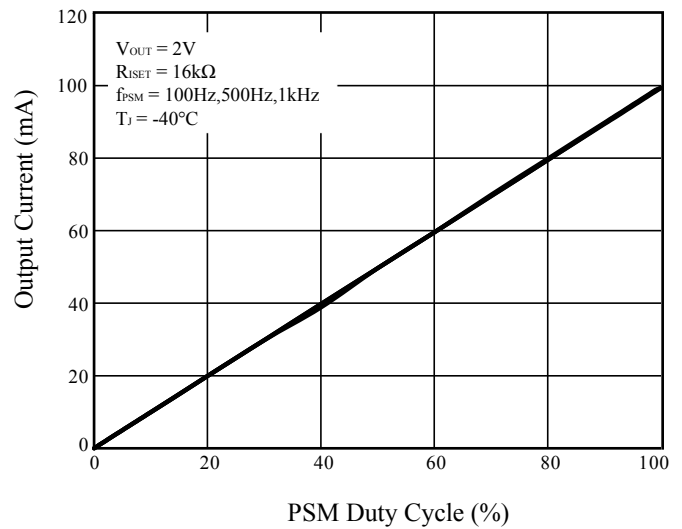


Figure 15 Output Current vs. PSM Duty Cycle

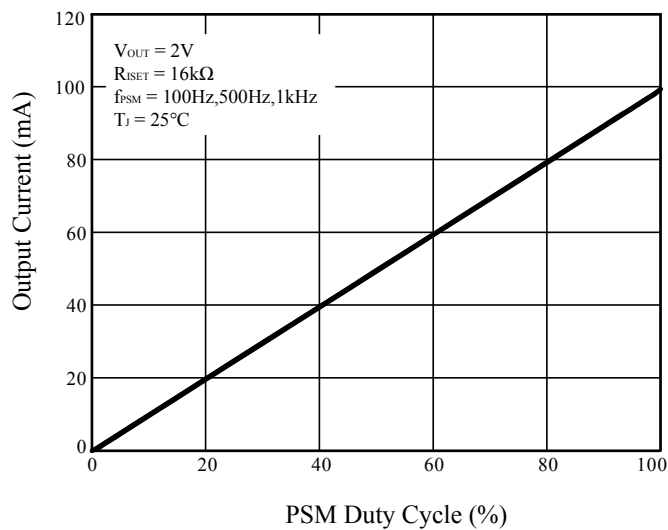


Figure 16 Output Current vs. PSM Duty Cycle

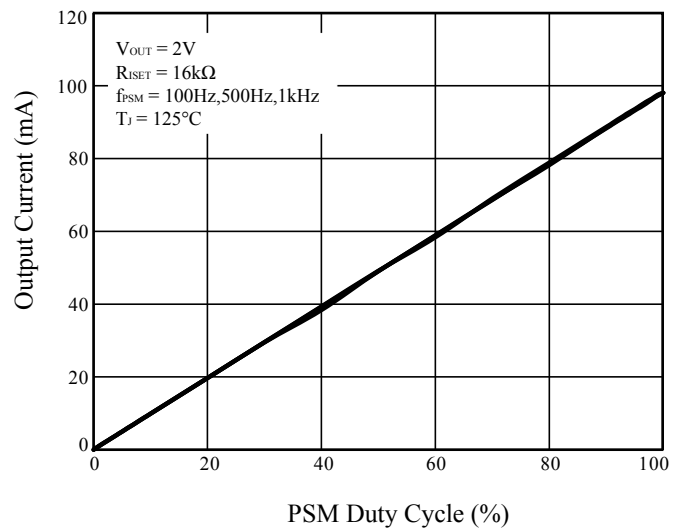


Figure 17 Output Current vs. PSM Duty Cycle

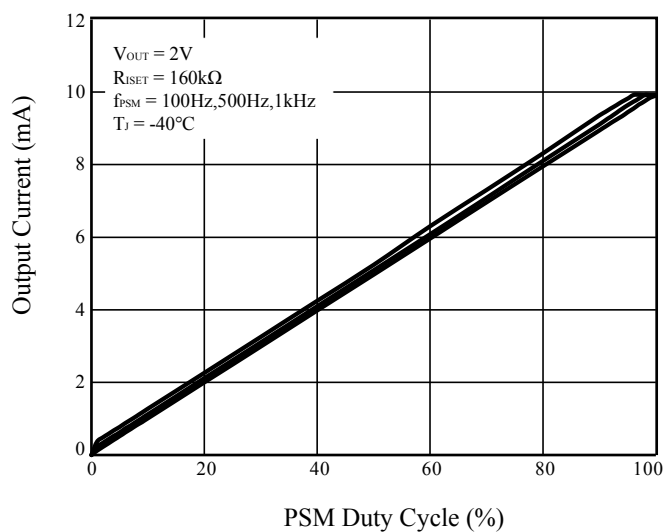


Figure 18 Output Current vs. PSM Duty Cycle

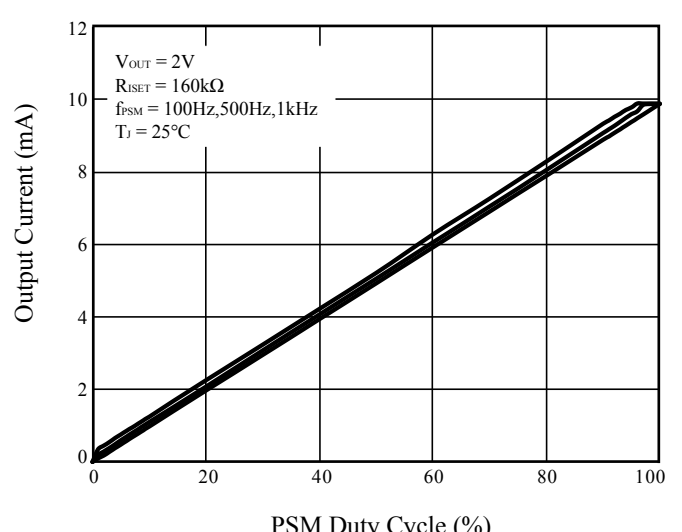
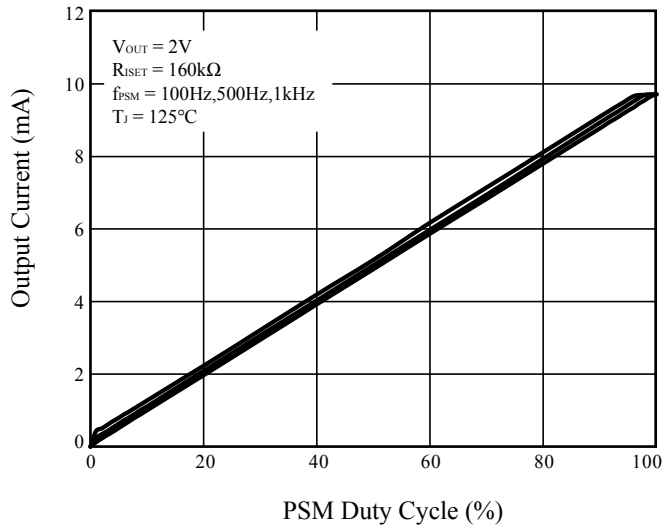
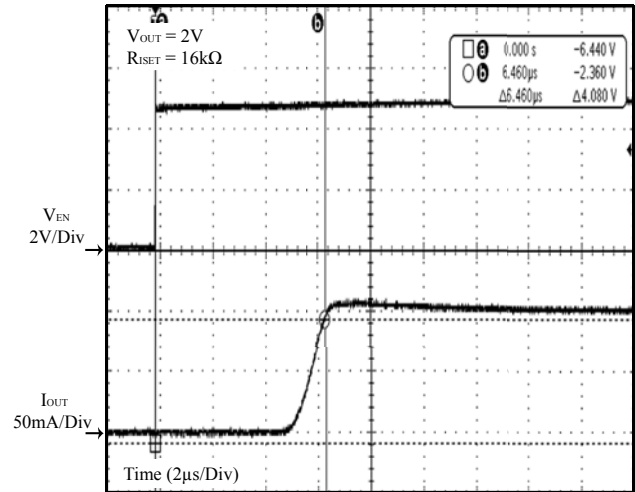


Figure 19 Output Current vs. PSM Duty Cycle

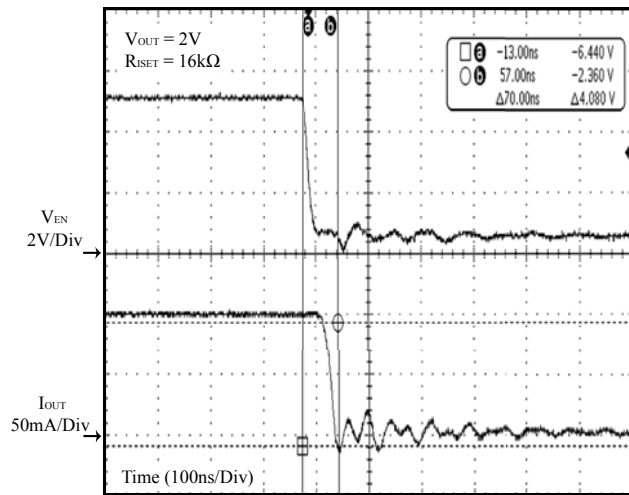
# IS31LT3177/78



**Figure 20** Output Current vs. PSM Duty Cycle



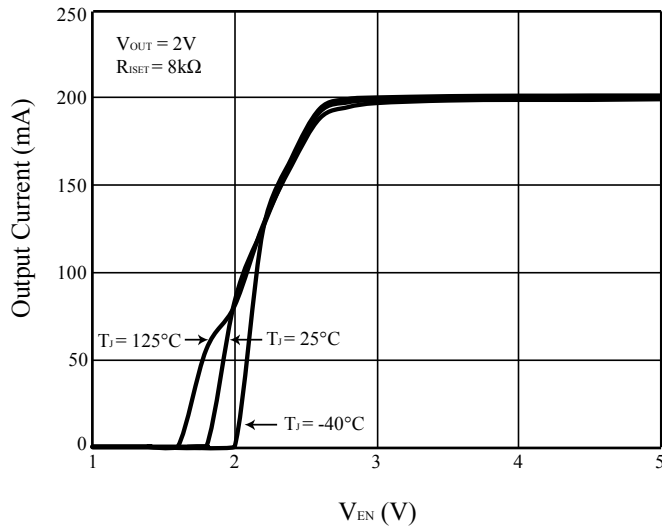
**Figure 21** Start Up



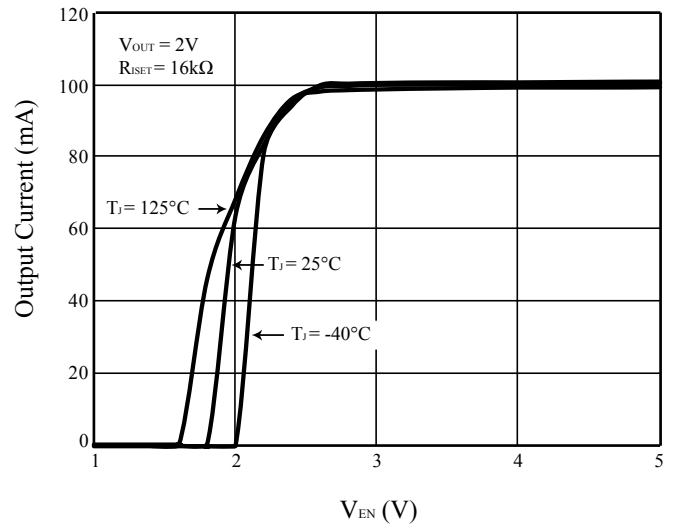
**Figure 22** Shut Down

# IS31LT3177/78

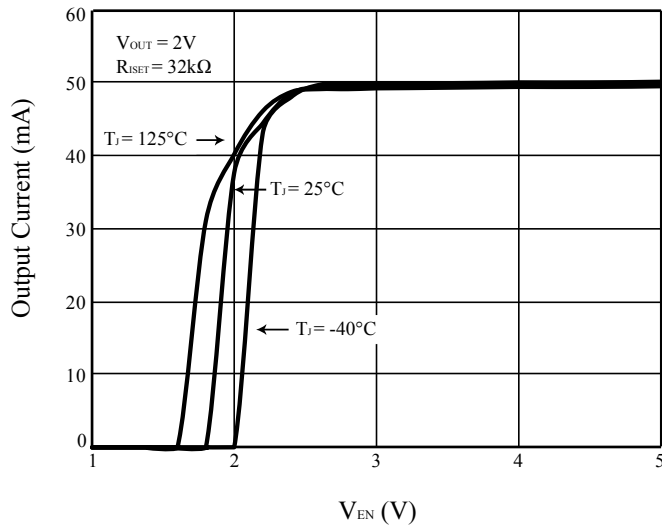
## IS31LT3178



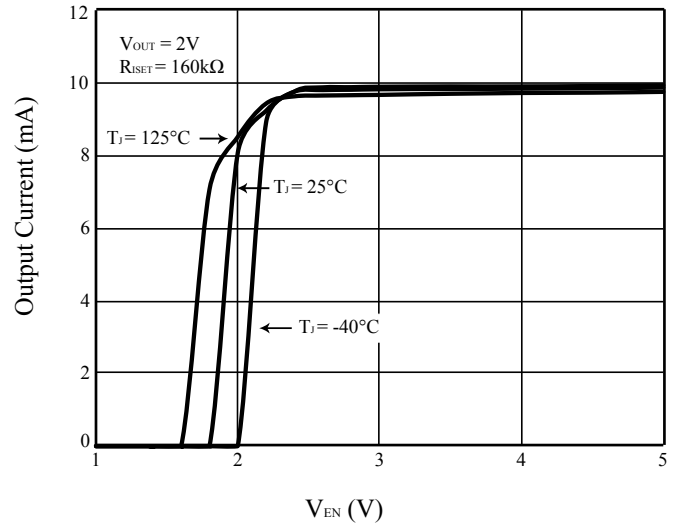
**Figure 23** Output Current vs.  $V_{EN}$



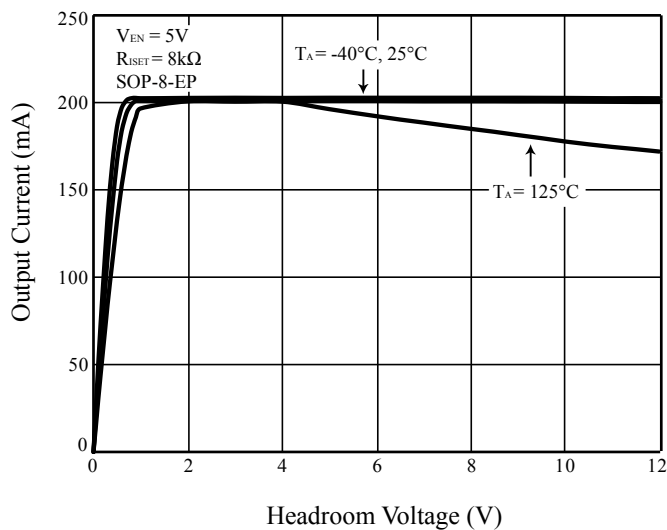
**Figure 24** Output Current vs.  $V_{EN}$



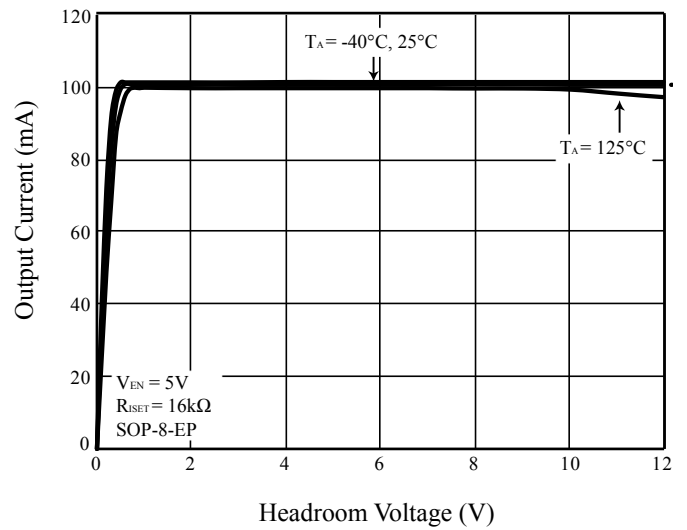
**Figure 25** Output Current vs.  $V_{EN}$



**Figure 26** Output Current vs.  $V_{EN}$

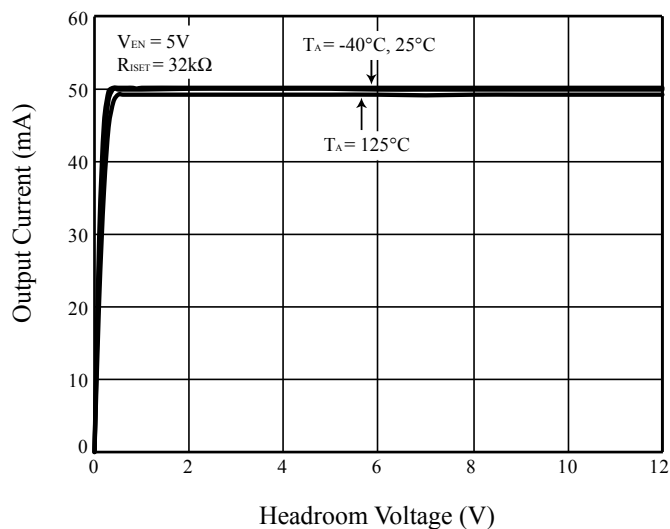


**Figure 27** Output Current vs. Headroom Voltage

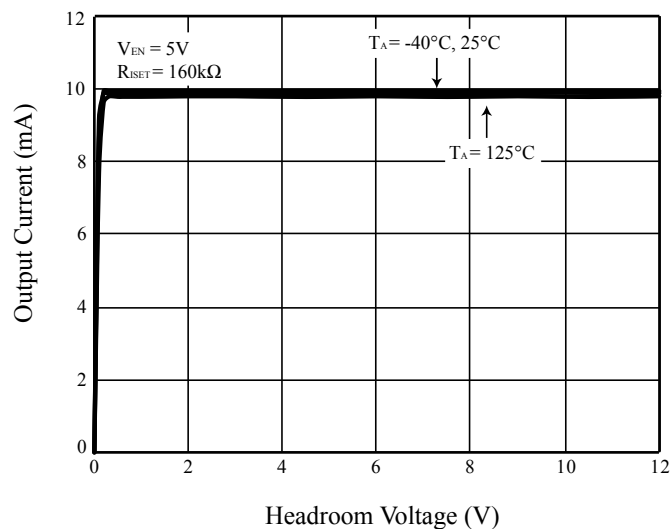


**Figure 28** Output Current vs. Headroom Voltage

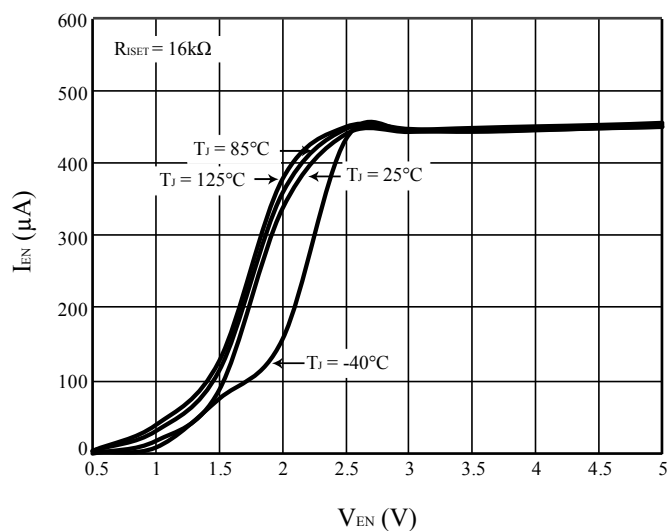
# IS31LT3177/78



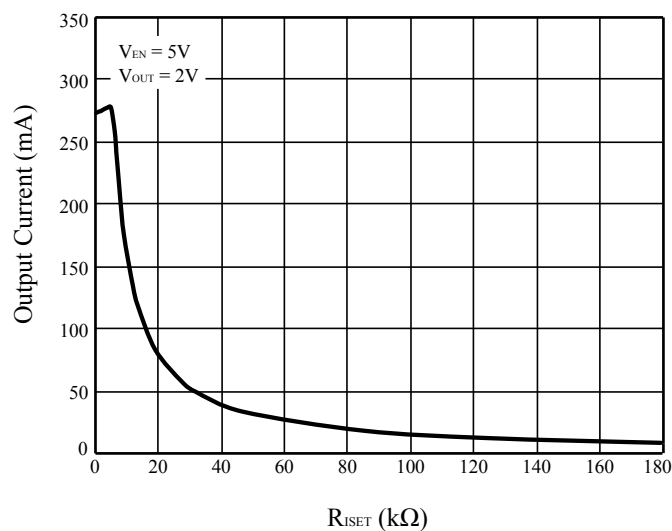
**Figure 29** Output Current vs. Headroom Voltage



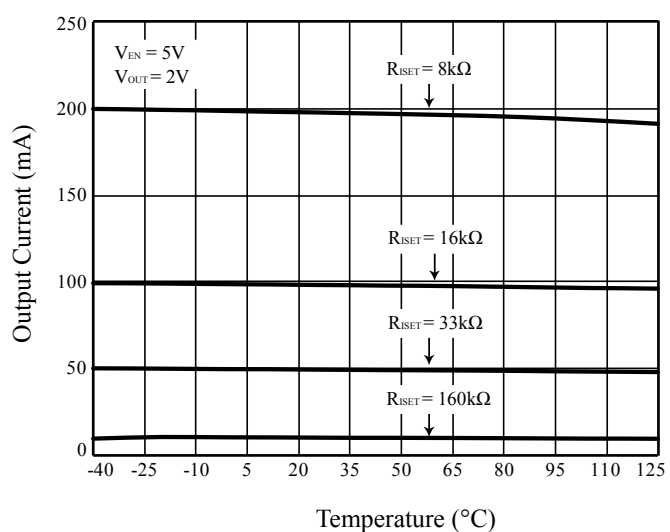
**Figure 30** Output Current vs. Headroom Voltage



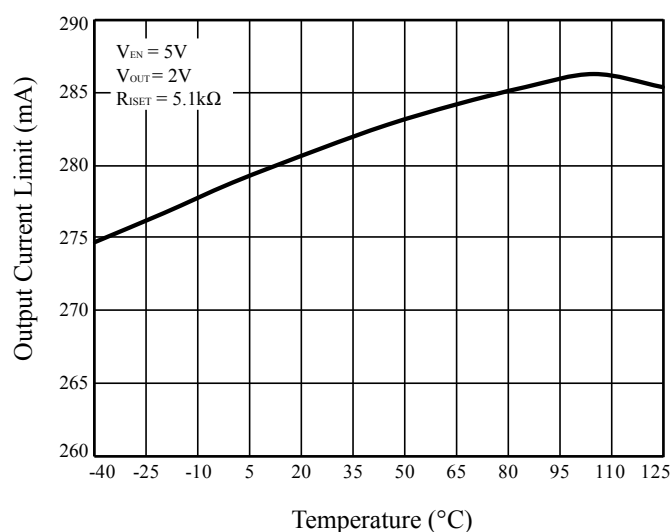
**Figure 31**  $I_{EN}$  vs.  $V_{EN}$



**Figure 32** Output Current vs.  $R_{ISET}$

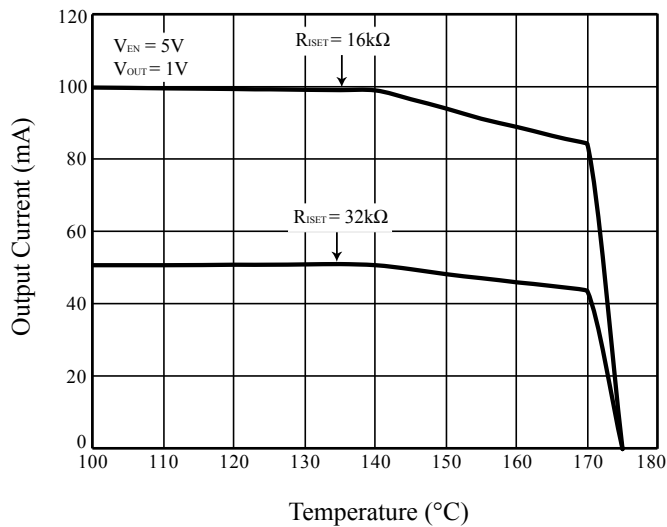


**Figure 33** Output Current vs. Temperature

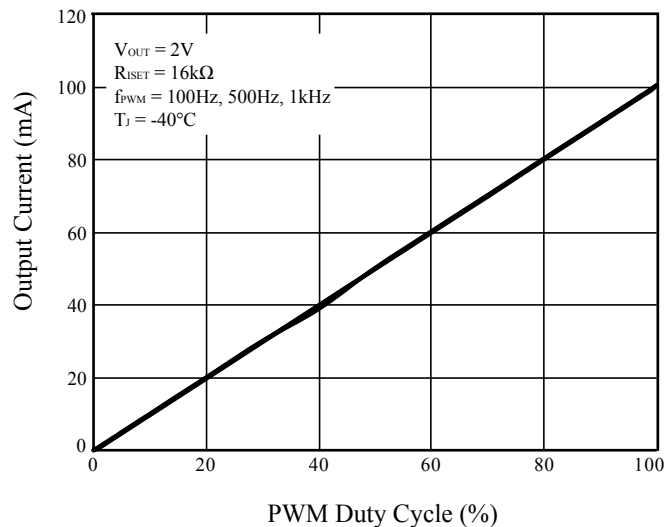


**Figure 34** Output Current Limit vs. Temperature

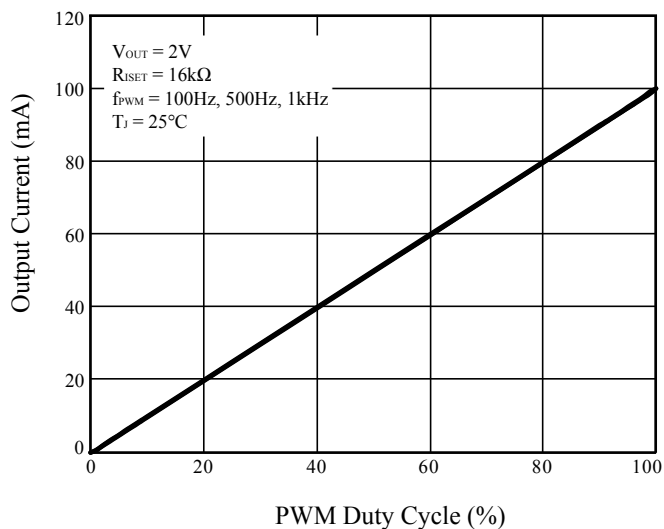
# IS31LT3177/78



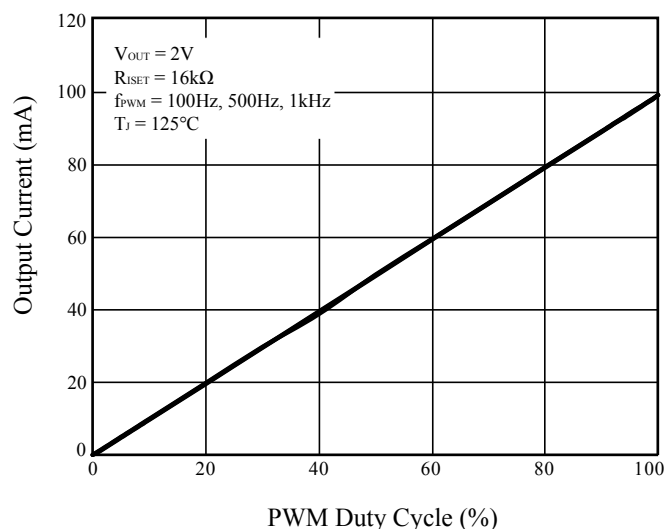
**Figure 35** Output Current vs. Temperature (Thermal Roll Off)



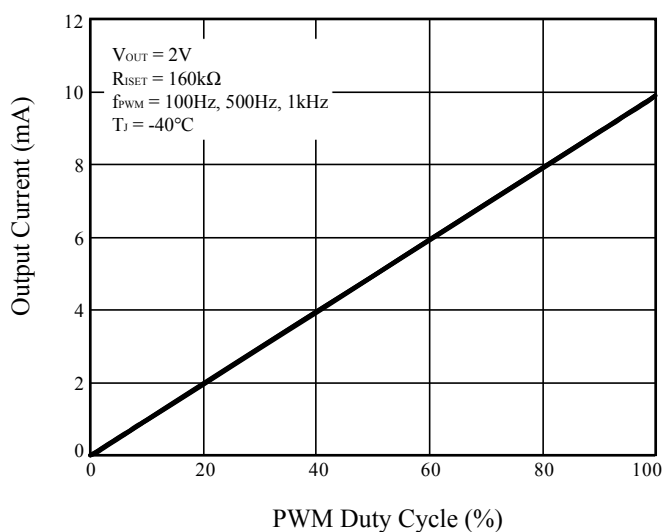
**Figure 36** Output Current vs. PWM Duty Cycle



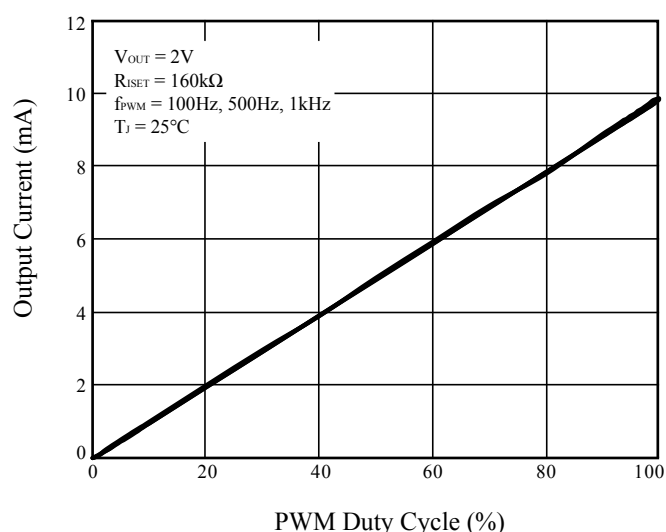
**Figure 37** Output Current vs. PWM Duty Cycle



**Figure 38** Output Current vs. PWM Duty Cycle



**Figure 39** Output Current vs. PWM Duty Cycle



**Figure 40** Output Current vs. PWM Duty Cycle

# IS31LT3177/78

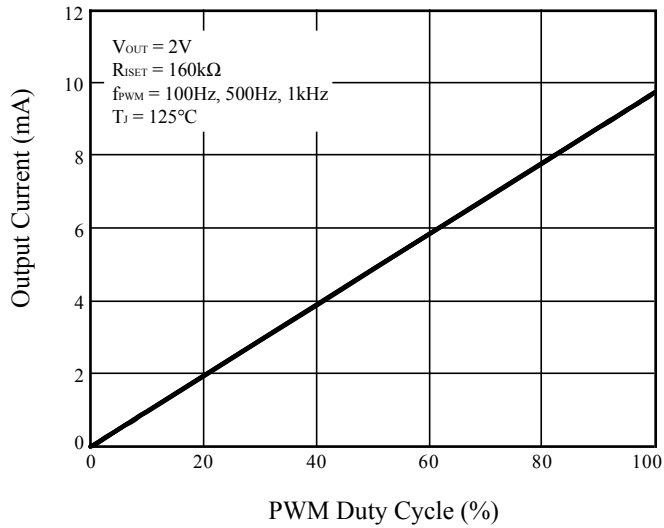


Figure 41 Output Current vs. PWM Duty Cycle

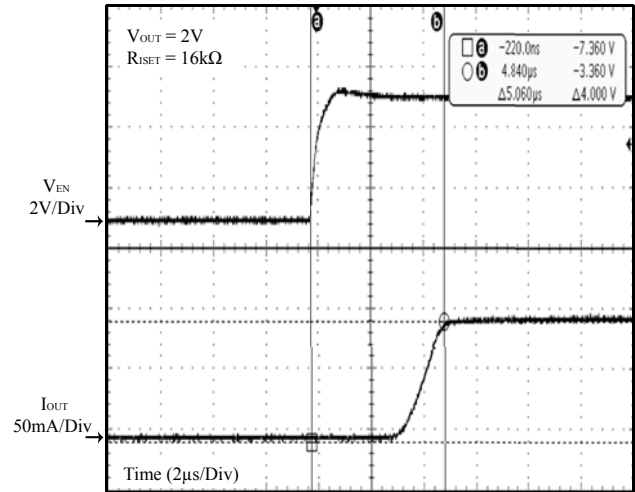


Figure 42 Start Up

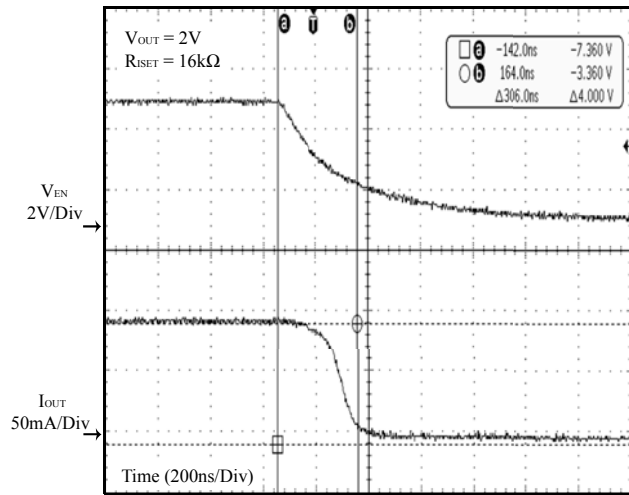


Figure 43 Shut Down

# IS31LT3177/78

## APPLICATIONS INFORMATION

IS31LT3177/78 provides an easy constant current sink solution for LED lighting applications. It uses an external resistor to adjust the LED current from 10mA to 150mA (SOT23-6)/200mA (SOP-8-EP). The LED current can be determined by the external resistor  $R_{ISET}$  as Equation (1):

$$R_{ISET} = \frac{V_{ISET} \times 1600}{I_{SET}} \quad (1)$$

$10.6k\Omega \leq R_{ISET} \leq 160k\Omega$  for SOT23-6 package, and  $8k\Omega \leq R_{ISET} \leq 160k\Omega$  for SOP-8-EP package.

Where  $R_{ISET}$  is in  $\Omega$ ,  $I_{SET}$  is desired LED current in Amp and  $V_{ISET} = 1.0V$  (Typ.)

$R_{ISET}$  must be a 1% accuracy resistor with good temperature characteristics in order to ensure stable output current. The device limits the maximum output current to  $I_{OUT\_LIMIT}$  to protect itself from an output overcurrent condition caused by a low value. Do not leave ISET pin floating.

### HIGH INPUT VOLTAGE APPLICATION

When driving a long string of LEDs whose total forward voltage drop exceeds the IS31LT3177  $V_{BD\_OUT}$  limit of 40V, it is possible to stack several LEDs (such as 2 LEDs) between the EN pin and the OUT pins, and so the voltage on the EN pin is higher than 5V. The remaining string of LEDs can then be placed between power supply  $+V_S$  and EN pin, (Figure 44). The number of LEDs required to stack at EN pin will depend on the LED's forward voltage drop ( $V_F$ ) and the  $+V_S$  value.

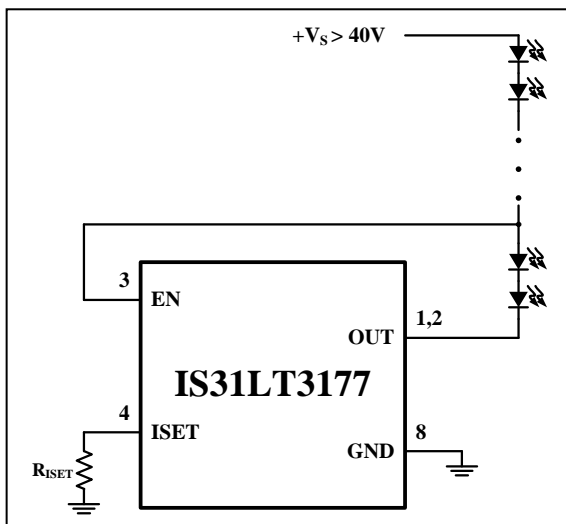


Figure 44 High Input Voltage Application Circuit

Note: when operating the IS31LT3177 at voltages exceeding the device operating limits, care needs to be taken to keep the EN pin and OUT pin voltage below 40V.

## THERMAL PROTECTION AND DISSIPATION

The IS31LT3177/78 implements thermal roll off protection to reduce the LED current when the package's thermal dissipation is exceeded and prevent "thermal runaway". The thermal roll off begins from 145°C, and linearly decreases following the junction temp to 85% of the set current value at  $T_{SD}$  (170°C). Please see Figure 14 and 35. In the event that the junction temperature exceeds 170°C, the device will go into shutdown mode. At this point, the IC begins to cool off and will resume operation once the junction temperature goes below 140°C.

When operating the chip at high ambient temperatures, or when driving maximum load current, care must be taken to avoid exceeding the package power dissipation limits. Exceeding the package dissipation will cause the device to enter thermal protection mode. The maximum package power dissipation can be calculated using the following Equation (2):

$$P_{D(MAX)} = \frac{T_{J(MAX)} - T_A}{\theta_{JA}} \quad (2)$$

Where  $T_{J(MAX)}$  is the maximum junction temperature,  $T_A$  is the ambient temperature, and  $\theta_{JA}$  is the junction to ambient thermal resistance; a metric for the relative thermal performance of a package.

The recommended maximum operating junction temperature,  $T_{J(MAX)}$ , is 125°C and so the maximum ambient temperature is determined by the package parameter;  $\theta_{JA}$ . The  $\theta_{JA}$  for the IS31LT3177/78 SOT23-6 package is 130°C/W and SOP-8-EP package is 43.1°C/W.

Therefore the maximum power dissipation at  $T_A = 25^\circ C$  is:

$$P_{D(MAX)} = \frac{125^\circ C - 25^\circ C}{130^\circ C / W} \approx 0.77W \text{ (SOT23-6)}$$

$$P_{D(MAX)} = \frac{125^\circ C - 25^\circ C}{43.1^\circ C / W} \approx 2.32W \text{ (SOP-8-EP)}$$

The actual power dissipation  $P_D$  is:

$$P_D = V_{OUT} \times I_{OUT} + V_{EN} \times I_{EN} \quad (3)$$

To ensure optimum performance, the die temperature ( $T_J$ ) of the IS31LT3177/78 should not exceed 125°C. The graph below gives details for the package power derating.



# IS31LT3177/78

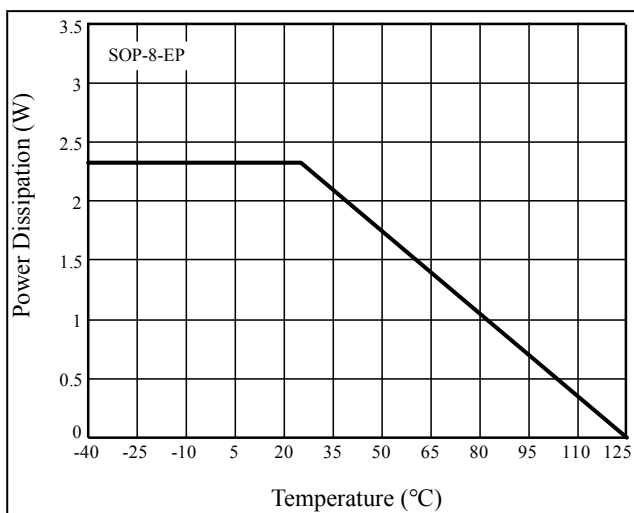
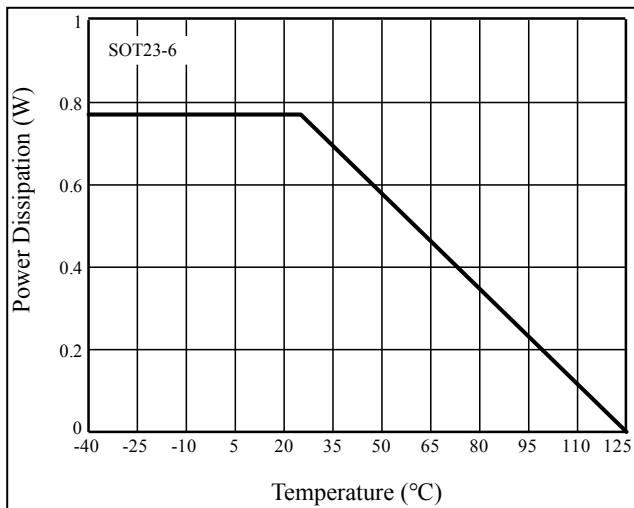


Figure 45  $P_D$  vs.  $T_A$

A lower thermal resistance is achieved by mounting the IS31LT3177/78 on a standard FR4 double-sided

printed circuit board (PCB) with a grounded copper area of a few square inches on each side of the board under the IS31LT3177/78. Multiple thermal solid vias (not web or spoke type), as shown in Figure 46, help to conduct heat from the exposed pad of the IS31LT3177/78 to the grounded copper area on each side of the board. The recommended via diameter is 0.5mm with spacing of 1mm. The thermal resistance can be further reduced by using a metal-clad PCB or by adding a heatsink.

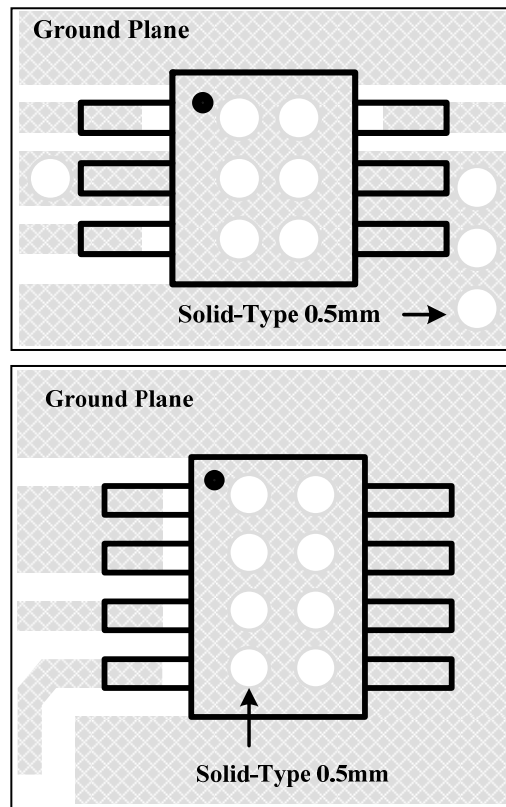


Figure 46 Board Via Layout For Thermal Dissipation

# IS31LT3177/78

## CLASSIFICATION REFLOW PROFILES

Profile Feature	Pb-Free Assembly
Preheat & Soak	150°C
Temperature min (T <sub>smin</sub> )	200°C
Temperature max (T <sub>smax</sub> )	60-120 seconds
Time (T <sub>smin</sub> to T <sub>smax</sub> ) (t <sub>s</sub> )	
Average ramp-up rate (T <sub>smax</sub> to T <sub>p</sub> )	3°C/second max.
Liquidous temperature (T <sub>L</sub> )	217°C
Time at liquidous (t <sub>L</sub> )	60-150 seconds
Peak package body temperature (T <sub>p</sub> )*	Max 260°C
Time (t <sub>p</sub> )** within 5°C of the specified classification temperature (T <sub>c</sub> )	Max 30 seconds
Average ramp-down rate (T <sub>p</sub> to T <sub>smax</sub> )	6°C/second max.
Time 25°C to peak temperature	8 minutes max.

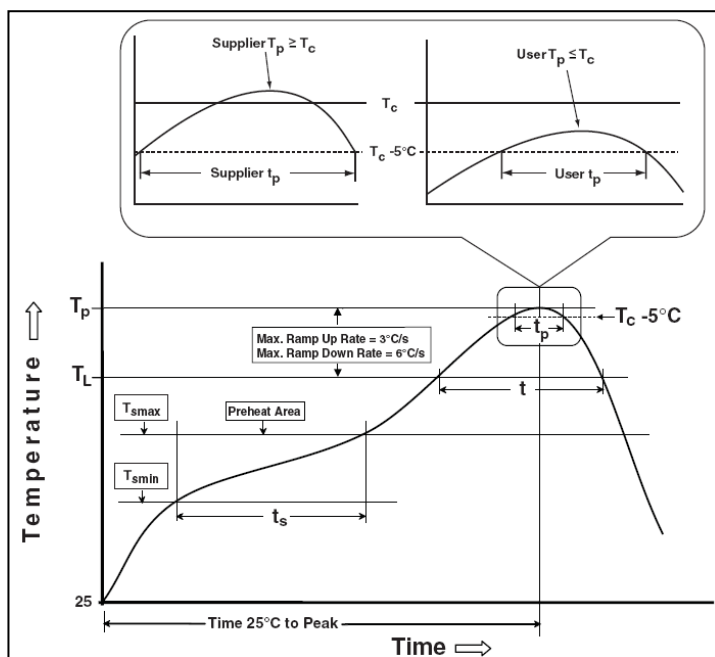
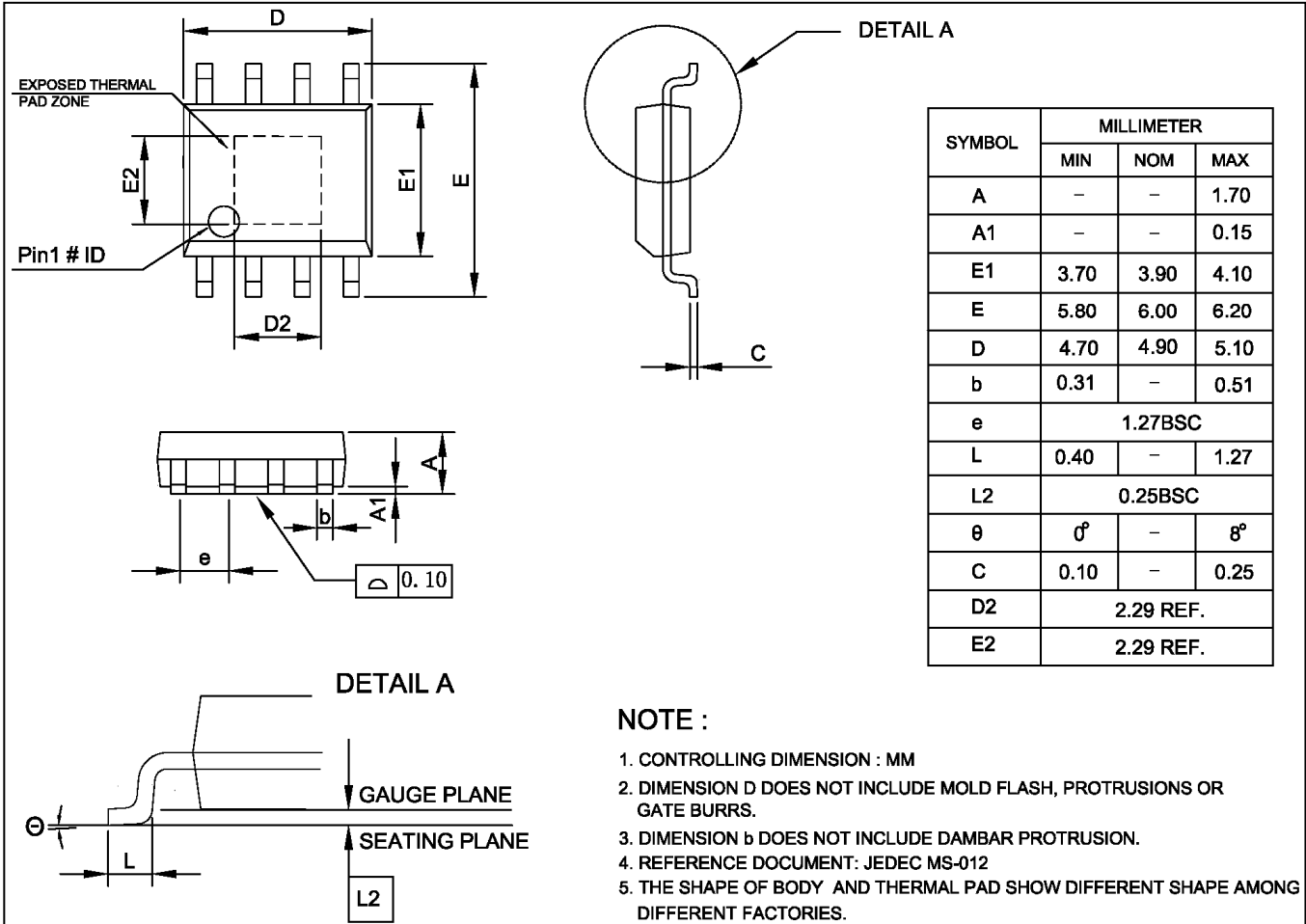


Figure 47 Classification Profile

# IS31LT3177/78

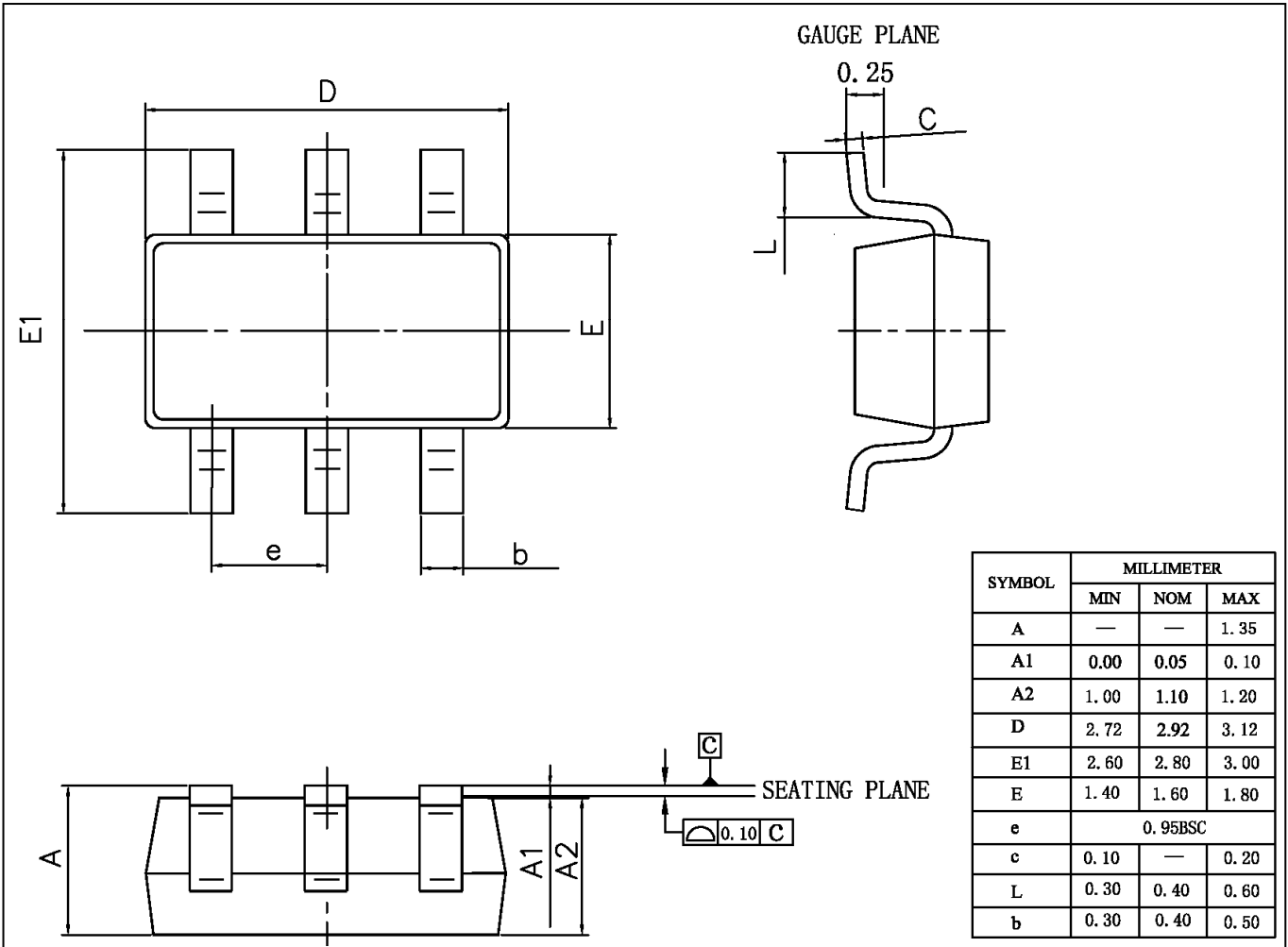
## PACKAGE INFORMATION

### SOP-8-EP



# IS31LT3177/78

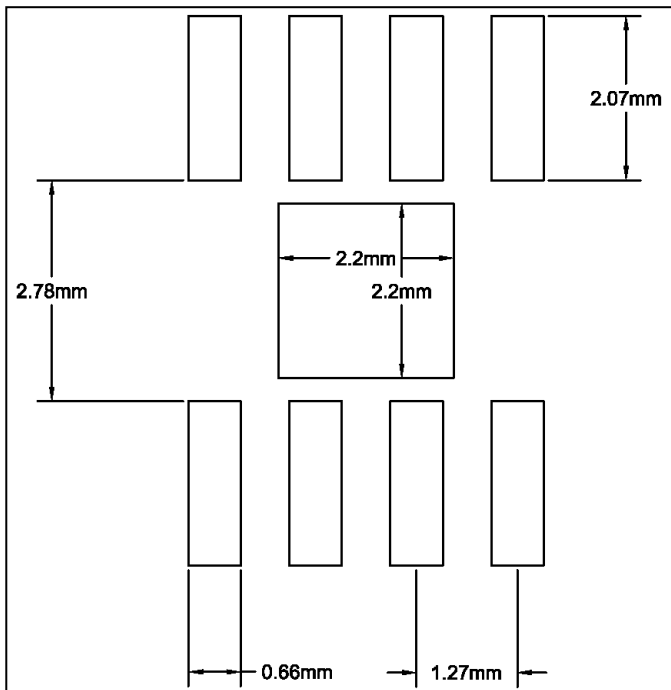
SOT-23-6



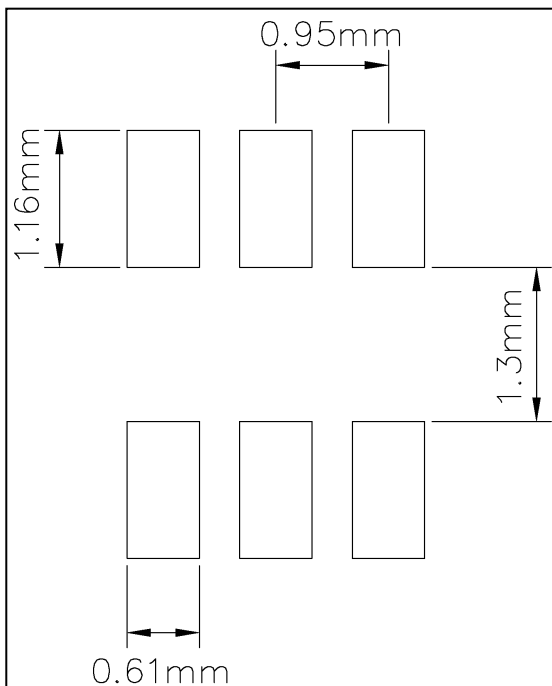
# IS31LT3177/78

## RECOMMENDED LAND PATTERN

### SOP-8-EP



### SOT-23-6



**Note:**

1. Land pattern complies to IPC-7851.
2. All dimensions in MM.
3. This document (including dimensions, notes & specs) is a recommendation based on typical circuit board manufacturing parameters. Since land pattern design depends on many factors unknown (eg. User's board manufacturing specs), user must determine suitability for use.