

IS32LT3957/IS31LT3957 BUCKBOOST EVALUATION BOARD

DESCRIPTION

The IS32LT3957/IS31LT3957 is a current mode PWM controller designed to drive a low side external NMOS FET for wide input/output voltage range and high LED current applications. An external resistor senses the high side output current of the LED string. A high side sense is the most flexible current sensing scheme, since it functions in either boost or buck-boost mode configurations. The controller can be configured with an external resistor to operate between 100kHz~1MHz frequency resulting in small external inductor and capacitors while maintaining high efficiency. A single capacitor is all that is required to set the spread spectrum dither frequency to reduce the radiated peak emission and optimize the system EMI performance.

The IS32LT3957/IS31LT3957 integrates circuitry to detect output open/short, RT/SYNC pin short, VDD short, VCC under voltage lockout and over temperature fault conditions. These failure conditions can be reported by the open drain fault reporting FAULTB pin.

An MCU can be easily interfaced with the IS32LT3957/IS31LT3957 to perform dimming control and respond to fault report conditions. Dimming can be either analog and/or PWM input. An input DC voltage in the range of 0.1V ~ 1.1V on the ICTRL pin is required for analog dimming. A digital signal with varying duty cycle on the PWM/EN pin will achieve PWM dimming.

The IS32LT3957/IS31LT3957 is available in an eTSSOP-16 package with an exposed pad for enhanced thermal dissipation. It operates from 5V to 75V over the temperature range of -40°C to +125°C.

EVALUATION BOARD PHOTO

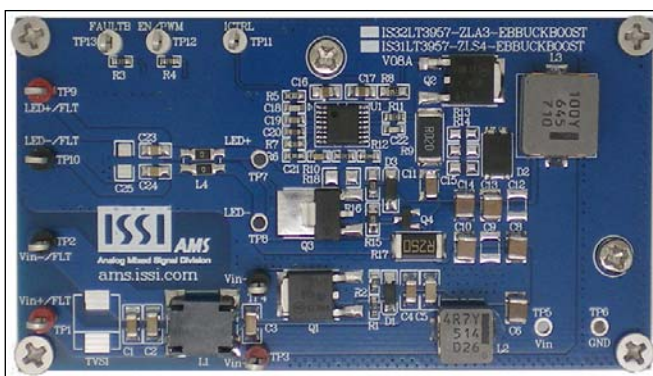

Figure 1 Photo of IS32LT3957/IS31LT3957 BuckBoost Evaluation Board

FEATURES

- Wide high voltage input range: 5V to 75V
- Supports boost, buck-boost, SEPIC and buck topology
- $\pm 3.5\%$ output current accuracy over $-40^{\circ}\text{C} \sim +125^{\circ}\text{C}$ temperature
- Adjustable operating frequency range of 100kHz~1MHz
- Programmable soft start to avoid inrush current
- Fixed under voltage lockout threshold
- EMI reduction capabilities
 - Programmable spread spectrum function
 - Operating frequency synchronization with external clock source
- Supports either analog or PWM dimming
- Fault protection with reporting:
 - VCC under voltage lockout (not reported)
 - Programmable output over voltage protection
 - Output short circuit protection
 - RT/SYNC pin short protection
 - VDD pin short protection
 - VDD under voltage lockout (not reported)
 - Over temperature protection
- AEC-Q100 Qualified (IS32LT3957 only)

RECOMMENDED EQUIPMENT

- 9~16V, 6A DC power supply
- LED load (7~10 LEDs in series/1A)
- Multi-meter

ABSOLUTE MAXIMUM RATINGS

- $\leq 40\text{V}$ power supply

Caution: Do not exceed the conditions listed above, otherwise the board will be damaged.

TEST PROCEDURE

The IS32LT3957/IS31LT3957 evaluation board is fully assembled and tested. Follow the steps listed below to verify board operation.

Caution: Do not turn on the power supply until all connections are completed.

- 1) Connect the positive terminal of the power supply to the Vin+/FLT (TP1 terminal) of the board and the negative terminal of the power supply to the Vin-/FLT (TP2 terminal) of the board.
- 2) Connect the Cathode of the LED load to the LED-/FLT (TP10 terminal) of the board. And connect the Anode of the LED load to the LED+/FLT (TP9 terminal) of the board.
- 3) If testing PWM dimming, apply an external PWM

IS32LT3957/IS31LT3957 BUCKBOOST EVALUATION BOARD

- signal to the EN/PWM (TP12 terminal) of the board. If PWM dimming not tested, leave EN/PWM (TP12 terminal) floating and the output PWM will be 100%.
- 4) If testing analog dimming, apply an external 0.1~1.1V voltage signal to ICTRL (TP11 terminal) of the board. If analog dimming not tested, leave ICTRL (TP11 terminal) floating and the output will be 100%.
 - 5) FAULTB (TP13 terminal) is the fault reporting output, which is pulled up to VCC by R3 on board. It will be pulled low whenever a fault condition is detected. Please refer to table 2 for more details on fault conditions. If not tested, leave FAULTB (TP13 terminal) floating.
Note 1: If connected to an MCU, please remove R3 and pull up by a 10KΩ resistor at the MCU side to avoid MCU damage due to high voltage on the VCC pin.
 - 6) Turn on the power supply and the LED load will light up.
 - 7) To measure the output current, please connect the current meter (multi-meter) in series with the LED load. No matter the power supply voltage or output LED load voltage are changed (in SPEC), the output current of the evaluation board will be always constant.
Note 2: if the LED load is fixed which means the output power is constant, the power supply current will change following the power supply voltage. The lower power supply voltage the higher power supply current. Please pay attention to the current limit of your power supply, especially at lower power supply voltage.
 - 8) This evaluation board includes an EMI suppression filter circuit and is designed to meet the CISPR-25 conducted EMI standard. To meet class 5 level, the power supply must be connected to VIN+/FLT (TP1 terminal) and VIN-/FLT (TP2 terminal). To save the input common mode chock, connecting the power supply to VIN+ (TP3 terminal) and VIN- (TP4 terminal) still can meet class 4 level.

CAUTION!!! Since the output power is quite high while the DEMO board dimension is compact, the temperature of the components will be quite high. DO NOT touch the components during operation. In practice, some type of heatsinking should to be considered, such as mount a larger heatsink and fill with thermal conductive glue for cooling to ensure thermal reliability.

ORDERING INFORMATION

Part No.	Temperature Range	Package
IS32LT3957-ZLA3-EBBUCKBOOST	-40°C to +125°C (Automotive)	eTSSOP-16, Lead-free
IS31LT3957-ZLS4-EBBUCKBOOST	-40°C to +125°C (Industrial)	

Table 1 Ordering Information

For pricing, delivery, and ordering information, please contact Lumissil's analog marketing team at analog@Lumissil.com or (408) 969-6600.

IS32LT3957/IS31LT3957 BUCKBOOST EVALUATION BOARD

OPERATION FREQUENCY

The internal oscillator of IS32LT3957 /IS31LT3957 is programmable from 100kHz to 1MHz range using a single resistor R_{RT} (R7 in the schematic) at RT/SYNC pin. Higher frequency operation results in smaller component size but increases the switching losses and power NMOS gate driving current, and may not allow sufficiently high or low duty cycle. Lower frequency gives better performance but results in larger component size. To set a desired frequency, the resistor value can be calculated by following Equation (1):

$$R_{RT} = \frac{37.5 \times 10^9}{f_{SW}} \quad (1)$$

Where R_{RT} is in ohm. f_{SW} is the operating frequency in Hertz.

If the RT/SYNC pin is connected to an extremely low value resistor or accidentally shorted to ground, the internal oscillation frequency will be over 1MHz. If it exceeds 2.5MHz, the internal circuit will detect it and turn off the power NMOS for protection. When this fault condition is removed so the frequency drops below 2.5MHz, the operation will recovery.

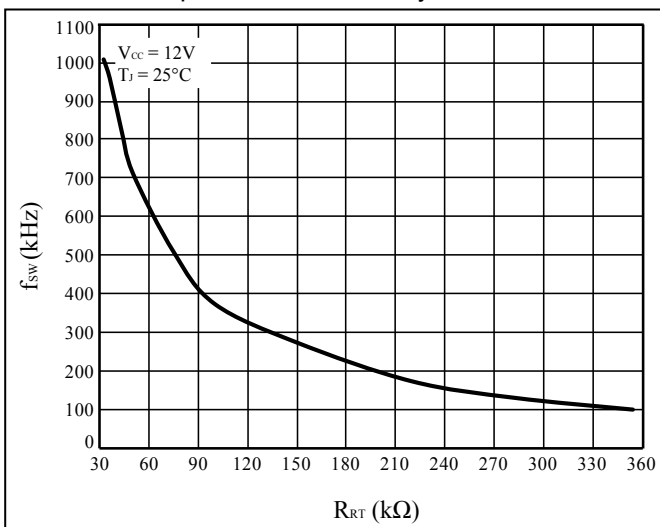

Figure 2 f_{SW} vs. R_{RT}

LED CURRENT CONTROL

The IS32LT3957/IS31LT3957 regulates the LED current by the external resistor, R_{IS} (R17 in the schematic), in series with LED string and connecting to ISP and ISN. The internal current sense voltage threshold V_{SENSE} , which is equal to $V_{ISP} - V_{ISN}$, is 0.25V (Typ.). To get best output accuracy, sensing of the output current should be done on the top of the LED string. When the PWM/EN pin is tied to a DC voltage higher than 2.0V and ICTRL voltage is above 1.1V, will result in a full-scale current sense voltage threshold and the LED current can be calculated from Equation

(2).

$$I_{LED} = \frac{V_{SENSE}}{R_{IS}} \quad (2)$$

In order to have an accurate LED current, precision resistors are preferred ($\pm 1\%$ recommended). The R_{IS} resistor should be placed as close as possible to the IS32LT3957/IS31LT3957 device with minimal trace length.

FAULT DETECTION AND REPORTING

For added system reliability, the IS32LT3957/IS31LT3957 integrates various fault detection and protection circuitry for LED string open/short circuit, VCC and VDD UVLO, power NMOS over current, RT/SYNC and VDD pins short circuit and over temperature conditions. The open drain pin FAULTB can be used as a fault condition flag. When it's monitored by a host, a pull up resistor from the FAULTB pin to the supply of the host is needed. It is pulled low to report the fault conditions. Table 2 briefly describes the typical protection trigger conditions and device behavior.

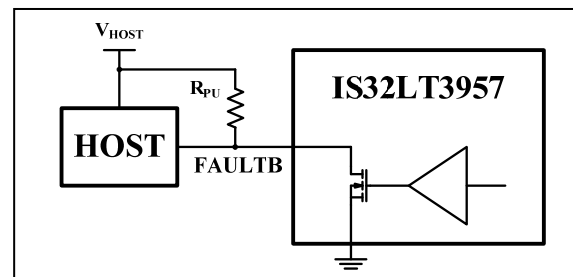

Figure 3 Host Monitors The Fault Reporting

SETTING THE OVER VOLTAGE PROTECTION

The open LED string protection is achieved using over voltage protection (OVP). In some cases, when the output voltage reaches the programmed OVP voltage (V_{OVP}), the GATE and DIMOUT pins are immediately pulled low and the FAULTB pin is also pulled low to report the fault condition. They remain low until the output voltage drops below the hysteresis voltage. To make sure the chip functions properly, the resistor divider R_{O1}/R_{O2} (R10, R12 in the schematic) at the OVP pin must be set to 1.2x greater than the output voltage, V_{OUT} . For boost and SEPIC applications, V_{OUT} is equal to the LED string voltage. For buck-boost applications, V_{OUT} is equal to the input voltage (V_{CC}) plus the LED string voltage.

The OVP voltage is calculated using Equation (3).

$$V_{OVP} = \frac{V_{OVP_TH} \times (R_{O1} + R_{O2})}{R_{O2}} \geq 1.2 \times V_{OUT} \quad (3)$$

IS32LT3957/IS31LT3957 BUCKBOOST EVALUATION BOARD

It is recommend to connect a 1nF ceramic capacitor from the OVP pin to GND to avoid unexpected noise coupling into this pin.

Note, the OVP voltage should not be set much higher than V_{OUT} , otherwise the power NMOS, the dimming MOS, the recirculating diode and the output capacitor would require higher voltage ratings.

IS32LT3957/IS31LT3957 BUCKBOOST EVALUATION BOARD

Table 2 Fault Actions

Fault Type	Fault Condition	Device Operation After Fault	FAULTB Pin	Fault Reset
VCC UVLO	$V_{CC} < V_{UVLO_F}$	GATE and DIMOUT pull low immediately. IC enters into standby mode and COMP resets to zero.	High Impedance	$V_{CC} > V_{UVLO_R}$
VDD UVLO	$V_{CC} < V_{UVLO_F}$	GATE pulls low immediately. IC enters into standby mode and COMP resets to zero.	High Impedance	$V_{CC} > V_{UVLO_R}$
VDD Pin Short	After startup and $V_{DD} < 1.4V$	GATE pulls low immediately. IC enters into standby mode and COMP resets to zero.	Pull Low	$V_{DD} > 1.4V$
Over Voltage (LED Open)	$V_{OUT} \geq V_{OVP}$	GATE pulls low immediately. IC enters into standby mode and COMP resets to zero.	Pull Low	$V_{OUT} < (V_{OVP} - \text{Hysteresis})$
Power NMOS Current Limit	$V_{CS} > V_{CS_TH}$	GATE pulls low immediately until the next switching cycle.	High Impedance	$V_{CS} < V_{CS_TH}$
LED String Short (Boost Only)	$(V_{ISP} - V_{ISN}) > V_{SENSE_OC}$	GATE and DIMOUT pull low immediately and COMP resets to zero. And retry after 16,000 f_{SW} cycles.	Pull Low	$(V_{ISP} - V_{ISN}) < V_{SENSE_OC}$
RT/SYNC Pin Short	$f_{SW} > 2.5MHz$	GATE pulls low immediately.	Pull Low	$f_{SW} < 2.5MHz$
Thermal Shutdown	$T_J > 165^\circ C$	GATE pulls low immediately. IC enters into standby mode and COMP resets to zero.	Pull Low	$T_J < 145^\circ C$

SCHEMATIC

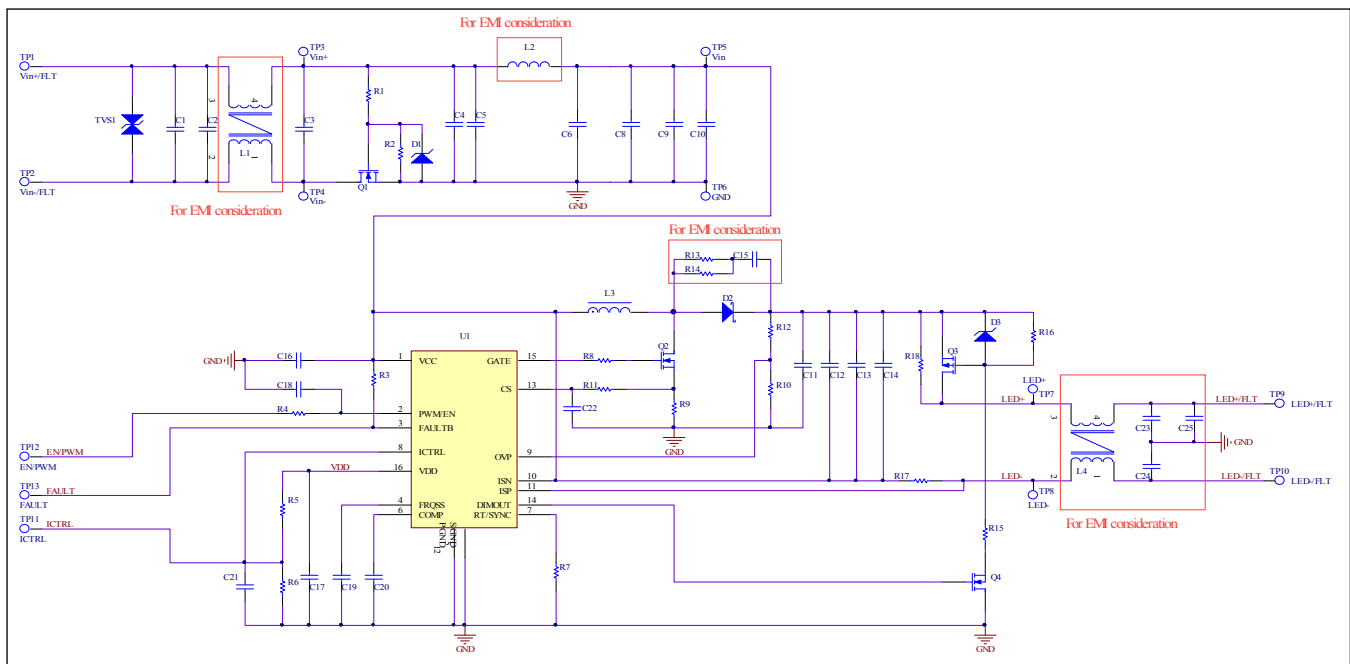

Figure 4 IS32LT3957/IS31LT3957 DEMO Schematic

Note 3: R1, R2, D1 and Q1 form an ideal diode as low loss input reverse polarity protection. They can be replaced by a lower cost Schottky diode, however the much higher forward voltage on Schottky diode will degrade the efficiency and increase thermal on board.

Note 4: The EMI filtering circuits are optional. Using different external components, PCB layout, parameter setting may result in a significantly different EMI performance. Please fine tune EMI filtering circuit based on your actual EMI scan result.

IS32LT3957/IS31LT3957 BUCKBOOST EVALUATION BOARD

BILL OF MATERIALS

Name	Symbol	Description	Qty	Supplier	Part No.
-	TVS1,R18,R13,R14, C9,C12,C15,C25,L4	NC			
PCB	-	87mm × 47mm, FR-4, 4 layers, 1oz copper	1	-	-
LED Driver	U1	Constant current LED driver	1	Lumissil	IS32LT3957/IS31LT3957
Capacitor	C1,C4	CAP,2.2μF,50V,±10%,SMD	2	Yageo	AC1206KRX7R9BB225
Capacitor	C2,C3,C5	CAP,0.1μF,50V,±10%,SMD	3	Yageo	AC1206KRX7R9BB104
Capacitor	C6,C8,C10,C13,C14	CAP,10μF,50V,±10%,SMD	5	Murata	GRM32ER71H106KA12L
Capacitor	C11	CAP,1μF,50V,±10%,SMD	1	Yageo	AC1206KKX7R9BB105
Capacitor	C16,C17	CAP,1μF,50V,±10%,SMD	2	Yageo	AC0805KKX7R9BB105
Capacitor	C18	CAP,33pF,50V,±10%,SMD	1	Yageo	AC0603KRX7R9BB330
Capacitor	C19	CAP,0.1μF,50V,±10%,SMD	1	Yageo	AC0603KRX7R9BB104
Capacitor	C20	CAP,220nF,50V,±10%,SMD	1	Yageo	AC0603KKX7R9BB224
Capacitor	C21	CAP,10nF,50V,±10%,SMD	1	Yageo	AC0603KRX7R9BB103
Capacitor	C22	CAP,10pF,50V,±10%,SMD	1	Yageo	AC0603KRX7R9BB100
Capacitor	C23,C24	CAP,22nF,50V,±10%,SMD	2	Yageo	AC0805KRX7R9BB223
Resistor	R1,R3,R10	RES,10k,0603,±5%,SMD	3	Yageo	AC0603FR-0710KL
Resistor	R4	RES,1k,0603,±5%,SMD	1	Yageo	AC0603FR-071KL
Resistor	R2	RES,39k,0603,±5%,SMD	1	Yageo	AC0603FR-0739KL
Resistor	R5	RES,30k,0603,±5%,SMD	1	Yageo	AC0603FR-0730KL
Resistor	R6	RES,20k,0603,±5%,SMD	1	Yageo	AC0603FR-0720KL
Resistor	R7	RES,100k,0603,±5%,SMD	1	Yageo	AC0603FR-07100KL
Resistor	R8	RES,15R,0805,±5%,SMD	1	Yageo	AC0805FR-070150L
Resistor	R9	RES,0.020R,2512,±1%,SMD	1	UniOhm	25121WF200MT4E
Resistor	R11	RES,100R,0603,±5%,SMD	1	Yageo	AC0603FR-07101L
Resistor	R12	RES,390k,0603,±5%,SMD	1	Yageo	AC0603FR-07390KL
Resistor	R15	RES,6.2k,0805,±5%,SMD	1	Yageo	AC0805FR-076K2L
Resistor	R16	RES,2k,0805,±5%,SMD	1	Yageo	AC0805FR-072KL
Resistor	R17	RES,0.25R,2512,±1%,SMD	1	UniOhm	25121WF250LT4E
MOSFET	Q1,Q2	22A,60V,NMOS	2	ON	NVD5867NLT4G
MOSFET	Q3	-3.5A,-60V,PMOS	1	DIODES	ZXMP6A17GTA
MOSFET	Q4	75mA,60V,NMOS	1	ON	2V7002LT3G
Diode	D1,D3	DIODE ZENER 6.5V	2	Littelfuse	SMF6.5AG
Diode	D2	5A,100V	1	Littelfuse	DST5100S-A
SMD Inductor	L1	700Ω@100MHZ, IR=5A	1	TDK	ACM90V-701-2PL-TL00
SMD Inductor	L2	4.7μH±20%, I _R =6.3A	1	Panasonic	ETQP5M4R7YFM
SMD Inductor	L3	10μH±20%, I _{SAT} ≥7.1A	1	Panasonic	ETQP5M100YFC

IS32LT3957/IS31LT3957 BUCKBOOST EVALUATION BOARD

PCB LAYOUT (SIZE: 87mm x 47mm, FR-4, 4 LAYERS, 10Z COPPER)

Note 5: Since the PCB layout is very critical for the EMI performance, please follow this PCB layout's components placement and trace routing for better EMI performance. If need, please contact Lumissil to acquire the PCB layout files/application note for your PCB layout reference.

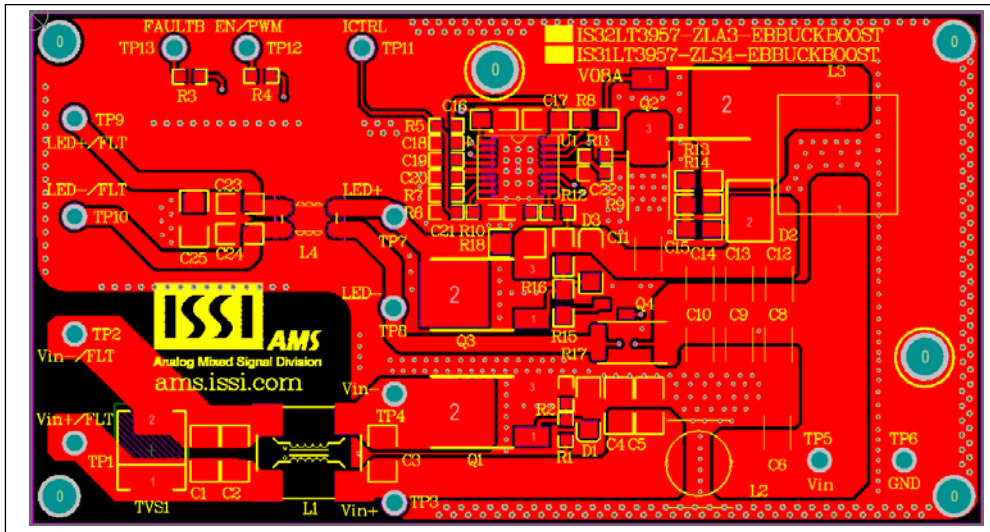

Figure 5 Board Top Layer

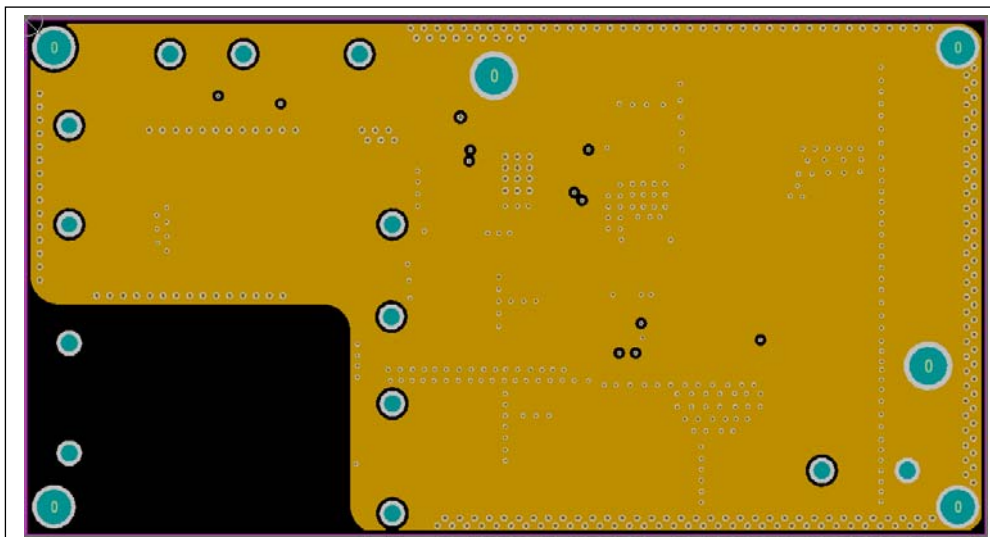

Figure 6 Board Middle Layer Top

IS32LT3957/IS31LT3957 BUCKBOOST EVALUATION BOARD

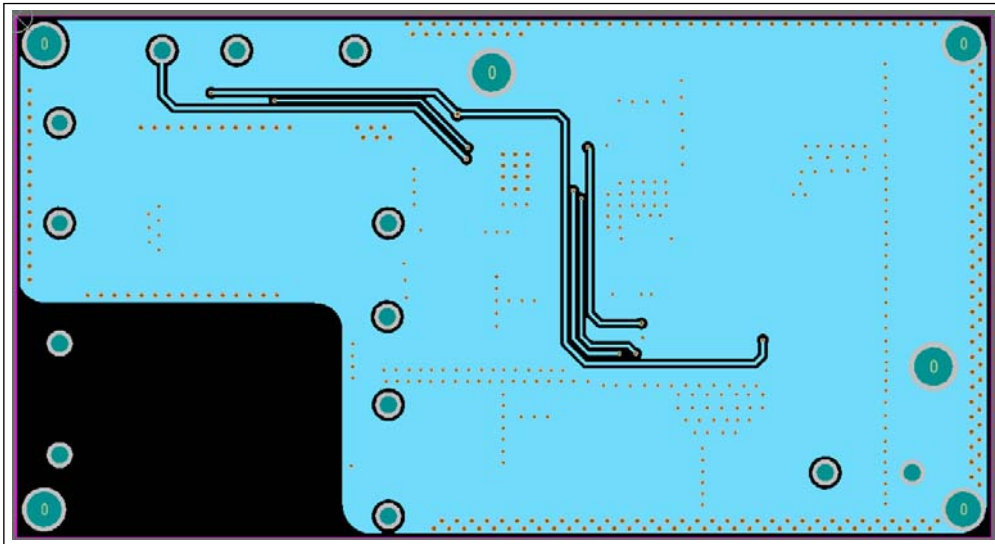

Figure 7 Board Middle Layer Bottom

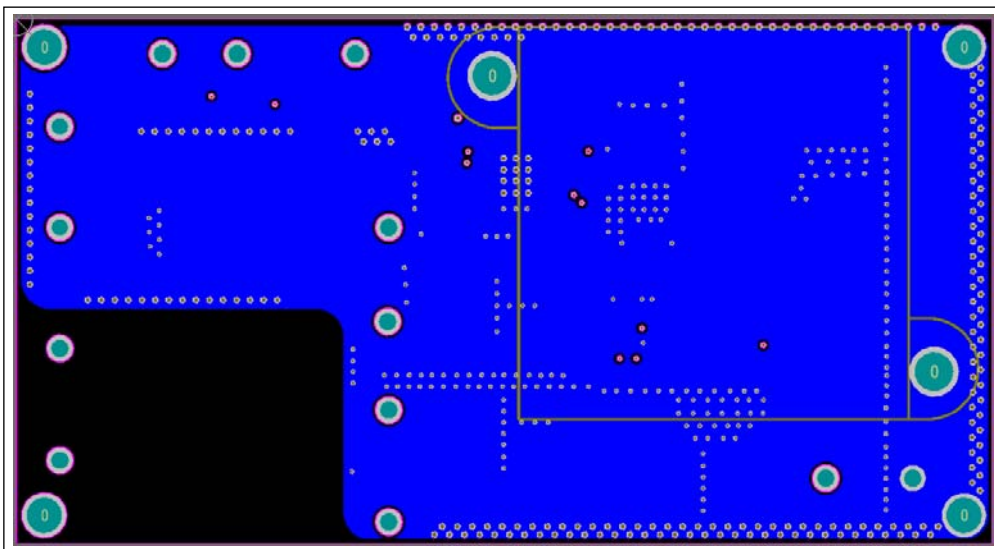

Figure 8 Board Bottom Layer

IS32LT3957/IS31LT3957 BUCKBOOST EVALUATION BOARD

CONDUCTED EMI PERFORMANCE

Test condition: $V_{IN}=12V$, $V_{LED}=30V$, $I_{LED}=1A$, naked board without any shielding

Test standard: CISPR-25 Class 5 and Class 4 conducted EMI (Blue: Peak scanning, Green: Average scanning)

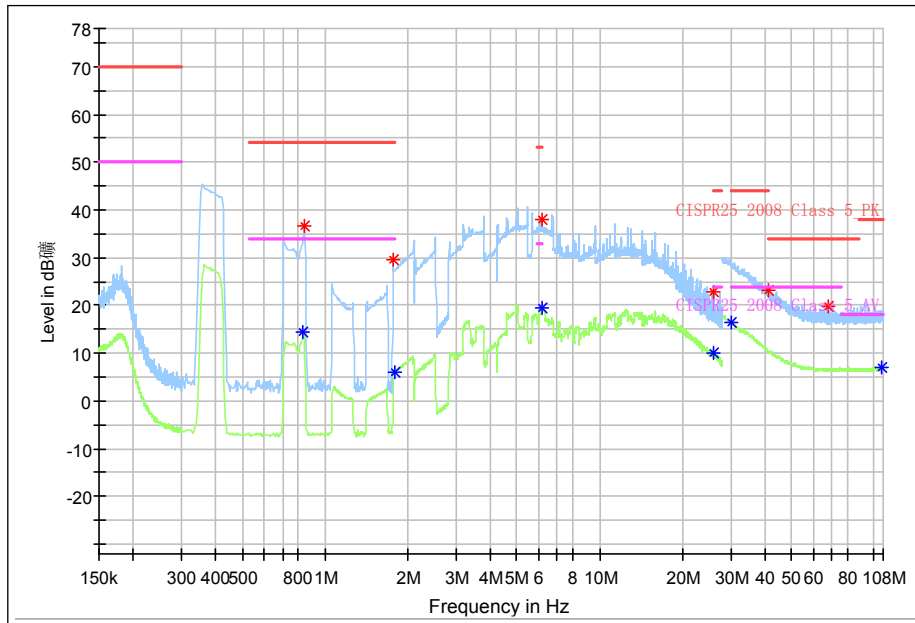

Figure 9 CISPR-25 Class 5 Conducted EMI Scan (With The Input Common Mode Chock)

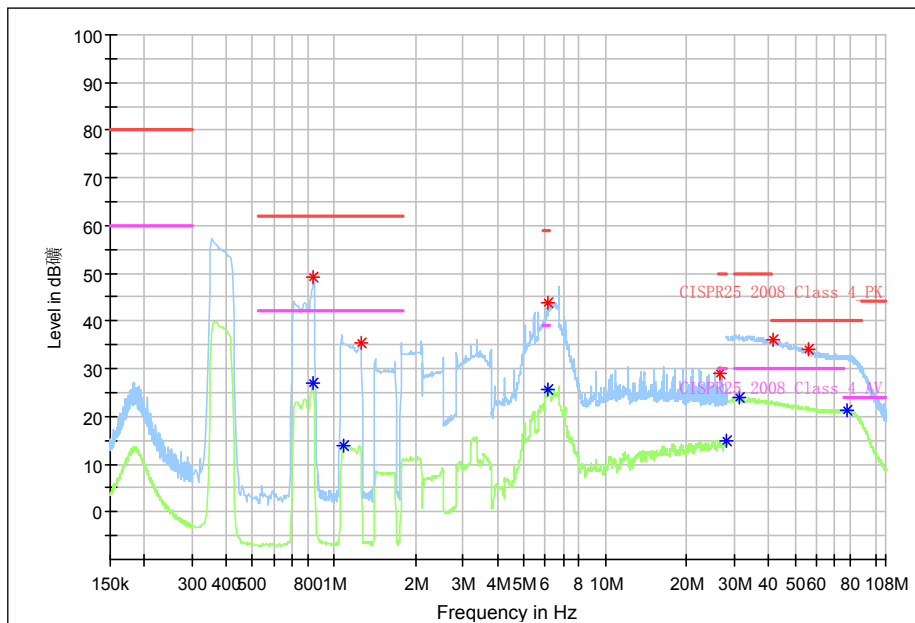

Figure 10 CISPR-25 Class 4 Conducted EMI Scan (Without The Input Common Mode Chock)

EFFICIENCY AND LINE REGULATION

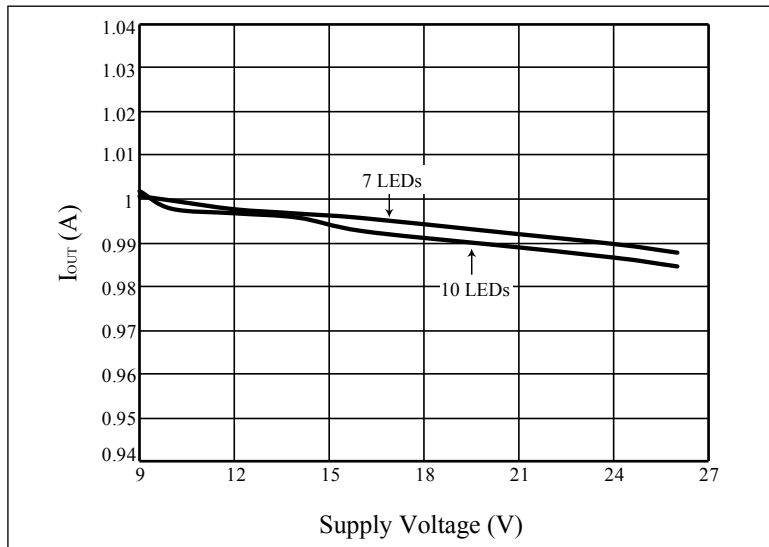

Figure 11 Line Regulation

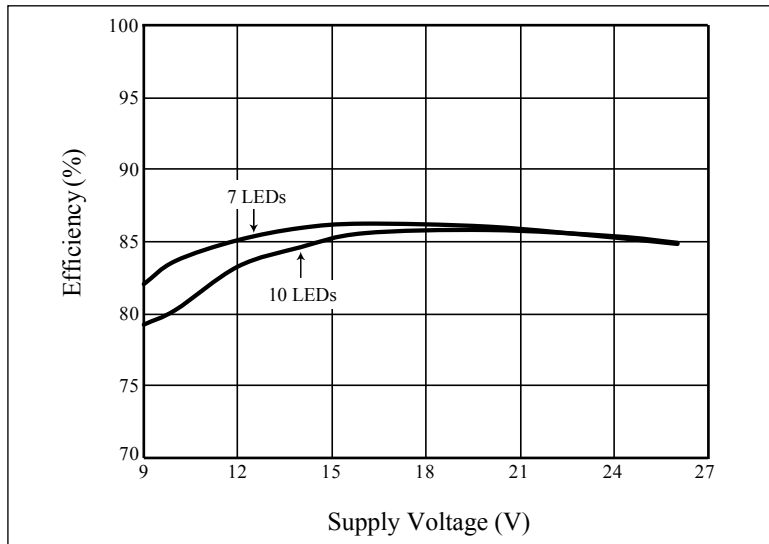

Figure 12 Efficiency vs. V_{IN}

Copyright © 2019 Lumissil Microsystems. All rights reserved. Lumissil Microsystems reserves the right to make changes to this specification and its products at any time without notice. Lumissil Microsystems assumes no liability arising out of the application or use of any information, products or services described herein. Customers are advised to obtain the latest version of this device specification before relying on any published information and before placing orders for products.

Lumissil Microsystems does not recommend the use of any of its products in life support applications where the failure or malfunction of the product can reasonably be expected to cause failure of the life support system or to significantly affect its safety or effectiveness. Products are not authorized for use in such applications unless Lumissil Microsystems receives written assurance to its satisfaction, that:

- a.) the risk of injury or damage has been minimized;
- b.) the user assume all such risks; and
- c.) potential liability of Lumissil Microsystems is adequately protected under the circumstances