

Specification

- Part No. : **ISA.05.A.033822**
- Product Name : 915 MHz ISM Band Adhesive Mounted Patch Antenna
for Internal Applications
- Features : Double-Sided 3M Adhesive Mounted Antenna
5dBi Peak Gain mounted on 30cm Square Ground
0dBi Peak Gain In Free Space
Dimensions: 80x50.5x11 mm
300 mm Φ 1.37 cable
IPEX MHFHT connector (U.FL compatible)
IP65 water-proof
Cable and connector customizable

RoHS Compliant



1. Introduction

The Taoglas ISA.05 adhesive mounted antenna is designed primarily for 915 MHz ISM Band compact wireless applications where it may or may not be attached to metal.

When placed on a reference 30cm square ground-plane, the antenna has an excellent directional hemispherical radiation pattern, high peak gain of 5dBi at zenith, and an efficiency of 68%.

Even without a ground-plane underneath, the antenna achieves 0dBi and an efficiency of 45%.

The antenna is IP65 water-resistant and comes standard with a Micro-Coaxial cable with 1.37mm diameter and IPEX MHFHT connector. The Taoglas ISA.05 is an excellent solution for the following applications:

- Environments where there are lots of metal objects that it may be mounted to (such as near a car engine)
- RFID Readers
- Short range 915MHz mesh networks

Cable type, length, and connector can be customized. Mechanical customization of the antenna can also be done for a minimum order quantity. Please contact your regional Taoglas office for more details.

2. Specification

ELECTRICAL						
ISM 915 MHz Band						
Measurement Environment	Free Space			Direct On 30cm * 30cm Ground Plane		
Operation Frequency (MHz)	902	915	928	902	915	928
Return Loss (dB)	-5	-6	-3	-3	-11	-3
VSWR	3.6	3	5.9	5.9	2	5.9
Efficiency (%)	46.25	47.51	18.55	26.36	68.94	62.64
Peak Gain (dBi)	0.52	-0.02	-4.10	0.83	5.12	4.77
Average Gain (dBi)	-3.34	-3.23	-7.31	-5.79	-1.61	-2.03
Polarization	Linear					
Impedance	50 Ohms					
Max Input Power	5 Watts					
MECHANICAL						
Dimension (mm)	80*50.5*11 (Antenna Main Body)					
Cable length	300mm					
Cable Type	Φ1.37 RF Coaxial Cable					
Connector	IPEX MHFHT					
Appearance	Black, Heat Shrink with Glue					
Gasket & Adhesive	3M 9448 + CR-4305					
Weight	32g					
ENVIRONMENTAL RATINGS						
Protection	IP65					
Storage Temperature Range	-40°C to +85°C					
Operation Temperature Range	-40°C to +85°C					
Humidity	Non-condensing 65°C 95% RH					

3. Antenna Characteristics

3.1 Return Loss

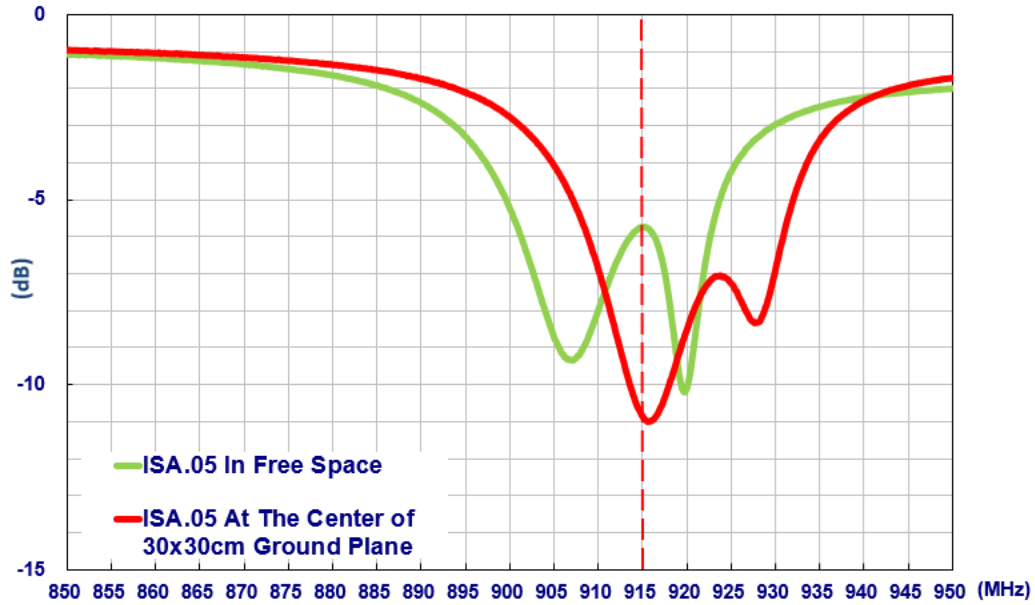

3.2 Average Gain

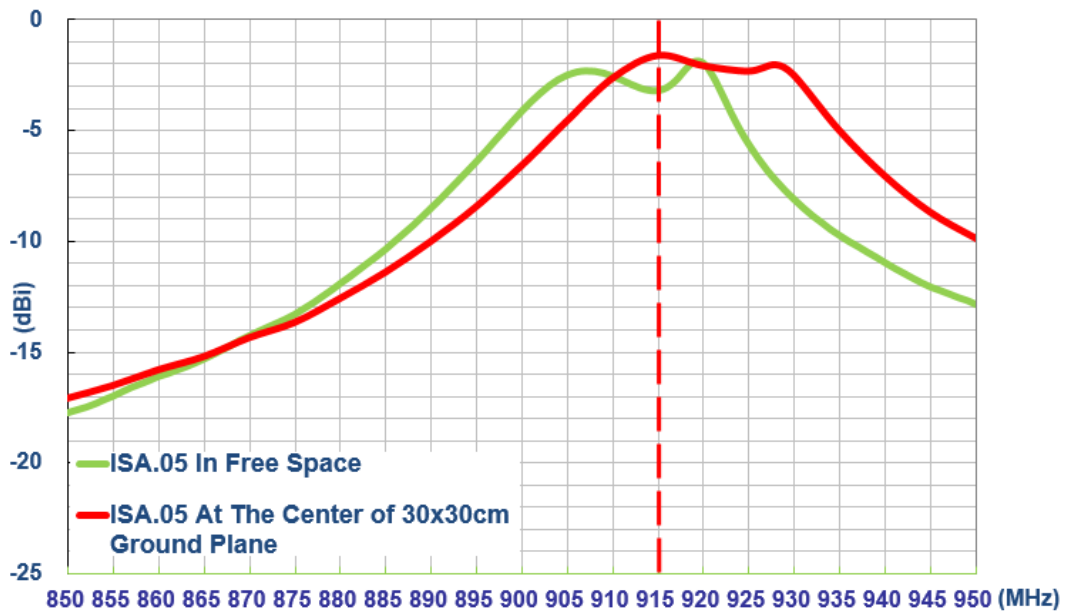

3.3 Efficiency

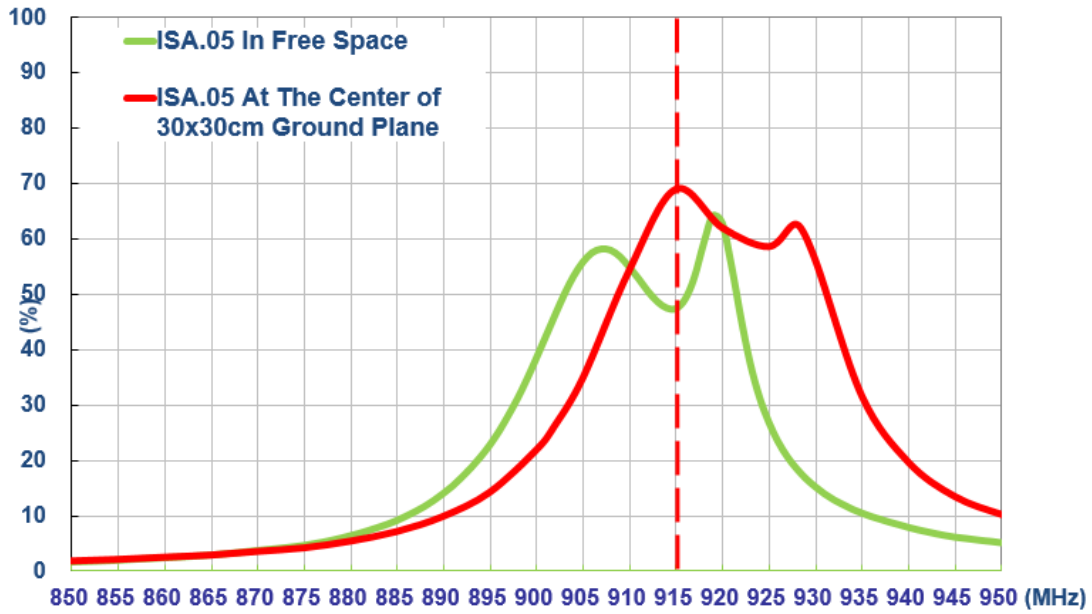

3.4 Peak Gain

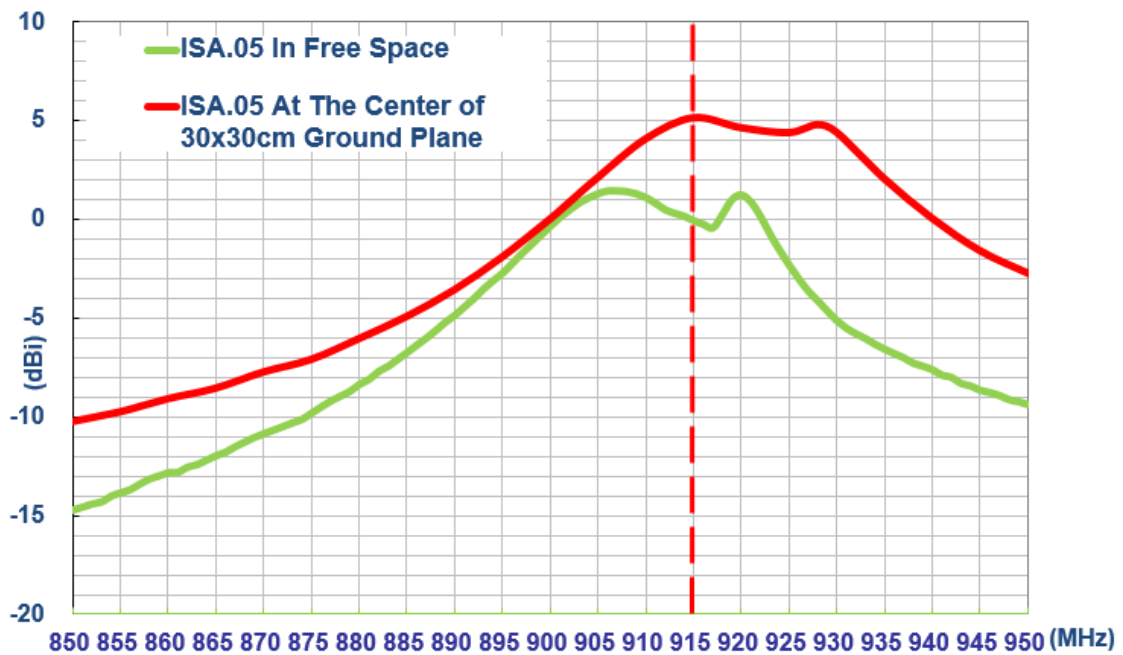

4. Antenna Radiation Patterns

4.1 Antenna Setup

The antenna radiation pattern measurement setup is shown below.

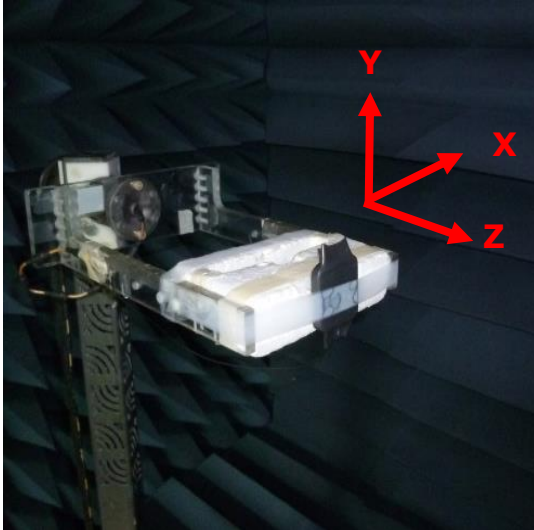

In free space

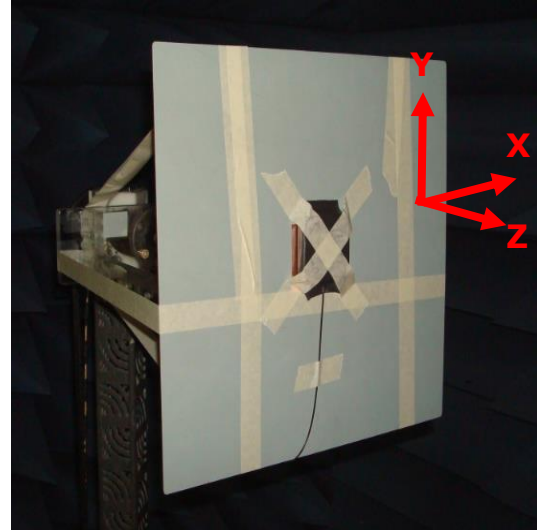

Center of 30cm*30cm Ground Plane

4.2 Antenna Radiation Patterns

4.2.1 In Free Space

XY Plane

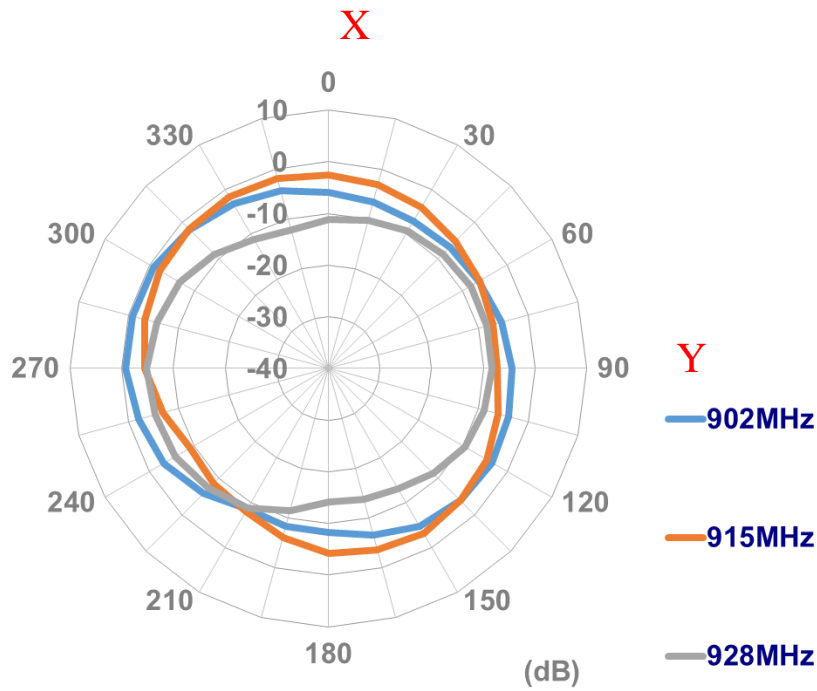

XZ Plane

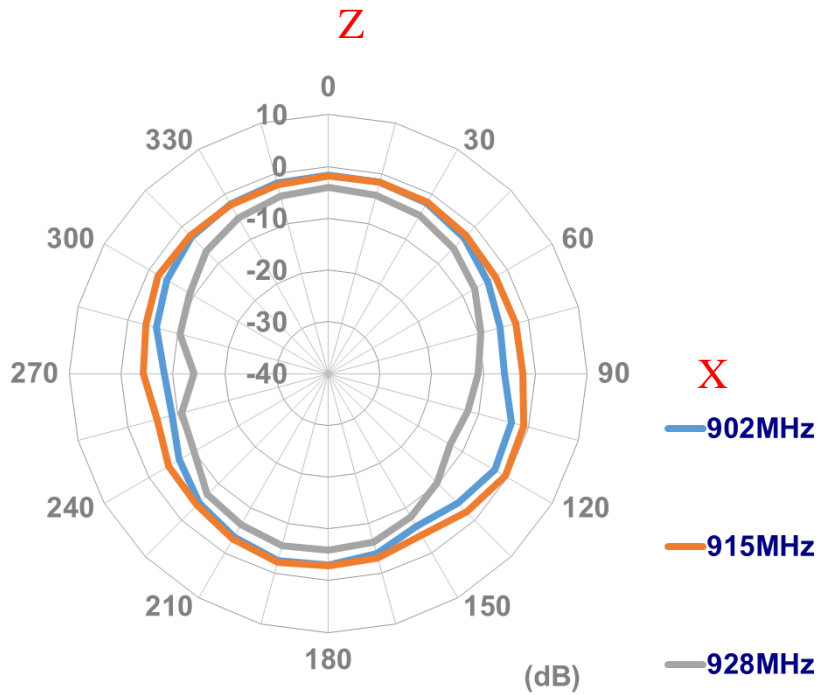

YZ Plane

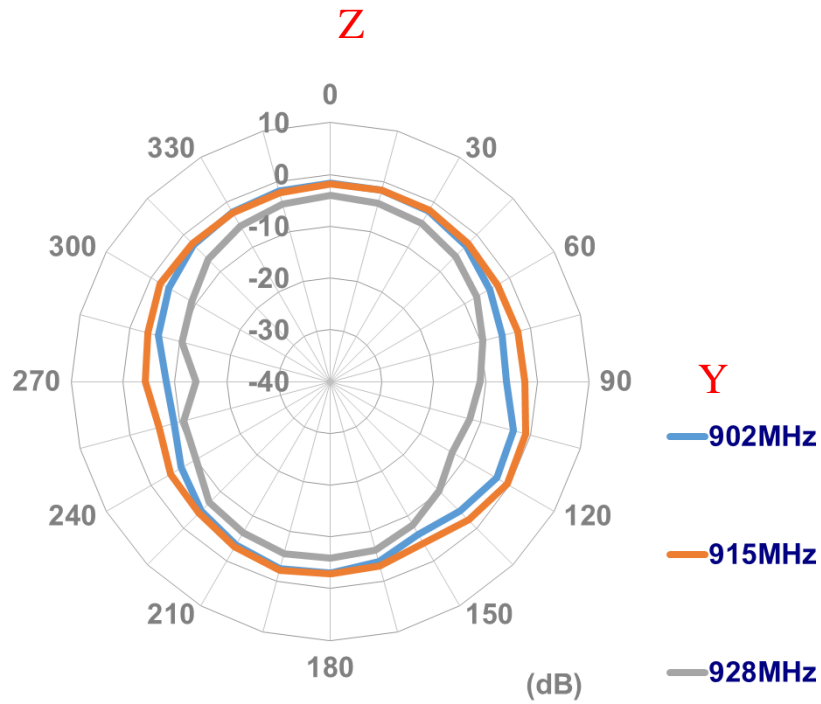

4.2.2 At the Center of 30cm*30cm Ground Plane

XY Plane

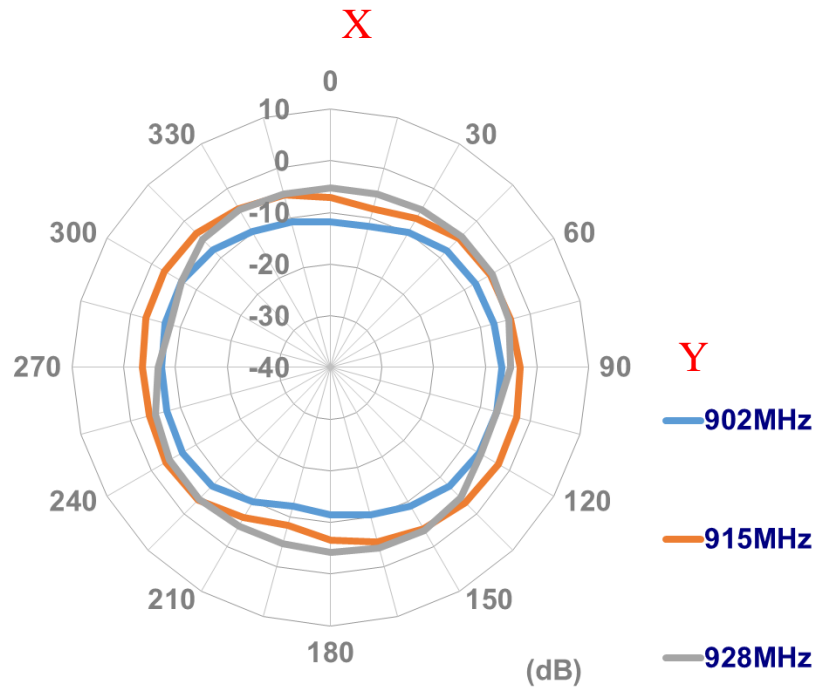

XZ Plane

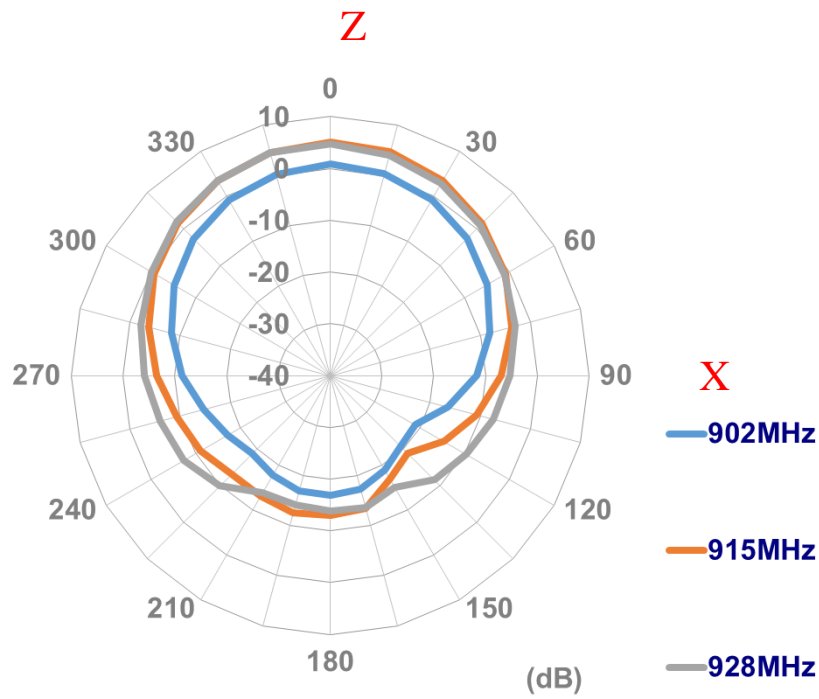

YZ Plane

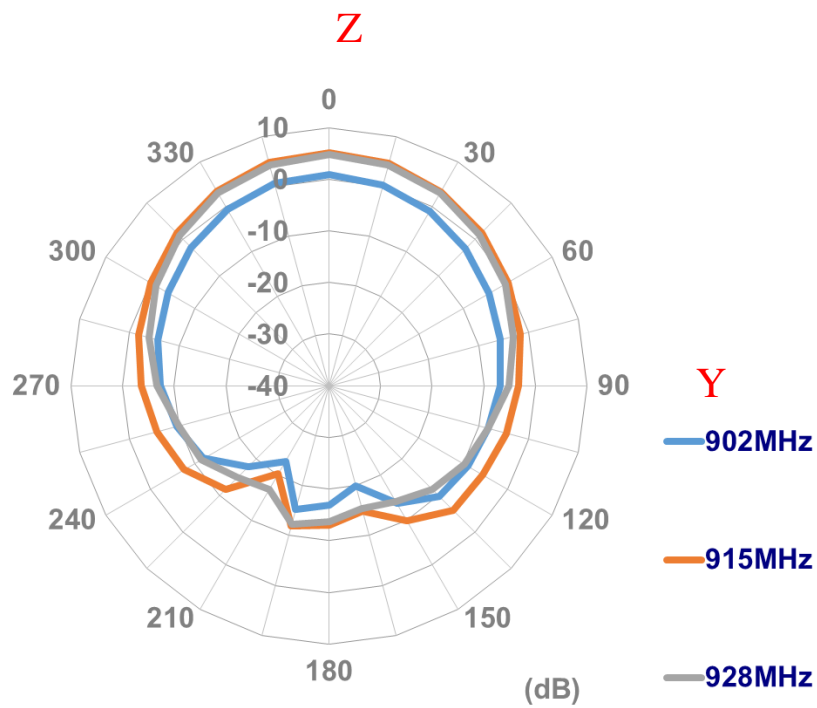

4.2.3 3D Radiation Pattern in Free Space

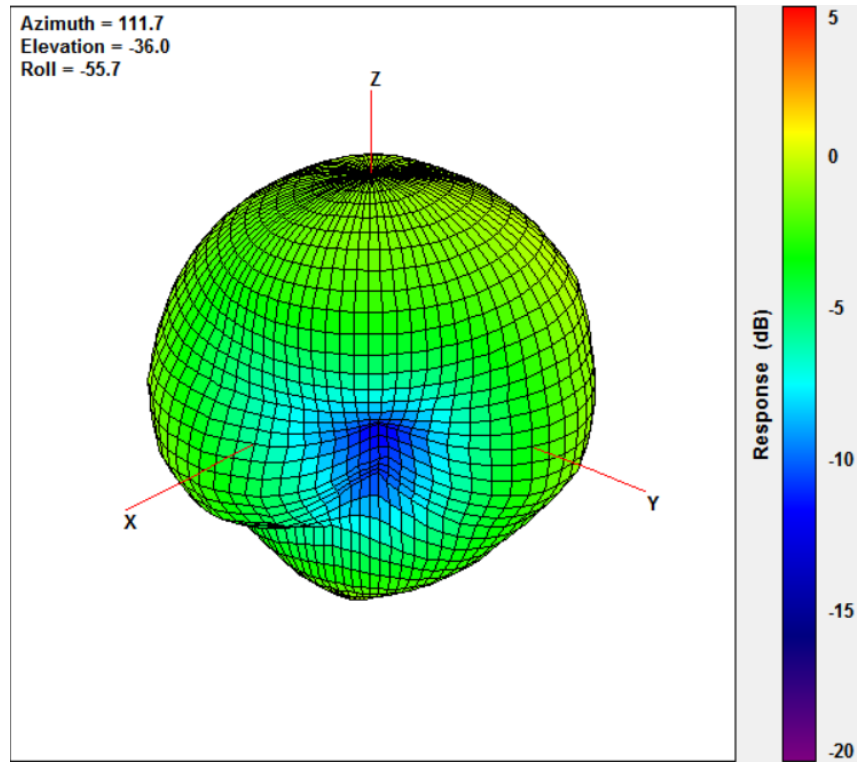

4.2.4 3D Radiation Pattern On 30cm*30cm Ground Plane

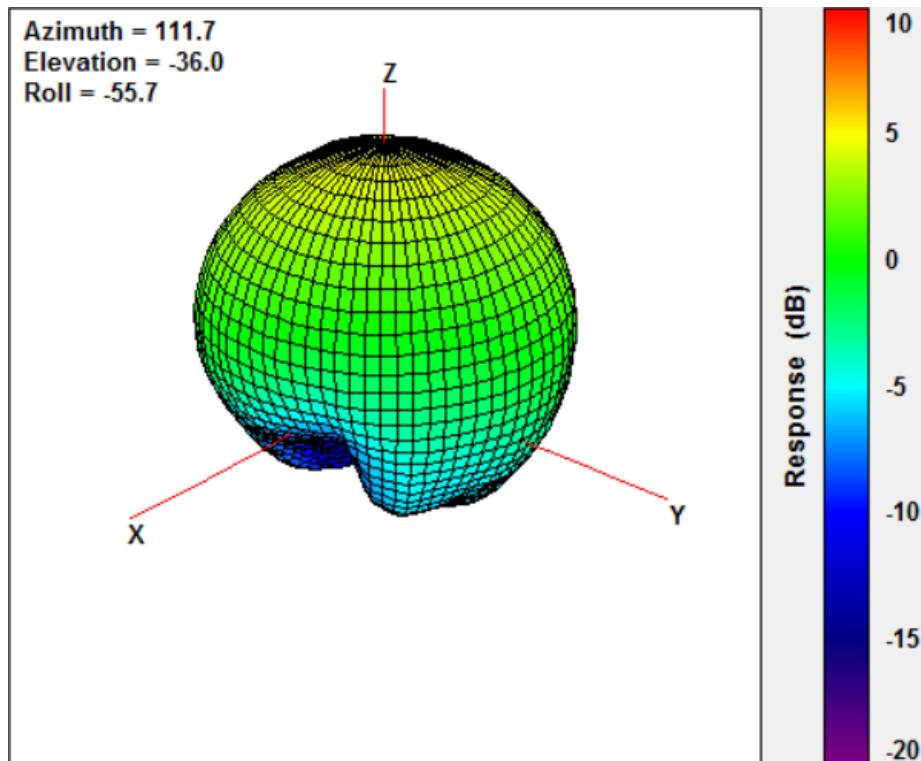



5. Drawing (Units: mm)

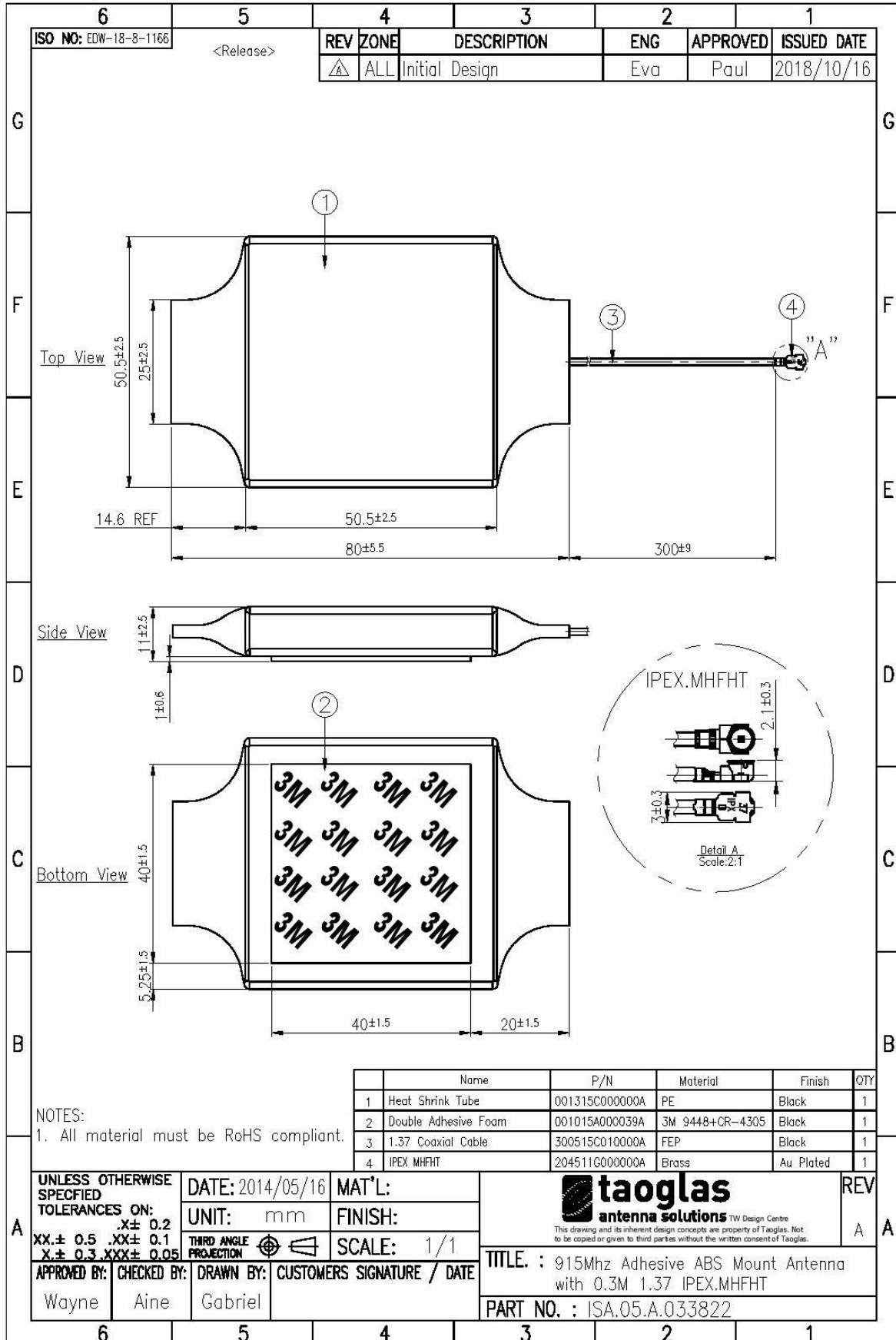

6. Packaging

48 ISA.05.A.033822 per tray
 Tray Dimensions - 410*410*35mm
 Total Weight - 3.5Kg

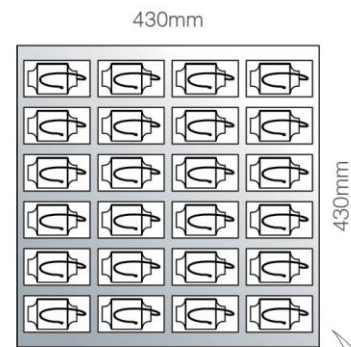

5 vacuum packed trays per carton
 240 ISA.05.A.033822 per carton
 Carton Dimensions - 430*430*175mm
 Weight - 17.7Kg

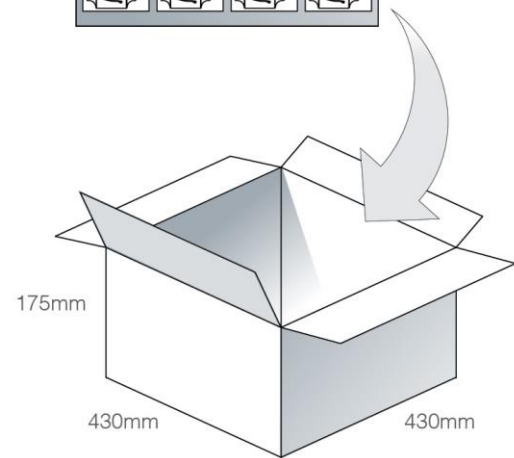

Pallet Dimensions 1100*1100*1500mm
 36 Cartons per pallet
 12 Cartons per layer
 4 Layers

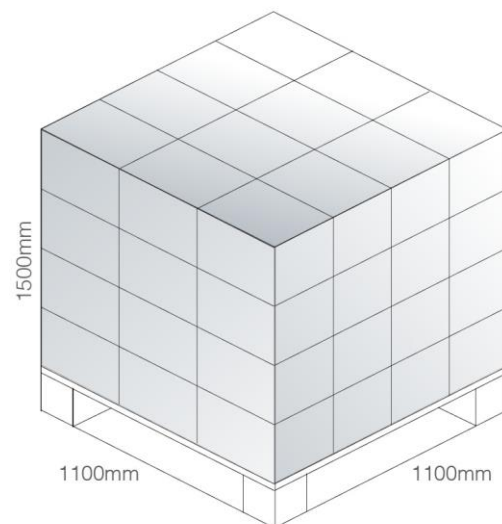

7. Installation

Plugs Usage Precautions

Mating / unmating

(1) To disconnect connectors, insert the end portion of I-PEX under the connector flanges and pull off vertically, in the direction of the connector mating axis.

(2) To mate the connectors, the mating axes of both connectors must be aligned and the connectors can be mated. The "click" will confirm fully mated connection.

Do not attempt to insert on an extreme angle.

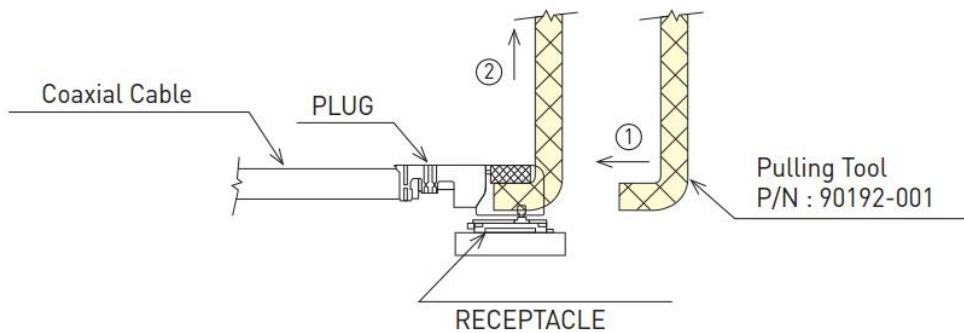

Pull forces on the cable after connectors are mated

After the connectors are mated, do not apply a load to the cable in excess of the values indicated in the diagram below.

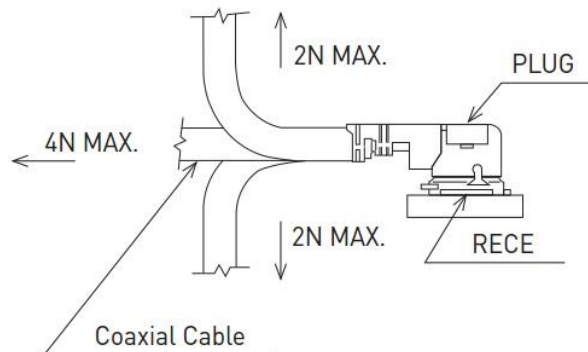

8. Application Note

8.1 Ground Size and proximity affects performance

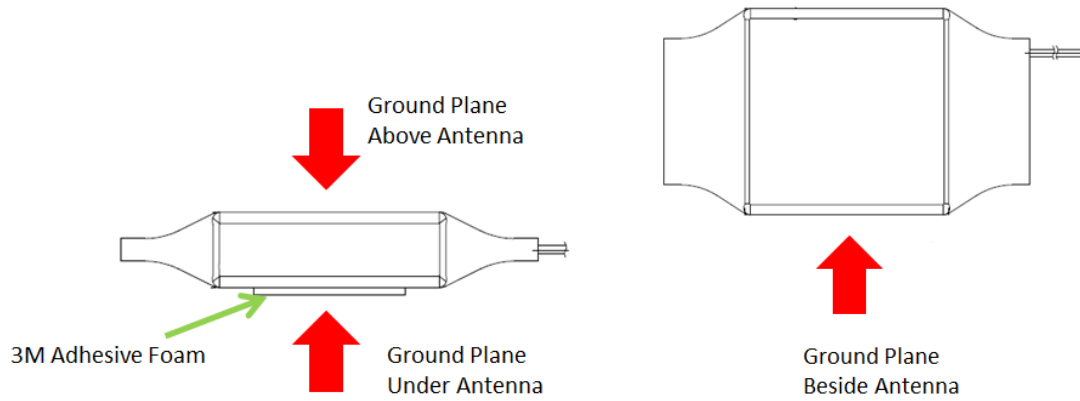

8.2 Ground Plane Beside Antenna Effect

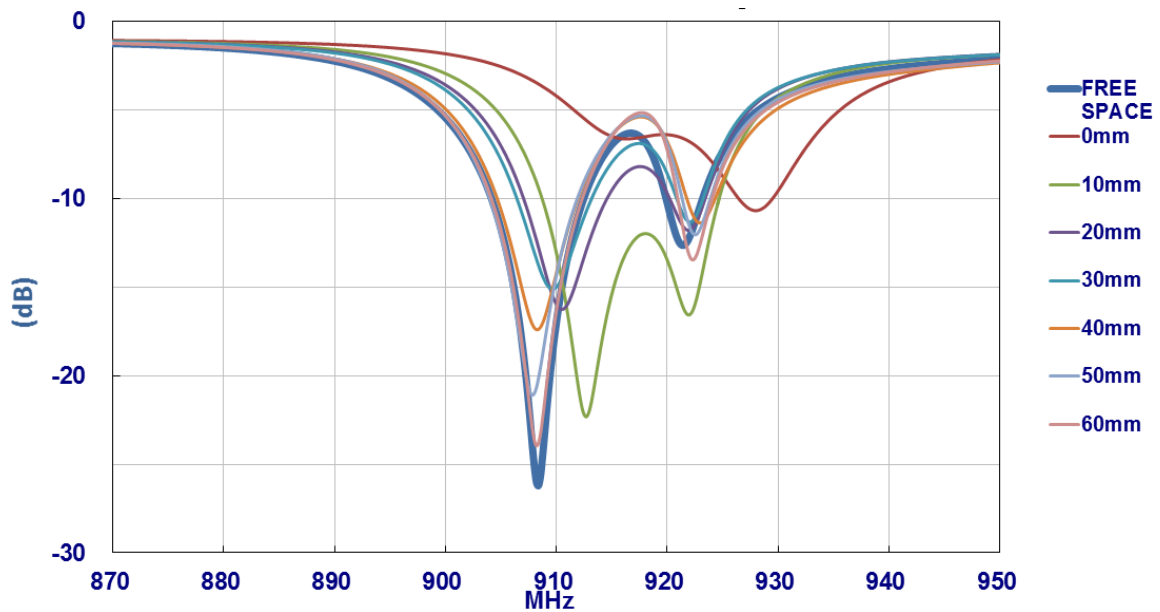

Any ground plane beside the antenna should be at least 10mm away from the antenna main body to keep antenna radiating normally.

8.3 Ground Plane Under Antenna Effect

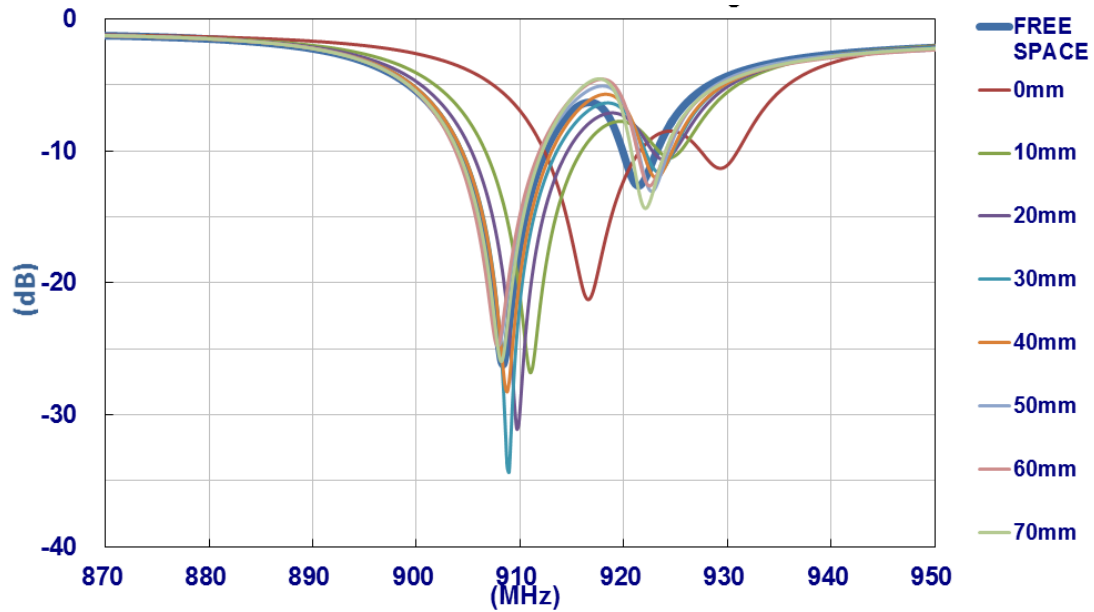

8.4 Ground Plane Above Antenna Effect

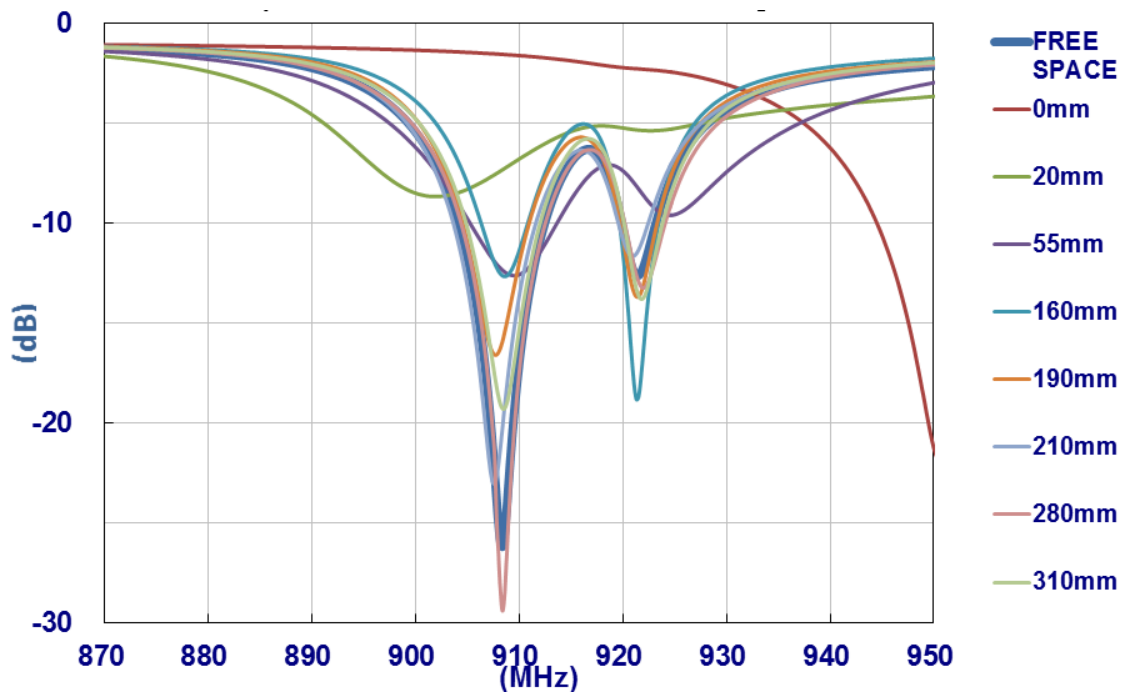

Any ground plane above the antenna should be at least 55mm away from the antenna main body to keep antenna radiating normally.