

ISL28113, ISL28213, ISL28413

Single, Dual, Quad General Purpose Micropower, RRIO Operational Amplifier

FN6728  
Rev 8.00  
April 8, 2015

The ISL28113, ISL28213 and ISL28413 are single, dual and quad channel general purpose micropower, rail-to-rail input and output operational amplifiers with supply voltage range of 1.8V to 5.5V. Key features are a low supply current of 130µA maximum per channel at room temperature, a low bias current and a wide input voltage range, which enables the ISL28x13 devices to be excellent general purpose operational amplifiers for a wide range of applications.

The ISL28113 is available in the SC70-5 and SOT23-5 packages, the ISL28213 is in the MSOP8, SOIC8, SOT23-8 packages and the ISL28413 is in the TSSOP14, SOIC14 packages. All devices operate across the extended temperature range of -40°C to +125°C.

**Related Literature**

- See [AN1519](#) for “ISL28213/14SOICEVAL2Z Evaluation Board User’s Guide”
- See [AN1520](#) for “ISL28113/14SOT23EVAL1Z Evaluation Board User’s Guide”
- See [AN1542](#) for “ISL28213/14MSOPEVAL2Z Evaluation Board User’s Guide”

**Features**

- Low current consumption ..... 130µA
- Wide supply range ..... 1.8V to 5.5V
- Gain bandwidth product ..... 2MHz
- Input bias current. .... 20pA, Max.
- Operating temperature range. .... -40°C to +125°C
- Packages
  - ISL28113 (Single) ..... SC70-5, SOT23-5
  - ISL28213 (Dual). .... MSOP8, SOIC8, SOT23-8
  - ISL28413 (Quad) ..... SOIC14, TSSOP14

**Applications**

- Power supply control/regulation
- Process control
- Signal gain/buffers
- Active filters
- Current shunt sensing
- Transimpedance amps

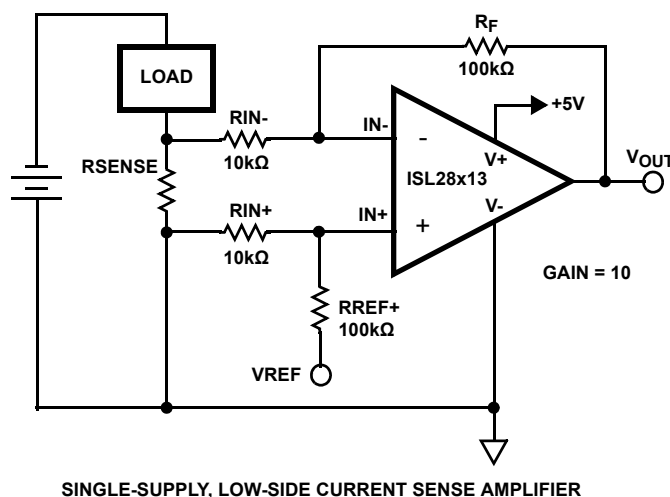

FIGURE 1. TYPICAL APPLICATION

## Ordering Information

| PART NUMBER<br>(Note 4)      | PART MARKING     | PACKAGE<br>(RoHS Compliant) | PKG. DWG. # |
|------------------------------|------------------|-----------------------------|-------------|
| ISL28113FEZ-T7 (Notes 1, 2)  | BJA (Note 5)     | 5 Ld SC-70                  | P5.049      |
| ISL28113FEZ-T7A (Notes 1, 2) | BJA (Note 5)     | 5 Ld SC-70                  | P5.049      |
| ISL28113FHZ-T7 (Notes 1, 2)  | BCYA (Note 5)    | 5 Ld SOT-23                 | P5.064A     |
| ISL28113FHZ-T7A (Notes 1, 2) | BCYA (Note 5)    | 5 Ld SOT-23                 | P5.064A     |
| ISL28213FUZ (Note 2)         | 8213Z            | 8 Ld MSOP                   | M8.118A     |
| ISL28213FUZ-T7 (Notes 1, 2)  | 8213Z            | 8 Ld MSOP                   | M8.118A     |
| ISL28213FBZ (Note 2)         | 28213 FBZ        | 8 Ld SOIC                   | M8.15E      |
| ISL28213FBZ-T7 (Notes 1, 2)  | 28213 FBZ        | 8 Ld SOIC                   | M8.15E      |
| ISL28213FBZ-T13 (Notes 1, 2) | 28213 FBZ        | 8 Ld SOIC                   | M8.15E      |
| ISL28213FHZ-T7 (Notes 1, 3)  | BEKA (Note 5)    | 8 Ld SOT-23                 | P8.064      |
| ISL28213FHZ-T7A (Notes 1, 3) | BEKA (Note 5)    | 8 Ld SOT-23                 | P8.064      |
| ISL28413FVZ (Note 2)         | 28413 FVZ        | 14 Ld TSSOP                 | MDP0044     |
| ISL28413FVZ-T7 (Notes 1, 2)  | 28413 FVZ        | 14 Ld TSSOP                 | MDP0044     |
| ISL28413FVZ-T13 (Notes 1, 2) | 28413 FVZ        | 14 Ld TSSOP                 | MDP0044     |
| ISL28413FBZ (Note 2)         | 28413 FBZ        | 14 Ld SOIC                  | MDP0027     |
| ISL28413FBZ-T7 (Notes 1, 2)  | 28413 FBZ        | 14 Ld SOIC                  | MDP0027     |
| ISL28413FBZ-T13 (Notes 1, 2) | 28413 FBZ        | 14 Ld SOIC                  | MDP0027     |
| ISL28113SOT23EVAL1Z          | Evaluation Board |                             |             |
| ISL28213MSOPEVAL2Z           | Evaluation Board |                             |             |
| ISL28213SOICEVAL2Z           | Evaluation Board |                             |             |

**NOTES:**

1. Please refer to [TB347](#) for details on reel specifications.
2. These Intersil Pb-free plastic packaged products employ special Pb-free material sets, molding compounds/die attach materials, and 100% matte tin plate plus anneal (e3 termination finish, which is RoHS compliant and compatible with both SnPb and Pb-free soldering operations). Intersil Pb-free products are MSL classified at Pb-free peak reflow temperatures that meet or exceed the Pb-free requirements of IPC/JEDEC J STD-020.
3. These Intersil Pb-free plastic packaged products employ special Pb-free material sets; molding compounds/die attach materials and NiPdAu plate - e4 termination finish, which is RoHS compliant and compatible with both SnPb and Pb-free soldering operations. Intersil Pb-free products are MSL classified at Pb-free peak reflow temperatures that meet or exceed the Pb-free requirements of IPC/JEDEC J STD-020.
4. For Moisture Sensitivity Level (MSL), please see device information page for [ISL28113](#), [ISL28213](#), [ISL28413](#). For more information on MSL please see Techbrief [TB363](#).
5. The part marking is located on the bottom of the part.

## Pin Configurations

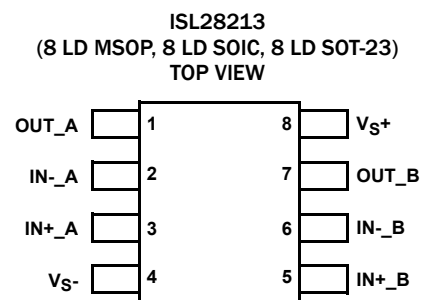
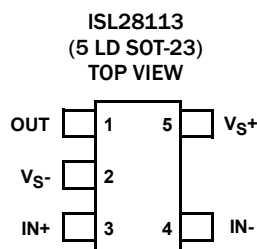
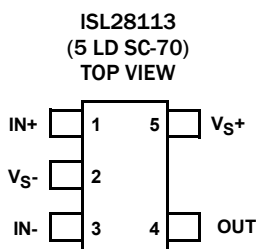

## Pin Configurations (Continued)

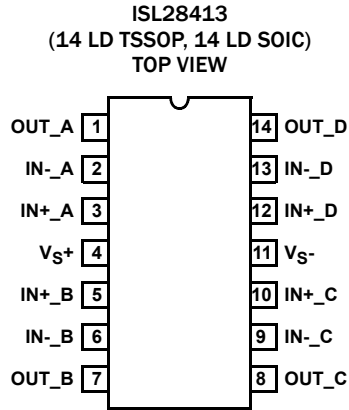

## Pin Descriptions

| PIN NAME | PIN NUMBER |             |                                   |                         | DESCRIPTION             |  |
|----------|------------|-------------|-----------------------------------|-------------------------|-------------------------|--|
|          | 5 LD SC-70 | 5 LD SOT-23 | 8 LD MSOP, 8 LD SOIC, 8 LD SOT-23 | 14 LD TSSOP, 14 LD SOIC |                         |  |
| OUT      | 4          | 1           |                                   |                         | Output                  | <p style="text-align: center;">CIRCUIT 1</p> |
| OUT_A    |            |             | 1                                 | 1                       |                         |  |
| OUT_B    |            |             | 7                                 | 7                       |                         |  |
| OUT_C    |            |             |                                   | 8                       |                         |  |
| OUT_D    |            |             |                                   | 14                      |                         |  |
| VS-      | 2          | 2           | 4                                 | 11                      | Negative supply voltage | <p style="text-align: center;">CIRCUIT 2</p> |
| IN+      | 1          | 3           |                                   |                         | Positive Input          | <p style="text-align: center;">CIRCUIT 3</p> |
| IN+_A    |            |             | 3                                 | 3                       |                         |  |
| IN+_B    |            |             | 5                                 | 5                       |                         |  |
| IN+_C    |            |             |                                   | 10                      |                         |  |
| IN+_D    |            |             |                                   | 12                      |                         |  |
| IN-      | 3          | 4           |                                   |                         | Negative Input          |  |
| IN_A     |            |             | 2                                 | 2                       |                         |  |
| IN_B     |            |             | 6                                 | 6                       |                         |  |
| IN_C     |            |             |                                   | 9                       |                         |  |
| IN_D     |            |             |                                   | 13                      |                         |  |
| VS+      | 5          | 5           | 8                                 | 4                       | Positive supply voltage | See "CIRCUIT 2"                              |

**Absolute Maximum Ratings** ( $T_A = +25^\circ\text{C}$ )

|                                  |  |
|----------------------------------|--|
| Supply Voltage                   | 6.5V                                       |
| Supply Turn-on Voltage Slew Rate | 1V/ $\mu\text{s}$                          |
| Differential Input Current       | 20mA                                       |
| Differential Input Voltage       | $V_- - 0.5\text{V}$ to $V_+ + 0.5\text{V}$ |
| Input Voltage                    | $V_- - 0.5\text{V}$ to $V_+ + 0.5\text{V}$ |
| ESD Rating                       |  |
| Human Body Model                 | 4000V                                      |
| Machine Model                    |  |
| ISL28113, ISL28213               | 350V                                       |
| ISL28413                         | 400V                                       |
| Charged Device Model             | 2000V                                      |

**Thermal Information**

|                                     |   |   |
|-------------------------------------|---|---|
| Thermal Resistance (Typical)        | $\theta_{JA}$ ( $^\circ\text{C}/\text{W}$ )   | $\theta_{JC}$ ( $^\circ\text{C}/\text{W}$ ) |
| 5 Ld SC-70 (Notes 6, 7)             | 250   | N/A   |
| 5 Ld SOT-23 (Notes 6, 7)            | 225   | N/A   |
| 8 Ld MSOP (Notes 6, 7)              | 180   | 100   |
| 8 Ld SOIC Package (Notes 6, 7)      | 126   | 90  |
| 8 Ld SOT-23 (Notes 6, 7)            | 240   | 168   |
| 14 Ld TSSOP Package (Notes 6, 7)    | 120   | 40  |
| 14 Ld SOIC Package (Notes 6, 7)     | 90  | 50  |
| Ambient Operating Temperature Range | -40 $^\circ\text{C}$ to +125 $^\circ\text{C}$ |   |
| Storage Temperature Range           | -65 $^\circ\text{C}$ to +150 $^\circ\text{C}$ |   |
| Operating Junction Temperature      | +125 $^\circ\text{C}$                         |   |
| Pb-free Reflow Profile              | see <a href="#">TB493</a>                     |   |

**CAUTION:** Do not operate at or near the maximum ratings listed for extended periods of time. Exposure to such conditions may adversely impact product reliability and result in failures not covered by warranty.

**NOTES:**

- $\theta_{JA}$  is measured with the component mounted on a high effective thermal conductivity test board in free air. See Tech Brief [TB379](#) for details.
- For  $\theta_{JC}$ , the "case temp" location is the top of the package.

**Electrical Specifications**  $V_{S+} = 5\text{V}$ ,  $V_{S-} = 0\text{V}$ ,  $R_L = \text{Open}$ ,  $V_{CM} = V_S/2$ ,  $T_A = +25^\circ\text{C}$ , unless otherwise specified. **Boldface limits apply across the operating temperature range, -40 $^\circ\text{C}$  to +125 $^\circ\text{C}$ , unless otherwise specified.**

| PARAMETER                       | DESCRIPTION                                  | TEST CONDITIONS                               | MIN<br>( <a href="#">Note 8</a> ) | TYP              | MAX<br>( <a href="#">Note 8</a> ) | UNIT                         |
|---------------------------------|--|---|-----------------------------------|------------------|-----------------------------------|------------------------------|
| <b>DC SPECIFICATIONS</b>        |  |   |                                   |                  |                                   |                              |
| $V_{OS}$                        | Input Offset Voltage                         |   | -4                                | 0.5              | 4                                 | mV                           |
|                                 |  |   | <b>-5</b>                         |                  | <b>5</b>                          | mV                           |
| $TCV_{OS}$                      | Input Offset Voltage Temperature Coefficient | -40 $^\circ\text{C}$ to +125 $^\circ\text{C}$ |                                   | <b>5</b>         |                                   | $\mu\text{V}/^\circ\text{C}$ |
| $I_{OS}$                        | Input Offset Current                         |   |                                   | 1                | 30                                | $\mu\text{A}$                |
| $I_B$                           | Input Bias Current                           | ISL28113                                      | -20                               | 3                | 20                                | $\mu\text{A}$                |
|                                 |  |   | <b>-100</b>                       |                  | <b>100</b>                        | $\mu\text{A}$                |
|                                 |  | ISL28213, ISL28413                            | -20                               | 3                | 20                                | $\mu\text{A}$                |
|                                 |  |   | <b>-50</b>                        |                  | <b>50</b>                         | $\mu\text{A}$                |
| Common Mode Input Voltage Range |  |   | <b>-0.1V</b>                      |                  | <b>+5.1V</b>                      | V                            |
| $Z_{IN}$                        | Input Impedance                              |   |                                   | 10 <sup>12</sup> |                                   | $\Omega$                     |
| $C_{IN}$                        | Input Capacitance                            |   |                                   | 1                |                                   | pF                           |
| CMRR                            | Common Mode Rejection Ratio                  | $V_{CM} = -0.1\text{V}$ to $5.1\text{V}$      |                                   | 72               |                                   | dB                           |
|                                 |  | -40 $^\circ\text{C}$ to +125 $^\circ\text{C}$ |                                   | 70               |                                   | dB                           |
| PSRR                            | Power Supply Rejection Ratio                 | $V_S = 1.8\text{V}$ to $5.5\text{V}$          |                                   | 71               |                                   | dB                           |
|                                 |  | -40 $^\circ\text{C}$ to +125 $^\circ\text{C}$ |                                   | 70               |                                   | dB                           |
| $V_{OH}$                        | Output Voltage Swing, High                   | $R_L = 10\text{k}\Omega$                      | 4.985                             | 4.993            |                                   | V                            |
|                                 |  |   | <b>4.98</b>                       |                  |                                   | V                            |
| $V_{OL}$                        | Output Voltage Swing, Low                    | $R_L = 10\text{k}\Omega$                      |                                   | 13               | 15                                | mV                           |
|                                 |  |   |                                   |                  | <b>20</b>                         | mV                           |
| $V_+$                           | Supply Voltage                               |   | 1.8                               |                  | 5.5                               | V                            |
| $I_S$                           | Supply Current per Amplifier                 | $R_L = \text{OPEN}$                           |                                   | 90               | 130                               | $\mu\text{A}$                |
|                                 |  |   |                                   |                  | <b>170</b>                        | $\mu\text{A}$                |

**Electrical Specifications**  $V_{S+} = 5V$ ,  $V_{S-} = 0V$ ,  $R_L = \text{Open}$ ,  $V_{CM} = V_S/2$ ,  $T_A = +25^\circ\text{C}$ , unless otherwise specified. **Boldface limits apply across the operating temperature range,  $-40^\circ\text{C}$  to  $+125^\circ\text{C}$** , unless otherwise specified. (Continued)

| PARAMETER                    | DESCRIPTION                            | TEST CONDITIONS   | MIN<br>(Note 8) | TYP | MAX<br>(Note 8) | UNIT                         |
|------------------------------|--|---|-----------------|-----|-----------------|------------------------------|
| $I_{SC+}$                    | Output Source Short Circuit Current    | $R_L = 10\Omega$ to V-  |                 | -22 |                 | mA                           |
| $I_{SC-}$                    | Output Sink Short Circuit Current      | $R_L = 10\Omega$ to V+  |                 | 16  |                 | mA                           |
| <b>AC SPECIFICATIONS</b>     |  |   |                 |     |                 |                              |
| GBWP                         | Gain Bandwidth Product                 | $V_S = \pm 2.5V$<br>$A_V = 100$ , $R_F = 100k\Omega$ ,<br>$R_G = 1k\Omega$ , $R_L = 10k\Omega$ to $V_{CM}$              |                 | 2   |                 | MHz                          |
| $e_{N\ V_{P-P}}$             | Peak-to-Peak Input Noise Voltage       | $V_S = \pm 2.5V$<br>$f = 0.1\text{Hz}$ to $10\text{Hz}$   |                 | 14  |                 | $\mu\text{V}_{P-P}$          |
| $e_N$                        | Input Noise Voltage Density            | $V_S = \pm 2.5V$<br>$f = 1\text{kHz}$   |                 | 55  |                 | $\text{nV}/\sqrt{\text{Hz}}$ |
|                              |  | $V_S = \pm 2.5V$<br>$f = 10\text{kHz}$  |                 | 29  |                 | $\text{nV}/\sqrt{\text{Hz}}$ |
| $i_N$                        | Input Noise Current Density            | $V_S = \pm 2.5V$<br>$f = 1\text{kHz}$   |                 | 5   |                 | $\text{fA}/\sqrt{\text{Hz}}$ |
| $C_{in}$                     | Differential Input Capacitance         | $V_S = \pm 2.5V$<br>$f = 1\text{MHz}$   |                 | 1.0 |                 | pF                           |
|                              | Common Mode Input Capacitance          |   |                 | 1.3 |                 | pF                           |
| <b>TRANSIENT RESPONSE</b>    |  |   |                 |     |                 |                              |
| SR                           | Slew Rate 20% to 80% $V_{OUT}$         | $V_{OUT} = 0.5V$ to $4.5V$  |                 | 1   |                 | $\text{V}/\mu\text{s}$       |
| $t_r$ , $t_f$ , Small Signal | Rise Time, $t_r$ 10% to 90%            | $V_S = \pm 2.5V$<br>$A_V = +1$ , $V_{OUT} = 0.05V_{P-P}$ ,<br>$R_F = 0\Omega$ , $R_L = 10k\Omega$ , $C_L = 15\text{pF}$ |                 | 100 |                 | ns                           |
|                              | Fall Time, $t_f$ 10% to 90%            |   |                 | 115 |                 | ns                           |
| $t_s$                        | Settling Time to 0.1%, $4V_{P-P}$ Step | $V_S = \pm 2.5V$<br>$A_V = +1$ , $R_F = 0\Omega$ , $R_L = 10k\Omega$ ,<br>$C_L = 1.2\text{pF}$                          |                 | 7.5 |                 | $\mu\text{s}$                |

## NOTE:

8. Compliance to datasheet limits is assured by one or more methods: production test, characterization and/or design.

# Typical Performance Curves $V_S = \pm 2.5V, V_{CM} = 0V, R_L = \text{Open}$ , unless otherwise specified.

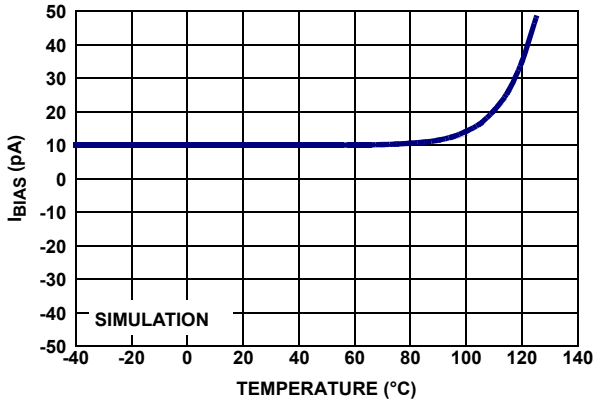

FIGURE 2. INPUT BIAS CURRENT vs TEMPERATURE

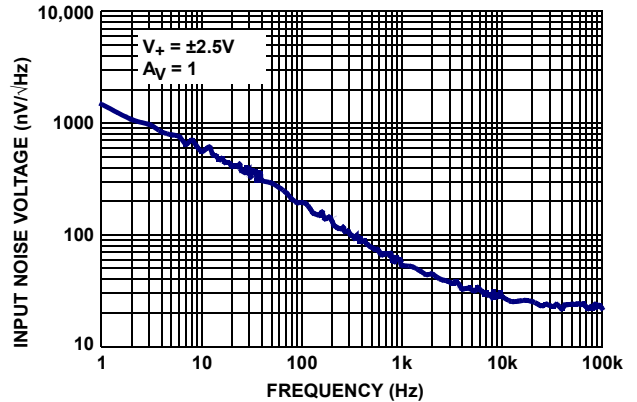

FIGURE 3. INPUT NOISE VOLTAGE SPECTRAL DENSITY

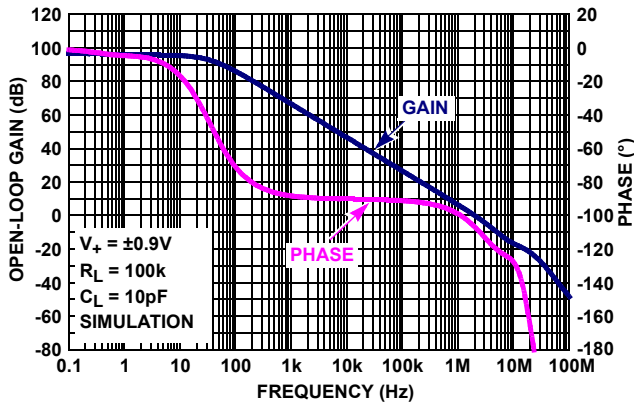

FIGURE 4. OPEN-LOOP GAIN, PHASE vs FREQUENCY,  $R_L = 100k\Omega$ ,  $C_L = 10pF$ ,  $V_S = \pm 0.9V$

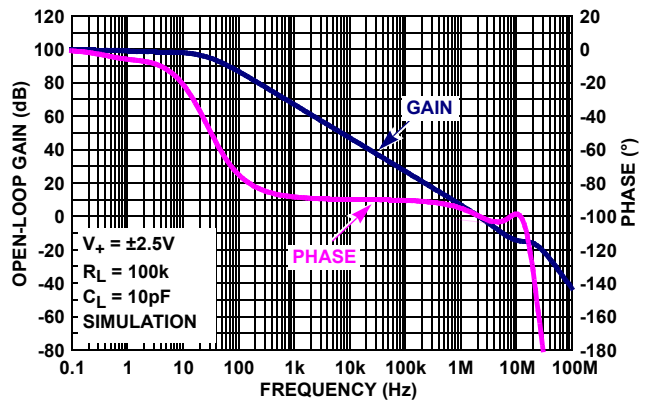

FIGURE 5. OPEN-LOOP GAIN, PHASE vs FREQUENCY,  $R_L = 100k\Omega$ ,  $C_L = 10pF$ ,  $V_S = \pm 2.5V$

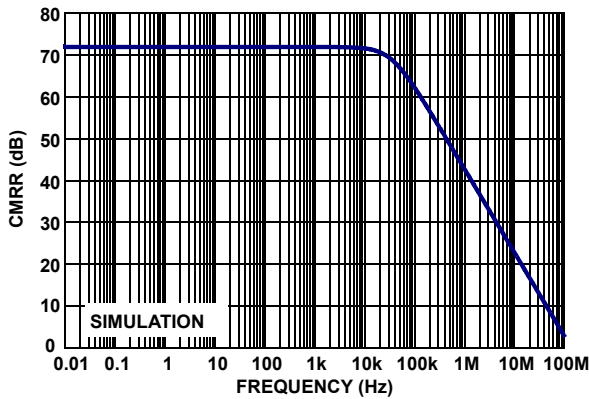

FIGURE 6. CMRR vs FREQUENCY,  $V_S = \pm 2.5$

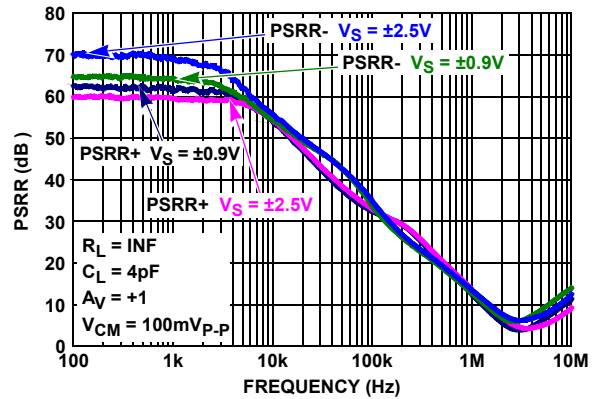

FIGURE 7. PSRR vs FREQUENCY,  $V_S = \pm 0.9V, \pm 2.5V$

**Typical Performance Curves**  $V_S = \pm 2.5V, V_{CM} = 0V, R_L = \text{Open}$ , unless otherwise specified. (Continued)

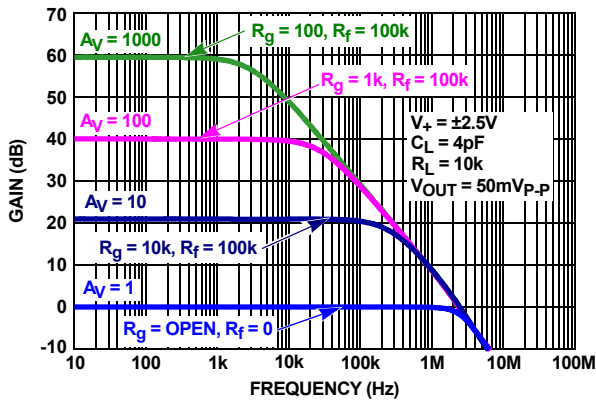

FIGURE 8. FREQUENCY RESPONSE vs CLOSED LOOP GAIN

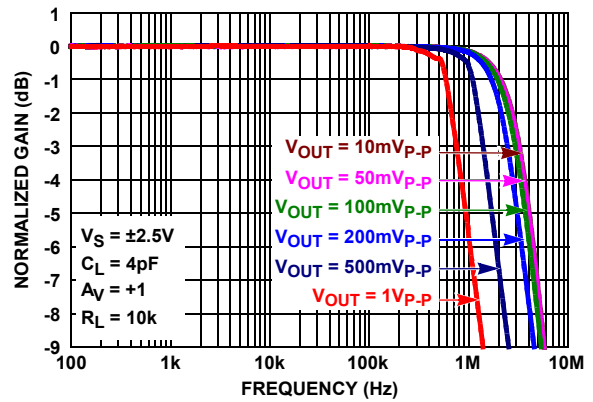

FIGURE 9. FREQUENCY RESPONSE vs  $V_{OUT}$

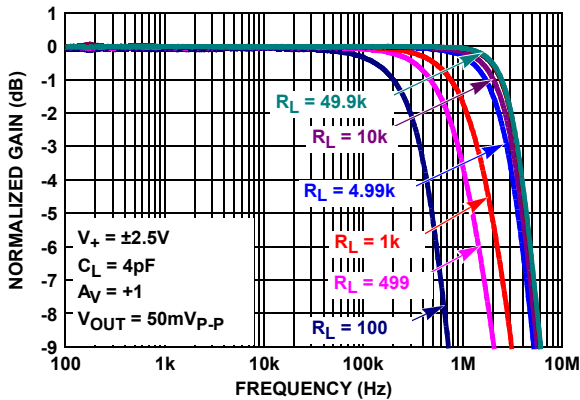

FIGURE 10. GAIN vs FREQUENCY vs  $R_L$

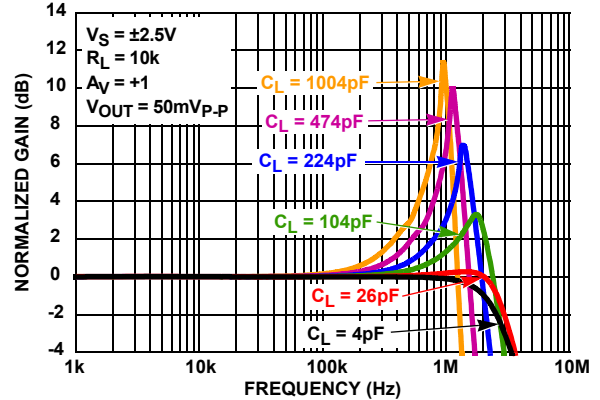

FIGURE 11. GAIN vs FREQUENCY vs  $C_L$

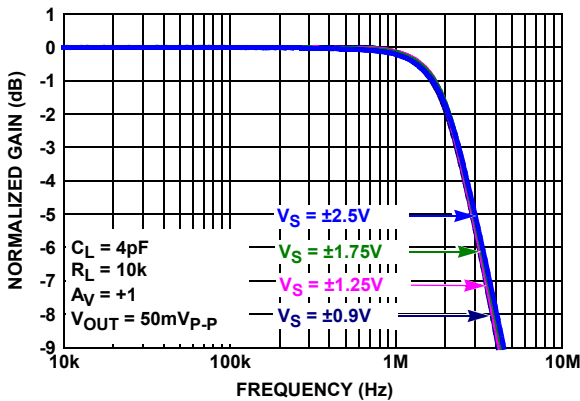

FIGURE 12. GAIN vs FREQUENCY vs SUPPLY VOLTAGE

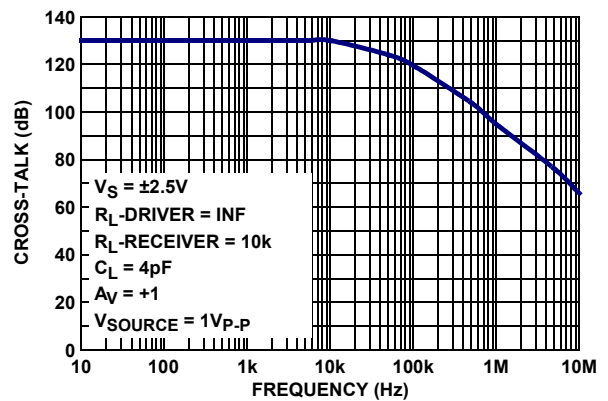

FIGURE 13. CROSSTALK,  $V_S = \pm 2.5V$

**Typical Performance Curves**  $V_S = \pm 2.5V, V_{CM} = 0V, R_L = \text{Open}$ , unless otherwise specified. (Continued)

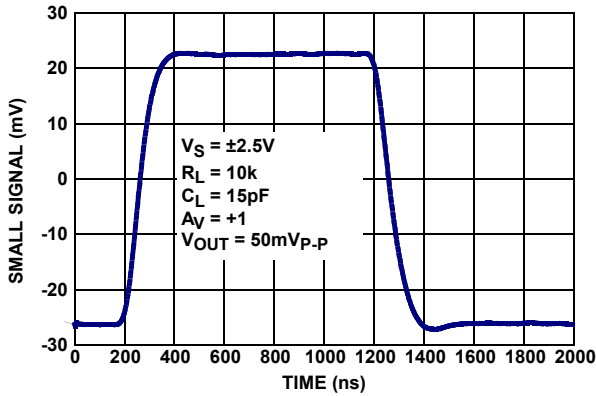

FIGURE 14. SMALL SIGNAL TRANSIENT RESPONSE,  $V_S = \pm 2.5V$

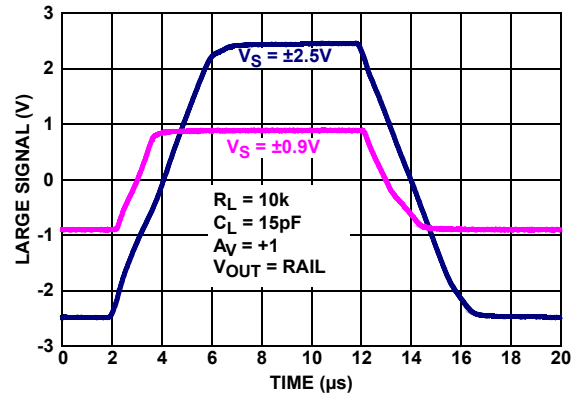

FIGURE 15. LARGE SIGNAL TRANSIENT RESPONSE vs  $R_L, V_S = \pm 0.9V, \pm 2.5V$

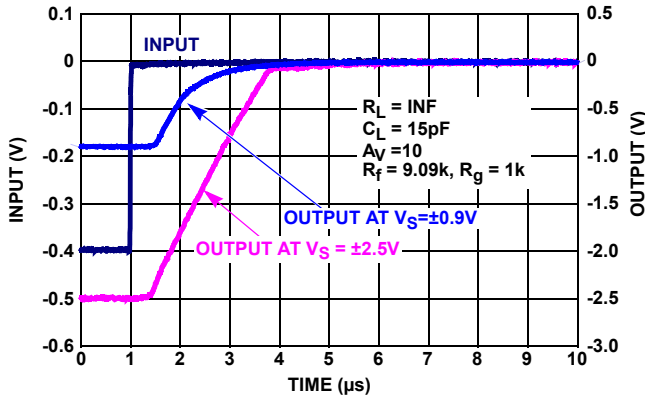

FIGURE 16. NEGATIVE OUTPUT OVERLOAD RESPONSE TIME,  $V_S = \pm 0.9V, \pm 2.5V$

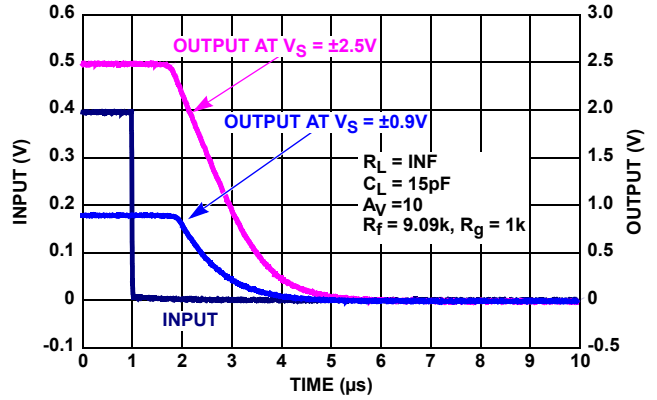

FIGURE 17. POSITIVE OUTPUT OVERLOAD RESPONSE TIME,  $V_S = \pm 0.9V, \pm 2.5V$

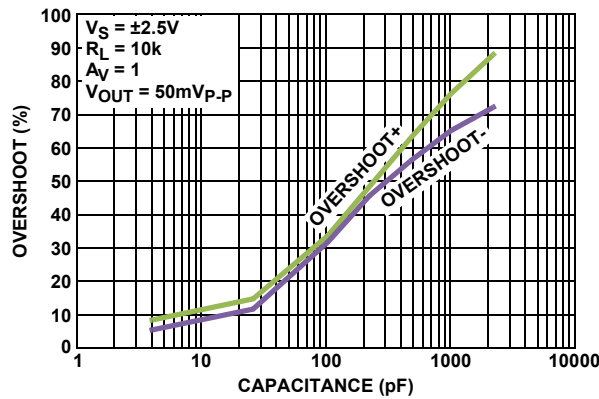

FIGURE 18. % OVERSHOOT vs LOAD CAPACITANCE,  $V_S = \pm 2.5V$



## Applications Information

### Functional Description

The ISL28113, ISL28213 and ISL28413 are single, dual and quad, CMOS rail-to-rail input, output (RRIO) micropower operational amplifiers. They are designed to operate from single supply (1.8V to 5.5V) or dual supply ( $\pm 0.9V$  to  $\pm 2.75V$ ). The parts have an input common mode range that extends 100mV above and below the power supply voltage rails. The output stage can swing to within 15mV of the supply rails with a 10k $\Omega$  load.

### Input ESD Diode Protection

All input terminals have internal ESD protection diodes to both positive and negative supply rails, limiting the input voltage to within one diode beyond the supply rails (see “Pin Descriptions - Circuit 1” on [page 3](#)). For applications where the input voltage may exceed either power supply voltage by 0.5V or more, an external series resistor must be used to ensure the input currents never exceed 20mA (see [Figure 19](#)).

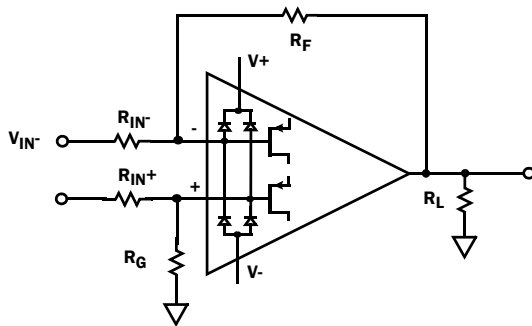

FIGURE 19. INPUT ESD DIODE CURRENT LIMITING

### Output Phase Reversal

Output phase reversal is a change of polarity in the amplifier transfer function when the input voltage exceeds the supply voltage. The ISL28113, ISL28213 and ISL28413 are immune to output phase reversal, even when the input voltage is 1V beyond the supplies.

### Unused Channels

If the application requires less than all amplifiers one channel, the user must configure the unused channel(s) to prevent it from oscillating. The unused channel(s) will oscillate if the input and output pins are floating. This will result in higher than expected supply currents and possible noise injection into the channel being used. The proper way to prevent this oscillation is to short the output to the inverting input and ground the positive input (as shown in [Figure 20](#)).

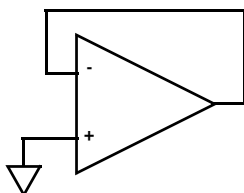

FIGURE 20. PREVENTING OSCILLATIONS IN UNUSED CHANNELS

### Power Dissipation

It is possible to exceed the +125°C maximum junction temperatures under certain load, power supply conditions and ambient temperature conditions. It is therefore important to calculate the maximum junction temperature ( $T_{JMAX}$ ) for all applications to determine if power supply voltages, load conditions, or package type need to be modified to remain in the safe operating area. These parameters are related using [Equation 1](#):

$$T_{JMAX} = T_{MAX} + \theta_{JA} \times PD_{MAXTOTAL} \quad (EQ. 1)$$

Where:

- $PD_{MAXTOTAL}$  is the sum of the maximum power dissipation of each amplifier in the package ( $PD_{MAX}$ )
- $PD_{MAX}$  for each amplifier can be calculated using [Equation 2](#):

$$PD_{MAX} = V_S \times I_{qMAX} + (V_S - V_{OUTMAX}) \times \frac{V_{OUTMAX}}{R_L} \quad (EQ. 2)$$

Where:

- $T_{MAX}$  = Maximum ambient temperature
- $\theta_{JA}$  = Thermal resistance of the package
- $PD_{MAX}$  = Maximum power dissipation of 1 amplifier
- $V_S$  = Total supply voltage
- $I_{qMAX}$  = Maximum quiescent supply current of 1 amplifier
- $V_{OUTMAX}$  = Maximum output voltage swing of the application
- $R_L$  = Load resistance

### ISL28113, ISL28213 and ISL28413 SPICE Model

[Figure 21](#) shows the SPICE model schematic and [Figure 22](#) shows the net list for the SPICE model. The model is a simplified version of the actual device and simulates important AC and DC parameters. AC parameters incorporated into the model are: 1/f and flatband noise, Slew Rate, CMRR, Gain and Phase. The DC parameters are IOS, total supply current and output voltage swing. The model uses typical parameters given in the “Electrical Specifications” Table beginning on [page 4](#). The AVOL is adjusted for 85dB with the dominate pole at 100Hz. The CMRR is set 72dB,  $f = 35kHz$ . The input stage models the actual device to present an accurate AC representation. The model is configured for ambient temperature of +25°C.

[Figures 23](#) through [32](#) show the characterization vs simulation results for the Noise Voltage, Closed Loop Gain vs Frequency, Large Signal 5V Step Response, CMRR and Open-loop Gain Phase.

## **LICENSE STATEMENT**

The information in this SPICE model is protected under the United States copyright laws. Intersil Corporation hereby grants users of this macromodel hereto referred to as "Licensee", a nonexclusive, nontransferable license to use this model as long as the Licensee abides by the terms of this agreement. Before using this macro-model, the Licensee should read this license. If the Licensee does not accept these terms, permission to use the model is not granted.

The Licensee may not sell, loan, rent, or license the macro-model, in whole, in part, or in modified form, to anyone outside the Licensee's company. The Licensee may modify the macro-model to suit his/her specific applications, and the Licensee may make copies of this macro-model for use within their company only.

This macro-model is provided "AS IS, WHERE IS, AND WITH NO WARRANTY OF ANY KIND EITHER EXPRESSED OR IMPLIED, INCLUDING, BUT NOT LIMITED TO, ANY IMPLIED WARRANTIES OF MERCHANTABILITY AND FITNESS FOR A PARTICULAR PURPOSE."

In no event will Intersil be liable for special, collateral, incidental, or consequential damages in connection with or arising out of the use of this macro-model. Intersil reserves the right to make changes to the product and the macro-model without prior notice.

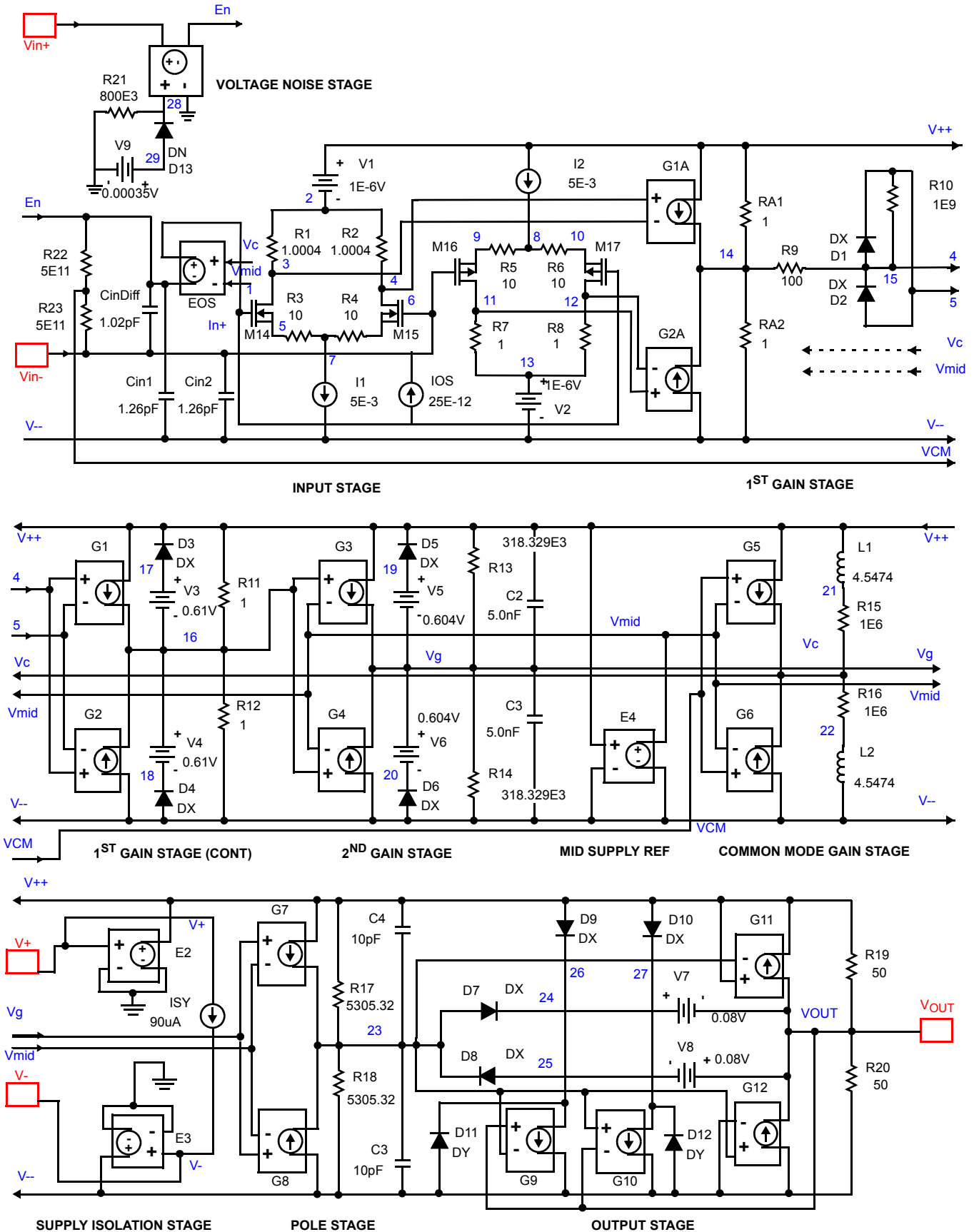

FIGURE 21. SPICE SCHEMATIC



## Characterization vs Simulation Results

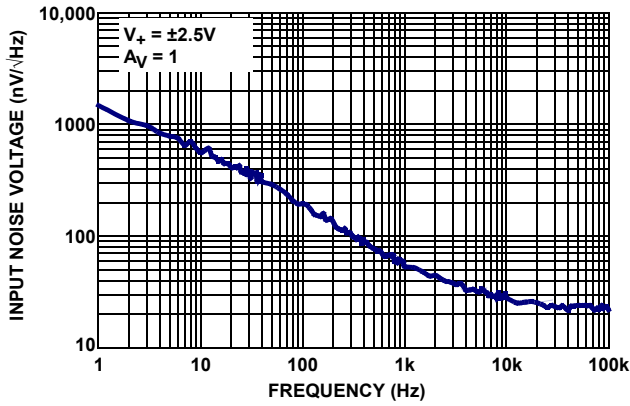

FIGURE 23. CHARACTERIZED INPUT NOISE VOLTAGE

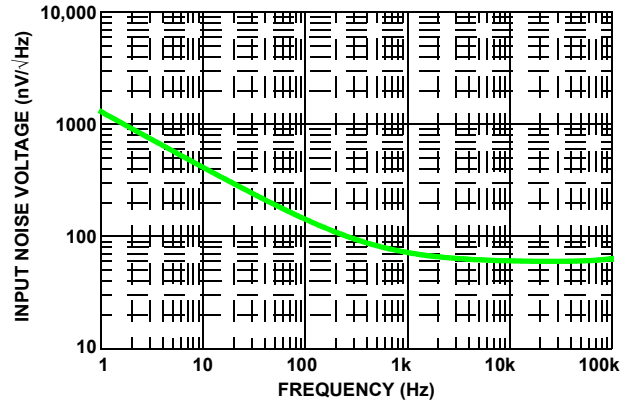

FIGURE 24. SIMULATED INPUT NOISE VOLTAGE

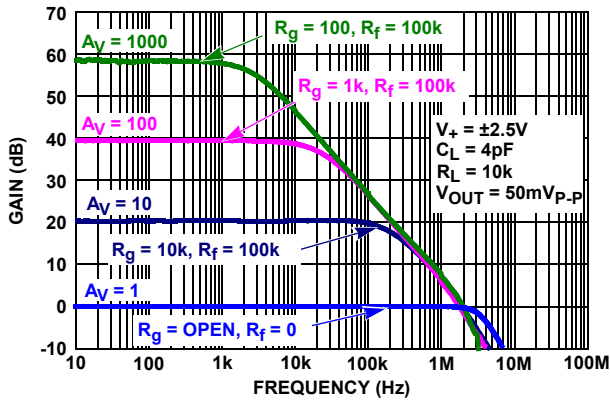

FIGURE 25. CHARACTERIZED CLOSED LOOP GAIN vs FREQUENCY

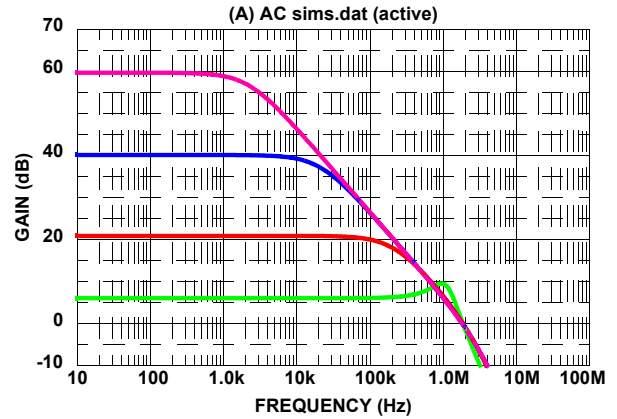

FIGURE 26. SIMULATED CLOSED LOOP GAIN vs FREQUENCY

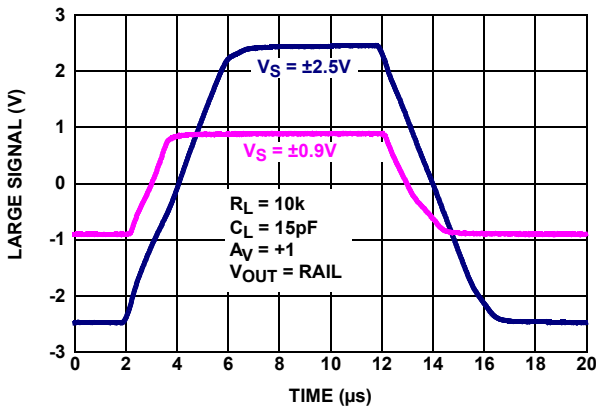

FIGURE 27. CHARACTERIZED LARGE SIGNAL TRANSIENT RESPONSE vs  $R_L$ ,  $V_S = \pm 0.9V, \pm 2.5V$

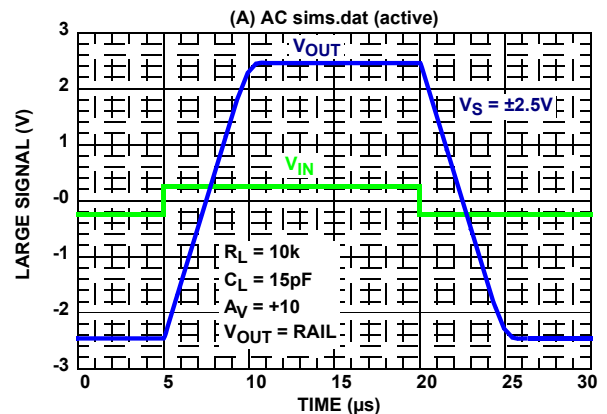

FIGURE 28. SIMULATED LARGE SIGNAL TRANSIENT RESPONSE vs  $R_L$ ,  $V_S = \pm 0.9V, \pm 2.5V$

## Characterization vs Simulation Results (Continued)

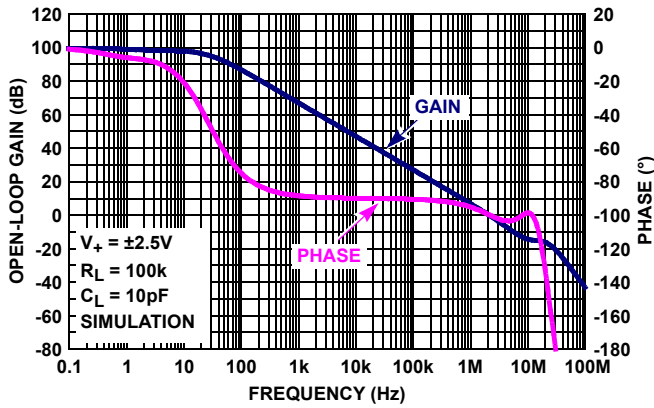

FIGURE 29. SIMULATED (DESIGN) OPEN-LOOP GAIN, PHASE vs FREQUENCY

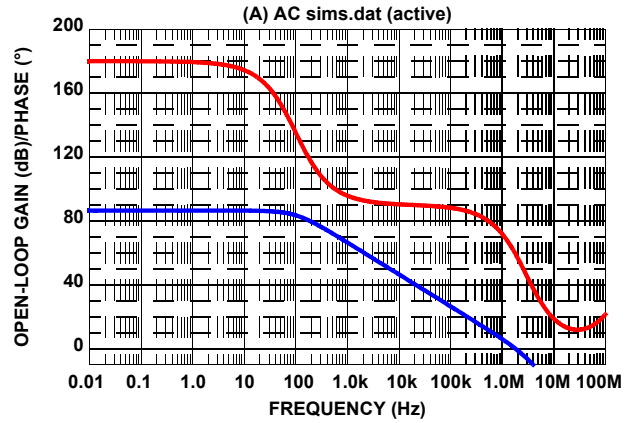

FIGURE 30. SIMULATED (SPICE) OPEN-LOOP GAIN, PHASE vs FREQUENCY

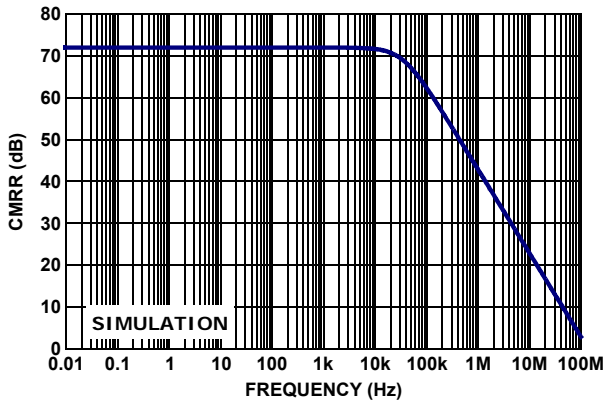

FIGURE 31. SIMULATED (DESIGN) CMRR

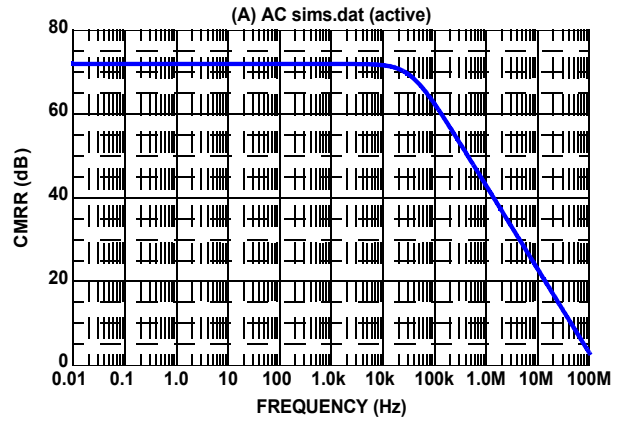

FIGURE 32. SIMULATED (SPICE) CMRR

## Revision History

The revision history provided is for informational purposes only and is believed to be accurate, but not warranted. Please go to Web to make sure you have the latest Rev.

| DATE     | REVISION | CHANGE   |
|----------|----------|--|
| 4/8/15   | FN6728.8 | Added a row to the $e_N$ parameter in the Electrical Specification table on page 5 to show low noise.<br>Corrected typo on Figures 15, 16, 17 and 27 by updating the time units from "ms" to "μs".<br>Updated the About Intersil Verbiage.   |
| 10/25/12 | FN6728.7 | Ordering Information changes on page 2:<br>Removed "italics font" on "ISL28213FHZ-T7A" entry<br>Changed on both the 28213FHZ entries, "Part Marking" from "BCP" to "BEKA"<br>Added Note 3 Lead Finish Note for 8 Ld SOT-23 package<br>Added Note 5 reference for all the SOT-23 and SC-70 entries (6 total), after the part marking, and added the note to Table.<br>Added POD P8.064 on page 23   |
| 4/16/12  | FN6728.6 | Mask changes have been made from RevA to RevB, datasheet updated to reflect new silicon.<br>Page 4: Vos limits changed from $\pm 5\text{mV}$ to $\pm 4\text{mV}$ at room temp and $\pm 6\text{mV}$ to $\pm 5\text{mV}$ at $+125^\circ\text{C}$ .<br>TcVos, Max spec removed, typical increased from 2 to 5.<br>Page 7, Replaced Figure 8 with new graph.<br>Page 7, Replaced Figure 11 with new graph.<br>Page 8, Replaced Figure 18 with new graph.   |
| 5/18/11  | FN6728.5 | - On page 2, Ordering Information table: ISL28113FHZ-T7 & -T7A PKG DWG # changed from MDP0038 (Obsoleted) to P5.064A. Removed ISL28213FHZ and added "Coming Soon" to parts ISL28213FHZ-T7A and ISL28413TSSOPEVAL1Z.<br>- On page 3, Pin Descriptions: Circuit 3 diagram, removed anti-parallel diodes from the IN+ to IN- terminals.<br>- On page 4, Absolute Maximum Ratings: changed Differential Input Voltage from "0.5V" to "V <sub>-</sub> - 0.5V to V <sub>+</sub> + 0.5V".<br>- On page 4, updated CMRR and PSRR parameters in Electrical Specifications table with test condition specifying $-40^\circ\text{C}$ to $+125^\circ\text{C}$ typical parameter.<br>- On page 5, updated Note 6 ("over-temp" note) referenced in MIN and MAX column headings of Electrical Specifications table from "Parameters with MIN and/or MAX limits are 100% tested at $+25^\circ\text{C}$ , unless otherwise specified. Temperature limits established by characterization and are not production tested." to new standard "Compliance to datasheet limits is assured by one or more methods: production test, characterization and/or design."<br>- On page 9, under "Input ESD Diode Protection," removed "They also contain back to-back diodes across the input terminals." Changed "For applications where the input differential voltage is expected to exceed 0.5V, an external series resistor..." to "For applications where the input differential voltage may exceed either power supply voltage by 0.5V or more, an external series resistor...". Removed "Although the amplifier is fully protected, high input slew rates that exceed the amplifier slew rate ( $\pm 1\text{V}/\mu\text{s}$ ) may cause output distortion."<br>- On page 9, Figure 19: updated circuit schematic by removing back-to-back input protection diodes.<br>- On page 18, replaced Package Outline Drawing MDP0038 (obsolete) with P5.064A. |

## Revision History (Continued)

The revision history provided is for informational purposes only and is believed to be accurate, but not warranted. Please go to Web to make sure you have the latest Rev. (Continued)

| DATE     | REVISION | CHANGE  |
|----------|----------|---|
| 3/23/10  | FN6728.4 | <p>Page 1, 2nd paragraph - Added "...SOT23-8 packages..." and changed "S08" to "SOIC8".<br/>Also global, changed S08 to SOIC8</p> <p>Pg 2, Ordering Information table: Part # ISL28213FEZ changed to ISL28213FHZ and Part Marking changed to "TBD"</p> <p>-Added Related Literature on page 1, updated ordering information by adding Eval boards.<br/>-Added to ordering information part number ISL28213FHZ 8 Ld SOT-23 Package as coming soon.<br/>-Replaced Figure 24 Simulated Input Noise Voltage with following changes:<br/>Y-axis from "10 to 100" to "10,000 to 10"<br/>Removed (A) AC sims.dat (active) from top of graph<br/>Curve changed to improve noise performance<br/>Made changes to Spice Net List as follows:<br/>-Changed Revision from "C" to "D" and added improved noise performance to Revision line.<br/>-Changed in Voltage Noise<br/>"V_V9 29 0 .00035" to "V_V9 29 0 0.45"<br/>"R_R21 28 0 800E3 TC=0,0" to "R_R21 28 0 30"<br/>-Removed TC=0 in Input Stage from R_R1 through C_Cin2<br/>-Removed TC=0 in 1st Gain Stage from R_R9 through R_R12<br/>-Removed TC=0 in 2nd Gain Stage from R_R13 through C_C3<br/>-Changed in Common Mode Gain Stage with Zero<br/>"G_G5 V++ VC VCM VMID 2.5118E-10" to "G_G5 V++ VC VCM VMID 0.25118"<br/>"G_G6 V- VC VCM VMID 2.5118E-10" to "G_G6 V- VC VCM VMID 0.25118"<br/>Removed TC=0 from R_R16 through R_R23<br/>-Changed in Pole Stage<br/>"G_G7 V++ 23 VG VMID 188.49e-6" to "G_G7 V++ 23 VG VMID 0.18849"<br/>"G_G8 V- 23 VG VMID 188.49e-6" to "G_G8 V- 23 VG VMID 0.18849"<br/>Removed TC=0 from R_R17 through C_C5<br/>Removed TC=0 in Output Stage with Correction Current Sources from R_R19 and R_R20<br/>Made changes to Spice Schematic Figure 21 as follows:<br/>-Input Stage - Modified connection to the EOS (voltage control voltage source)<br/>-Added to Thermal Information 8 LD SOT-23 as TBD<br/>-Added to pin configuration for the ISL28213 8 Ld SOT-23</p> |
| 12/16/09 | FN6728.3 | <p>Removed "Coming Soon" from MSOP package options in the "Ordering Information" on page 2.<br/>Updated the Theta JA for the MSOP package option from 170 °C/W to 180 °C/W on page 4.</p>   |
| 11/17/09 | FN6728.2 | <p>Removed "Coming Soon" from SC70 and SOT-23 package options in the "Ordering Information" on page 2.</p>  |
| 11/12/09 | FN6728.1 | <p>Changed theta Ja to 250 from 300. Added license statement (page 10) and reference in spice model (page 12).</p>  |
| 10/26/09 | FN6728.0 | Initial Release   |

## About Intersil

Intersil Corporation is a leading provider of innovative power management and precision analog solutions. The company's products address some of the largest markets within the industrial and infrastructure, mobile computing and high-end consumer markets.

For the most updated datasheet, application notes, related documentation and related parts, please see the respective product information page found at [www.intersil.com](http://www.intersil.com).

You may report errors or suggestions for improving this datasheet by visiting [www.intersil.com/ask](http://www.intersil.com/ask).

Reliability reports are also available from our website at [www.intersil.com/support](http://www.intersil.com/support)



**Small Outline Transistor Plastic Packages (SC70-5)**

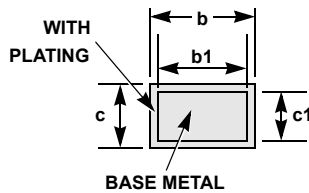
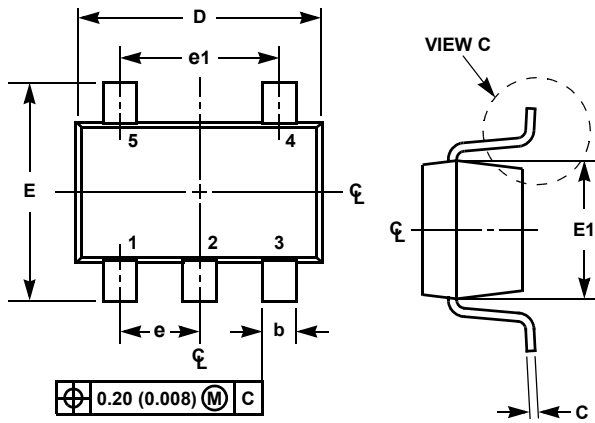

TYPICAL RECOMMENDED LAND PATTERN

**P5.049**

**5 LEAD SMALL OUTLINE TRANSISTOR PLASTIC PACKAGE**

| SYMBOL | INCHES     |       | MILLIMETERS |      | NOTES |
|--------|------------|-------|-------------|------|-------|
|        | MIN        | MAX   | MIN         | MAX  |       |
| A      | 0.031      | 0.043 | 0.80        | 1.10 | -     |
| A1     | 0.000      | 0.004 | 0.00        | 0.10 | -     |
| A2     | 0.031      | 0.039 | 0.80        | 1.00 | -     |
| b      | 0.006      | 0.012 | 0.15        | 0.30 | -     |
| b1     | 0.006      | 0.010 | 0.15        | 0.25 | -     |
| c      | 0.003      | 0.009 | 0.08        | 0.22 | 6     |
| c1     | 0.003      | 0.009 | 0.08        | 0.20 | 6     |
| D      | 0.073      | 0.085 | 1.85        | 2.15 | 3     |
| E      | 0.071      | 0.094 | 1.80        | 2.40 | -     |
| E1     | 0.045      | 0.053 | 1.15        | 1.35 | 3     |
| e      | 0.0256 Ref |       | 0.65 Ref    |      | -     |
| e1     | 0.0512 Ref |       | 1.30 Ref    |      | -     |
| L      | 0.010      | 0.018 | 0.26        | 0.46 | 4     |
| L1     | 0.017 Ref. |       | 0.420 Ref.  |      | -     |
| L2     | 0.006 BSC  |       | 0.15 BSC    |      | -     |
| α      | 0°         | 8°    | 0°          | 8°   | -     |
| N      | 5          |       | 5           |      | 5     |
| R      | 0.004      | -     | 0.10        | -    | -     |
| R1     | 0.004      | 0.010 | 0.15        | 0.25 | -     |

Rev. 3 7/07

**NOTES:**

1. Dimensioning and tolerances per ASME Y14.5M-1994.
2. Package conforms to EIAJ SC70 and JEDEC MO-203AA.
3. Dimensions D and E1 are exclusive of mold flash, protrusions, or gate burrs.
4. Footlength L measured at reference to gauge plane.
5. "N" is the number of terminal positions.
6. These Dimensions apply to the flat section of the lead between 0.08mm and 0.15mm from the lead tip.
7. Controlling dimension: MILLIMETER. Converted inch dimensions are for reference only.



# Package Outline Drawing

## M8.118A

8 LEAD MINI SMALL OUTLINE PLASTIC PACKAGE (MSOP)

Rev 0, 9/09

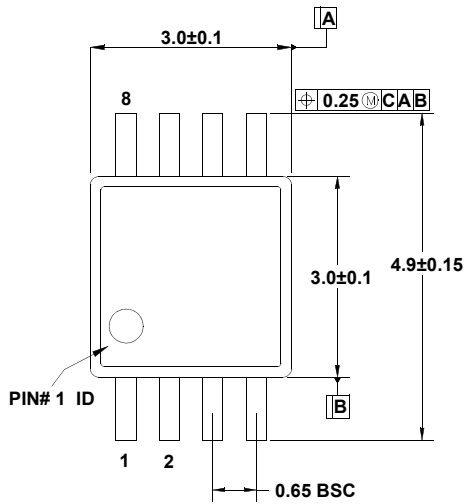

**TOP VIEW**

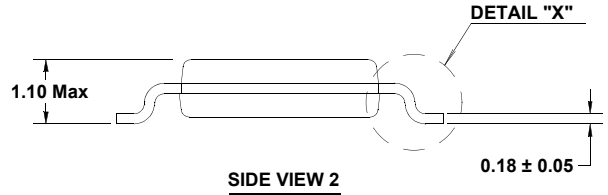

**SIDE VIEW 2**

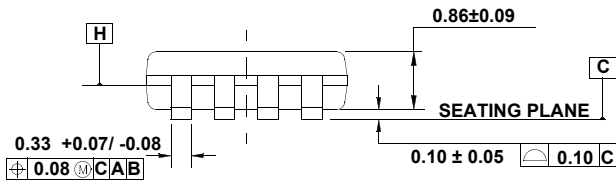

**SIDE VIEW 1**

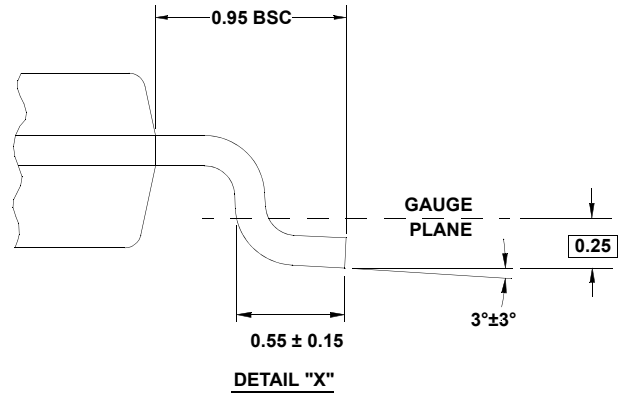

**DETAIL "X"**

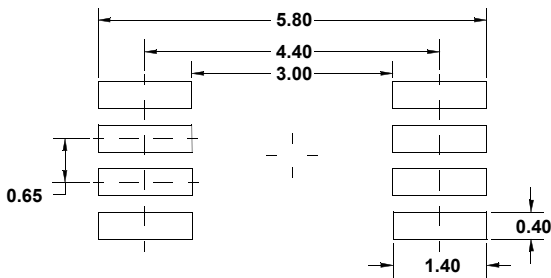

**TYPICAL RECOMMENDED LAND PATTERN**

**NOTES:**

1. Dimensions are in millimeters.
2. Dimensioning and tolerancing conform to JEDEC MO-187-AA and AMSE Y14.5m-1994.
3. Plastic or metal protrusions of 0.15mm max per side are not included.
4. Plastic interlead protrusions of 0.25mm max per side are not included.
5. Dimensions "D" and "E1" are measured at Datum Plane "H".
6. This replaces existing drawing # MDP0043 MSOP 8L.

# Package Outline Drawing

## M8.15E

8 LEAD NARROW BODY SMALL OUTLINE PLASTIC PACKAGE

Rev 0, 08/09



NOTES:

1. Dimensions are in millimeters.  
Dimensions in ( ) for Reference Only.
2. Dimensioning and tolerancing conform to AMSE Y14.5m-1994.
3. Unless otherwise specified, tolerance : Decimal ± 0.05
4. Dimension does not include interlead flash or protrusions.  
Interlead flash or protrusions shall not exceed 0.25mm per side.
5. The pin #1 identifier may be either a mold or mark feature.
6. Reference to JEDEC MS-012.

**Small Outline Package Family (SO)**

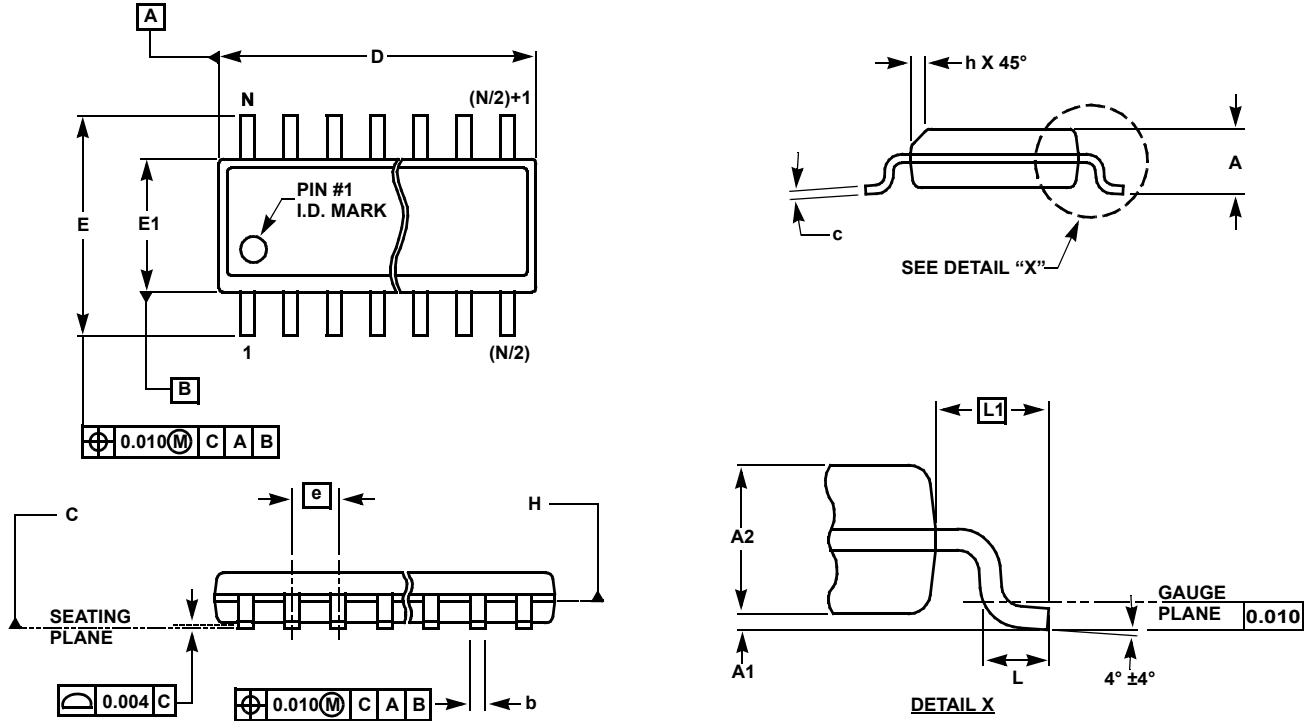

**MDP0027**

**SMALL OUTLINE PACKAGE FAMILY (SO)**

| SYMBOL | INCHES |       |               |                        |               |               |               | TOLERANCE   | NOTES |
|--------|--------|-------|---------------|------------------------|---------------|---------------|---------------|-------------|-------|
|        | SO-8   | SO-14 | SO16 (0.150") | SO16 (0.300") (SOL-16) | SO20 (SOL-20) | SO24 (SOL-24) | SO28 (SOL-28) |             |       |
| A      | 0.068  | 0.068 | 0.068         | 0.104                  | 0.104         | 0.104         | 0.104         | MAX         | -     |
| A1     | 0.006  | 0.006 | 0.006         | 0.007                  | 0.007         | 0.007         | 0.007         | $\pm 0.003$ | -     |
| A2     | 0.057  | 0.057 | 0.057         | 0.092                  | 0.092         | 0.092         | 0.092         | $\pm 0.002$ | -     |
| b      | 0.017  | 0.017 | 0.017         | 0.017                  | 0.017         | 0.017         | 0.017         | $\pm 0.003$ | -     |
| c      | 0.009  | 0.009 | 0.009         | 0.011                  | 0.011         | 0.011         | 0.011         | $\pm 0.001$ | -     |
| D      | 0.193  | 0.341 | 0.390         | 0.406                  | 0.504         | 0.606         | 0.704         | $\pm 0.004$ | 1, 3  |
| E      | 0.236  | 0.236 | 0.236         | 0.406                  | 0.406         | 0.406         | 0.406         | $\pm 0.008$ | -     |
| E1     | 0.154  | 0.154 | 0.154         | 0.295                  | 0.295         | 0.295         | 0.295         | $\pm 0.004$ | 2, 3  |
| e      | 0.050  | 0.050 | 0.050         | 0.050                  | 0.050         | 0.050         | 0.050         | Basic       | -     |
| L      | 0.025  | 0.025 | 0.025         | 0.030                  | 0.030         | 0.030         | 0.030         | $\pm 0.009$ | -     |
| L1     | 0.041  | 0.041 | 0.041         | 0.056                  | 0.056         | 0.056         | 0.056         | Basic       | -     |
| h      | 0.013  | 0.013 | 0.013         | 0.020                  | 0.020         | 0.020         | 0.020         | Reference   | -     |
| N      | 8      | 14    | 16            | 16                     | 20            | 24            | 28            | Reference   | -     |

Rev. M 2/07

NOTES:

1. Plastic or metal protrusions of 0.006" maximum per side are not included.
2. Plastic interlead protrusions of 0.010" maximum per side are not included.
3. Dimensions "D" and "E1" are measured at Datum Plane "H".
4. Dimensioning and tolerancing per ASME Y14.5M-1994

**Thin Shrink Small Outline Package Family (TSSOP)**

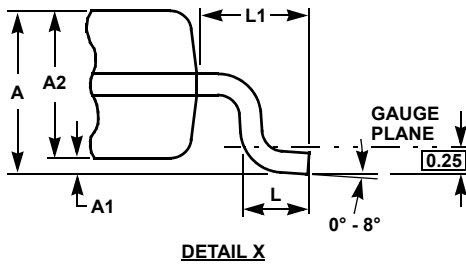
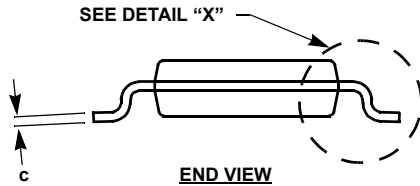
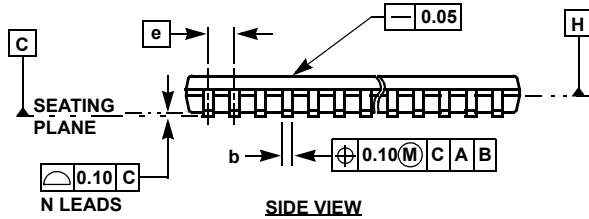
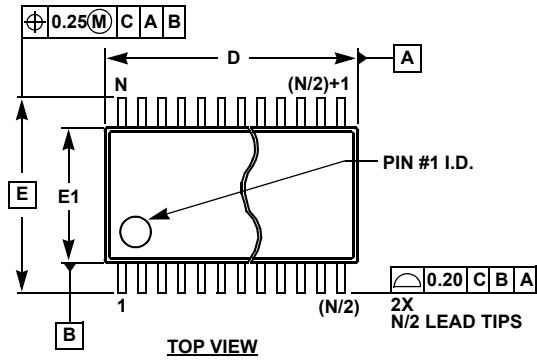

**MDP0044**

**THIN SHRINK SMALL OUTLINE PACKAGE FAMILY**

| SYMBOL | MILLIMETERS |       |       |       |       | TOLERANCE   |
|--------|-------------|-------|-------|-------|-------|-------------|
|        | 14 LD       | 16 LD | 20 LD | 24 LD | 28 LD |             |
| A      | 1.20        | 1.20  | 1.20  | 1.20  | 1.20  | Max         |
| A1     | 0.10        | 0.10  | 0.10  | 0.10  | 0.10  | ±0.05       |
| A2     | 0.90        | 0.90  | 0.90  | 0.90  | 0.90  | ±0.05       |
| b      | 0.25        | 0.25  | 0.25  | 0.25  | 0.25  | +0.05/-0.06 |
| c      | 0.15        | 0.15  | 0.15  | 0.15  | 0.15  | +0.05/-0.06 |
| D      | 5.00        | 5.00  | 6.50  | 7.80  | 9.70  | ±0.10       |
| E      | 6.40        | 6.40  | 6.40  | 6.40  | 6.40  | Basic       |
| E1     | 4.40        | 4.40  | 4.40  | 4.40  | 4.40  | ±0.10       |
| e      | 0.65        | 0.65  | 0.65  | 0.65  | 0.65  | Basic       |
| L      | 0.60        | 0.60  | 0.60  | 0.60  | 0.60  | ±0.15       |
| L1     | 1.00        | 1.00  | 1.00  | 1.00  | 1.00  | Reference   |

Rev. F 2/07

**NOTES:**

1. Dimension "D" does not include mold flash, protrusions or gate burrs. Mold flash, protrusions or gate burrs shall not exceed 0.15mm per side.
2. Dimension "E1" does not include interlead flash or protrusions. Interlead flash and protrusions shall not exceed 0.25mm per side.
3. Dimensions "D" and "E1" are measured at dAtum Plane H.
4. Dimensioning and tolerancing per ASME Y14.5M-1994.