

ISL28114, ISL28214, ISL28414

Single, Dual, Quad General Purpose Micropower, RRIO Operational Amplifiers

FN6800  
Rev 10.00  
December 8, 2016

The [ISL28114](#), [ISL28214](#), and [ISL28414](#) are single, dual, and quad channel general purpose micropower, rail-to-rail input and output operational amplifiers with supply voltage range of 1.8V to 5.5V. Key features are a low supply current of 390µA maximum per channel at room temperature, a low bias current, and a wide input voltage range, which enables the ISL28x14 devices to be excellent general purpose op amps for a wide range of applications.

The ISL28114 is available in the SC70-5 and SOT23-5 packages, the ISL28214 is in the MSOP8, S08, and SOT23-8 packages, and the ISL28414 is in the TSSOP14 and SOIC14 packages. All devices operate across the extended temperature range of -40°C to +125°C.

**Related Literature**

- For a full list of related documents, visit our website
  - [ISL28114](#), [ISL28214](#) and [ISL28414](#) product pages

**Features**

- Low current consumption ..... 390µA
- Wide supply range ..... 1.8V to 5.5V
- Gain-bandwidth product ..... 5MHz
- Input bias current. .... 20pA, Max.
- Operating temperature range. .... -40°C to +125°C
- Packages
  - ISL28114 (single)..... SC70-5, SOT23-5
  - ISL28214 (dual)..... MSOP8, S08, SOT23-8
  - ISL28414 (quad)..... SOIC14, TSSOP14

**Applications**

- Power supply control/regulation
- Process control
- Signal gain/buffers
- Active filters
- Current shunt sensing
- Transimpedance amp

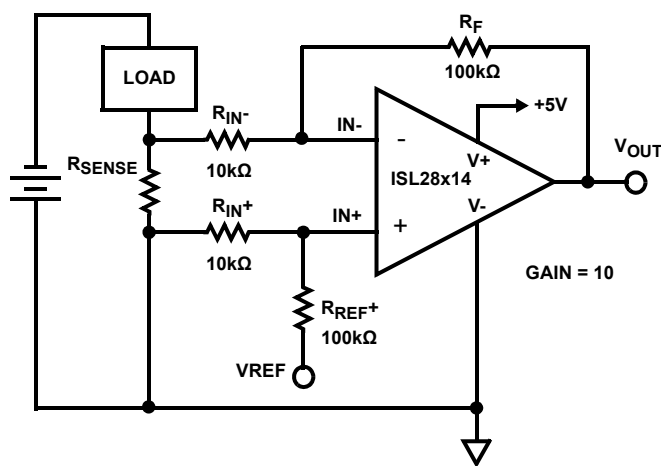

SINGLE-SUPPLY, LOW-SIDE CURRENT SENSE AMPLIFIER

FIGURE 1. TYPICAL APPLICATION

## Ordering Information

PART NUMBER (Note 4)	PART MARKING	TAPE AND REEL (UNITS)	PACKAGE (RoHS COMPLIANT)	PKG. DWG. #
ISL28114FEZ-T7 (Notes 1, 2)	BKA (Note 5)	3k	5 Ld SC-70	P5.049
ISL28114FEZ-T7A (Notes 1, 2)	BKA (Note 5)	250	5 Ld SC-70	P5.049
ISL28114FHZ-T7 (Notes 1, 2)	BDBA (Note 5)	3k	5 Ld SOT-23	P5.064A
ISL28114FHZ-T7A (Notes 1, 2)	BDBA (Note 5)	250	5 Ld SOT-23	P5.064A
ISL28214FUZ (Note 2)	8214Z	-	8 Ld MSOP	M8.118A
ISL28214FUZ-T7 (Notes 1, 2)	8214Z	1.5k	8 Ld MSOP	M8.118A
ISL28214FBZ (Note 2)	28214 FBZ	-	8 Ld SOIC	M8.15E
ISL28214FBZ-T7 (Notes 1, 2)	28214 FBZ	1k	8 Ld SOIC	M8.15E
ISL28214FBZ-T13 (Notes 1, 2)	28214 FBZ	2.5k	8 Ld SOIC	M8.15E
ISL28214FHZ-T7 (Notes 1, 3)	BELA (Note 5)	3k	8 Ld SOT-23	P8.064
ISL28214FHZ-T7A (Notes 1, 3)	BELA (Note 5)	250	8 Ld SOT-23	P8.064
ISL28414FVZ (Note 2)	28414 FVZ	-	14 Ld TSSOP	MDP0044
ISL28414FVZ-T7 (Notes 1, 2)	28414 FVZ	1k	14 Ld TSSOP	MDP0044
ISL28414FVZ-T13 (Notes 1, 2)	28414 FVZ	2.5k	14 Ld TSSOP	MDP0044
ISL28414FBZ (Note 2)	28414 FBZ	-	14 Ld SOIC	MDP0027
ISL28414FBZ-T7 (Notes 1, 2)	28414 FBZ	1k	14 Ld SOIC	MDP0027
ISL28414FBZ-T13 (Notes 1, 2)	28414 FBZ	2.5k	14 Ld SOIC	MDP0027
ISL28114SOT23EVAL1Z	Evaluation Board			
ISL28214MSOPEVAL2Z	Evaluation Board			
ISL28214SOICEVAL2Z	Evaluation Board			
ISL28414TSSOPEVAL1Z	Evaluation Board			

### NOTES:

1. Refer to [TB347](#) for details on reel specifications.
2. These Intersil Pb-free plastic packaged products employ special Pb-free material sets, molding compounds/die attach materials, and 100% matte tin plate plus anneal (e3 termination finish, which is RoHS compliant and compatible with both SnPb and Pb-free soldering operations). Intersil Pb-free products are MSL classified at Pb-free peak reflow temperatures that meet or exceed the Pb-free requirements of IPC/JEDEC J STD-020.
3. These Intersil Pb-free plastic packaged products employ special Pb-free material sets, molding compounds/die attach materials, and NiPdAu plate-e4 termination finish, which is RoHS compliant and compatible with both SnPb and Pb-free soldering operations. Intersil Pb-free products are MSL classified at Pb-free peak reflow temperatures that meet or exceed the Pb-free requirements of IPC/JEDEC J STD-020.
4. For Moisture Sensitivity Level (MSL), see device information page for [ISL28114](#), [ISL28214](#), [ISL28414](#). For more information on MSL, see Tech Brief [TB363](#).
5. The part marking is located on the bottom of the part.

## Pin Configurations

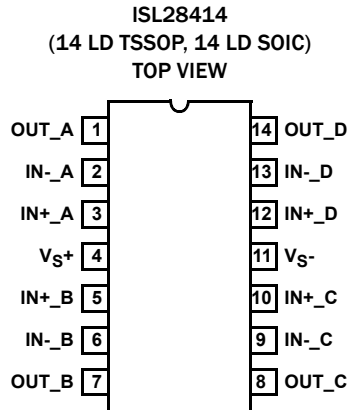
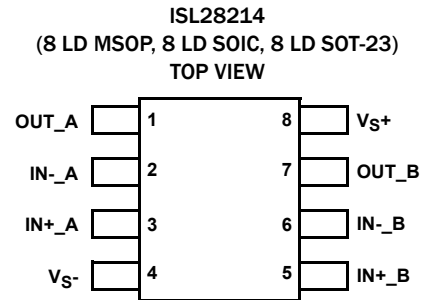
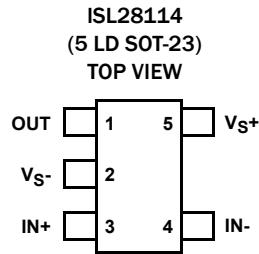
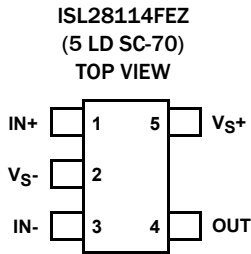

## Pin Descriptions

PIN NAME	PIN NUMBER				DESCRIPTION	CIRCUITS
	5 Ld SC-70	5 Ld SOT-23	8 Ld MSOP, 8 Ld SOIC, 8 Ld SOT-23	14 Ld TSSOP, 14 LD SOIC		
OUT OUT_A OUT_B OUT_C OUT_D	4	1	1 7	1 7 8 14	Output	 CIRCUIT 1
VS-	2	2	4	11	Negative supply voltage	 CIRCUIT 2
IN+ IN+_A IN+_B IN+_C IN+_D	1	3	3 5	3 5 10 12	Positive Input	 CIRCUIT 3
IN- IN-_A IN-_B IN-_C IN-_D	3	4	2 6	2 6 9 13	Negative Input	
VS+	5	5	8	4	Positive supply voltage	See <a href="#">"CIRCUIT 2"</a>

**Absolute Maximum Ratings** ( $T_A = +25^\circ\text{C}$ )

Supply Voltage	6.5V
Supply Turn-on Voltage Slew Rate	1V/ $\mu\text{s}$
Differential Input Current	20mA
Differential Input Voltage	$V_- - 0.5\text{V}$ to $V_+ + 0.5\text{V}$
Input Voltage	$V_- - 0.5\text{V}$ to $V_+ + 0.5\text{V}$
ESD Rating	
Human Body Model	4kV
Machine Model (ISL28114, ISL28214)	350V
Machine Model (ISL28414)	400V
Charged Device Model	2kV

**Thermal Information**

Thermal Resistance (Typical)	$\theta_{JA}$ ( $^\circ\text{C}/\text{W}$ )	$\theta_{JC}$ ( $^\circ\text{C}/\text{W}$ )
5 Ld SC-70 (Notes 6)	250	N/A
5 Ld SOT-23 (Notes 6)	225	N/A
8 Ld MSOP (Notes 6, 7)	180	100
8 Ld SOIC Package (Notes 6, 7)	126	90
8 Ld SOT-23 Package (Notes 6, 7)	240	168
14 Ld TSSOP Package (Notes 6, 7)	120	40
14 Ld SOIC Package (Notes 6, 7)	90	50
Ambient Operating Temperature Range	-40 $^\circ\text{C}$ to +125 $^\circ\text{C}$	
Storage Temperature Range	-65 $^\circ\text{C}$ to +150 $^\circ\text{C}$	
Operating Junction Temperature	+125 $^\circ\text{C}$	
Pb-Free Reflow Profile	see <a href="#">TB493</a>	

**CAUTION:** Do not operate at or near the maximum ratings listed for extended periods of time. Exposure to such conditions may adversely impact product reliability and result in failures not covered by warranty.

## NOTES:

- $\theta_{JA}$  is measured with the component mounted on a high-effective thermal conductivity test board in free air. See Tech Brief [TB379](#) for details.
- For  $\theta_{JC}$ , the "case temp" location is taken at the package top center.

**Electrical Specifications**  $V_{S+} = 5\text{V}$ ,  $V_{S-} = 0\text{V}$ ,  $R_L = \text{Open}$ ,  $V_{CM} = V_S/2$ ,  $T_A = +25^\circ\text{C}$ , unless otherwise specified. **Boldface limits apply across the operating temperature range, -40 $^\circ\text{C}$  to +125 $^\circ\text{C}$ , unless otherwise specified.**

PARAMETER	DESCRIPTION	TEST CONDITIONS	MIN (Note 8)	TYP	MAX (Note 8)	UNIT
<b>DC SPECIFICATIONS</b>						
$V_{OS}$	Input Offset Voltage		-4	0.5	4	mV
		-40 $^\circ\text{C}$ to +125 $^\circ\text{C}$	<b>-5</b>		<b>5</b>	mV
$TCV_{OS}$	Input Offset Voltage Temperature Coefficient	-40 $^\circ\text{C}$ to +125 $^\circ\text{C}$		<b>5</b>		$\mu\text{V}/^\circ\text{C}$
$I_{OS}$	Input Offset Current			1	30	$\mu\text{A}$
$I_B$	Input Bias Current	ISL28114	-20	3	20	$\mu\text{A}$
			<b>-100</b>		<b>100</b>	$\mu\text{A}$
		ISL28214, ISL28414	-20	3	20	$\mu\text{A}$
			<b>-50</b>		<b>50</b>	$\mu\text{A}$
	Common-Mode Input Voltage Range		<b>-0.1</b>		<b>5.1</b>	V
CMRR	Common-Mode Rejection Ratio	$V_{CM} = -0.1\text{V}$ to $5.1\text{V}$		72		dB
		-40 $^\circ\text{C}$ to +125 $^\circ\text{C}$		70		dB
PSRR	Power Supply Rejection Ratio	$V_S = 1.8\text{V}$ to $5.5\text{V}$		71		dB
		-40 $^\circ\text{C}$ to +125 $^\circ\text{C}$		70		dB
$V_{OH}$	Output Voltage Swing, High	$R_L = 10\text{k}\Omega$	4.985	4.993		V
			<b>4.98</b>			V
$V_{OL}$	Output Voltage Swing, Low	$R_L = 10\text{k}\Omega$		13	15	mV
					<b>20</b>	mV
$V_+$	Supply Voltage		1.8		5.5	V
$I_S$	Supply Current per Amplifier	$R_L = \text{OPEN}$		300	390	$\mu\text{A}$
					<b>475</b>	$\mu\text{A}$
$I_{SC+}$	Output Source Short-Circuit Current	$R_L = 10\Omega$ to $V_-$		-31		mA
$I_{SC-}$	Output Sink Short-Circuit Current	$R_L = 10\Omega$ to $V_+$		26		mA

**Electrical Specifications**  $V_{S+} = 5V$ ,  $V_{S-} = 0V$ ,  $R_L = \text{Open}$ ,  $V_{CM} = V_S/2$ ,  $T_A = +25^\circ\text{C}$ , unless otherwise specified. **Boldface limits apply across the operating temperature range,  $-40^\circ\text{C}$  to  $+125^\circ\text{C}$ , unless otherwise specified. (Continued)**

PARAMETER	DESCRIPTION	TEST CONDITIONS	MIN (Note 8)	TYP	MAX (Note 8)	UNIT
<b>AC SPECIFICATIONS</b>						
GBWP	Gain-Bandwidth Product	$V_S = \pm 2.5V$ $A_V = 100$ , $R_F = 100k\Omega$ , $R_G = 1k\Omega$ , $R_L = 10k\Omega$ to $V_{CM}$		5		MHz
$e_N V_{P-P}$	Peak-to-Peak Input Noise Voltage	$V_S = \pm 2.5V$ $f = 0.1\text{Hz}$ to $10\text{Hz}$		12		$\mu V_{P-P}$
$e_N$	Input Noise Voltage Density	$V_S = \pm 2.5V$ $f = 1\text{kHz}$		40		$nV/\sqrt{\text{Hz}}$
		$V_S = \pm 2.5V$ $f = 10\text{kHz}$		16		$nV/\sqrt{\text{Hz}}$
$i_N$	Input Noise Current Density	$V_S = \pm 2.5V$ $f = 1\text{kHz}$		8		$fA/\sqrt{\text{Hz}}$
$Z_{IN}$	Input Impedance			$10^{12}$		$\Omega$
$C_{in}$	Differential Input Capacitance	$V_S = \pm 2.5V$ $f = 1\text{MHz}$		1.0		pF
	Common-Mode Input Capacitance			1.3		pF
<b>TRANSIENT RESPONSE</b>						
SR	Slew Rate	$V_{OUT} = 0.5V$ to $4.5V$		2.5		$V/\mu s$
$t_r$ , $t_f$ , Small Signal	Rise Time, $t_r$ 10% to 90%	$V_S = \pm 2.5V$		37		ns
	Fall Time, $t_f$ 10% to 90%	$A_V = +1$ , $V_{OUT} = 0.05V_{P-P}$ , $R_F = 0\Omega$ , $R_L = 10k\Omega$ , $C_L = 15pF$		42		ns
$t_s$	Settling Time to 0.1%, $4V_{P-P}$ Step	$V_S = \pm 2.5V$ $A_V = +1$ , $R_F = 0\Omega$ , $R_L = 10k\Omega$ , $C_L = 1.2pF$		5.6		$\mu s$

## NOTE:

8. Compliance to datasheet limits is assured by one or more methods: production test, characterization, and/or design.

# Typical Performance Curves $V_S = \pm 2.5V, V_{CM} = 0V, R_L = \text{Open}$ , unless otherwise specified.

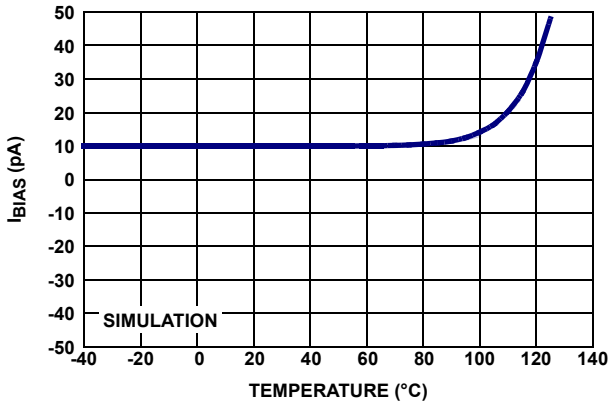

FIGURE 2. INPUT BIAS CURRENT vs TEMPERATURE

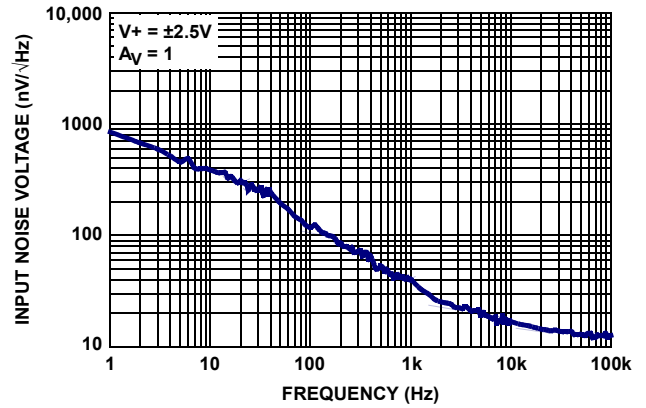

FIGURE 3. INPUT NOISE VOLTAGE SPECTRAL DENSITY

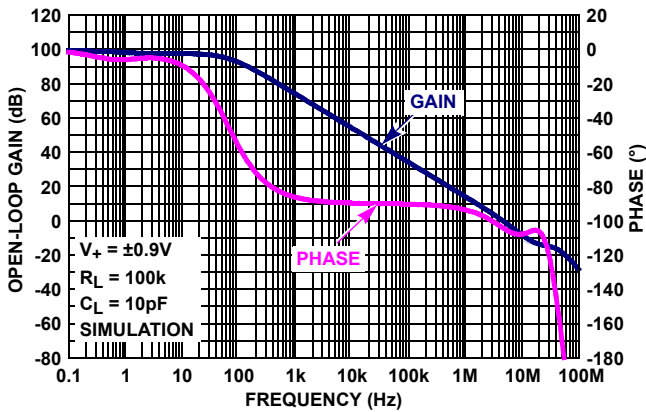

FIGURE 4. OPEN-LOOP GAIN, PHASE vs FREQUENCY,  $R_L = 100k\Omega$ ,  $C_L = 10pF$ ,  $V_S = \pm 0.9V$

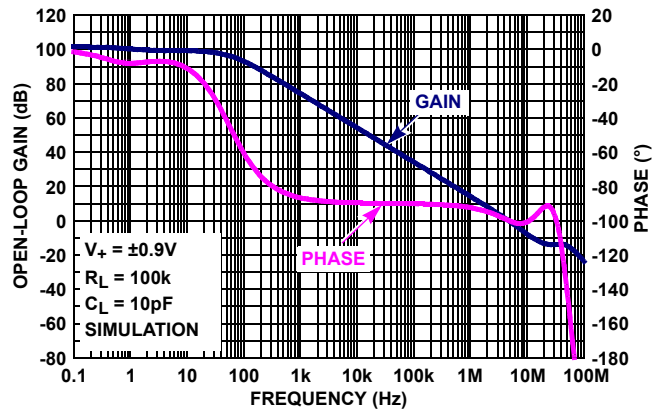

FIGURE 5. OPEN-LOOP GAIN, PHASE vs FREQUENCY,  $R_L = 100k\Omega$ ,  $C_L = 10pF$ ,  $V_S = \pm 2.5V$

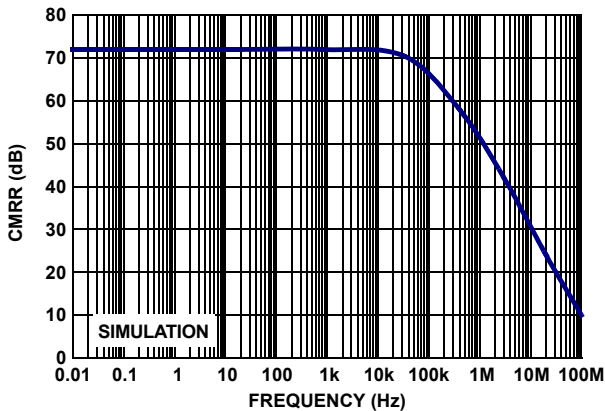

FIGURE 6. CMRR vs FREQUENCY (SIMULATED DATA)

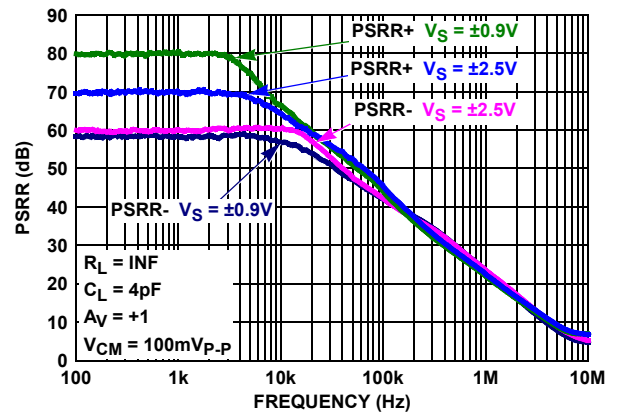

FIGURE 7. PSRR vs FREQUENCY,  $V_S = \pm 0.9V, \pm 2.5V$

# Typical Performance Curves $V_S = \pm 2.5V, V_{CM} = 0V, R_L = \text{Open}$ , unless otherwise specified. (Continued)

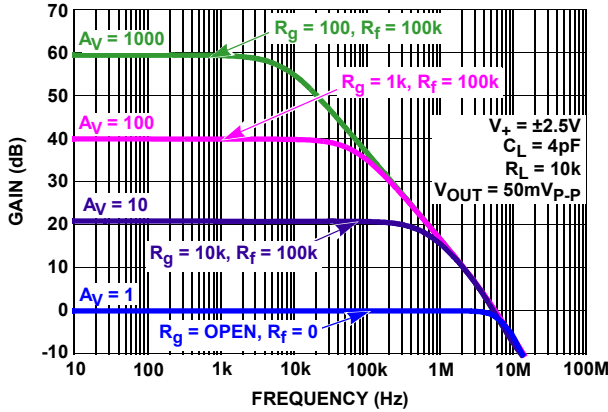

FIGURE 8. FREQUENCY RESPONSE vs CLOSED-LOOP GAIN

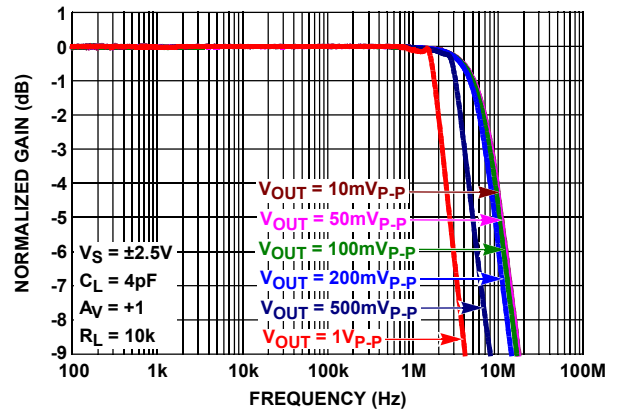

FIGURE 9. FREQUENCY RESPONSE vs  $V_{OUT}$

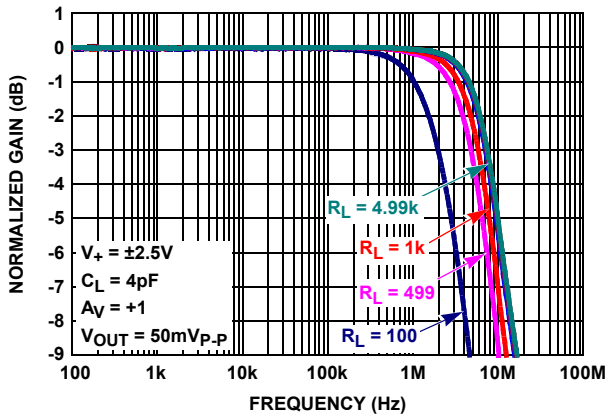

FIGURE 10. GAIN vs FREQUENCY vs  $R_L$

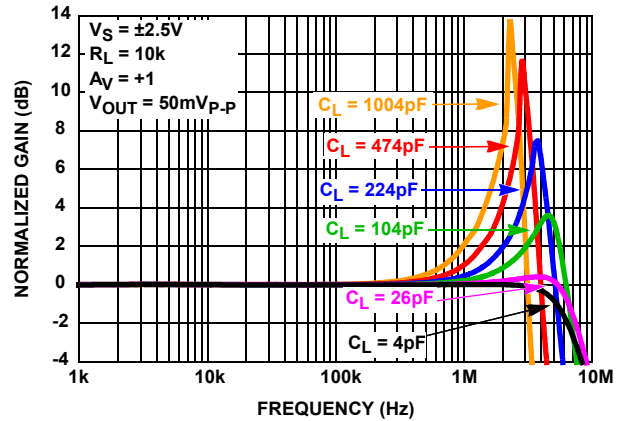

FIGURE 11. GAIN vs FREQUENCY vs  $C_L$

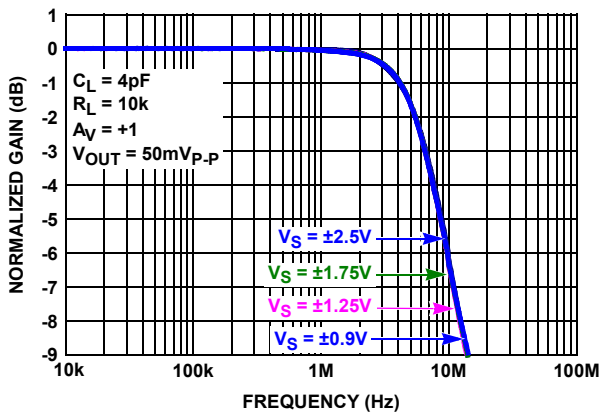

FIGURE 12. GAIN vs FREQUENCY vs SUPPLY VOLTAGE

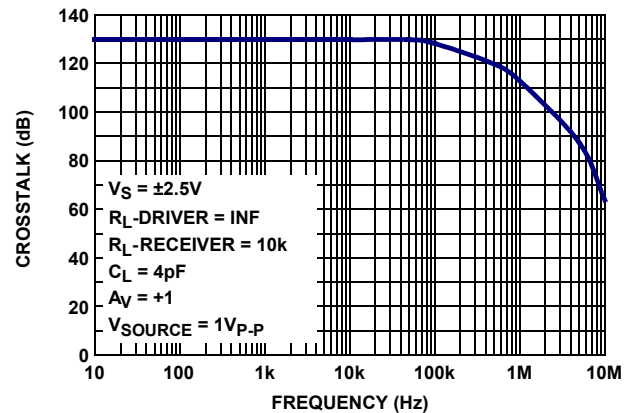

FIGURE 13. CROSSTALK,  $V_S = \pm 2.5V$

**Typical Performance Curves**  $V_S = \pm 2.5V, V_{CM} = 0V, R_L = \text{Open}$ , unless otherwise specified. (Continued)

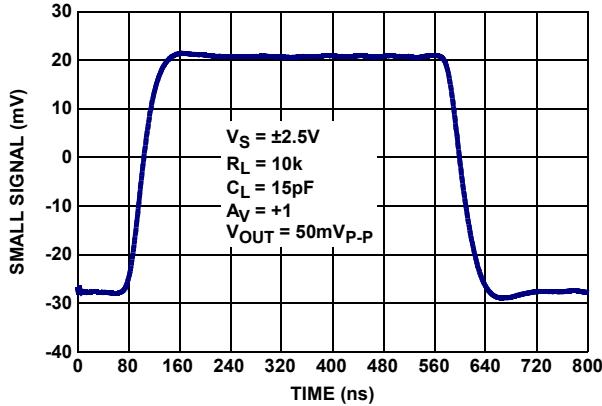

FIGURE 14. SMALL SIGNAL TRANSIENT RESPONSE,  $V_S = \pm 2.5V$

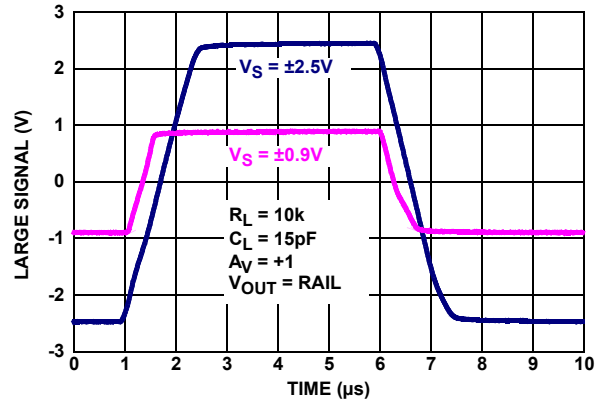

FIGURE 15. LARGE SIGNAL TRANSIENT RESPONSE vs  $R_L, V_S = \pm 0.9V, \pm 2.5V$

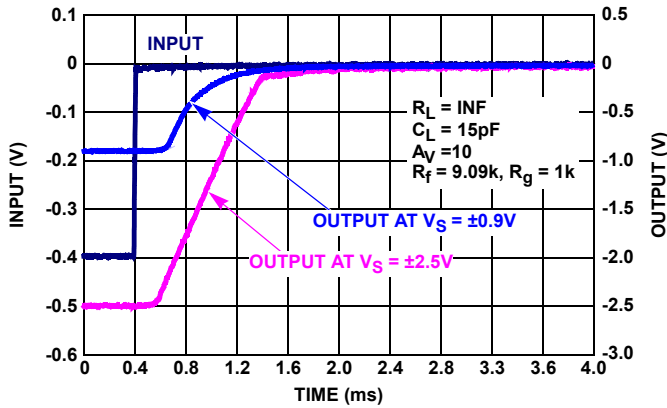

FIGURE 16. NEGATIVE OUTPUT OVERLOAD RESPONSE TIME,  $V_S = \pm 0.9V, \pm 2.5V$

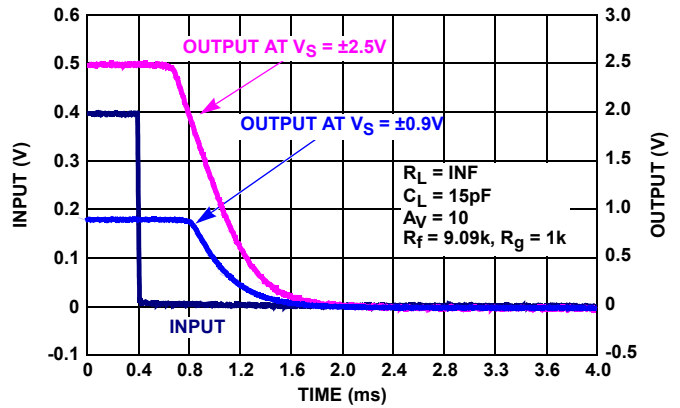

FIGURE 17. POSITIVE OUTPUT OVERLOAD RESPONSE TIME,  $V_S = \pm 0.9V, \pm 2.5V$

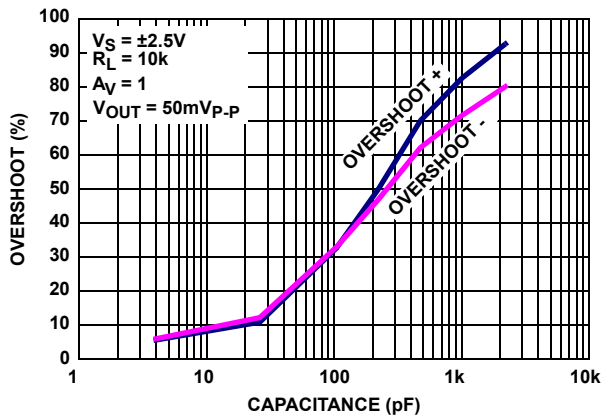

FIGURE 18. % OVERSHOOT vs LOAD CAPACITANCE,  $V_S = \pm 2.5V$



## Applications Information

### Functional Description

The ISL28114, ISL28214 and ISL28414 are single, dual, and quad, CMOS rail-to-rail input, output (RRIO) micropower operational amplifiers. They are designed to operate from single supply (1.8V to 5.5V) or dual supply ( $\pm 0.9V$  to  $\pm 2.75V$ ). The parts have an input common-mode range that extends 100mV above and below the power supply voltage rails. The output stage can swing to within 15mV of the supply rails with a 10k $\Omega$  load.

### Input ESD Diode Protection

All input terminals have internal ESD protection diodes to both positive and negative supply rails, limiting the input voltage to within one diode beyond the supply rails. For applications where the input differential voltage is expected to exceed 0.5V, an external series resistor must be used to ensure the input currents never exceed 20mA (see [Figure 19](#)).

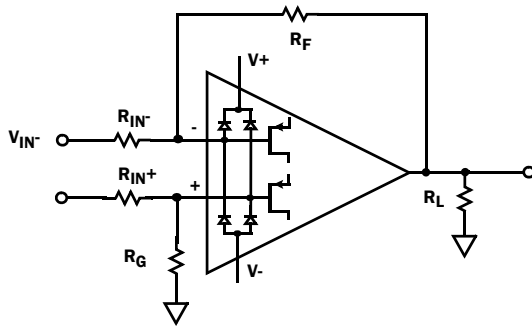

FIGURE 19. INPUT ESD DIODE CURRENT LIMITING

### Output Phase Reversal

Output phase reversal is a change of polarity in the amplifier transfer function when the input voltage exceeds the supply voltage. The ISL28114, ISL28214, and ISL28414 are immune to output phase reversal, even when the input voltage is 1V beyond the supplies.

### Unused Channels

If the application requires less than all amplifiers on one channel, the user must configure the unused channel(s) to prevent oscillation. The unused channel(s) will oscillate if the input and output pins are floating. This will result in higher than expected supply currents and possible noise injection into the channel being used. The proper way to prevent this oscillation is to short the output to the inverting input and ground the positive input (as shown in [Figure 20](#)).

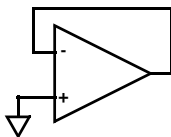

FIGURE 20. PREVENTING OSCILLATIONS IN UNUSED CHANNELS

### Power Dissipation

It is possible to exceed the +125°C maximum junction temperatures under certain load, power supply conditions, and ambient temperature conditions. It is therefore important to calculate the maximum junction temperature ( $T_{JMAX}$ ) for all applications to determine if power supply voltages, load conditions, or package types need to be modified to remain in the safe operating area. These parameters are related using [Equation 1](#):

$$T_{JMAX} = T_{MAX} + \theta_{JA} \times PD_{MAXTOTAL} \quad (EQ. 1)$$

where:

- $PD_{MAXTOTAL}$  is the sum of the maximum power dissipation of each amplifier in the package ( $PD_{MAX}$ )
- $PD_{MAX}$  for each amplifier can be calculated using [Equation 2](#):

$$PD_{MAX} = V_S \times I_{qMAX} + (V_S - V_{OUTMAX}) \times \frac{V_{OUTMAX}}{R_L} \quad (EQ. 2)$$

where:

- $T_{MAX}$  = Maximum ambient temperature
- $\theta_{JA}$  = Thermal resistance of the package
- $PD_{MAX}$  = Maximum power dissipation of 1 amplifier
- $V_S$  = Total supply voltage
- $I_{qMAX}$  = Maximum quiescent supply current of 1 amplifier
- $V_{OUTMAX}$  = Maximum output voltage swing of the application
- $R_L$  = Load resistance

### ISL28114, ISL28214, and ISL28414 SPICE Model

[Figure 21 on page 11](#) shows the SPICE model schematic and [Figure 22 on page 12](#) shows the net list for the SPICE model. The model is a simplified version of the actual device and simulates important AC and DC parameters. AC parameters incorporated into the model are: 1/f and flatband noise, Slew Rate, CMRR, Gain, and Phase. The DC parameters are IOS, total supply current, and output voltage swing. The model uses typical parameters given in the "Electrical Specifications" Table beginning on [page 4](#). The AVOL is adjusted for 90dB with the dominate pole at 125Hz. The CMRR is set 72dB,  $f = 80kHz$ . The input stage models the actual device to present an accurate AC representation. The model is configured for ambient temperature of +25°C.

[Figures 23 through 30](#) show the characterization vs simulation results for the Noise Voltage, Closed Loop Gain vs Frequency, Large Signal 5V Step Response, and CMRR and Open-Loop Gain Phase.

## **LICENSE STATEMENT**

The information in this SPICE model is protected under the United States copyright laws. Intersil Corporation hereby grants users of this macro-model hereto referred to as "Licensee", a nonexclusive, nontransferable license to use this model as long as the Licensee abides by the terms of this agreement. Before using this macro-model, the Licensee should read this license. If the Licensee does not accept these terms, permission to use the model is not granted.

The Licensee may not sell, loan, rent, or license the macro-model, in whole, in part, or in modified form, to anyone outside the Licensee's company. The Licensee may modify the macro-model to suit his/her specific applications, and the Licensee may make copies of this macro-model for use within their company only.

This macro-model is provided "AS IS, WHERE IS, AND WITH NO WARRANTY OF ANY KIND EITHER EXPRESSED OR IMPLIED, INCLUDING, BUT NOT LIMITED TO, ANY IMPLIED WARRANTIES OF MERCHANTABILITY AND FITNESS FOR A PARTICULAR PURPOSE."

In no event will Intersil be liable for special, collateral, incidental, or consequential damages in connection with or arising out of the use of this macro-model. Intersil reserves the right to make changes to the product and the macro-model without prior notice.

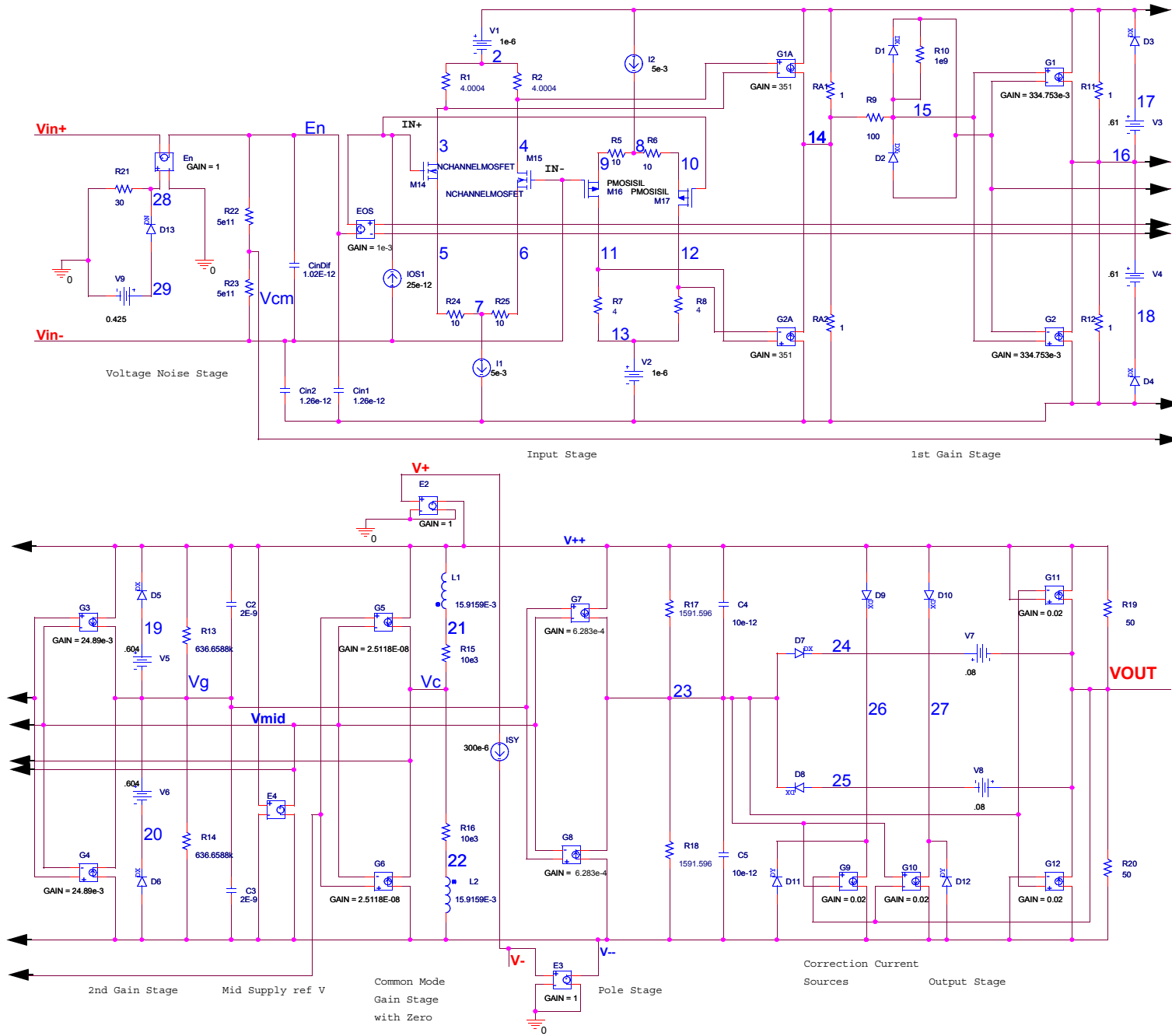

FIGURE 21. SPICE SCHEMATIC

```

*ISL28114 Macromodel - covers following
*products
*ISL28114
*ISL28214
*ISL28414
**
*Revision History:
*Revision C, LaFontaine October 20th 2011
*Model for Noise to match measured part,
* quiescent supply currents,
*CMRR 72dB
*fcm=100kHz, AVOL 90dB f=125Hz, SR =
*2.5V/us, GBWP 5MHz, 2nd pole 10Mhz
output voltage clamp and short ckt current
*limit.
**
*Copyright 2011 by Intersil Corporation
*Refer to data sheet "LICENSE
*STATEMENT" Use of this model indicates
*your acceptance with the terms and
*provisions in the License Statement.
*
*Intended use:
*This Pspice Macromodel is intended to give
*typical DC and AC performance
*characteristics under a wide range of
*external circuit configurations using
*compatible simulation platforms - such as
*iSim PE.
*
*Device performance features supported by
*this model:
*Typical, room temp., nominal power supply
*voltages used to produce the following
*characteristics:
*Open and closed loop I/O impedances
*Open loop gain and phase
*Closed loop bandwidth and frequency
*response
*Loading effects on closed loop frequency
*response
*Input noise terms including 1/f effects
*Slew rate
*Input and Output Headroom limits to I/O
*voltage swing
*Supply current at nominal specified supply
*voltages
**
*Device performance features NOT
*supported by this model
*Harmonic distortion effects
*Disable operation (if any)
*Thermal effects and/or over temperature
*parameter variation
*Limited performance variation vs. supply
*voltage is modeled
*Part to part performance variation due to
*normal process parameter spread
*Any performance difference arising from
*different packaging
* source
* Connections:  +input
*               |   -input
*               |   |   +Vsupply
*               |   |   -Vsupply
*               |   |   |   output
*               |   |   |   |
*               |   |   |   |
*               |   |   |   |
*               |   |   |   |
.subckt ISL28114 Vin+ Vin- V+ V- VOUT
* source ISL28114_DS rev2
*
*Voltage Noise
E_En VIN+ EN 28 0 1
D_D13 29 28 DN
V_V9 29 0 0.425
R_R21 28 0 30
*
*Input Stage
M_M14 3 1 5 5 NCHANNELMOSFET
M_M15 4 VIN- 6 6 NCHANNELMOSFET
M_M16 11 VIN- 9 9 PMOSISIL
M_M17 12 1 10 10 PMOSISIL
I_I1 7 V-- DC 5e-3
I_I2 V++ 8 DC 5e-3
I_IOS VIN- 1 DC 25e-12
G_G1A V++ 14 4 3 351
G_G2A V-- 14 11 12 351
V_V1 V++ 2 1e-6
V_V2 13 V-- 1e-6
R_R1 3 2 4.0004
R_R2 4 2 4.0004
R_R3 5 7 10
R_R4 7 6 10
R_R5 9 8 10
R_R6 8 10 10
R_R7 13 11 4
R_R8 13 12 4
R_RA1 14 V++ 1
R_RA2 V-- 14 1
C_CinDif VIN- EN 1.02E-12
C_Cin1 V-- EN 1.26e-12
C_Cin2 V-- VIN- 1.26e-12
*
*1st Gain Stage
G_G1 V++ 16 15 VMID 334.753e-3
G_G2 V-- 16 15 VMID 334.753e-3
V_V3 17 16 .61
V_V4 16 18 .61
D_D1 15 VMID DX
D_D2 VMID 15 DX
D_D3 17 V++ DX
D_D4 V-- 18 DX
R_R9 15 14 100
R_R10 15 VMID 1e9
R_R11 16 V++ 1
R_R12 V-- 16 1
*
*2nd Gain Stage
G_G3 V++ VG 16 VMID 24.893e-3
G_G4 V-- VG 16 VMID 24.893e-3
V_V5 19 VG .604
V_V6 VG 20 .604
D_D5 19 V++ DX
D_D6 V-- 20 DX
R_R13 VG V++ 636.658e3
R_R14 V-- VG 636.658e3
C_C2 VG V++ 2E-09
C_C3 V-- VG 2E-09
*
*Mid supply Ref
E_E4 VMID V-- V++ V-- 0.5
E_E2 V++ 0 V+ 0 1
E_E3 V-- 0 V- 0 1
I_ISY V+ V- DC 300e-6
*
*Common Mode Gain Stage with Zero
G_G5 V++ VC VCM VMID 2.5118E-8
G_G6 V-- VC VCM VMID 2.5118E-8
E_EOS 1 EN VC VMID 1e-3
*
R_R15 VC 21 10e3
R_R16 22 VC 10e3
R_R22 EN VCM 5e11
R_R23 VCM VIN- 5e11
L_L1 21 V++ 15.9159e-3
L_L2 22 V-- 15.9159e-3
*
*Pole Stage
G_G7 V++ 23 VG VMID 6.283e-4
G_G8 V-- 23 VG VMID 6.283e-4
R_R17 23 V++ 1591.596
R_R18 V-- 23 1591.596
C_C4 23 V++ 10e-12
C_C5 V-- 23 10e-12
*
*Output Stage with Correction Current
Sources
G_G9 26 V-- VOUT 23 0.02
G_G10 27 V-- 23 VOUT 0.02
G_G11 VOUT V++ V++ 23 0.02
G_G12 V-- VOUT 23 V-- 0.02
V_V7 24 VOUT .08
V_V8 VOUT 25 .08
D_D7 23 24 DX
D_D8 25 23 DX
D_D9 V++ 26 DX
D_D10 V++ 27 DX
D_D11 V-- 26 DY
D_D12 V-- 27 DY
R_R19 VOUT V++ 50
R_R20 V-- VOUT 50
.model pmosil pmos (kp=16e-3 vto=-0.6)
.model NCHANNELMOSFET nmos (kp=3e-3
vto=0.6)
.model DN D(KF=6.69e-9 AF=1)
.MODEL DX D(IS=1E-12 Rs=0.1)
.MODEL DY D(IS=1E-15 BV=50 Rs=1)
.ends ISL28114

```

FIGURE 22. SPICE NET LIST

# Characterization vs Simulation Results

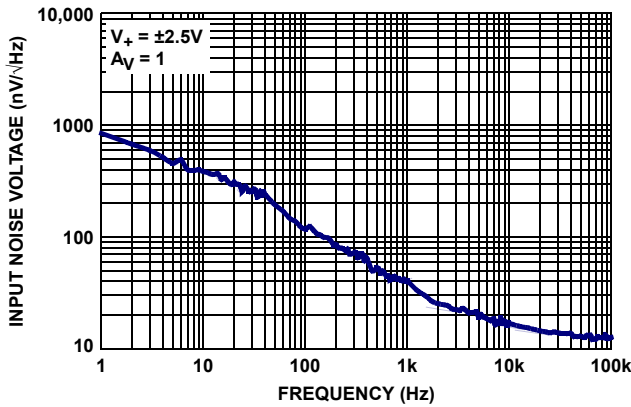

FIGURE 23. CHARACTERIZED INPUT NOISE VOLTAGE

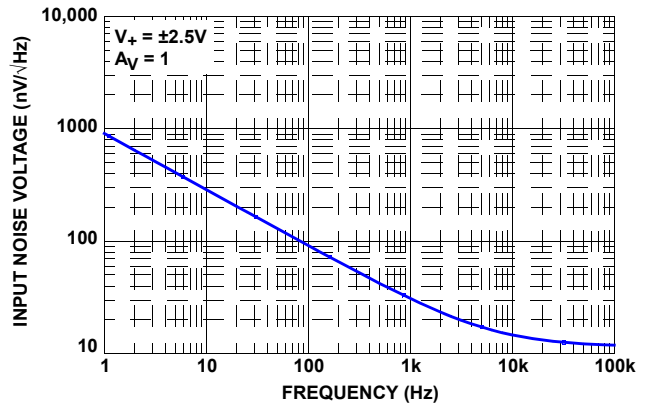

FIGURE 24. SIMULATED INPUT NOISE VOLTAGE

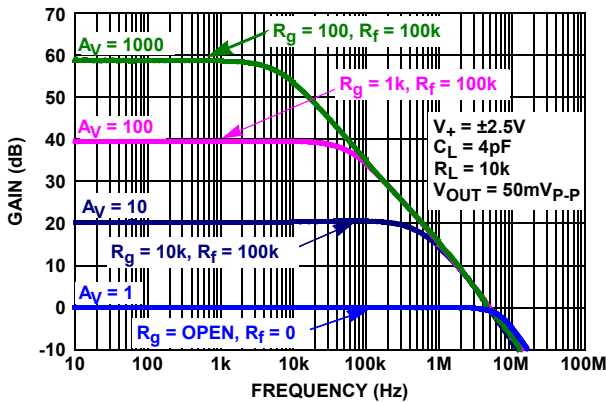

FIGURE 25. CHARACTERIZED CLOSED-LOOP GAIN vs FREQUENCY

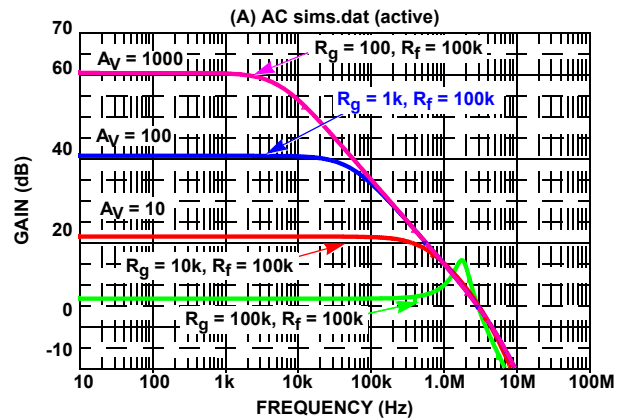

FIGURE 26. SIMULATED CLOSED-LOOP GAIN vs FREQUENCY

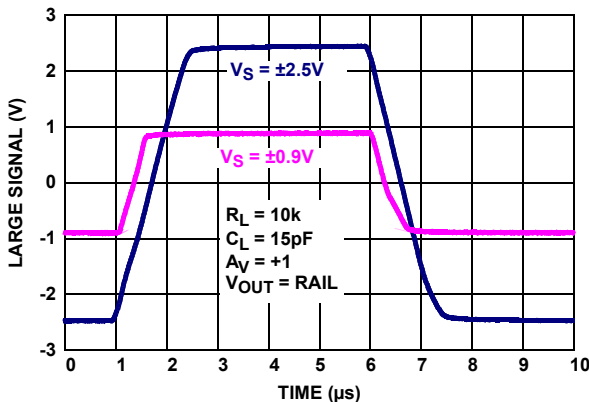

FIGURE 27. CHARACTERIZED LARGE SIGNAL TRANSIENT RESPONSE vs  $R_L$ ,  $V_S = \pm 0.9V, \pm 2.5V$

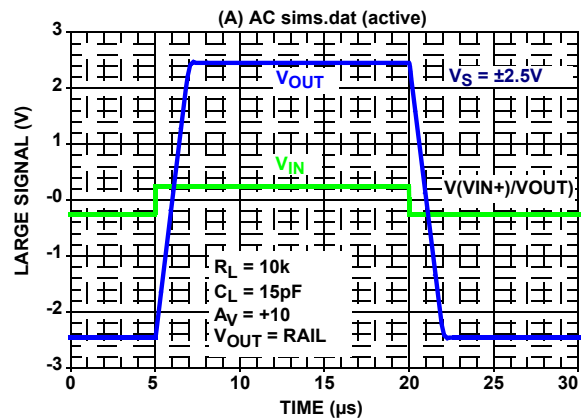

FIGURE 28. SIMULATED LARGE SIGNAL TRANSIENT RESPONSE vs  $R_L$ ,  $V_S = \pm 0.9V, \pm 2.5V$

## Characterization vs Simulation Results (Continued)

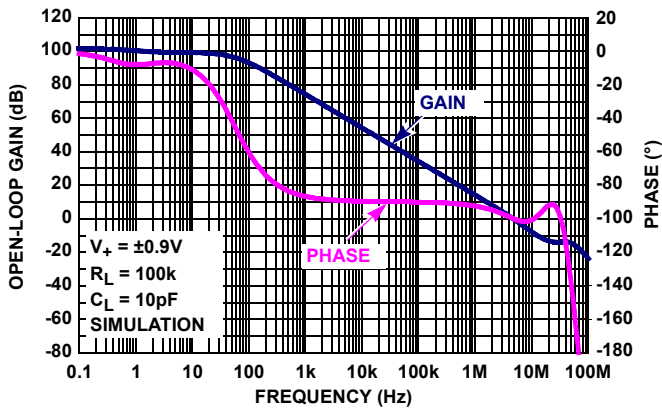

FIGURE 29. SIMULATED (DESIGN) OPEN-LOOP GAIN, PHASE vs FREQUENCY

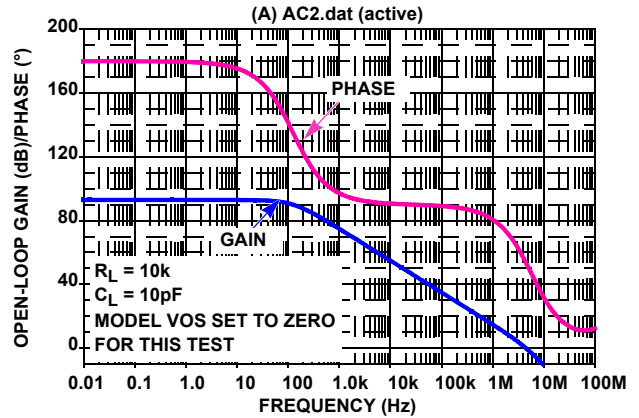

FIGURE 30. SIMULATED (SPICE) OPEN-LOOP GAIN, PHASE vs FREQUENCY

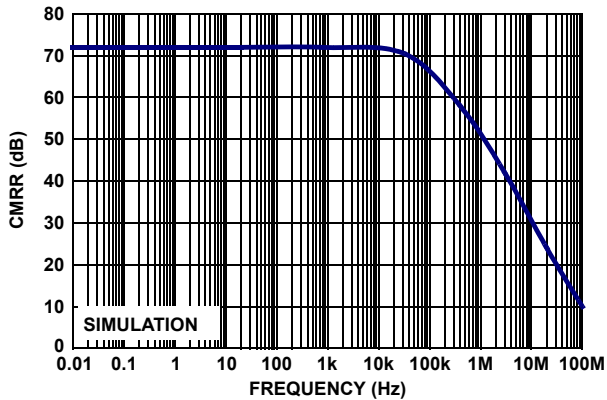

FIGURE 31. SIMULATED (DESIGN) CMRR

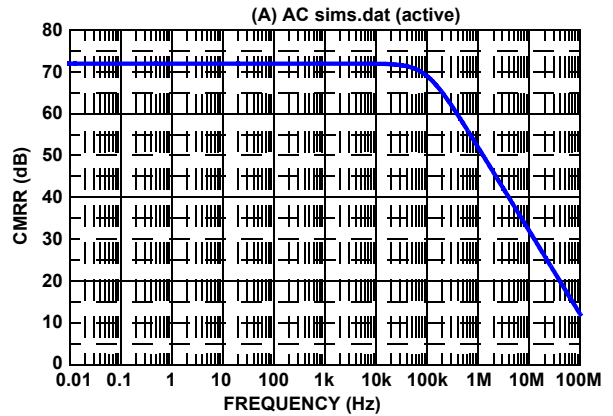

FIGURE 32. SIMULATED (SPICE) CMRR

## Revision History

The revision history provided is for informational purposes only and is believed to be accurate, but not warranted. Please visit our website to make sure you have the latest revision.

DATE	REVISION	CHANGE
December 8, 2016	FN6800.10	Updated Related Literature section. Updated third Applications bullet. Updated Ordering Information table on page 2.
June 11, 2015	FN6800.9	Electrical Spec table, page 5 - Input Noise Voltage Density (eN) added a spec at 10kHz (typical spec).
October 26, 2012	FN6800.8	Added SOT23-8 package on page 1 to description and features. Ordering Information on page 2 - Added ISL28214FHZ parts and Note 5 reference. Added Lead Finish Note to Ordering information for 8 LD SOT-23 parts. Thermal Information on page 4 - Added 8 LD SOT-23 package with Tja and Tjc Added P8.064 POD on page 23.
April 13, 2012	FN6800.7	Changed the low supply current in "Features" and description on page 1 from 360 $\mu$ A to 390 $\mu$ A. Removed ISL28114FEV1Z-T7 Coming Soon parts from "Ordering Information" on page 2. Removed applicable pinout from page 3. On page 4, changed MIN/MAX limits for "V <sub>OS</sub> " at 25 $^{\circ}$ C from -5/5mV to -4/4mV. On page 4, changed MIN/MAX limits for "V <sub>OS</sub> " at -40 $^{\circ}$ C to 125 $^{\circ}$ C from -6/6mV to -5/5mV. On page 4, changed "TCV <sub>OS</sub> " TYP from 2 $\mu$ V/ $^{\circ}$ C to 5 $\mu$ V/ $^{\circ}$ C. On page 4, changed MAX limit for "I <sub>S</sub> " MAX at 25 $^{\circ}$ C from 360 $\mu$ A to 390 $\mu$ A. On page 4, changed MAX limit for "I <sub>S</sub> " MAX at -40 $^{\circ}$ C to 125 $^{\circ}$ C from 400 $\mu$ A to 475 $\mu$ A. Revised Figure 8 on page 7. Revised Figure 11 on page 7. Revised Figure 18 on page 8.
January 3, 2012	FN6800.6	Revised "SPICE SCHEMATIC" on page 11 and "SPICE NET LIST" on page 12.
May 18, 2011	FN6800.5	- On page 3, Pin Descriptions: Circuit 3 diagram, removed anti-parallel diodes from the IN+ to IN- terminals. - On page 4, Absolute Maximum Ratings: changed Differential Input Voltage from "0.5V" to "V- - 0.5V to V+ + 0.5V" - On page 4, updated CMRR and PSRR parameters in Electrical Specifications table with test condition specifying -40 $^{\circ}$ C to 125 $^{\circ}$ C typical parameter. - On page 5, updated Note 8, referenced in MIN and MAX column headings of Electrical Specifications table, from "Parameters with MIN and/or MAX limits are 100% tested at +25 $^{\circ}$ C, unless otherwise specified. Temperature limits established by characterization and are not production tested." to new standard "Compliance to datasheet limits is assured by one or more methods: production test, characterization and/or design." - On page 9, under "Input ESD Diode Protection," removed "They also contain back-to-back diodes across the input terminals." Removed "Although the amplifier is fully protected, high input slew rates that exceed the amplifier slew rate ( $\pm$ 2.5V/ $\mu$ s) may cause output distortion." - On page 9, Figure 19: updated circuit schematic by removing back-to-back input protection diodes. - On page 11 replaced SPICE schematic (Figure 21) - On page 12 replaced SPICE Netlist (Figure 22) - On page 13 replaced Figure 24 - On page 14 replaced Figure 32

**Revision History** The revision history provided is for informational purposes only and is believed to be accurate, but not warranted. Please visit our website to make sure you have the latest revision. **(Continued)**

DATE	REVISION	CHANGE
September 23, 2010	FN6800.4	<p>Added new SC70 pinout package extension as follows:            Added to Related Literature on page 1 "See AN1547 for "ISL28414TSSOPEVAL1Z Evaluation Board User's Guide".            Added to ordering information ISL28114FEV1Z-T7 and ISL28114FEV1Z-T7A and Evaluation boards.            Added to Pin Configurations new pinout for ISL28114FEV1Z.            Added in Pin Descriptions ISL28114FEV1Z SC70 pin description column.            Changed Note 7 on page page 4 from "For <math>\theta_{JC}</math>, the "case temp" location is the center of the exposed metal pad on the package underside." to            "For <math>\theta_{JC}</math>, the "case temp" location is taken at the package top center."            Added "Related Literature" on page 1.            Changed package outline drawing from MDP0038 to P5.064A on page 2 and page 18.            MDP0038 package contained 2 packages for both the 5 and 6 Ld SOT-23. MDP0038 was obsoleted and the packages were separated and made into 2 separate package outline drawings; P5.064A and P6.064A. Changes to the 5 Ld SOT-23 were to move dimensions from table onto drawing, add land pattern and add JEDEC reference number.            Added Note 5 to "Ordering Information" on page 2.</p>
December 16, 2009	FN6800.3	<p>Removed "Coming Soon" from MSOP package options in the "Ordering Information" on page 2.            Updated the Theta JA for the MSOP package option from 170 °C/W to 180 °C/W on page 4.</p>
November 17, 2009	FN6800.2	<p>Removed "Coming Soon" from SC70 and SOT-23 package options in the "Ordering Information" on page 2.</p>
November 12, 2009	FN6800.1	<p>Changed theta Ja to 250 from 300. Added license statement (page 10) and reference in spice model (page 12).</p>
October 23, 2009	FN6800.0	Initial Release

## About Intersil

Intersil Corporation is a leading provider of innovative power management and precision analog solutions. The company's products address some of the largest markets within the industrial and infrastructure, mobile computing, and high-end consumer markets.

For the most updated datasheet, application notes, related documentation, and related parts, please see the respective product information page found at [www.intersil.com](http://www.intersil.com).

You may report errors or suggestions for improving this datasheet by visiting [www.intersil.com/ask](http://www.intersil.com/ask).

Reliability reports are also available from our website at [www.intersil.com/support](http://www.intersil.com/support).



# Small Outline Transistor Plastic Packages (SC70-5)

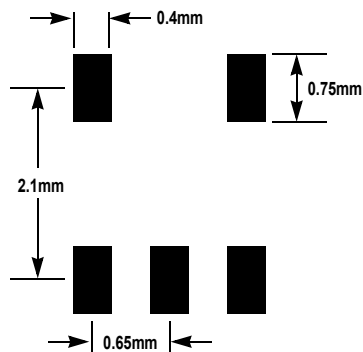
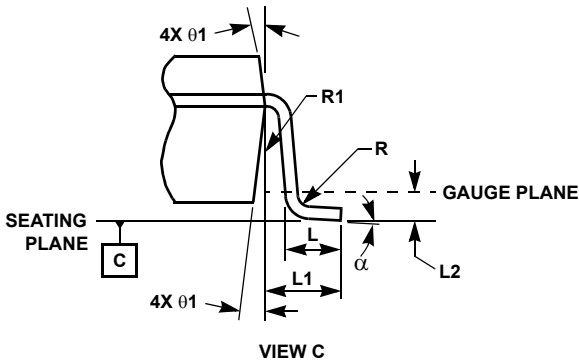
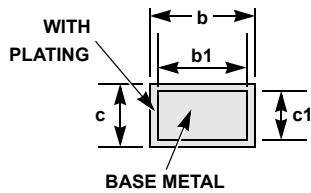
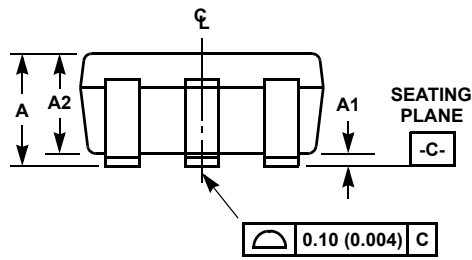
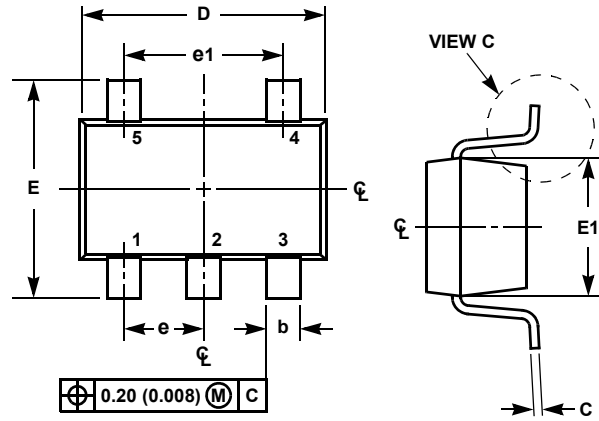

TYPICAL RECOMMENDED LAND PATTERN

## P5.049

### 5 LEAD SMALL OUTLINE TRANSISTOR PLASTIC PACKAGE

SYMBOL	INCHES		MILLIMETERS		NOTES
	MIN	MAX	MIN	MAX	
A	0.031	0.043	0.80	1.10	-
A1	0.000	0.004	0.00	0.10	-
A2	0.031	0.039	0.80	1.00	-
b	0.006	0.012	0.15	0.30	-
b1	0.006	0.010	0.15	0.25	-
c	0.003	0.009	0.08	0.22	6
c1	0.003	0.009	0.08	0.20	6
D	0.073	0.085	1.85	2.15	3
E	0.071	0.094	1.80	2.40	-
E1	0.045	0.053	1.15	1.35	3
e	0.0256 Ref		0.65 Ref		-
e1	0.0512 Ref		1.30 Ref		-
L	0.010	0.018	0.26	0.46	4
L1	0.017 Ref.		0.420 Ref.		-
L2	0.006 BSC		0.15 BSC		-
α	0°	8°	0°	8°	-
N	5		5		5
R	0.004	-	0.10	-	-
R1	0.004	0.010	0.15	0.25	-

Rev. 3 7/07

#### NOTES:

1. Dimensioning and tolerances per ASME Y14.5M-1994.
2. Package conforms to EIAJ SC70 and JEDEC MO-203AA.
3. Dimensions D and E1 are exclusive of mold flash, protrusions, or gate burrs.
4. Footlength L measured at reference to gauge plane.
5. "N" is the number of terminal positions.
6. These Dimensions apply to the flat section of the lead between 0.08mm and 0.15mm from the lead tip.
7. Controlling dimension: MILLIMETER. Converted inch dimensions are for reference only.

For the most recent package outline drawing, see [P5.049](#).



# Package Outline Drawing

## M8.118A

For the most recent package outline drawing, see [M8.118A](#).

8 LEAD MINI SMALL OUTLINE PLASTIC PACKAGE (MSOP)  
 Rev 0, 9/09

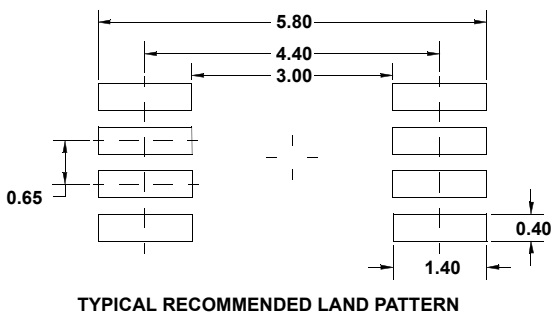
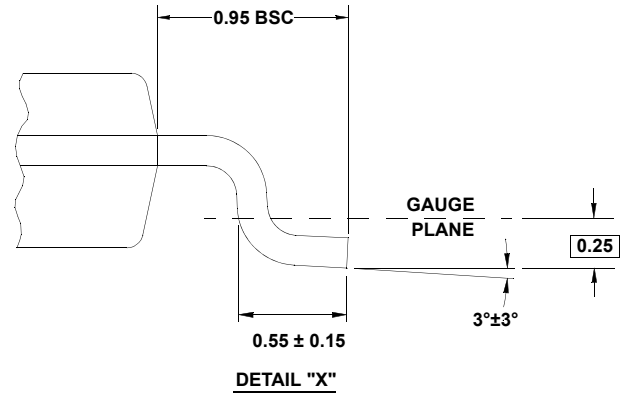
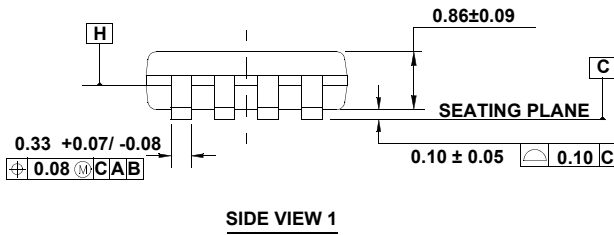
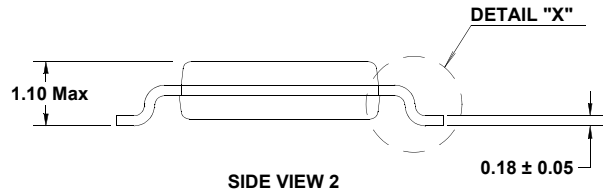
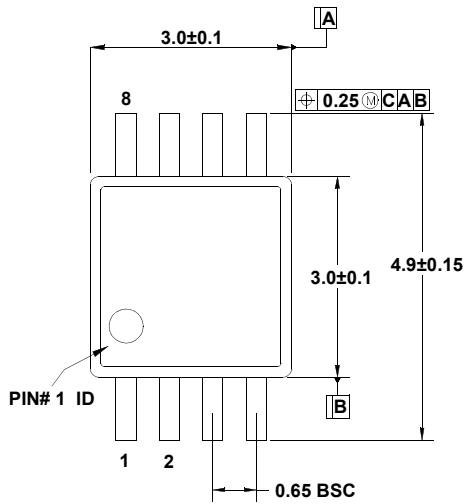

NOTES:

1. Dimensions are in millimeters.
2. Dimensioning and tolerancing conform to JEDEC MO-187-AA and AMSE Y14.5m-1994.
3. Plastic or metal protrusions of 0.15mm max per side are not included.
4. Plastic interlead protrusions of 0.25mm max per side are not included.
5. Dimensions "D" and "E1" are measured at Datum Plane "H".
6. This replaces existing drawing # MDP0043 MSOP 8L.

# Package Outline Drawing

## M8.15E

For the most recent package outline drawing, see [M8.15E](#).

8 LEAD NARROW BODY SMALL OUTLINE PLASTIC PACKAGE  
Rev 0, 08/09

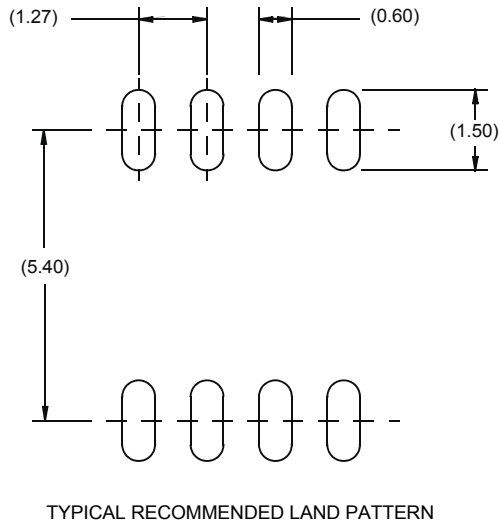
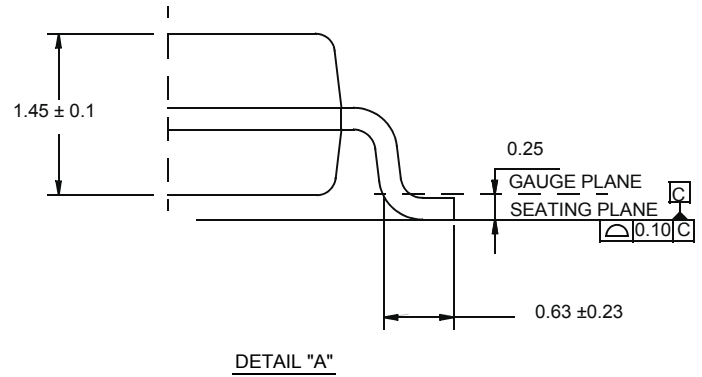
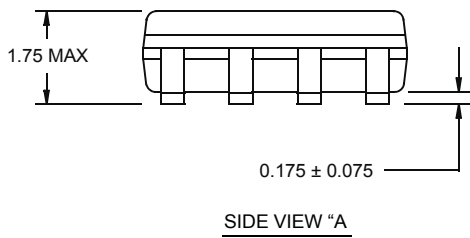
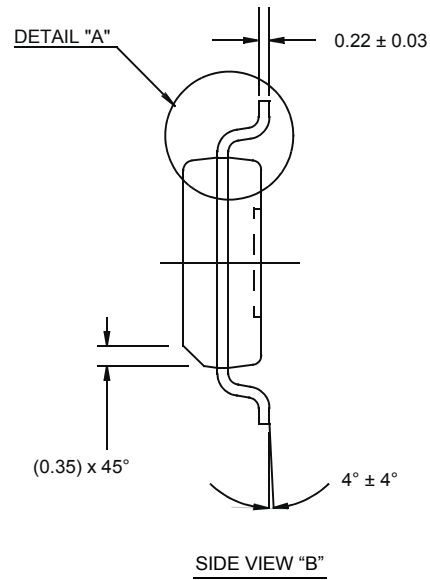
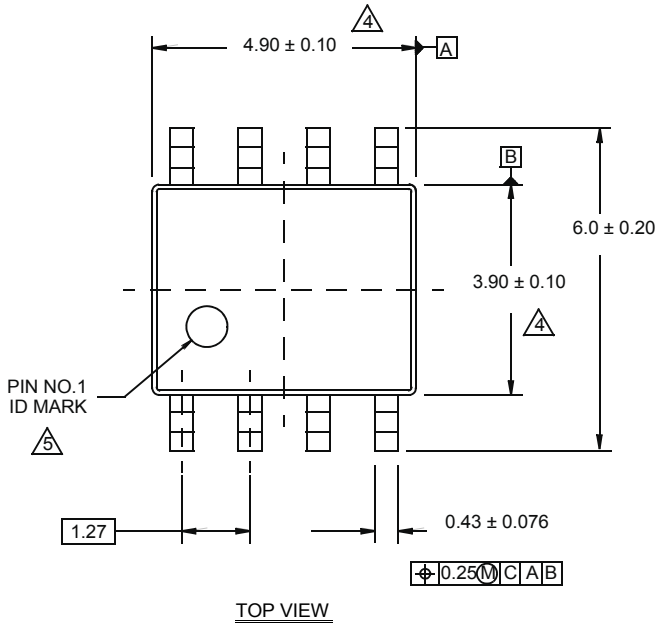

**NOTES:**

1. Dimensions are in millimeters.  
Dimensions in ( ) for Reference Only.
2. Dimensioning and tolerancing conform to AMSE Y14.5m-1994.
3. Unless otherwise specified, tolerance : Decimal ± 0.05
4. Dimension does not include interlead flash or protrusions.  
Interlead flash or protrusions shall not exceed 0.25mm per side.
5. The pin #1 identifier may be either a mold or mark feature.
6. Reference to JEDEC MS-012.

# Small Outline Package Family (SO)

For the most recent package outline drawing, see [MDP0027](#).

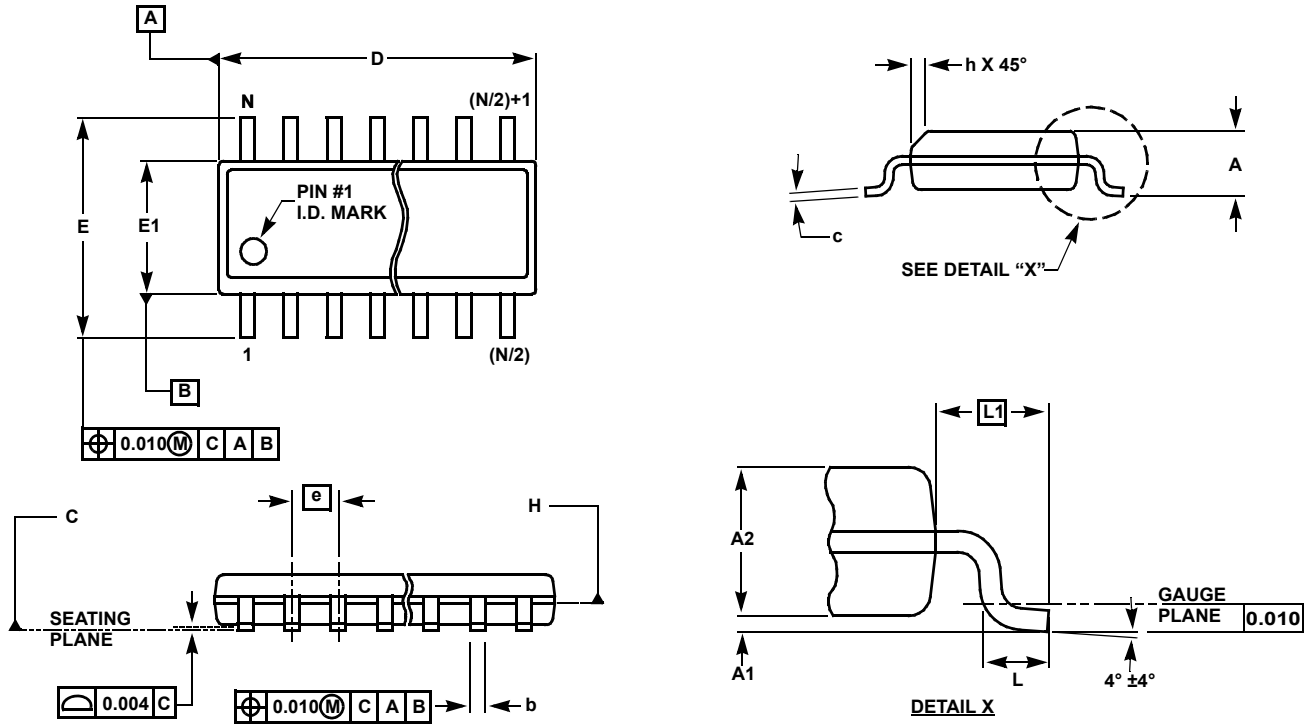

## MDP0027

### SMALL OUTLINE PACKAGE FAMILY (SO)

SYMBOL	INCHES							TOLERANCE	NOTES
	SO-8	SO-14	SO16 (0.150")	SO16 (0.300") (SOL-16)	SO20 (SOL-20)	SO24 (SOL-24)	SO28 (SOL-28)		
A	0.068	0.068	0.068	0.104	0.104	0.104	0.104	MAX	-
A1	0.006	0.006	0.006	0.007	0.007	0.007	0.007	±0.003	-
A2	0.057	0.057	0.057	0.092	0.092	0.092	0.092	±0.002	-
b	0.017	0.017	0.017	0.017	0.017	0.017	0.017	±0.003	-
c	0.009	0.009	0.009	0.011	0.011	0.011	0.011	±0.001	-
D	0.193	0.341	0.390	0.406	0.504	0.606	0.704	±0.004	1, 3
E	0.236	0.236	0.236	0.406	0.406	0.406	0.406	±0.008	-
E1	0.154	0.154	0.154	0.295	0.295	0.295	0.295	±0.004	2, 3
e	0.050	0.050	0.050	0.050	0.050	0.050	0.050	Basic	-
L	0.025	0.025	0.025	0.030	0.030	0.030	0.030	±0.009	-
L1	0.041	0.041	0.041	0.056	0.056	0.056	0.056	Basic	-
h	0.013	0.013	0.013	0.020	0.020	0.020	0.020	Reference	-
N	8	14	16	16	20	24	28	Reference	-

Rev. M 2/07

NOTES:

1. Plastic or metal protrusions of 0.006" maximum per side are not included.
2. Plastic interlead protrusions of 0.010" maximum per side are not included.
3. Dimensions "D" and "E1" are measured at Datum Plane "H".
4. Dimensioning and tolerancing per ASME Y14.5M-1994

# Thin Shrink Small Outline Package Family (TSSOP)

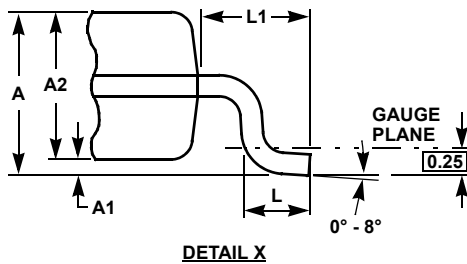
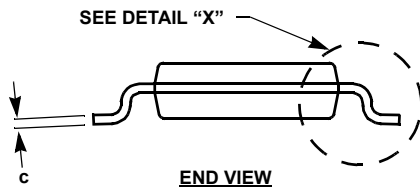
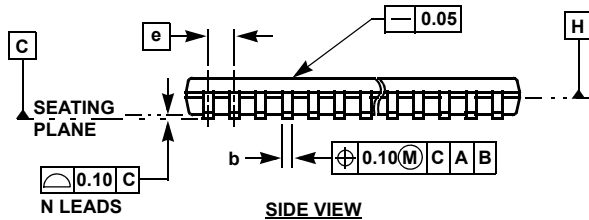
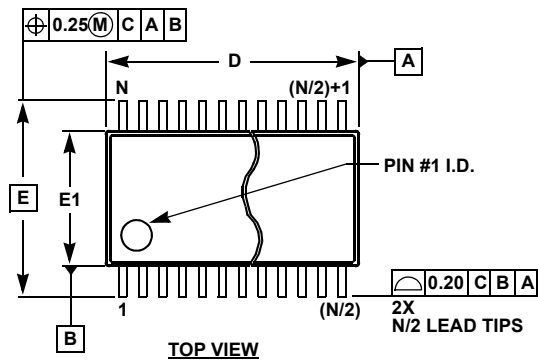

## MDP0044

### THIN SHRINK SMALL OUTLINE PACKAGE FAMILY

SYMBOL	MILLIMETERS					TOLERANCE
	14 LD	16 LD	20 LD	24 LD	28 LD	
A	1.20	1.20	1.20	1.20	1.20	Max
A1	0.10	0.10	0.10	0.10	0.10	±0.05
A2	0.90	0.90	0.90	0.90	0.90	±0.05
b	0.25	0.25	0.25	0.25	0.25	+0.05/-0.06
c	0.15	0.15	0.15	0.15	0.15	+0.05/-0.06
D	5.00	5.00	6.50	7.80	9.70	±0.10
E	6.40	6.40	6.40	6.40	6.40	Basic
E1	4.40	4.40	4.40	4.40	4.40	±0.10
e	0.65	0.65	0.65	0.65	0.65	Basic
L	0.60	0.60	0.60	0.60	0.60	±0.15
L1	1.00	1.00	1.00	1.00	1.00	Reference

Rev. F 2/07

#### NOTES:

1. Dimension "D" does not include mold flash, protrusions or gate burrs. Mold flash, protrusions or gate burrs shall not exceed 0.15mm per side.
2. Dimension "E1" does not include interlead flash or protrusions. Interlead flash and protrusions shall not exceed 0.25mm per side.
3. Dimensions "D" and "E1" are measured at dAtum Plane H.
4. Dimensioning and tolerancing per ASME Y14.5M-1994.

For the most recent package outline drawing, see [MDP0044](#).