

ISL55110, ISL55111

Dual, High Speed MOSFET Driver

FN6228
Rev 9.0
Apr 29, 2021

The [ISL55110](#) and [ISL55111](#) are dual high speed MOSFET drivers intended for applications requiring accurate pulse generation and buffering. Target applications include ultrasound, CCD imaging, piezoelectric distance sensing and clock generation circuits.

With a wide output voltage range and low ON-resistance, these devices can drive a variety of resistive and capacitive loads with fast rise and fall times, allowing high-speed operation with low skew, as required in large CCD array imaging applications.

The ISL55110, ISL55111 are compatible with 3.3V and 5V logic families and incorporate tightly controlled input thresholds to minimize the effect of input rise time on output pulse width. The ISL55110 has a pair of in-phase drivers while the ISL55111 has two drivers operating in anti-phase.

ISL55110 and ISL55111 have a power-down mode for low power consumption during equipment standby times, making it ideal for portable products.

The ISL55110 and ISL55111 are available in 16 Ld Exposed pad QFN packaging and 8 Ld TSSOP. Both devices are specified for operation over the full -40°C to +85°C temperature range.

Features

- 5V to 12V pulse amplitude
- High current drive 3.5A
- 6ns minimum pulse width
- 1.5ns rise and fall times, 100pF load
- Low skew
- 3.3V and 5V logic compatible
- In-phase (ISL55110) and anti-phase outputs (ISL55111)
- Small QFN and TSSOP packaging
- Low quiescent current
- Pb-free (RoHS compliant)

Applications

- Ultrasound MOSFET driver
- CCD array horizontal driver
- Clock driver circuits

ISL55110 AND ISL55111 DUAL DRIVER

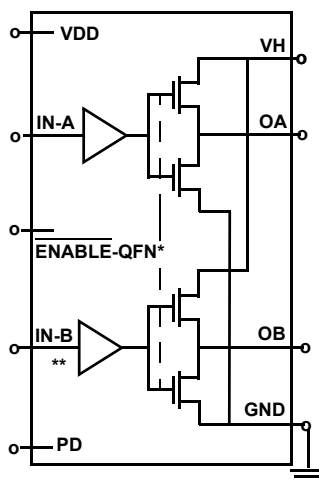

*ENABLE AVAILABLE IN QFN PACKAGE ONLY

**ISL55111 IN-B IS INVERTING

FIGURE 1. FUNCTIONAL BLOCK DIAGRAM

Pin Configurations

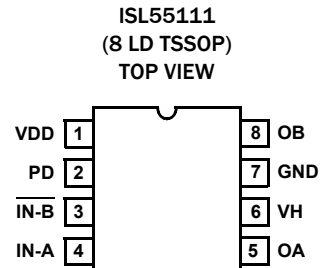
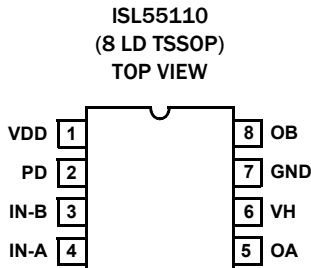
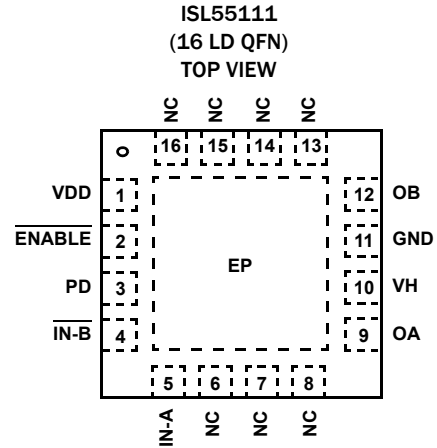
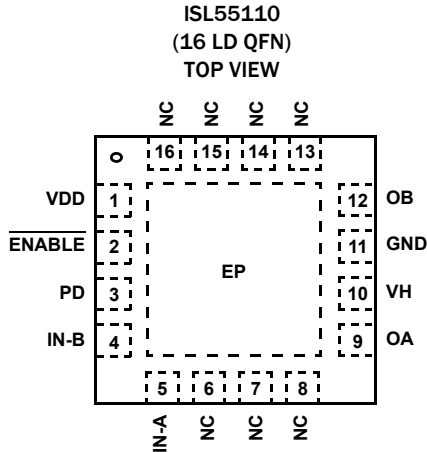

Pin Descriptions

16 LD QFN	8 LD TSSOP	PIN	FUNCTION
1	1	VDD	Logic power.
10	6	VH	Driver high rail supply.
11	7	GND	Ground, return for both VH rail and VDD logic supply. This is also the potential of the QFN's exposed pad (EP).
3	2	PD	Power-down. Active logic high places part in power-down mode.
2	-	ENABLE	QFN packages only. When the $\overline{\text{ENABLE}}$ pin is low, the device will operate normally (outputs controlled by the inputs). When the $\overline{\text{ENABLE}}$ pin is tied high, the output will be tri-stated. In other words, it will act as if it is open or floating regardless of what is on the IN-x pins. This provides high-speed enable control over the driver outputs.
5	4	IN-A	Logic level input that drives OA to VH rail or ground. Not inverted.
4	3	IN-B, $\overline{\text{IN-B}}$	Logic level input that drives OB to VH rail or ground. Not inverted on ISL55110, inverted on ISL55111.
9	5	OA	Driver output related to IN-A.
12	8	OB	Driver output related to IN-B.
6, 7, 8, 13, 14, 15, 16	-	NC	No internal connection.
EP	-	EP	Exposed thermal pad. Connect to GND and follow good thermal pad layout guidelines.

Ordering Information

PART NUMBER (Notes 2, 3)	PART MARKING	PACKAGE DESCRIPTION (RoHS Compliant)	PKG. DWG. #	CARRIER TYPE (Note 1)	TEMP. RANGE
ISL55110IRZ	55110IRZ	16 Ld QFN	L16.4x4A	Tube	-40 to +85 °C
ISL55110IRZ-T				Reel, 6k	
ISL55110IRZ-T7A				Reel, 250	
ISL55110IVZ	55110 IVZ	8 Ld TSSOP	M8.173	Tube	
ISL55110IVZ-T				Reel, 2.5k	
ISL55110IVZ-T7A				Reel, 250	
ISL55111IRZ	55111IRZ	16 Ld QFN	L16.4x4A	Tube	
ISL55111IRZ-T				Reel, 6k	
ISL55111IVZ	55111 IVZ	8 Ld TSSOP	M8.173	Tube	
ISL55111IVZ-T				Reel, 2.5k	
ISL55110EVAL1Z	TSSOP Evaluation Board				
ISL55110EVAL2Z	QFN Evaluation Board				
ISL55111EVAL1Z	TSSOP Evaluation Board				
ISL55111EVAL2Z	QFN Evaluation Board				

NOTES:

1. See [TB347](#) for details about reel specifications.
2. These Pb-free plastic packaged products employ special Pb-free material sets, molding compounds/die attach materials and 100% matte tin plate plus anneal (e3 termination finish, which is RoHS compliant and compatible with both SnPb and Pb-free soldering operations). Pb-free products are MSL classified at Pb-free peak reflow temperatures that meet or exceed the Pb-free requirements of IPC/JEDEC J STD-020.
3. For Moisture Sensitivity Level (MSL), see the device information pages for [ISL55110](#) and [ISL55111](#). For more information about MSL, see [TB363](#).

Absolute Maximum Ratings ($T_A = +25^\circ\text{C}$)

V_H to GND	14.0V
V_{DD} to GND	6.5V
VIN-A, VIN-B, PD, $\overline{\text{ENABLE}}$	(GND - 0.5V) to ($V_{DD} + 0.5V$)
OA, OB	(GND - 0.5) to ($V_H + 0.5V$)
Maximum Peak Output Current	300mA
ESD Rating	
Human Body Model	3kV

Thermal Information

Thermal Resistance	θ_{JA} ($^\circ\text{C}/\text{W}$)	θ_{JC} ($^\circ\text{C}/\text{W}$)
16 Ld (4x4) QFN Package (Notes 5, 6) ...	45	3.0
8 Ld TSSOP Package (Notes 4, 7) ...	140	46
Maximum Junction Temperature (Plastic Package)	+150 $^\circ\text{C}$	
Maximum Storage Temperature Range	-65 $^\circ\text{C}$ to +150 $^\circ\text{C}$	
Pb-free reflow profile	see TB493	

Recommended Operating Conditions

Temperature Range	-40 $^\circ\text{C}$ to +85 $^\circ\text{C}$
Drive Supply Voltage (V_H)	5V to 13.2V
Logic Supply Voltage (V_{DD})	2.7V to 5.5V
Ambient Temperature (T_A)	-40 $^\circ\text{C}$ to +85 $^\circ\text{C}$
Junction Temperature (T_J)	+150 $^\circ\text{C}$

CAUTION: Do not operate at or near the maximum ratings listed for extended periods of time. Exposure to such conditions may adversely impact product reliability and result in failures not covered by warranty.

NOTES:

- θ_{JA} is measured with the component mounted on a high-effective thermal conductivity test board in free air. See [TB379](#) for details.
- θ_{JA} is measured in free air with the component mounted on a high effective thermal conductivity test board with direct attach features. See [TB379](#).
- For θ_{JC} , the case temperature location is the center of the exposed metal pad on the package underside.
- For θ_{JC} , the case temperature location is taken at the package top center.

IMPORTANT NOTE: All parameters having Min/Max specifications are guaranteed. Typical values are for information purposes only. Unless otherwise noted, all tests are at the specified temperature and are pulsed tests, therefore: $T_J = T_C = T_A$

DC Electrical Specifications $V_H = +12V$, $V_{DD} = 2.7V$ to $5.5V$, $T_A = +25^\circ\text{C}$, unless otherwise specified.

PARAMETER	DESCRIPTION	TEST CONDITIONS	MIN (Note 8)	TYP	MAX (Note 8)	UNITS
LOGIC CHARACTERISTICS						
VIX_LH	Logic Input Threshold - Low-to-High	$I_{IH} = 1\mu\text{A}$: VIN-A, VIN-B	1.32	1.42	1.52	V
VIX_HL	Logic Input Threshold - High-to-Low	$I_{IL} = 1\mu\text{A}$: VIN-A, VIN-B	1.12	1.22	1.32	V
VHYS	Logic Input Hysteresis	VIN-A, VIN-B		0.2		V
VIH	Logic Input High Threshold	PD	2.0		VDD	V
VIL	Logic Input Low Threshold	PD	0		0.8	V
VIH	Logic Input High Threshold	$\overline{\text{ENABLE}}$ - QFN only	2.0		VDD	V
VIL	Logic Input Low Threshold	$\overline{\text{ENABLE}}$ - QFN only	0		0.8	V
IIX_H	Input Current Logic High	VIN-A, VIN-B = VDD		10	20	nA
IIX_L	Input Current Logic Low	VIN-A, VIN-B = 0V		10	20	nA
II_H	Input Current Logic High	PD = VDD		10	20	nA
II_L	Input Current Logic Low	PD = 0V		10	15	nA
II_H	Input Current Logic High	$\overline{\text{ENABLE}} = \text{VDD}$ (QFN only)			12	μA
II_L	Input Current Logic Low	$\overline{\text{ENABLE}} = 0V$ (QFN only)	-25			nA
DRIVER CHARACTERISTICS						
r_{DS}	Driver Output Resistance	OA, OB		3	6	Ω
I_{DC}	Driver Output DC Current (>2s)			100		mA
I_{AC}	Peak Output Current	Design Intent; verified via simulation.		3.5		A
VOH to VOL	Driver Output Swing Range	OA or OB = "1", voltage referenced to GND	3		13.2	V

DC Electrical Specifications $V_H = +12V$, $V_{DD} = 2.7V$ to $5.5V$, $T_A = +25^\circ C$, unless otherwise specified. (Continued)

PARAMETER	DESCRIPTION	TEST CONDITIONS	MIN (Note 8)	TYP	MAX (Note 8)	UNITS
SUPPLY CURRENTS						
I_{DD}	Logic Supply Quiescent Current	PD = Low		4.0	6.0	mA
I_{DD-PDN}	Logic Supply Power-down Current	PD = High			12	μA
IH	Driver Supply Quiescent Current	PD = Low, outputs unloaded			15	μA
IH_PDN	Driver Supply Power-down Current	PD = High			2.5	μA

AC Electrical Specifications $V_H = +12V$, $V_{DD} = +3.6V$, $T_A = +25^\circ C$, unless otherwise specified.

PARAMETER	DESCRIPTION	TEST CONDITIONS	MIN (Note 8)	TYP	MAX (Note 8)	UNITS
SWITCHING CHARACTERISTICS						
t_R	Driver Rise Time	Figure 2, OA, OB: CL = 100pF/1k 10% to 90%, VOH - VOL = 12V		1.2		ns
t_F	Driver Fall Time	Figure 2, OA, OB: CL = 100pF/1k 10% to 90%, VOH - VOL = 12V		1.4		ns
t_R	Driver Rise Time	Figure 2, OA, OB: CL = 1nF 10% to 90%, VOH - VOL = 12V		6.2		ns
t_F	Driver Fall Time	Figure 2, OA, OB: CL = 1nF 10% to 90%, VOH - VOL = 12V		6.9		ns
tpdR	Input to Output Propagation Delay	Figure 3, load 100pF/1k		10.9		ns
tpdF	Input to Output Propagation Delay			10.7		ns
tpdR	Input to Output Propagation Delay	Figure 3, load 330pF		12.8		ns
tpdF	Input to Output Propagation Delay			12.5		ns
tpdR	Input to Output Propagation Delay	Figure 3, load 680pF		14.5		ns
tpdF	Input to Output Propagation Delay			14.1		ns
tSkewR	Channel-to-Channel tpdR Spread with Same Loads Both Channels	Figure 3, All loads		<0.5		ns
tSkewF	Channel-to-Channel tpdF Spread with Same Loads Both Channels	Figure 3, All loads		<0.5		ns
FMAX	Maximum Operating Frequency		70			MHz
TMIN	Minimum Pulse Width		6			ns
PD _{EN}	Power-down to Power-on Time			650		ns
PD _{DIS}	Power-on to Power-down Time			40		ns
t _{EN}	Enable time; \overline{ENABLE} switched high to low.			40		ns
t _{DIS}	Disable time; \overline{ENABLE} switched low to high.			40		ns

NOTE:

8. Compliance to datasheet limits is assured by one or more methods: production test, characterization and/or design.

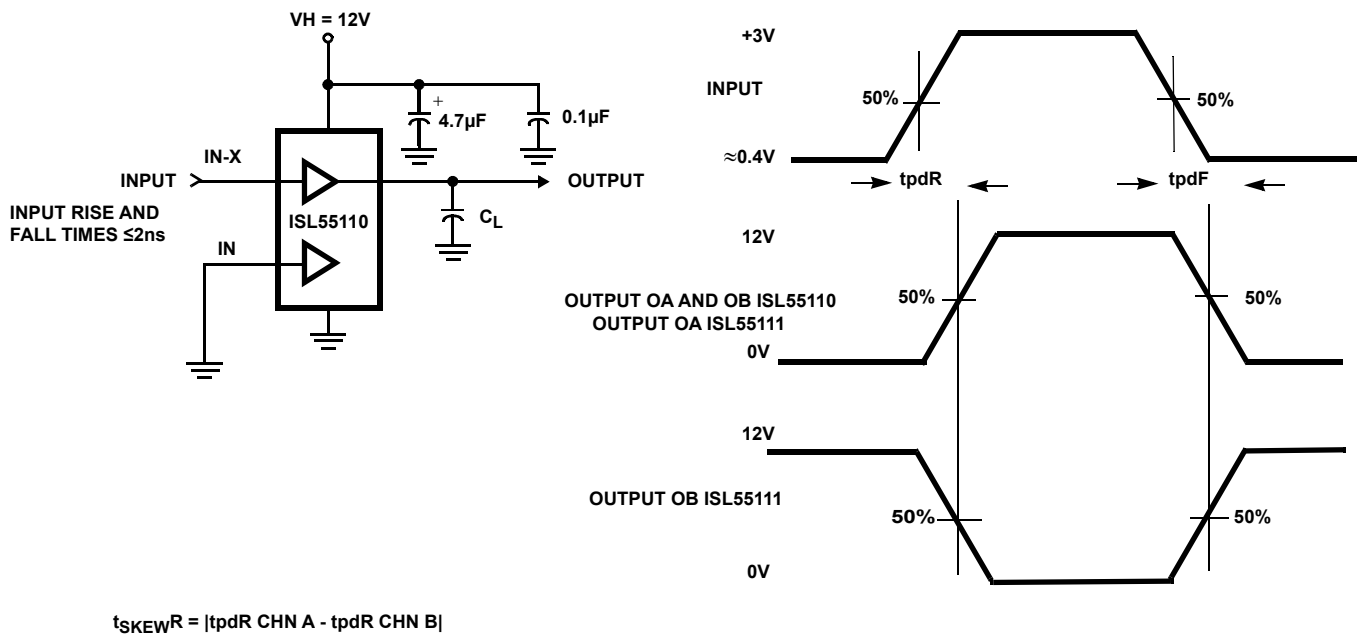
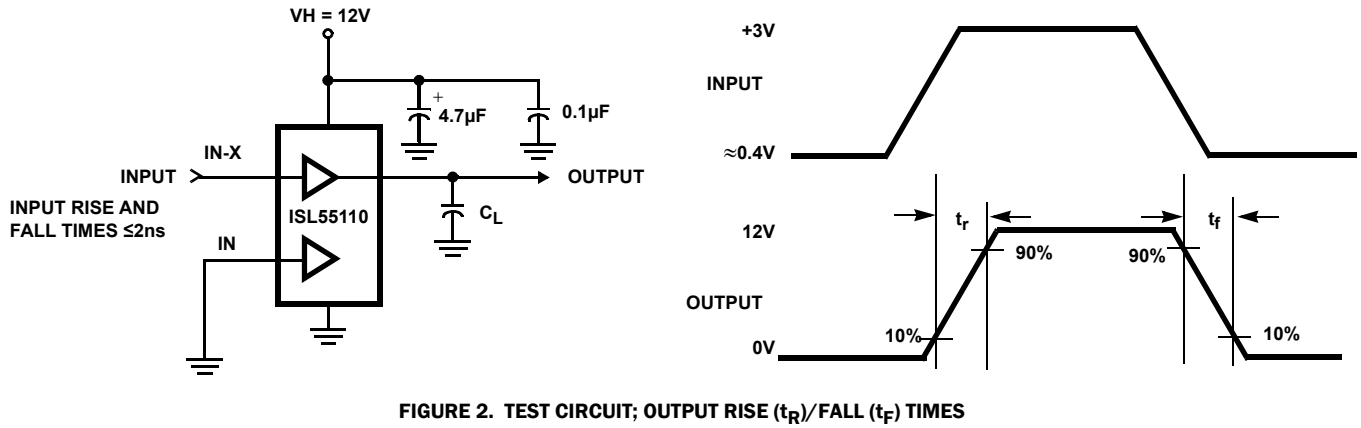

Typical Performance Curves (See ["Typical Performance Curves Discussion"](#) on page 1.1)

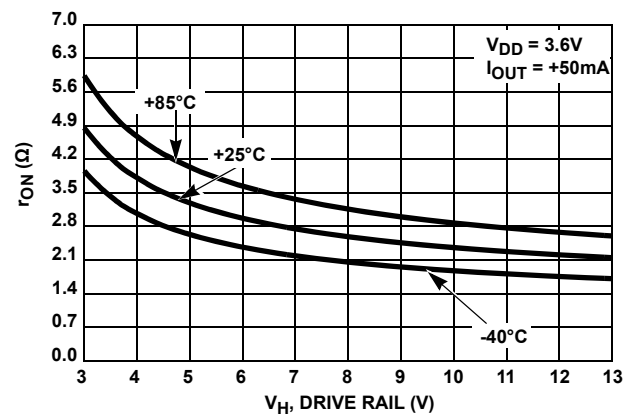
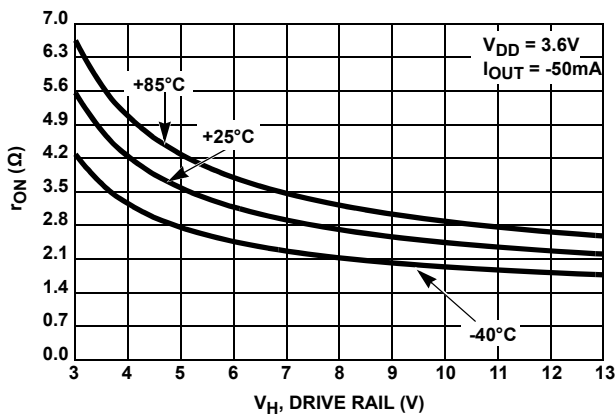

Typical Performance Curves (See [“Typical Performance Curves Discussion”](#) on page 1.1) (Continued)

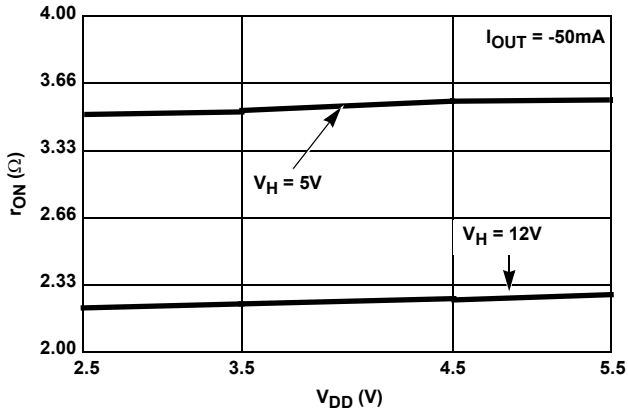

FIGURE 6. r_{ON} vs V_{DD} VOLTAGE (SOURCING CURRENT)

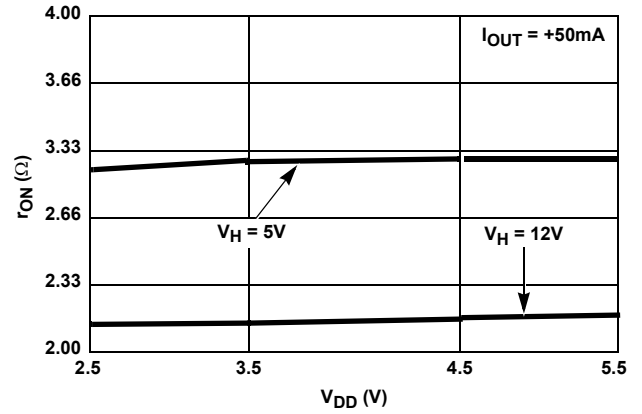

FIGURE 7. r_{ON} vs V_{DD} VOLTAGE (SINKING CURRENT)

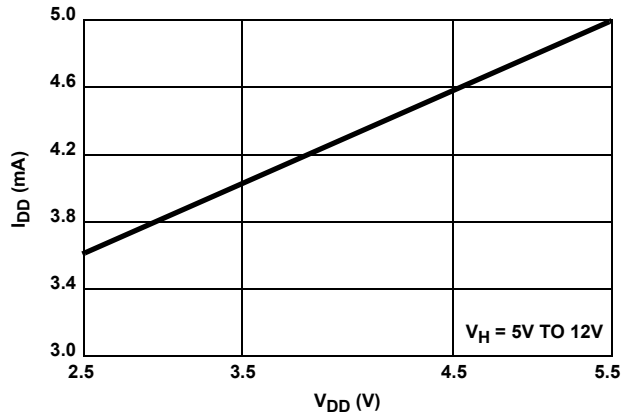

FIGURE 8. QUIESCENT I_{DD} vs V_{DD}

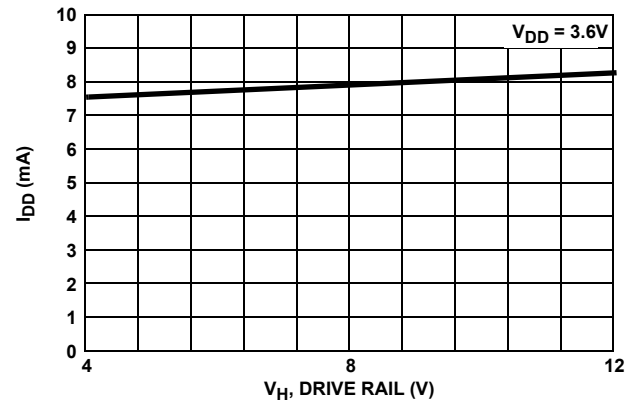

FIGURE 9. OPERATING I_{DD} vs V_H AT 50MHz (NO LOAD)

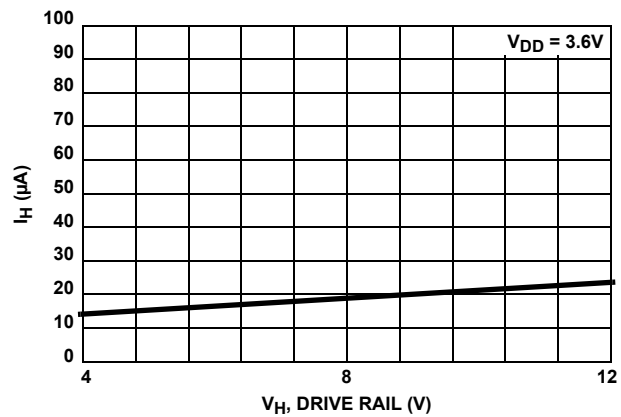

FIGURE 10. QUIESCENT I_H vs V_H

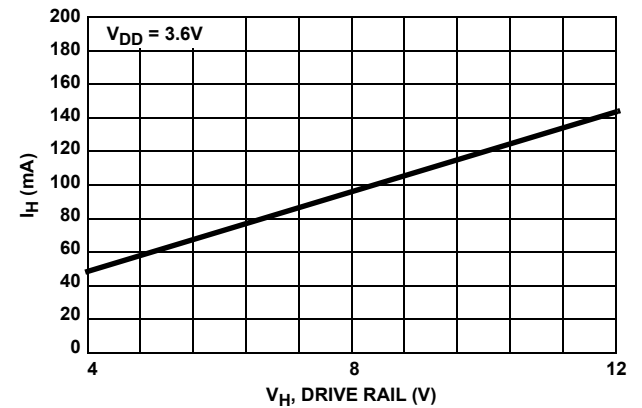

FIGURE 11. OPERATING I_H vs V_H AT 50MHz (NO LOAD)

Typical Performance Curves (See "Typical Performance Curves Discussion" on page 1.1) (Continued)

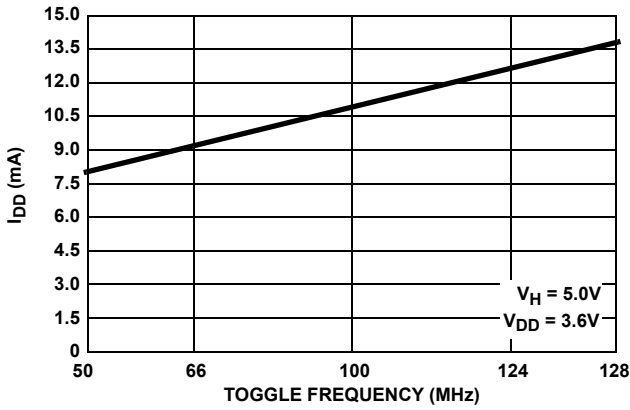

FIGURE 12. I_{DD} vs FREQUENCY (DUAL CHANNEL, NO LOAD)

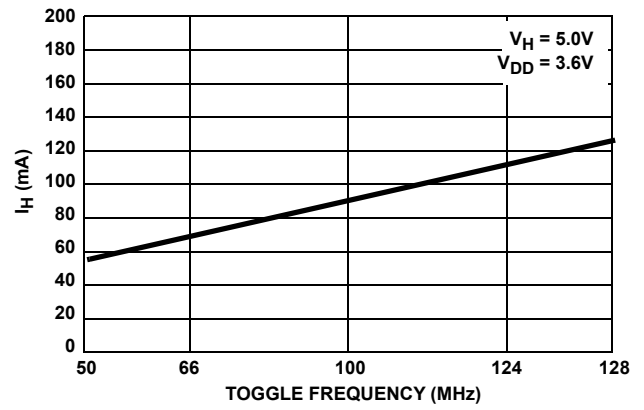

FIGURE 13. I_H vs FREQUENCY (DUAL CHANNEL, NO LOAD)



FIGURE 14. V_{IH} LOGIC THRESHOLDS vs V_{DD}

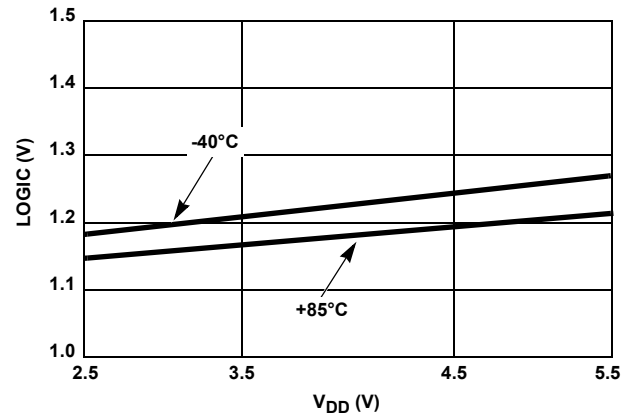

FIGURE 15. V_{IL} LOGIC THRESHOLDS vs V_{DD}

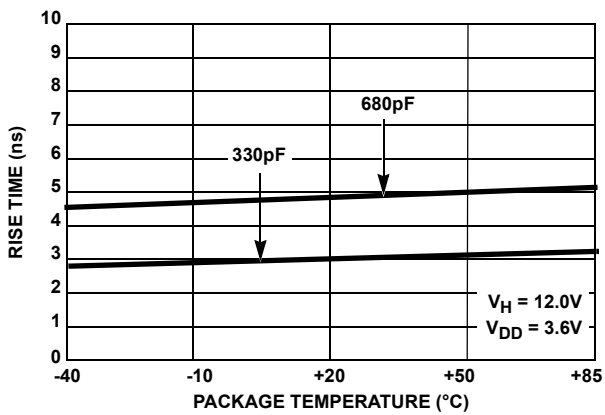

FIGURE 16. t_R vs TEMPERATURE

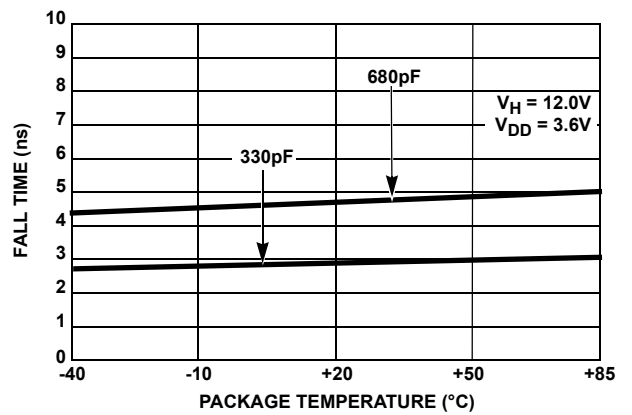

FIGURE 17. t_F vs TEMPERATURE

Typical Performance Curves (See "Typical Performance Curves Discussion" on page 1.1) (Continued)

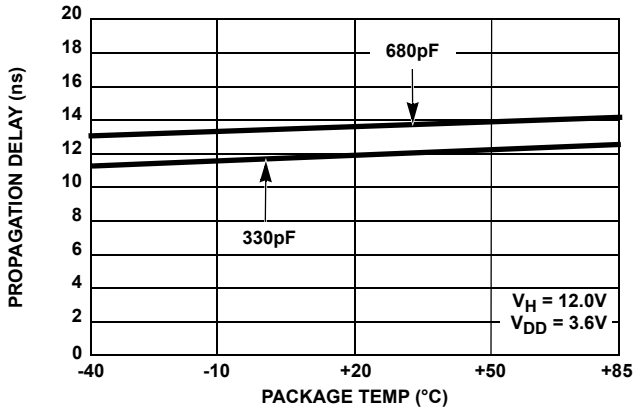

FIGURE 18. t_{pDR} vs TEMPERATURE

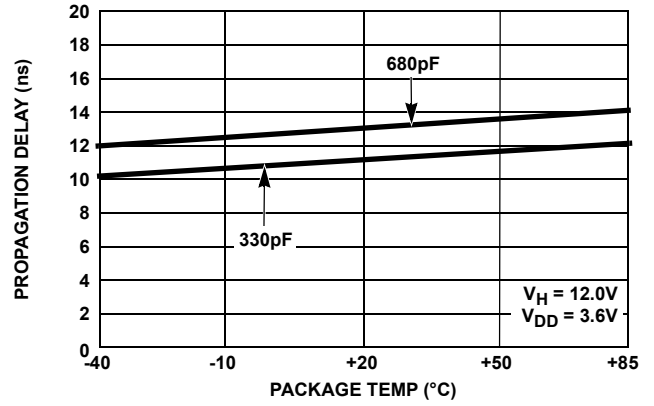

FIGURE 19. t_{pDF} vs TEMPERATURE

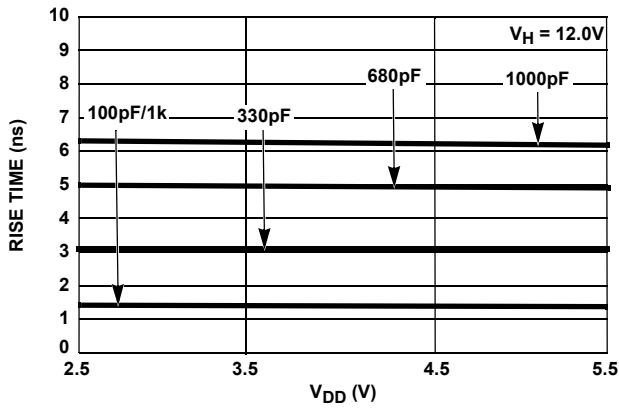

FIGURE 20. t_R vs V_{DD}

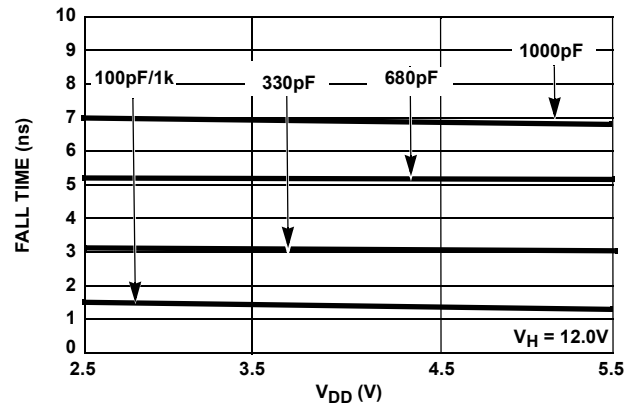

FIGURE 21. t_F vs V_{DD}

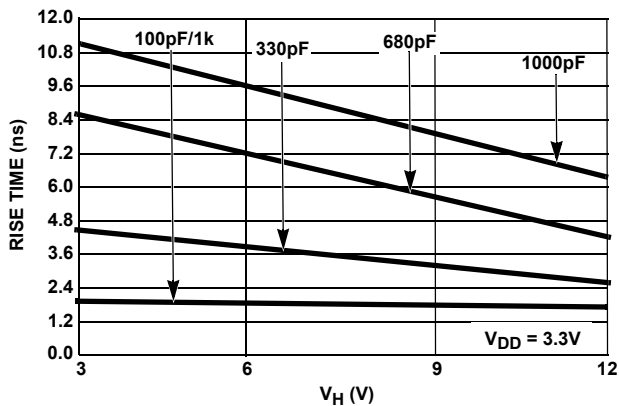

FIGURE 22. t_R vs V_H

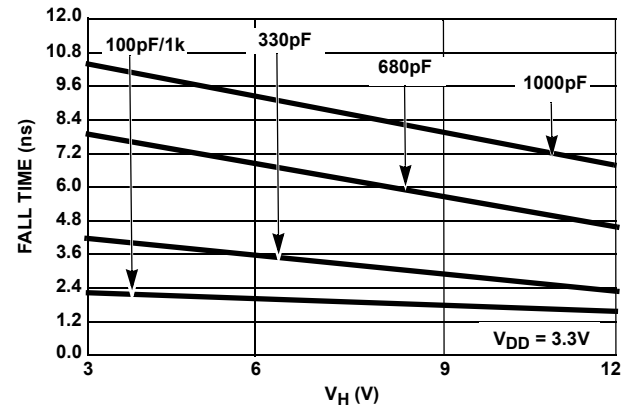

FIGURE 23. t_F vs V_H

Typical Performance Curves (See "Typical Performance Curves Discussion" on page 11) (Continued)

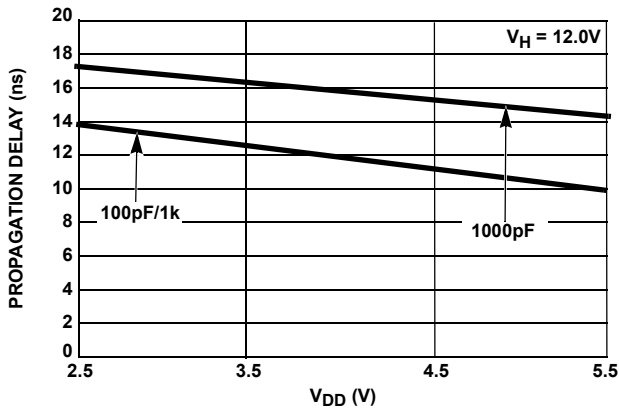

FIGURE 24. tpdR vs V_{DD}

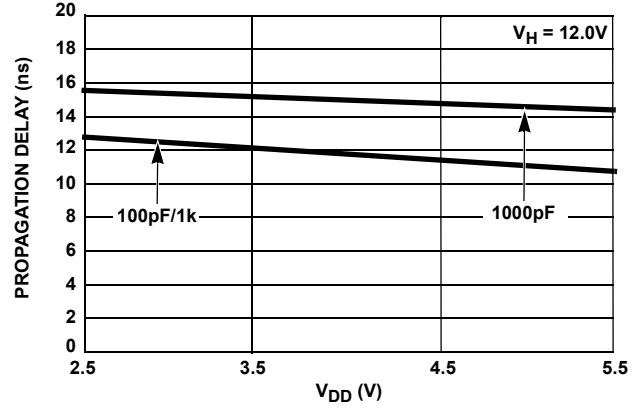

FIGURE 25. tpdF vs V_{DD}

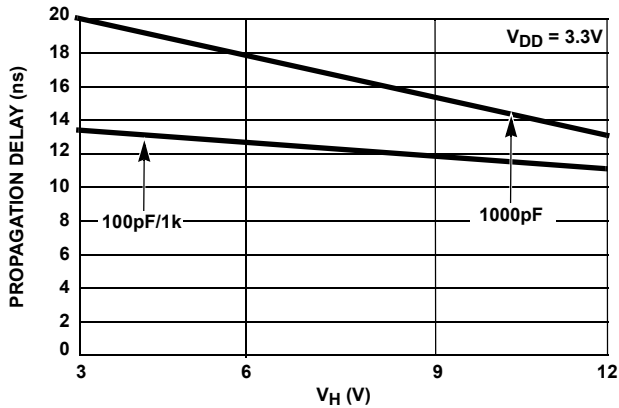

FIGURE 26. tpdR vs V_H

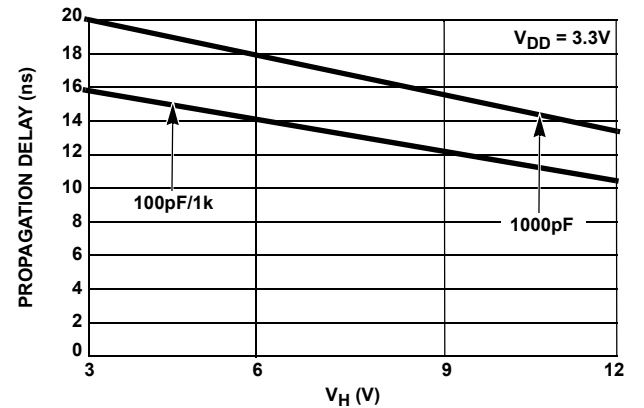

FIGURE 27. tpdF vs V_H

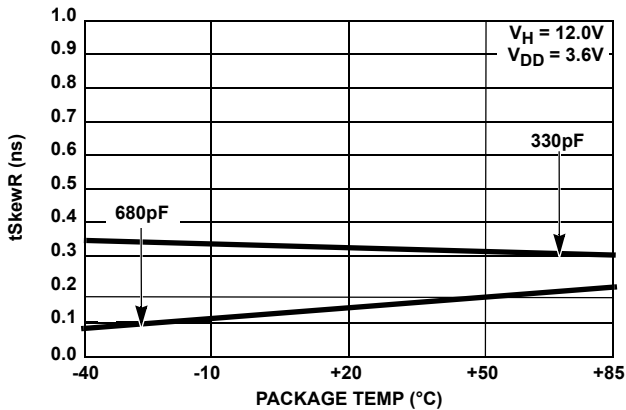

FIGURE 28. tSkewR vs TEMPERATURE

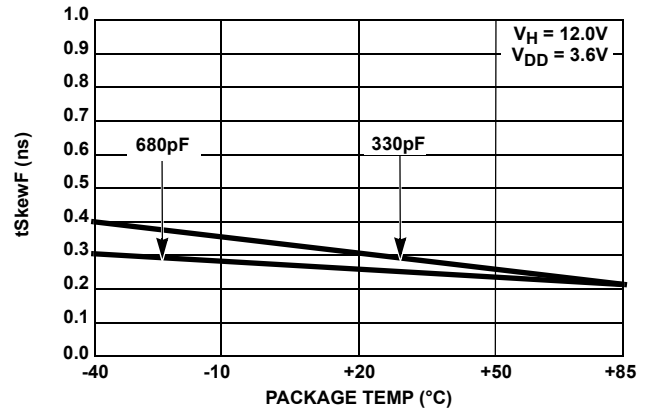

FIGURE 29. tSkewF vs TEMPERATURE

Typical Performance Curves (See [“Typical Performance Curves Discussion”](#) on page 1.1) (Continued)

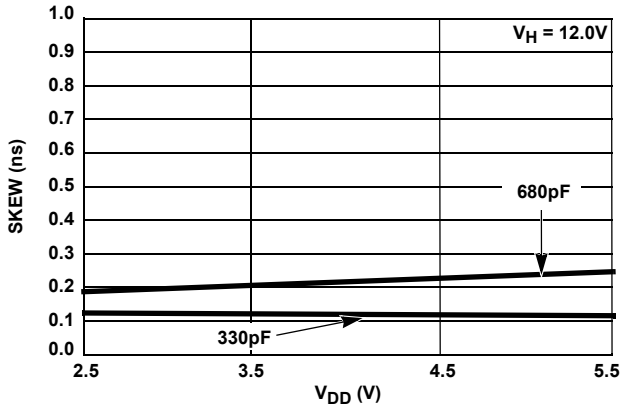

FIGURE 30. tSkewR vs V_{DD}

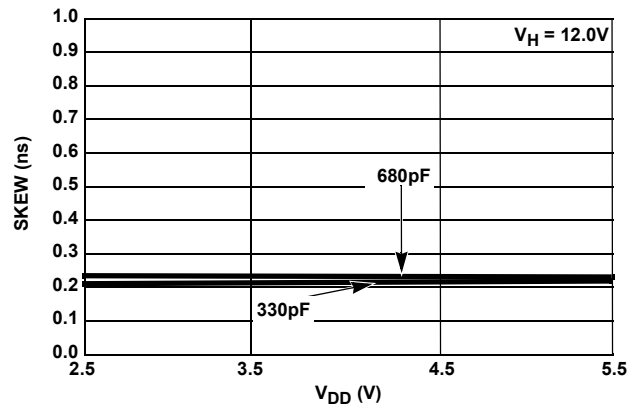

FIGURE 31. tSkewF vs V_{DD}

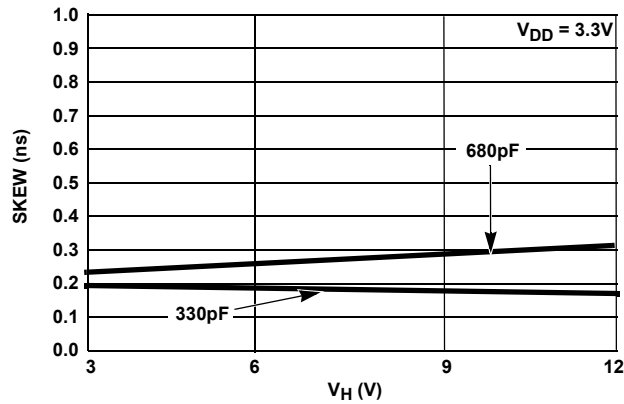

FIGURE 32. tSkewR vs V_H

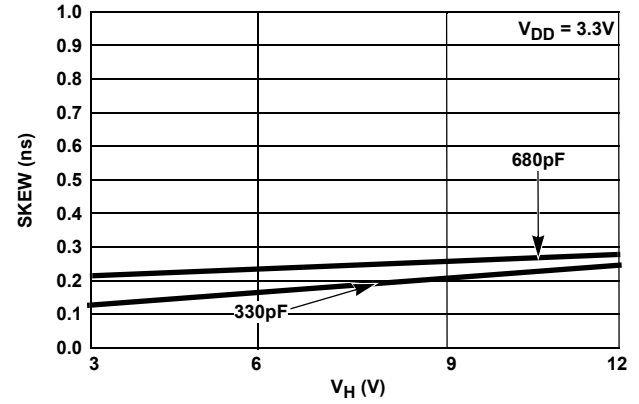

FIGURE 33. tSkewF vs V_H

Typical Performance Curves Discussion

r_{ON}

The r_{ON} source is tested by placing the device in constant drive high condition and connecting a -50mA constant current source to the driver output. The voltage drop is measured from V_H to driver output for r_{ON} calculations.

The r_{ON} sink is tested by placing the device in constant driver low condition and connecting a +50mA constant current source. The voltage drop from driver out to ground is measured for r_{ON} calculations.

Dynamic Tests

All dynamic tests are conducted with ISL55110 and ISL55111 evaluation board(s) (ISL55110_11EVAL2Z). Driver loads are soldered to the evaluation board. Measurements are collected with P6245 active FET Probes and TDS5104 oscilloscope. Pulse stimulus is provided by HP8131 pulse generator.

The ISL55110 and ISL55111 evaluation boards provide test point fields for leadless connection to either an active FET

probe or differential probe. “TP - IN_A/_B” test points are used for monitoring pulse input stimulus. “TP - OA/OB” allows monitoring of driver output waveforms. C₆ and C₇ are the usual placement for driver loads. R₃ and R₄ are not populated and are provided for user-specified, more complex load characterization.

Pin Skew

Pin skew measurements are based on the difference in propagation delay of the two channels. Measurements are made on each channel from the 50% point on the stimulus point to the 50% point on the driver output. The difference in the propagation delay for Channel A and Channel B is considered to be skew.

Both rising propagation delay and falling propagation delay are measured and report as tSkewR and tSkewF.

50MHz Tests

50MHz Tests reported as no load actually include evaluation board parasitics and a single TEK 6545 FET probe. However, no driver load components are installed and C₆ through C₉ and R₃ through R₆ are not populated.

General

The most dynamic measurements are presented in three ways:

1. Over-temperature with a V_{DD} of 3.6V and V_H of 12V.
2. At ambient with V_H set to 12V and V_{DD} data points of 2.5V, 3.5V, 4.5V and 5.50V.

3. The ambient tests are repeated with V_{DD} of 3.3V and V_H data points of 3V, 6V, 9V and 12V.



FIGURE 34. ISL55110_11EVAL2Z (QFN) EVALUATION BOARD

Detailed Description

The ISL55110 and ISL55111 are dual high-speed MOSFET drivers intended for applications requiring accurate pulse generation and buffering. Target applications include ultrasound, CCD imaging, automotive piezoelectric distance sensing and clock generation circuits.

With a wide output voltage range and low ON-resistance, these devices can drive a variety of resistive and capacitive loads with fast rise and fall times, allowing high-speed operation with low skew as required in large CCD array imaging applications.

The ISL55110 and ISL55111 are compatible with 3.3V and 5V logic families and incorporate tightly controlled input thresholds to minimize the effect of input rise time on output pulse width. The ISL55110 has a pair of in-phase drivers while the ISL55111 has two drivers operating in anti-phase. Both channels of the device have independent inputs to allow external time phasing if required.

In addition to driving power MOSFETs, the ISL55110 and ISL55111 are well suited for other applications such as bus, control signal and clock drivers for large memory arrays on microprocessor boards, where the load capacitance is large and low propagation delays are required. Other potential applications include peripheral power drivers and charge pump voltage inverters.

Input Stage

The input stage is a high impedance buffer with rise/fall hysteresis. This means that the inputs will be directly compatible with both TTL and lower voltage logic over the entire V_{DD} range. The user should treat the inputs as high-speed pins and keep rise and fall times to <2ns.

Output Stage

The ISL55110 and ISL55111 outputs are high-power CMOS drivers swinging between ground and V_H . At $V_H = 12V$, the output impedance of the inverter is typically 3.0Ω . The high peak current capability of the ISL55110 and ISL55111 enables it to drive a 330pF load to 12V with a rise time of <3.0ns over the full temperature range. The output swing of the ISL55110 and ISL55111 comes within <30mV of the V_H and Ground rails.

Application Notes

Although the ISL55110 and ISL55111 are simply dual level shifting drivers, there are several areas to which careful attention must be paid.

Grounding

Since the input and the high current output current paths both include the ground pin, it is very important to minimize any common impedance in the ground return. Since the ISL55111 has one inverting input, any common impedance will generate negative feedback and may degrade the delay times and rise and fall times. Use a ground plane if possible or use separate ground returns for the input and output circuits. To minimize any common inductance in the ground return, separate the input and output circuit ground returns as close to the ISL55110 and ISL55111 as possible.

Bypassing

The rapid charging and discharging of the load capacitance requires very high current spikes from the power supplies. A parallel combination of capacitors, which have a low impedance over a wide frequency range should be used. A 4.7 μ F tantalum capacitor in parallel with a low inductance 0.1 μ F capacitor is usually sufficient bypassing.

Output Damping

Ringling is a common problem in any circuit with very fast rise or fall times. Such ringling will be aggravated by long inductive lines with capacitive loads. Techniques to reduce ringling include:

1. Reduce inductance by making printed circuit board traces as short as possible.
2. Reduce inductance by using a ground plane or by closely coupling the output lines to their return paths.
3. Use small damping resistor in series with the output of the ISL55110 and ISL55111. Although this reduces ringling, it will also slightly increase the rise and fall times.
4. Use good bypassing techniques to prevent supply voltage ringling.

Power Dissipation Calculation

The Power dissipation equation has three components:

1. Quiescent power dissipation.
2. Power dissipation due to internal parasitics.
3. Power dissipation because of the load capacitor.

Power dissipation due to internal parasitics is usually the most difficult to accurately quantize. This is primarily due to crowbar current which is a product of both the high and low drivers conducting effectively at the same time during driver transitions. Design goals always target the minimum time for this condition to exist. Given that how often this occurs is a product of frequency, crowbar effects can be characterized as internal capacitance.

Lab tests are conducted with driver outputs disconnected from any load. With design verification packaging, bond wires are removed to aid in the characterization process. Based on laboratory tests and simulation correlation of those results, [Equation 1](#) defines the ISL55110 and ISL55111 power dissipation per channel:

$$P = V_{DD} \times 3.3e-3 + 10pF \times V_{DD}^2 \times f + 135pF \times V_H^2 \times f + C_L \times V_H^2 \times f \quad (\text{Watts/Channel}) \quad (\text{EQ. 1})$$

- Where 3.3mA is the quiescent current from the V_{DD} . This forms a small portion of the total calculation. When figuring two channel power consumption, only include this current once.
- 10pF is the approximate parasitic capacitor (inverters, etc.), which the V_{DD} drives.
- 135pF is the approximate parasitic at the D_{OUT} and its buffers. This includes the effect of the crowbar current.
- C_L is the load capacitor being driven.

Power Dissipation Discussion

Specifying continuous pulse rates, driver loads and driver level amplitudes are key in determining power supply requirements, as well as dissipation/cooling necessities. Driver output patterns also impact these needs. The faster the pin activity, the greater the need to supply current and remove heat.

As detailed in the [“Power Dissipation Calculation” on page 13](#), power dissipation of the device is calculated by taking the DC current of the V_{DD} (logic) and V_H current (driver rail) times the respective voltages and adding the product of both calculations. The average DC current measurements of I_{DD} and I_H should be done while running the device with the planned V_{DD} and V_H levels and driving the required pulse activity of both channels at the desired operating frequency and driver loads.

Therefore, the user must address power dissipation relative to the planned operating conditions. Even with a device mounted per [Notes 4](#) or [5](#) under “Thermal Information”, given the high speed pulse rate and amplitude capability of the ISL55110 and ISL55111, it is possible to exceed the +150°C “absolute maximum junction temperature”. Therefore, it is important to calculate the maximum junction temperature for the application to determine if operating conditions need to be modified for the device to remain in the safe operating area.

The maximum power dissipation allowed in a package is determined according to [Equation 2](#):

$$P_{D_{MAX}} = \frac{T_{J_{MAX}} - T_{A_{MAX}}}{\theta_{JA}} \quad (\text{EQ. 2})$$

Where:

- $T_{J_{MAX}}$ = Maximum junction temperature
- $T_{A_{MAX}}$ = Maximum ambient temperature
- θ_{JA} = Thermal resistance of the package
- $P_{D_{MAX}}$ = Maximum power dissipation in the package

The maximum power dissipation actually produced by an IC is the total quiescent supply current times the total power supply voltage, plus the power in the IC due to the loads. Power also depends on number of channels changing state and frequency of operation. The extent of continuous active pulse generation will greatly effect dissipation requirements.

The user should evaluate various heatsink/cooling options in order to control the ambient temperature part of the equation. This is especially true if the user’s applications require continuous, high-speed operation. A review of the θ_{JA} ratings of the TSSOP and QFN packages clearly show the QFN package to have better thermal characteristics.

The reader is cautioned against assuming a calculated level of thermal performance in actual applications. A careful inspection of conditions in your application should be conducted. Great care must be taken to ensure die temperature does not exceed +150°C Absolute Maximum Thermal Limits.

Important Note: The ISL55110 and ISL55111 QFN package metal plane is used for heat sinking of the device. It is electrically connected to ground (i.e., pin 11).

Power Supply Sequencing

Apply V_{DD} , then V_H .

Power-Up Considerations

Digital inputs should never be undriven. Do not apply slow analog ramps to the inputs. Again, place decoupling caps as close to the package as possible for both V_{DD} and especially V_H .

Special Loading

With most applications, the user will usually have a special load requirement. [Contact](#) Renesas for evaluation boards.

Revision History

The revision history provided is for informational purposes only and is believed to be accurate, but not warranted. Please go to web to make sure you have the latest revision.

DATE	REVISION	CHANGE
Apr 29, 2021	9.0	Updated links throughout. Updated Ordering information table to include the tape and reel versions and updated notes. Removed About Intersil section. Updated POD L16.4x4A to the latest version changes are as follows: Updated to new POD format by removing table listing dimensions and moving dimensions onto drawing. Added Typical Recommended Land Pattern. Removed package option. Updated bottom view: 2.40 to 2.45 +0.10/-0.152.45 (2 dimensions) Updated typical recommend land pattern: 2.40 to 2.45
Jan 29, 2015	8.0	Page 1 , "Description" section, 4th sentence, removed the word "automotive" before the word piezoelectric". "Applications", removed 3rd bullet item: "Automotive piezo driver applications"
May 30, 2014	7.0	Throughout document, changed "HIZ" to "ENABLE" and "PDN" pin references to "PD". Page 2 , "Pin Descriptions" table; Changed "Function" entries for GND and ENABLE pins. Added EP row. Page 3 , "Ordering Info" table; Added "TSSOP" or "QFN" to the Evaluation board entries to clarify. Page 4 and page 5 ; Changed "Driver Output Swing Range" Test Conditions entry from "VH voltage to Ground" to "OA or OB = "1", Voltage referenced to GND and changed "Driver Supply Quiescent Current" "Test Conditions" entry from "No resistive load D _{OUT} " to "Outputs Unloaded". Added "Figure 1" reference to the driver rise and fall time "Test Conditions". Page 5 ; Changed "t _{EN} " and "t _{DIS} " descriptions. Figure 2 on page 6 : changed "Thresholds" to "Times" in title. Figure 3 on page 6 : in "tSKEWR" equation, changed "CHN 1" and "CHN 2" to "CHN A" and "CHN B" and added "absolute value" indicator. Figures 4 and 5 : changed "Resistance" to "Voltage" in titles. Figures 6 and 7 : changed "Resistance" to "Voltage" in titles. Figures 9 and 11 : added "Operating" to titles. Figure 12 : Fixed Y-axis scale. Figures 14 and 15 : Added "vs. VDD" to titles. Figures 32 and 33 : changed X-axis Label from "V _{DD} " to "VH". Figure 34 : Added "QFN" to title. "Power Dissipation Discussion" on page 14 , changed "It is electrically connected to the negative supply potential ground" to "It is electrically connected to ground (i.e., pin11)" and, in the "Special Loading" section, removed text "or to request a device characterization to your requirements in our lab".
August 8, 2013	6.0	Page 4 In Electrical Spec Table changed units from mA to µA I _{LH} Input Current Logic High ENABLE = VDD (QFN only)-
July 9, 2012	5.0	Page 4 - Removed "Recommended Operating Conditions table", which was located above dc electrical spec. table and placed in the abs max ratings table to meet Intersil standards. Page 5 - DC Electrical Spec: Modified IH-PDN parameter (Driver Supply Power-Down Current) Max limit value from 1µ to 2.5µ. Added Revision History table on page 15 .

Revision History

The revision history provided is for informational purposes only and is believed to be accurate, but not warranted. Please go to web to make sure you have the latest revision. (Continued)

DATE	REVISION	CHANGE
Feb 9, 2011	4.0	<p>For 8 ld TSSOP, added theta JC value of 46C/W. Added foot note that for TSSOP package theta JC the case temp location is measured in the center of the top of the package.</p> <p>Page 1: Added following sentence to 3rd paragraph: "Both inputs of the device have independent inputs to allow external time phasing if required."</p> <p>Updated Tape & Reel note in Ordering Information on page 3 from "Add "-T" suffix for tape and reel." to new standard "Add "-T*" suffix for tape and reel." The "*" covers all possible tape and reel options</p> <p>Added MSL note to Ordering Information</p> <p>Page 5: Updated over temp note in Min Max column of spec tables from "Parameters with MIN and/or MAX limits are 100% tested at +25°C, unless otherwise specified. Temperature limits established by characterization and are not production tested." to new standard "Compliance to datasheet limits is assured by one or more methods: production test, characterization and/or design."</p> <p>Page 13: Changed Equation 1 from: $P_{VDD} = 3 \times 10^{-3} + 10^{-4} \times V_{DD}^2 + 135 \times 10^{-6} \times V_{H2}$ (EQ. 1) $CL \times V_{H2} \text{ (Watts/Channel) To } P_{VDD} = 3 \times 10^{-3} + 10^{-4} \times V_{DD}^2 + 135 \times 10^{-6} \times V_{H2} \times f + CL \times V_{H2}$ (Watts/Channel) (EQ. 1)</p> <p>Page 14: Removed the following sentence from "Power Supply Sequencing": "The ISL55110, ISL55111 references both VDD and the VH driver supplies with respect to Ground. Therefore, apply VDD, then VH." Replaced with: "Apply VDD, then VH." Added subsection "Power Up Considerations" and moved text that was in the "Power Supply Sequencing" section to this section. ("Digital Inputs should...especially VH.")</p> <p>Page 18: Updated POD M8.173 as follows: Updated to new POD standards as follows: Moved dimensions from table onto drawing. Added Land Pattern. No dimension changes.</p>
Dec 16, 2008	3.0	<p>Typical timing for Power Down / Up and HIZ On / Off have been updated.</p> <p>Removed Max values for Power Down / Up and HIZ On / Off parameters.</p> <p>Updated Pb-free Note to new verbiage based on lead finish.</p> <p>Corrected part marking for ISL55111IRZ (was previously missing a "1").</p> <p>Updated verbiage for Note 4 to "Parameters with Min/Max..."</p>
Dec 12, 2007	2.0	Silicon was re-spun to improve/balance Pulse width characteristics
Mar 21, 2007	1.0	Updated POD from L16.4x4 to L16.4x4A in ordering information and page 14.
Mar 3, 2007	0.0	Initial Release

Package Outline Drawings

L16.4x4A

16 Lead Quad Flat No-Lead Plastic Package

Rev 4, 7/17

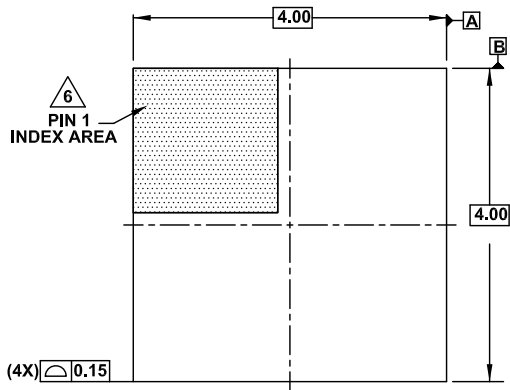

TOP VIEW

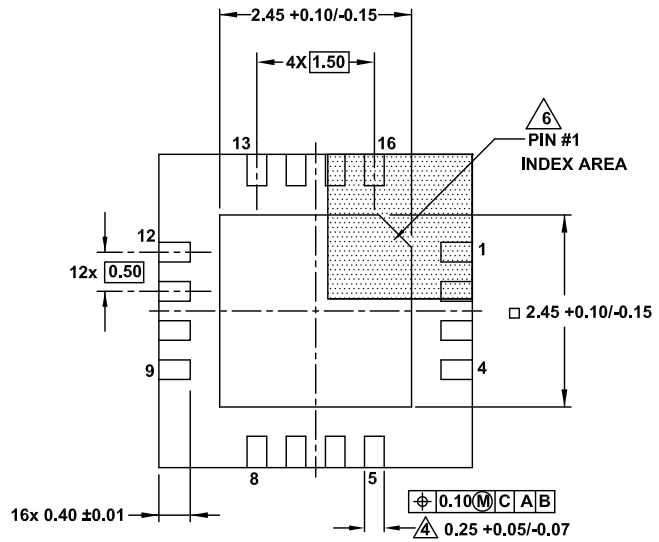

BOTTOM VIEW

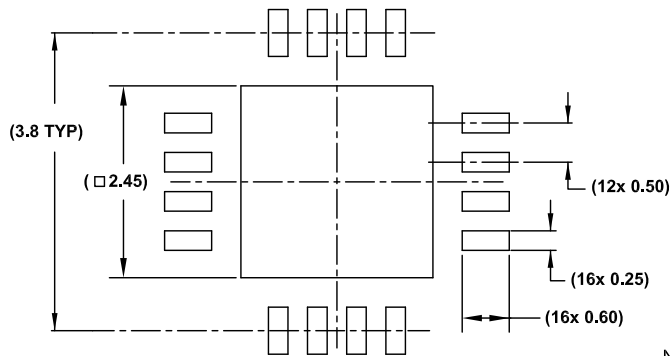

TYPICAL RECOMMENDED LAND PATTERN

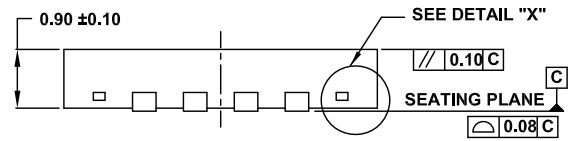

SIDE VIEW

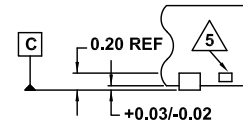

DETAIL "X"

NOTES:

1. Dimensions are in millimeters.
Dimensions in () for Reference Only.
2. Dimensioning and tolerancing conform to AMSEY14.5m-1994.
3. Unless otherwise specified, tolerance : Decimal ±0.05
4. Dimension applies to the metallized terminal and is measured between 0.15mm and 0.30mm from the terminal tip.
5. Tiebar shown (if present) is a non-functional feature.
6. The configuration of the pin #1 identifier is optional, but must be located within the zone indicated. The pin #1 identifier may be either a mold or mark feature.

M8.173
 8 Lead Thin Shrink Small Outline Package (TSSOP)
 Rev 2, 01/10

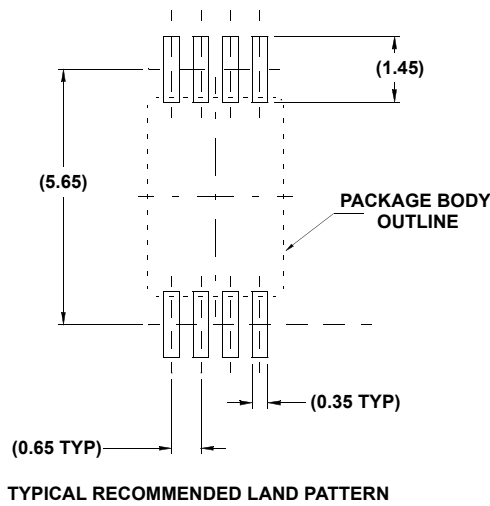
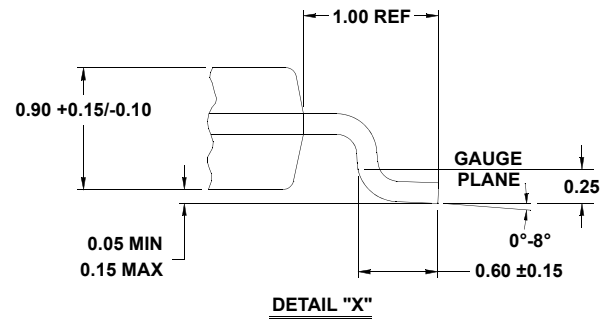
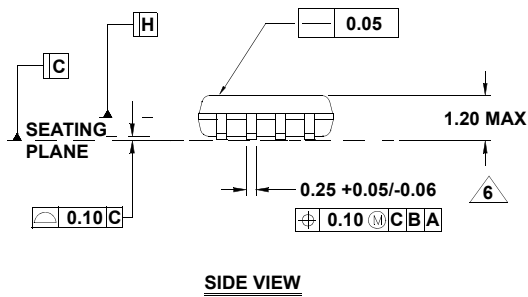
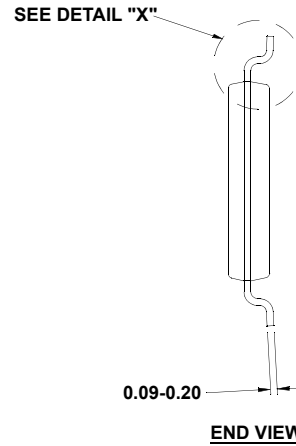
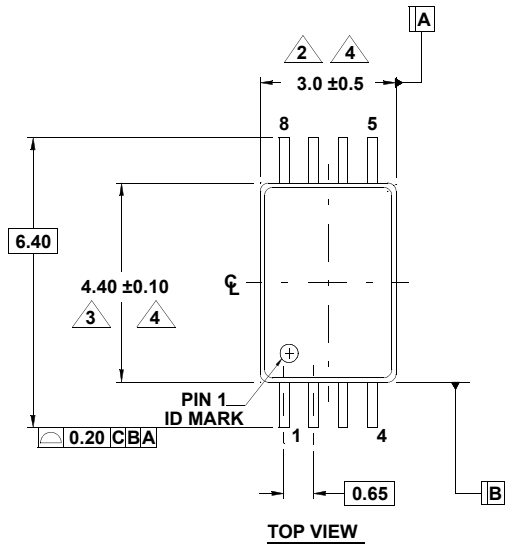

NOTES:

1. Dimensions are in millimeters.
 Dimensions in () for Reference Only.
2. Dimension does not include mold flash, protrusions or gate burrs. Mold flash, protrusions or gate burrs shall not exceed 0.15 per side.
3. Dimension does not include interlead flash or protrusion. Interlead flash or protrusion shall not exceed 0.15 per side.
4. Dimensions are measured at datum plane H.
5. Dimensioning and tolerancing per ASME Y14.5M-1994.
6. Dimension on lead width does not include dambar protrusion. Allowable protrusion shall be 0.08 mm total in excess of dimension at maximum material condition. Minimum space between protrusion and adjacent lead is 0.07mm.
7. Conforms to JEDEC MO-153, variation AC. Issue E