

# ISL59833

## 200MHz Single Supply Video Driver With Charge Pump

FN6334  
Rev 1.00  
March 5, 2007

The ISL59833 is a revolutionary device that allows true single-supply operation of video amplifiers. Designed for systems requiring output swing below ground but lacking a negative power supply, the ISL59833 generates the required negative rail internally from a +3.3V power supply. This allows for DC-accurate coupling of video onto a 75Ω double-terminated line. The buffers have an integrated 6dB, eliminating the need for external gain-setting resistors. An external reference voltage can be applied to the REF pin to shift the analog video level down by the desired amount.

### Ordering Information

PART NUMBER (Note)	PART MARKING	TAPE & REEL	PACKAGE (Pb-free)	PKG. DWG. #
ISL59833IAZ	59833 IAZ	-	16 Ld QSOP	MDP0040
ISL59833IAZ-T7	59833 IAZ	7"	16 Ld QSOP	MDP0040

NOTE: Intersil Pb-free plus anneal products employ special Pb-free material sets; molding compounds/die attach materials and 100% matte tin plate termination finish, which are RoHS compliant and compatible with both SnPb and Pb-free soldering operations. Intersil Pb-free products are MSL classified at Pb-free peak reflow temperatures that meet or exceed the Pb-free requirements of IPC/JEDEC J STD-020.

### Features

- Triple single-supply buffer
- Generates negative rail from from single +3.3V supply
- No output DC blocking capacitor needed
- 200MHz -3dB bandwidth
- 50MHz 0.1dB bandwidth
- Fixed gain of 2 output buffer
- Amplifier enable/disable function control
- Outputs are high impedance in power-down mode
- Pb-free plus anneal available (RoHS compliant)

### Applications

- Driving video

### Pinout

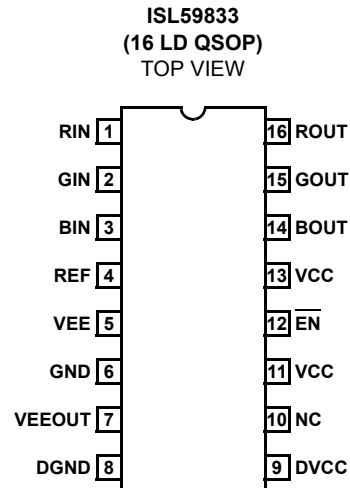

**Absolute Maximum Ratings**

$V_{CC}$ , Supply Voltage between $V_S$ and GND	.5V
$V_{IN}$ , $V_{REF}$	$V_{CC} + 0.3V$ , $V_{EE} - 0.3V$
Voltage between $V_{IN}$ and $V_{REF}$	$\pm 2V$
Maximum Continuous Output Current	30mA
ESD Classification	
Human Body Model	2000V
Machine Model	200V

**Thermal Information**

Operating Temperature	-40°C to +85°C
Maximum Die Temperature	+150°C
Storage Temperature	-65°C to +150°C
Lead Temperature	+260°C
Power Dissipation	See Curves
Pb-free reflow profile	see link below <a href="http://www.intersil.com/pbfree/Pb-FreeReflow.asp">http://www.intersil.com/pbfree/Pb-FreeReflow.asp</a>

**CAUTION:** Stresses above those listed in "Absolute Maximum Ratings" may cause permanent damage to the device. This is a stress only rating and operation of the device at these or any other conditions above those indicated in the operational sections of this specification is not implied.

**IMPORTANT NOTE:** All parameters having Min/Max specifications are guaranteed. Typical values are for information purposes only. Unless otherwise noted, all tests are at the specified temperature and are pulsed tests, therefore:  $T_J = T_C = T_A$

**AC Electrical Specifications**  $V_{CC} = DV_{CC} = +3.3V$ , REF = GND,  $T_A = +25^\circ C$ ,  $R_L = 150\Omega$ , unless otherwise specified.

PARAMETER	DESCRIPTION	CONDITIONS	MIN	TYP	MAX	UNIT
BW - 3dB	3dB Bandwidth	$V_{OUT} = 200mV_{PP}$		200		MHz
		$V_{OUT} = 2V_{PP}$		100		MHz
BW 0.1dB	0.1dB Bandwidth	$V_{OUT} = 2V_{PP}$		50		MHz
$S_R$	Slew Rate	$V_{IN} = 2V_{PP}$	500			V/ $\mu s$
$d_G$	Differential Gain			0.07		%
$d_P$	Differential Phase			0.06		°
$X_T$	Hostile Crosstalk	6MHz		-90		dB
I	Input to Output Isolation	6MHz		-70		dB
$V_N$	Input Noise Voltage			20		nV/ $\sqrt{Hz}$
$f_{CP}$	Charge Pump Switching Frequency			168		MHz
Load Reg	$V_{EE}$ Load Regulation	$I_{EE} = 0mA$ to 10mA		9	30	mV
$V_{RIPPLE}$	Output Amp Ripple Voltage			30		mV
		With Bead Core to $DV_{CC}$		10		mV

**DC Electrical Specifications**  $V_{CC} = DV_{CC} = +3.3V$ , REF = GND,  $T_A = +25^\circ C$ ,  $R_L = 150\Omega$ , unless otherwise specified.

PARAMETER	DESCRIPTION	CONDITIONS	MIN	TYP	MAX	UNIT
V+	Supply Range		3.0		3.6	V
$V_G\%$	Gain Error	$R_L = 150\Omega$ , $V_{OUT} = -1V$ to +2.5V			1.5	%
$\Delta G$	Gain Matching	$R_L = 150\Omega$		0.5		%
$I_{IN}$	Analog Input Leakage Current	$V_{IN} = 0V$ to 1.5V		$\pm 0.1$	$\pm 1$	$\mu A$
$V_{OS}$	Output Offset Voltage	$V_{REF} = 0$	-25	7	+25	mV
$V_{OUT+}$	Maximum Output Voltage	$R_L = 75\Omega$	2.4	2.5		V
		$R_L = 150\Omega$	2.7	2.9		V
$V_{OUT-}$	Minimum Output Voltage	$R_L = 75\Omega$		-1.3	-1	V
		$R_L = 150\Omega$		-1.5	-1.2	V
$I_{OUT+}$	Output Current	$R_L = 10\Omega$ , $V_{IN} = 1.2V$	50	80		mA
$I_{OUT-}$	Output Current	$R_L = 10\Omega$ , $V_{IN} = -0.3V$		-40	-18	mA
$Z_{OUT}$	Disabled Output Impedance	$\overline{EN} = 3.3V$ (Amp Disabled)		500		k $\Omega$
$I_{REF}$	Reference Input Leakage Current		1	2.3	3.5	$\mu A$
PSRR	Power Supply Rejection Ratio		50	62		dB

**DC Electrical Specifications**  $V_{CC} = DV_{CC} = +3.3V$ ,  $REF = GND$ ,  $T_A = +25^{\circ}C$ ,  $R_L = 150\Omega$ , unless otherwise specified. (Continued)

PARAMETER	DESCRIPTION	CONDITIONS	MIN	TYP	MAX	UNIT
$I_S$	Supply Current	$\overline{EN} = GND$ (Amp Enabled)		97	130	mA
		$\overline{EN} = 3.3V$ (Amp Disabled)		60	90	mA

**Pin Descriptions**

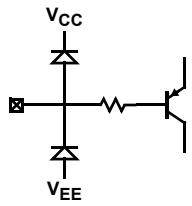
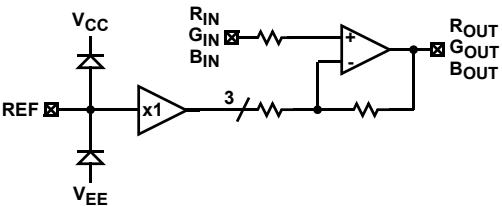
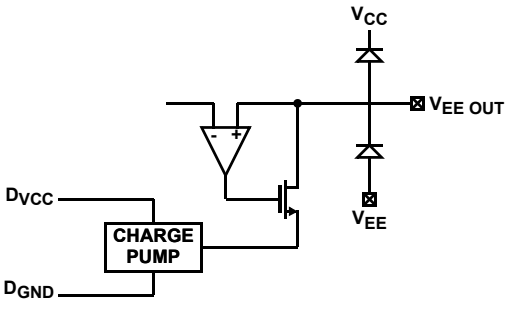
PIN NUMBER	PIN NAME	PIN FUNCTION	EQUIVALENT CIRCUIT
1	RIN	Analog input	 <p>CIRCUIT 1</p>
2	GIN	Analog input	Reference Circuit 1
3	BIN	Analog input	Reference Circuit 1
4	REF	Reference input High impedance input controlling offset of amplifiers	 <p>CIRCUIT 2</p>
5	VEE	Chip substrate (negative power supply for amplifiers)	 <p>CIRCUIT 3</p>
6	GND	Analog ground	
7	VEE OUT	Charge pump output	Reference Circuit 3
8	DGND	Charge pump ground	Reference Circuit 3
9	DVCC	Charge pump supply voltage	Reference Circuit 3
10	NC	Not connected	
11, 13	VCC	Positive power supply	

**Pin Descriptions** (Continued)

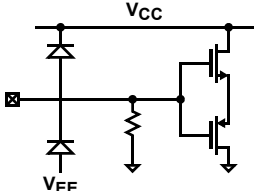
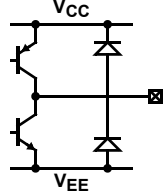
PIN NUMBER	PIN NAME	PIN FUNCTION	EQUIVALENT CIRCUIT
12	$\overline{\text{EN}}$	Power-down Input Low: Normal Operation High: Power-down Charge Pump and Amplifiers	 <p>CIRCUIT 4</p>
14	BOUT	Analog output	 <p>CIRCUIT 5</p>
15	GOUT	Analog output	Reference Circuit 5
16	ROUT	Analog output	Reference Circuit 5

**Typical Performance Curves**

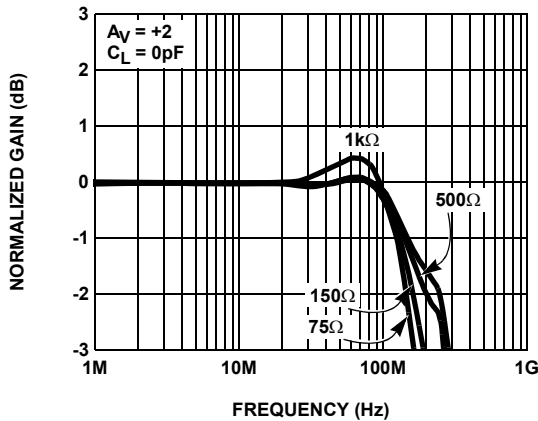

FIGURE 1. GAIN vs FREQUENCY FOR VARIOUS  $R_{LOAD}$

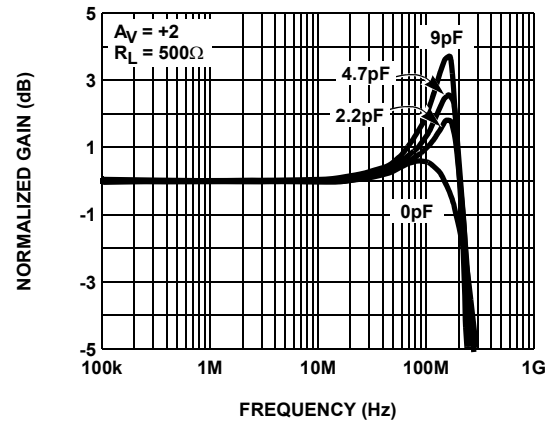

FIGURE 2. GAIN vs FREQUENCY FOR VARIOUS  $C_{LOAD}$

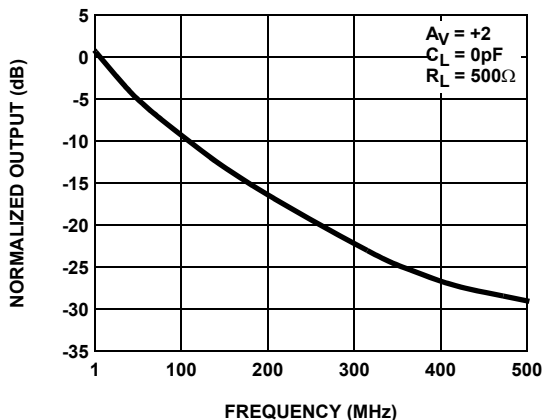

FIGURE 3.  $V_{REF}$  PIN OUTPUT FREQUENCY RESPONSE

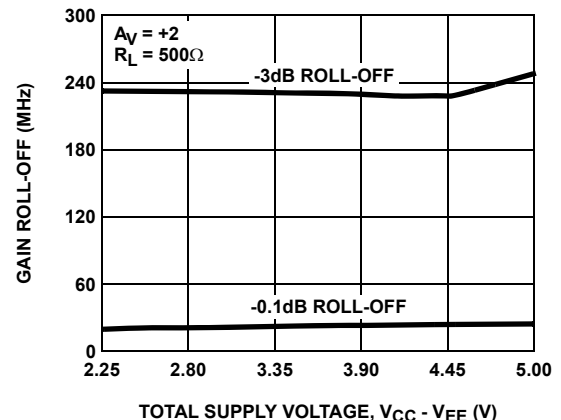

FIGURE 4. GAIN ROLL-OFF

Typical Performance Curves (Continued)

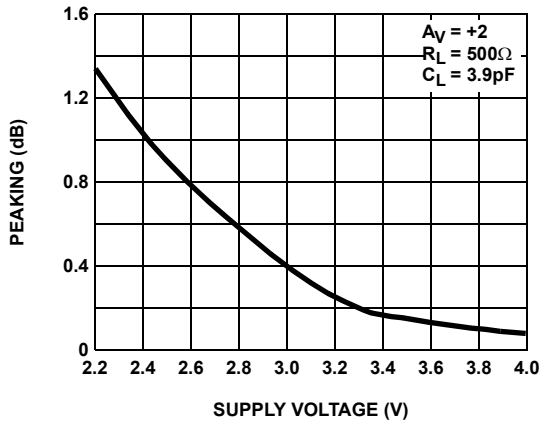

FIGURE 5. PEAKING vs SUPPLY VOLTAGE

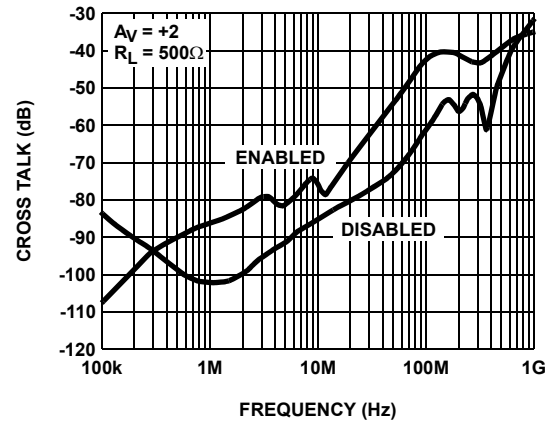

FIGURE 6. CROSS TALK CHANNEL TO CHANNEL (TYPICAL)

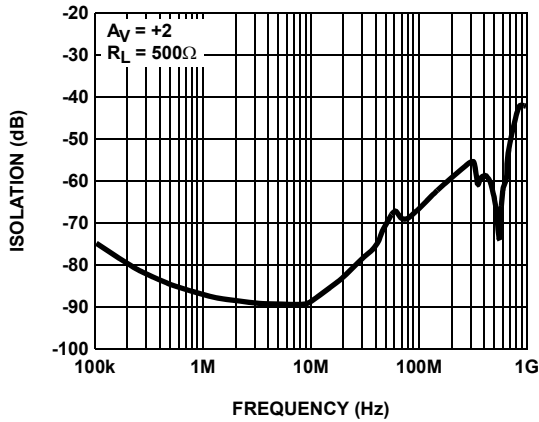

FIGURE 7. INPUT TO OUTPUT ISOLATION vs FREQUENCY

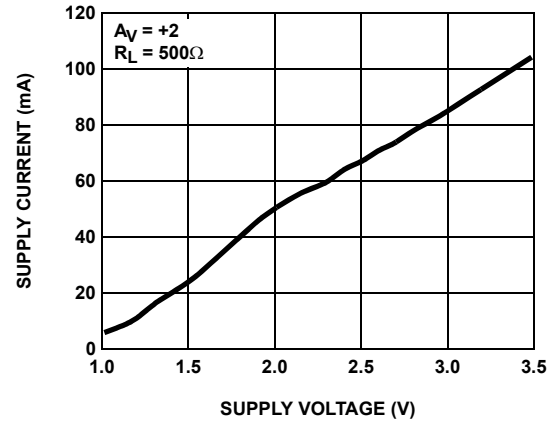

FIGURE 8. SUPPLY CURRENT vs SUPPLY VOLTAGE

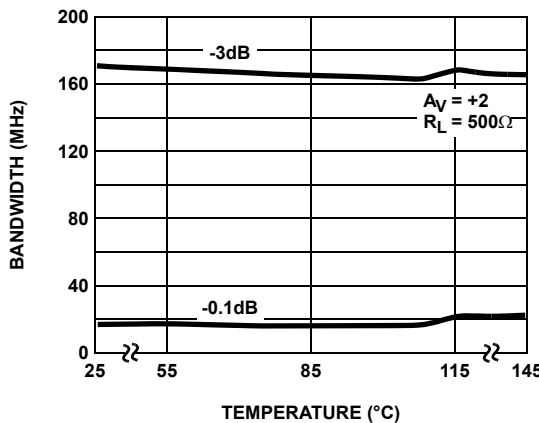

FIGURE 9. BANDWIDTH vs TEMPERATURE

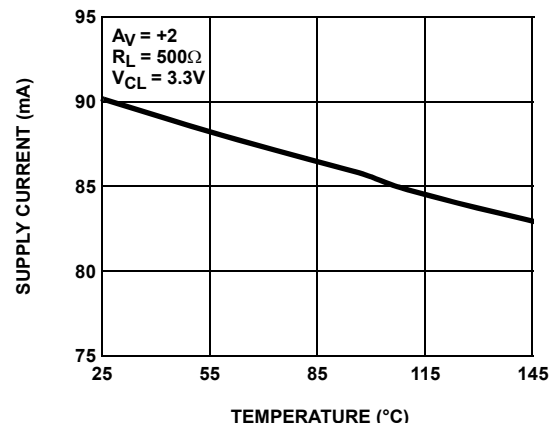

FIGURE 10. SUPPLY CURRENT vs TEMPERATURE

Typical Performance Curves (Continued)

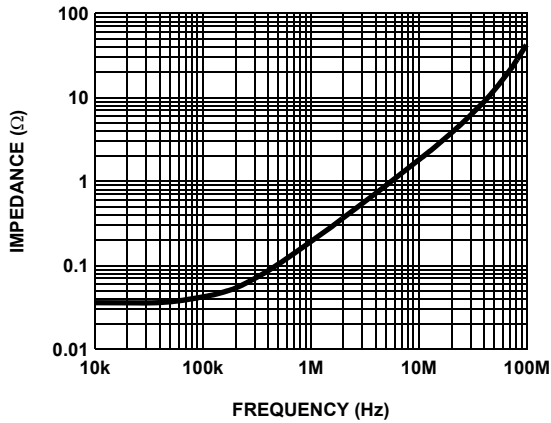

FIGURE 11. OUTPUT IMPEDANCE vs FREQUENCY

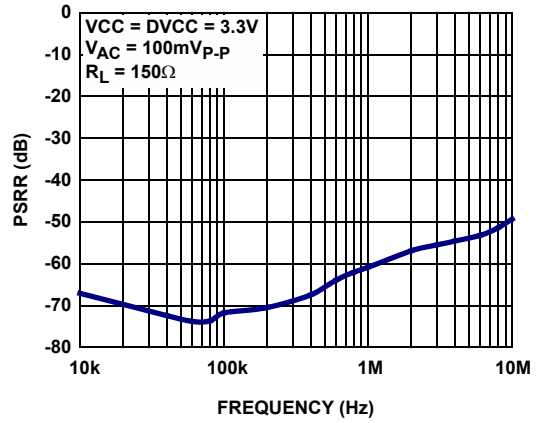

FIGURE 12. POWER SUPPLY REJECTION RATIO vs FREQUENCY

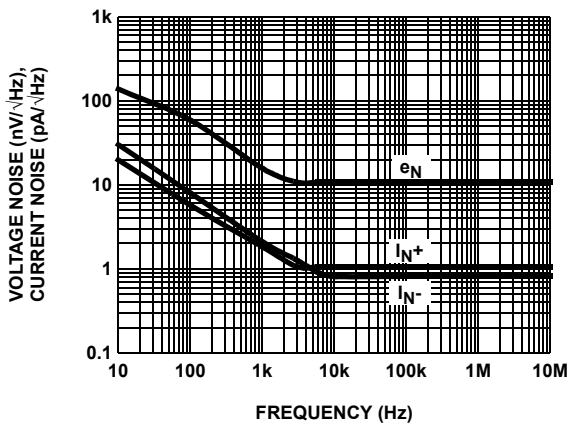

FIGURE 13. VOLTAGE AND CURRENT NOISE vs FREQUENCY

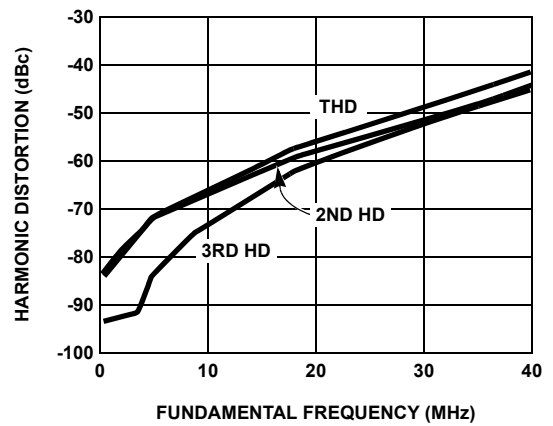

FIGURE 14. HARMONIC DISTORTION vs FREQUENCY

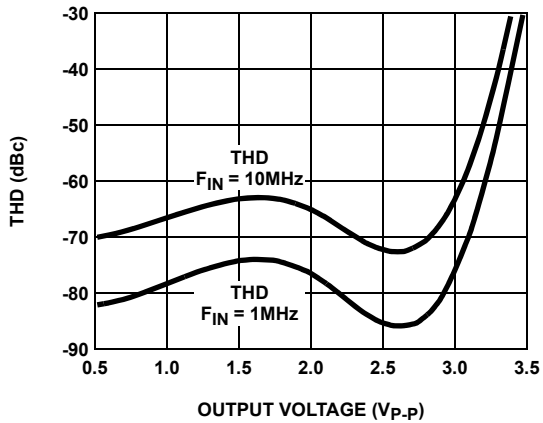

FIGURE 15. THD vs OUTPUT VOLTAGE

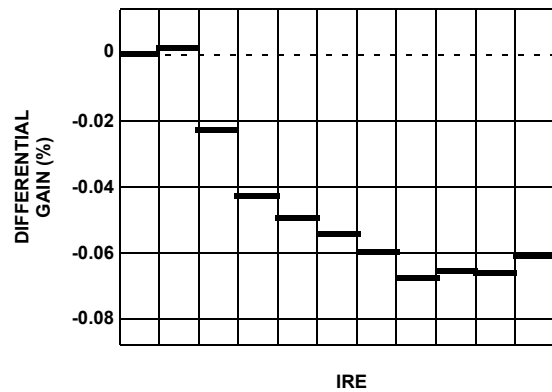

FIGURE 16. DIFFERENTIAL GAIN

Typical Performance Curves (Continued)

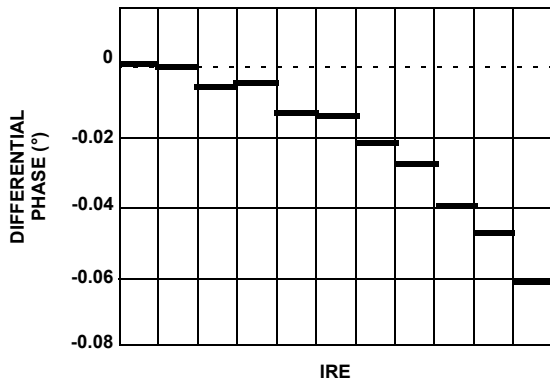

FIGURE 17. DIFFERENTIAL PHASE

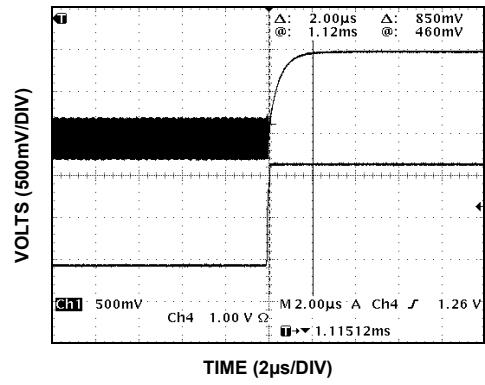

FIGURE 18. DISABLE TIME

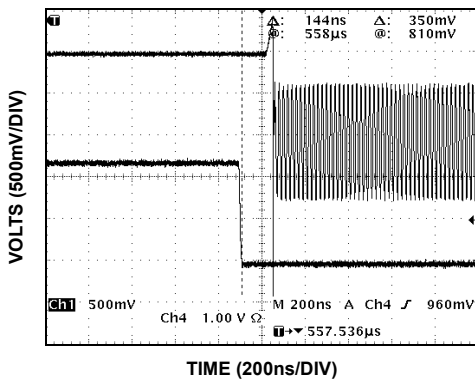

FIGURE 19. ENABLE TIME

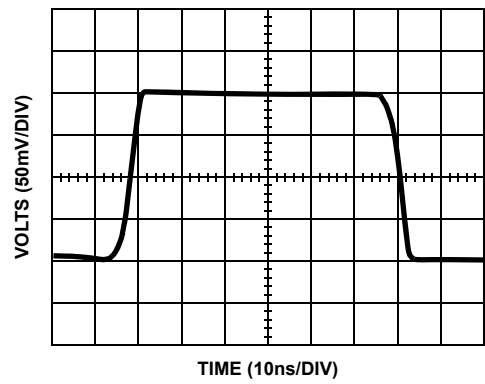

FIGURE 20. SMALL SIGNAL RISE AND FALL TIMES

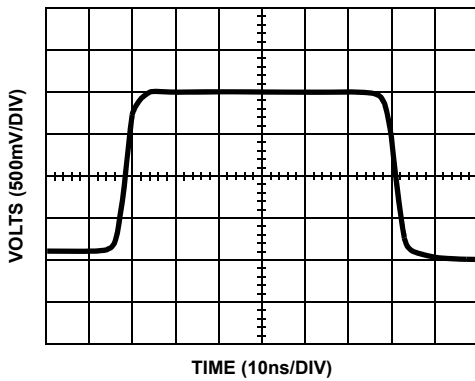

FIGURE 21. LARGE SIGNAL RISE AND FALL TIMES

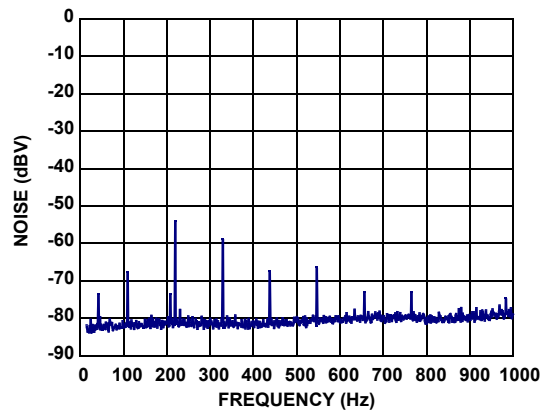
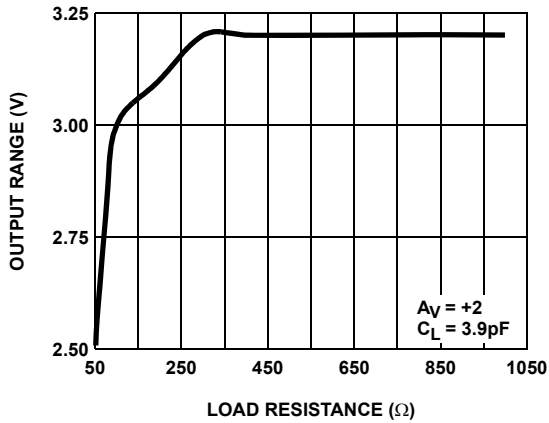
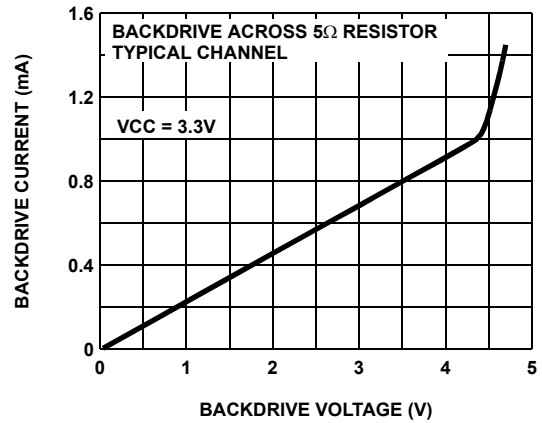

FIGURE 22. NOISE FLOOR WITH CHARGE PUMP HARMONICS

**Typical Performance Curves** (Continued)



**FIGURE 23. MAXIMUM OUTPUT MAGNITUDE vs LOAD RESISTANCE**



**FIGURE 24. BACKDRIVE VOLTAGE vs CURRENT AMP DISABLED OUTPUT LOADING**

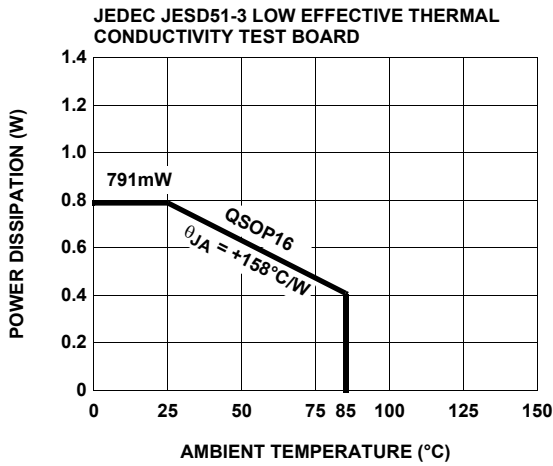

**FIGURE 25. PACKAGE POWER DISSIPATION vs AMBIENT TEMPERATURE**

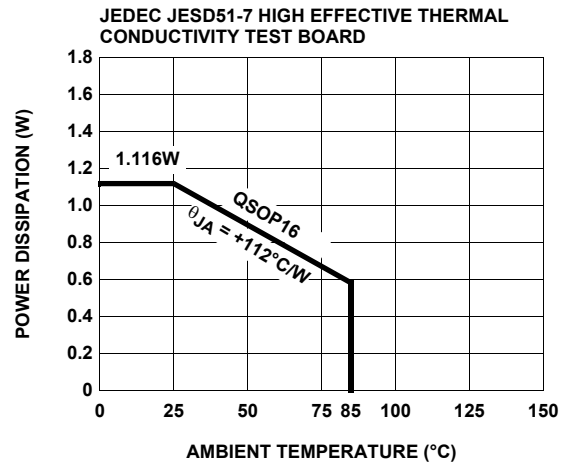

**FIGURE 26. PACKAGE POWER DISSIPATION vs AMBIENT TEMPERATURE**



**Block Diagram**

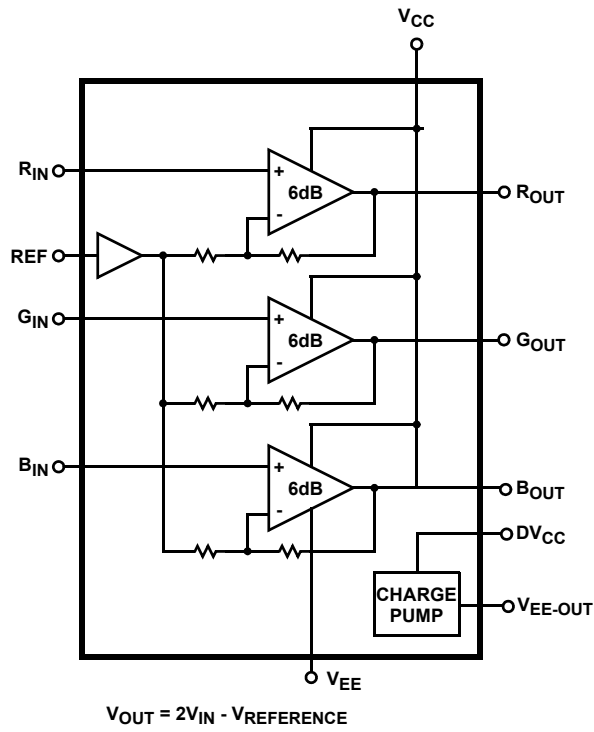



## Demo Board Schematic

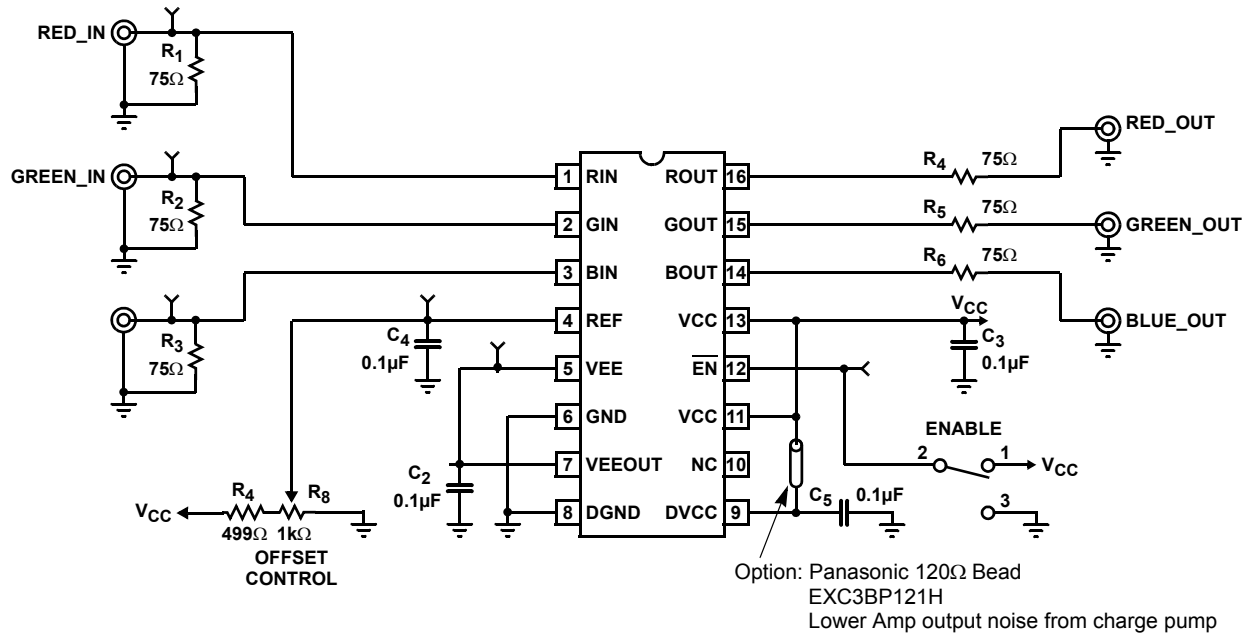

## Description of Operation and Application Information

### Theory Of Operation

The ISL59833 is a highly practical and robust marriage of three high bandwidth, high speed, low power, rail-to-rail voltage feedback amplifiers with a charge pump to provide a negative rail without an additional power supply. Designed to operate with a single supply voltage range from 0V to 3.3V, the ISL59833 eliminates the need for a split supply with the incorporation of a charge pump capable of generating a bottom rail as much as 1.6V below ground for a 4.9V range on a single 3.3V supply. This performance is ideal for NTSC video with its negative-going sync pulses.

### THE AMPLIFIER

The ISL59833 fabricated on a di-electrically isolated high speed 5V Bi-CMOS process with 4GHz PNPs and NPN transistor exceeding 20GHz - perfect for low distortion, low power demand and high frequency circuits. While the ISL59833 utilizes somewhat standard voltage mode feedback topologies, there are many non-standard analog features providing its outstanding bandwidth, rail-to-rail operation, and output drive capabilities. The input signal initially passes through a folded cascode, a topology providing enhanced frequency response by essentially fixing the base collector voltage at the junction of the input and gain stage. The collector of each input device looks directly into an emitter that is tied closely to ground through a resistor and biased with a very stable DC source. Since the voltage of this collector is "locked stable" the effective bandwidth limiting of the Miller capacitance is greatly reduced. The signal is then passed through a second fully-realized differential gain stage and

finally through a proprietary common emitter output stage for improved rail-to-rail output performance. The result is a highly-stable, low distortion, low power, and high frequency amplifier capable of driving moderately capacitive loads with near rail-to-rail performance.

### INPUT OUTPUT RANGE

The three amplifier channels have an input common mode voltage range from 0.15V below the bottom rail to within 100mV of the positive supply,  $V_{S+}$  pin (Note: bottom rail is established by the charge pump at negative one half the positive supply). As the input signal moves outside the specified range, the output signal will exhibit increasingly higher levels of harmonic distortion. And of course, as load resistance becomes lower, the current drive capability of the device will be challenged and its ability to drive close to each rail is reduced. For instance, with a load resistance of 1kΩ the output swing is within a 100mV of the rails, while a load resistance of 150Ω limits the output swing to within around 300mV of the rails.

### AMPLIFIER OUTPUT IMPEDANCE

To achieve near rail-to-rail performance, the output stage of the ISL59833 uses transistors in the common emitter configuration, typically producing higher output impedance than the standard emitter follower output stage. The exceptionally high open loop gain of the ISL59833 and local feedback reduces output impedance to less than a 2Ω at low frequency. However, since output impedance of the device is exponentially modulated by the magnitude of the open loop gain, output impedance increases with frequency as the open loop gain decreases with frequency. This inductive-like effect of the output impedance is countered in the ISL59833 with

proprietary output stage topology, keeping the output impedance low over a wide frequency range and making it possible to easily and effectively drive relatively heavy capacitive loads (see Figure 11).

### THE CHARGE PUMP

The ISL59833 charge pump provides a bottom rail up to 1.65V below ground while operating on a 0V to 3.3V power supply. The charge pump is internally regulated to one-half the potential of the positive supply. This internal multi-phase charge pump is driven by a 110MHz differential ring oscillator driving a series of inverters and charge storage circuitry. Each series inverter charges and places parallel adjoining charge circuitry slightly out of phase with the immediately preceding block. This generates a negative rail of about -1.6V with a low amplitude ripple voltage from the charge pump action. Some of this ripple is coupled into the output signals at a very low

amplitude, as seen in Figure 22. The ripple on the outputs is typically well below the noise floor of the signal.

There are two ways to further reduce the output supply noise:

- Add a 120Ω bead in series between  $V_{CC}$  and  $DV_{CC}$ . This reduces the coupling between the charge pump and the analog amplifier supplies.
- Add a 20pF capacitor between the back load 75Ω resistor and ground (see “ISL59833 + DC-Restore Solution” on page 10). This will attenuate frequencies above 100MHz.

The system operates at sufficiently high frequencies that any related charge pump noise is far beyond standard video bandwidth requirements. Still, appropriate bypassing discipline must be observed, and all pins related to either the power supply or the charge pump must be properly bypassed. See “Power Supply Bypassing and Printed Circuit Board Layout” on page 14.

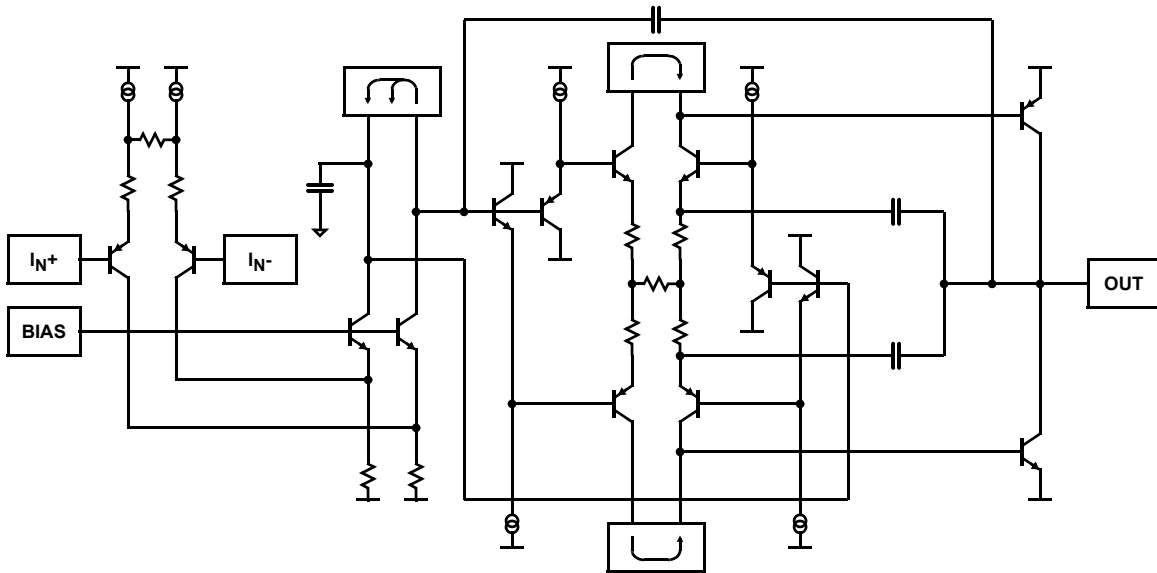

FIGURE 27. SIMPLIFIED SCHEMATIC

## THE VREF PIN

Applying a voltage to the VREF pin simply places that voltage on what would usually be the ground side of the gain resistor of the amplifier, resulting in a DC-level shift of the output signal. Applying 100mV to the VREF pin would apply a -100mV DC level shift to the outgoing signal. The charge pump provides sufficient bottom room to accommodate the shifted signal. VREF may be connected to ground for back porch at ground.

The ISL59833 buffers the VREF voltage before applying it to the triple amplifiers, isolating the input from the amplifiers and allowing it to be driven by moderate-impedance voltage sources.

## THE VEE PIN

The VEE pin is the output pin for the charge pump. A voltmeter applied to this pin will display the output of the charge pump. This pin does not affect the functionality of the part. One may use this pin as an additional voltage source. Keep in mind that the output of this pin is generated by the internal charge pump and a fully regulated supply that must be properly bypassed. We recommend a 0.1µF ceramic capacitor placed as close to the pin and connected to the ground plane of the board.

## INPUT, OUTPUT AND SUPPLY VOLTAGE RANGE

The ISL59833 is designed to operate with a single supply voltage range of from 0V to 3.3V. The need for a split supply has been eliminated with the incorporation of a charge pump capable of generating a bottom rail as much as 1.6V below ground, for a 4.9V range on a single 3.3V supply. This performance is ideal for NTSC video with its negative-going sync pulses.

## VIDEO PERFORMANCE

For good video performance, an amplifier is required to maintain the same output impedance and the same frequency and phase response as DC levels are changed at the output. This is especially difficult when driving a standard video load of 150Ω because of the change in output current with changing DC levels. Special circuitry has been incorporated into the ISL59833 for the reduction of output impedance variation with the current output. This results in outstanding differential gain and differential phase specifications of 0.06% and 0.1°, while driving 150Ω at a gain of +2. Driving higher impedance loads would result in similar or better differential gain and differential phase performance.

## NTSC

The ISL59833 (generating a negative rail internally) is ideally suited for NTSC video with its accompanying negative-going sync signals, which is easily handled by the ISL59833 without the need for an additional supply as the ISL59833 generates a negative rail with an internal charge pump referenced at negative 1/2 the positive supply.

## YPbPr

YPbPr signals originating from a DVD player requiring three channels of very tightly-controlled amplifier gain accuracy present no difficulty for the ISL59833. Specifically, this standard encodes sync on the Y channel and it is a negative-going signal, which is easily handled by the ISL59833 without the need for an additional supply as the ISL59833 generates a negative rail placed at negative 1/2 the positive supply. Additionally, the Pb and Pr are bipolar analog signals and the video signals are negative-going, and again, easily handled by the ISL59833.

## DRIVING CAPACITIVE LOADS AND CABLES

The ISL59833 (internally-compensated to drive 75Ω cables) will drive 10pF loads in parallel with 1kΩ with less than 5dB of peaking. If less peaking is required, a small series resistor, usually between 5Ω to 50Ω, can be placed in series with the output. This will reduce peaking at the expense of a slight closed loop gain reduction. When used as a cable driver, double termination is always recommended for reflection-free performance. For those applications, a back-termination series resistor at the amplifier's output will isolate the amplifier from the cable and allow extensive capacitive drive. However, other applications may have high capacitive loads without a back-termination resistor. Again, a small series resistor at the output can help to reduce peaking. The ISL59833 is a triple amplifier designed to drive three channels; simply deal with each channel separately as described in this section.

## DC-RESTORE

When the ISL59833 is AC-coupled it becomes necessary to restore the DC reference for the signal. This is accomplished with a DC-restore system applied between the capacitive "AC" coupling and the input of the device. Refer to "ISL59833 + DC-Restore Solution" on page 10.

## AMPLIFIER DISABLE

The ISL59833 can be disabled and its output placed in a high impedance state. The turn-off time is around 25ns and the turn-on time is around 200ns. When disabled, the amplifier's supply current is reduced to 80mA typically, reducing power consumption. The amplifier's power-down can be controlled by standard TTL or CMOS signal levels at the  $\overline{\text{EN}}$  pin. The applied logic signal is relative to the GND pin. Letting the  $\overline{\text{EN}}$  pin float or applying a signal that is less than 0.8V above GND will enable the amplifier. The amplifier will be disabled when the signal at  $\overline{\text{EN}}$  pin is 2V above GND. The  $V_{\text{EE}}$  charge pump remains active.

## OUTPUT DRIVE CAPABILITY

The ISL59833 does not have internal short-circuit protection circuitry. A short-circuit current of 80mA sourcing and 150mA sinking for the output is connected half way between the rails with a 10Ω resistor. If the output is shorted indefinitely, the power dissipation could easily increase such that the part will be destroyed. Maximum reliability is maintained if the output

current never exceeds  $\pm 40\text{mA}$ , after which the electro-migration limit of the process will be exceeded and the part will be damaged. This limit is set by the design of the internal metal interconnections.

### POWER DISSIPATION

With the high output drive capability of the ISL59837, it is possible to exceed the  $+150^\circ\text{C}$  absolute maximum junction temperature under certain load current conditions. Therefore, it is important to calculate the maximum junction temperature for an application to determine if load conditions or package types need to be modified to assure operation of the amplifier in a safe operating area.

The maximum power dissipation allowed in a package is determined according to:

$$P_{D_{MAX}} = \frac{T_{J_{MAX}} - T_{A_{MAX}}}{\Theta_{JA}} \quad (\text{EQ. 1})$$

Where:

$T_{J_{MAX}}$  = Maximum junction temperature

$T_{A_{MAX}}$  = Maximum ambient temperature

$\Theta_{JA}$  = Thermal resistance of the package

The maximum power dissipation actually produced by an IC is the total quiescent supply current times the total power supply voltage, plus the power in the IC due to the load, or:

for sourcing:

$$P_{D_{MAX}} = V_S \times I_{S_{MAX}} + (V_S - V_{OUT^i}) \times \frac{V_{OUT^i}}{R_L^i} \quad (\text{EQ. 2})$$

for sinking:

$$P_{D_{MAX}} = V_S \times I_{S_{MAX}} + (V_{OUT^i} - V_S) \times I_{LOAD^i} \quad (\text{EQ. 3})$$

Where:

$V_S$  = Supply voltage

$I_{S_{MAX}}$  = Maximum quiescent supply current

$V_{OUT}$  = Maximum output voltage of the application

$R_{LOAD}$  = Load resistance tied to ground

$I_{LOAD}$  = Load current

$i$  = Number of output channels

By setting the two  $P_{D_{MAX}}$  equations equal to each other, we can solve the output current and  $R_{LOAD}$  to avoid the device overheat.

### Power Supply Bypassing and Printed Circuit Board Layout

Strip line design techniques are recommended for the input and output signal traces. As with any high frequency device, a good printed circuit board layout is necessary for optimum performance. Lead lengths should be as short as possible. The power supply pin must be well bypassed to reduce the risk of oscillation. For normal single supply operation, where the  $V_{S-}$  pin is connected to the ground plane, a single  $4.7\mu\text{F}$  tantalum capacitor in parallel with a  $0.1\mu\text{F}$  ceramic capacitor from  $V_{S+}$  to GND will suffice. This same capacitor combination should be placed at each supply pin to ground if split-internal supplies are to be used. In this case, the  $V_{S-}$  pin becomes the negative supply rail.

For good AC performance, parasitic capacitance should be kept to a minimum. Use of wire-wound resistors should be avoided because of their additional series inductance. Use of sockets should also be avoided if possible. Sockets add parasitic inductance and capacitance can result in compromised performance. Minimizing parasitic capacitance at the amplifier's inverting input pin is also very important.