

ISL76671

Low Power, <100 Lux Optimized, Analog Output Ambient Light Sensor

FN7716
Rev.4.0
May 21, 2021

The [ISL76671](#) is a low cost, light-to-voltage silicon optical sensor combining a photodiode array, a non-linear current amplifier and a micro-power op amp on a single monolithic IC. Similar to the human eye, the photodiode array has peak sensitivity at 550nm and spans the wavelength range 400nm to 600nm, rejecting UV and IR light. The input luminance range is from 0.01 lux to 100 lux.

The integrated non-linear current amplifier boosts and converts the photodiode signal into a square root output format, extending dynamic range while maintaining excellent sensitivity in dimly lit conditions. As such, the part is ideal for measuring incident daylight when mounted behind heavily smoked bezels used around displays or behind mirrors.

The device consumes minimum power. A dark current compensation circuit minimizes the effect of temperature dependent leakage currents in the absence of light, improving the light sensitivity at low lux levels. The output gain has been optimized to require a relatively low value external bias resistor that falls within recommended automotive EMI limits. The built-in 1µA op amp gives the ISL76671 an output voltage driving advantage for heavier loads that can drive an ADC directly.

The ISL76671 is housed in an ultra compact 2mmx2.1mm ODFN plastic surface mount package. Operation is rated from -40°C to +105°C, Grade 2 per AEC-Q100.

Features

- Square root voltage output
- 0.01 lux to 100 lux range
- 1.8V to 3V supply range
- Close to human eye spectral response
- Fast response time
- Internal temperature compensation
- Good IR rejection
- Low supply current
- Operating temperature range -40°C to +105°C
- 6 Ld ODFN: 2mmx2.1mmx0.7mm
- Pb-free (RoHS compliant)
- [AEC-Q100](#) Qualified

Applications

- Display backlight control - central info display and instrumentation
- Anti-glare mirror systems - specified to operate behind Bezel mounting

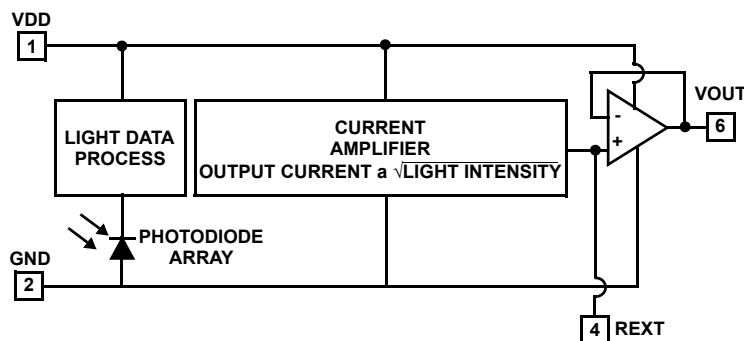
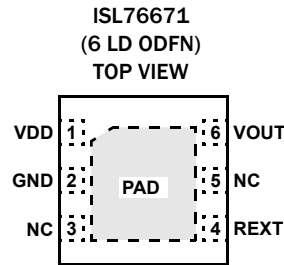

FIGURE 1. SIMPLIFIED BLOCK DIAGRAM

Pin Configuration



Pin Descriptions

PIN NUMBER	PIN NAME	PIN DESCRIPTION
1	VDD	Voltage Supply (1.8V to 3V).
2	GND	Ground
3, 5	NC	No connect
4	REXT	Connected to an external resistor to GND, setting the light-to-voltage scaling constant. A R_{EXT} value of 100k Ω is recommended.
6	VOUT	Voltage Output.
-	PAD	Thermal Pad. The thermal pad can be connected to GND or electrically isolated.

Ordering Information

PART NUMBER (Notes 2, 3)	PACKAGE DESCRIPTION (RoHS Compliant)	PKG. DWG. #	CARRIER TYPE (Note 1)	TEMP RANGE
ISL76671AR0Z-T7	6 Ld ODFN	L6.2X2.1Z	Reel, 3k	-40 to *105°C
ISL76671AR0Z-T7A			Reel, 250	
ISL76671EVAL1Z	Evaluation Board			

NOTES:

- See [TB347](#) for details about reel specifications.
- These Pb-free plastic packaged products employ special Pb-free material sets; molding compounds/die attach materials and NiPdAu plate -e4 termination finish, which is RoHS compliant and compatible with both SnPb and Pb-free soldering operations. Pb-free products are MSL classified at Pb-free peak reflow temperatures that meet or exceed the Pb-free requirements of IPC/JEDEC J STD-020.
- For Moisture Sensitivity Level (MSL), please see device information page for [ISL76671](#). For more information about MSL, see [TB477](#).

Absolute Maximum Ratings ($T_A = +25^\circ\text{C}$)

Supply Voltage Between V_{DD} and GND	3.6V
R_{EXT}	(-0.5V + GND) to (0.5V + V_{DD})
V_{OUT}	(-0.5V + GND) to (0.5V + V_{DD})
V_{OUT} Short Circuit Current	<10mA
ESD Rating	
Human Body Model (Tested per AEC-Q100-002)	2.5kV
Machine Model (Tested per AEC-Q100-003)	250V
Charged Device Model (Tested per AEC-Q100-011)	1kV
Latch-up (Tested per AEC-Q100-004, Class II, Level A)	100mA

Thermal Information

Thermal Resistance (Typical)	θ_{JA} ($^\circ\text{C}/\text{W}$)	θ_{JC} ($^\circ\text{C}/\text{W}$)
6 Ld ODFN (Notes 4, 5)	88	7.94
Maximum Die Temperature	+105 $^\circ\text{C}$	
Storage Temperature	-40 $^\circ\text{C}$ to +105 $^\circ\text{C}$	
Operating Temperature	-40 $^\circ\text{C}$ to +105 $^\circ\text{C}$	
Pb-Free Reflow Profile (*)	see TB477	
*Peak temperature during solder reflow +260 $^\circ\text{C}$ max		

CAUTION: Do not operate at or near the maximum ratings listed for extended periods of time. Exposure to such conditions can adversely impact product reliability and result in failures not covered by warranty.

NOTES:

- θ_{JA} is measured in free air with the component mounted on a high-effective thermal conductivity test board with direct attach features. See [TB379](#).
- For θ_{JC} , the case temperature location is the center of the exposed metal pad on the package underside.

Electrical Specifications Unless otherwise noted, all parameter limits are established over the recommended operating conditions: $V_{DD} = 3\text{V}$, $T_A = -40^\circ\text{C}$ to +105 $^\circ\text{C}$, $R_{EXT} = 100\text{k}\Omega$, no load at V_{OUT} , and green LED light. (Typical values are at $T_A = +25^\circ\text{C}$). **Boldface limits apply across the operating temperature range, -40 $^\circ\text{C}$ to +105 $^\circ\text{C}$.**

PARAMETER	DESCRIPTION	TEST CONDITIONS	MIN (Note 6)	TYP	MAX (Note 6)	UNITS
E	Range of Input Light Intensity for Square Root Relationship to be Held			0.01 - 100		Lux
V_{DD}	Operating Supply Voltage		1.8		3	V
I_{DD}	Supply Current	E = 0 lux, -40 $^\circ\text{C}$ to +60 $^\circ\text{C}$		0.7	2	μA
		E = 0 lux, -40 $^\circ\text{C}$ to +105 $^\circ\text{C}$			5	μA
		E = 100 lux		23	35	μA
V_{OUT}	Light-to-Voltage Accuracy	E = 10 lux		0.65		V
		E = 50 lux		1.35		V
		E = 100 lux	1.4	1.85	2.3	V
V_{DARK}	Voltage Output in the Absence of Light	E = 0 lux, -40 $^\circ\text{C}$ to +60 $^\circ\text{C}$		0.95	20	mV
		E = 0 lux, -40 $^\circ\text{C}$ to +105 $^\circ\text{C}$			120	mV
ΔV_{OUT}	Output Voltage Variation Over Three Light Sources: Fluorescent, Incandescent and Halogen			10		%
PSRR	Power Supply Rejection Ratio	E = 100 lux		0.12		mV/V
V_{O-CMPL}	Maximum Output Compliance Voltage at 95% of Nominal Output			$V_{DD} - 0.7\text{V}$		V
V_{O-MAX}	Maximum Output Voltage Swing				V_{DD}	V
t_R	Rise Time	E = 0 lux to 100 lux		95		μs
t_F	Fall Time	E = 100 lux to 0 lux		155		μs
t_D	Delay Time for Rising Edge	E = 0 lux to 100 lux		350		μs
t_S	Delay Time for Falling Edge	E = 100 lux to 0 lux		250		μs
ISC	Short Circuit Current of Op Amp			± 12		mA
SR	Slew Rate of Op Amp			13		V/ms
V_{OS}	Offset Voltage of Op Amp			± 0.9		mV

NOTE:

- Parameters with MIN and/or MAX limits are 100% tested at +25 $^\circ\text{C}$, unless otherwise specified. Temperature limits established by characterization and are not production tested.

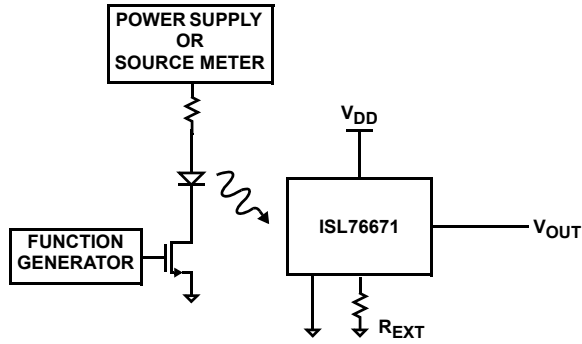

FIGURE 2. TEST CIRCUIT FOR RISE/FALL TIME MEASUREMENT

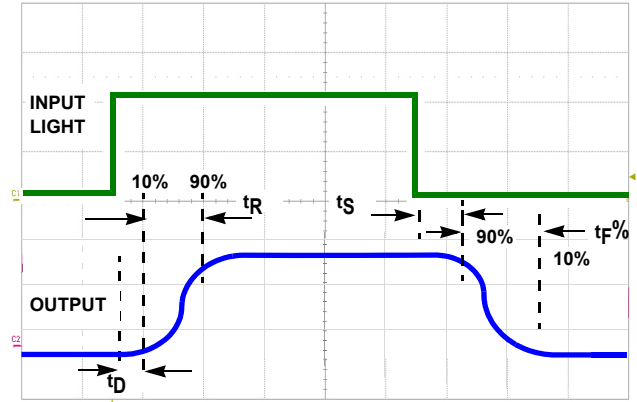

FIGURE 3. TIMING DIAGRAM

Typical Performance Curves

$V_{DD} = 3V$, $T_A = +25^\circ C$, $R_{EXT} = 100k\Omega$, no load at V_{OUT} , green LED light, unless otherwise specified.

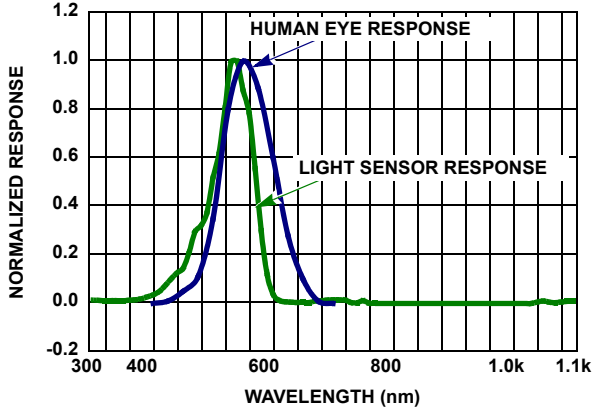

FIGURE 4. SPECTRAL RESPONSE

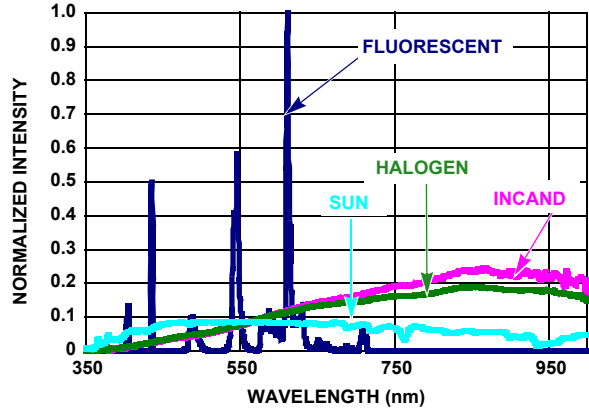

FIGURE 5. SPECTRUM OF FOUR LIGHT SOURCES NORMALIZED BY LUMINOUS INTENSITY (LUX)

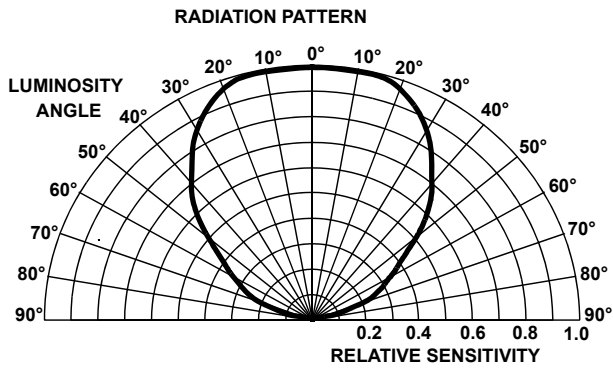

FIGURE 6. RADIATION PATTERN

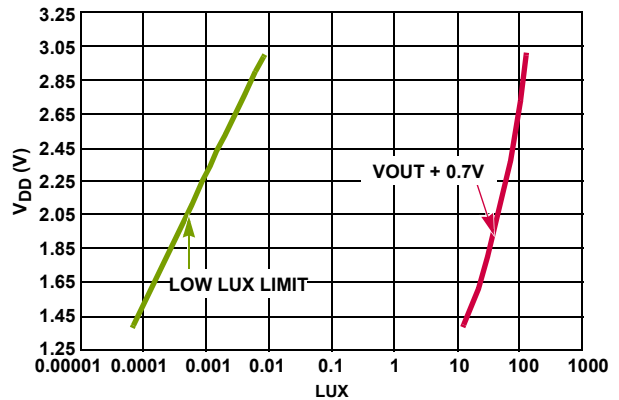

FIGURE 7. V_{DD} OPERATING RANGE (WHITE LED)

Typical Performance Curves $V_{DD} = 3V$, $T_A = +25^\circ C$, $R_{EXT} = 100k\Omega$, no load at V_{OUT} , green LED light, unless otherwise specified.

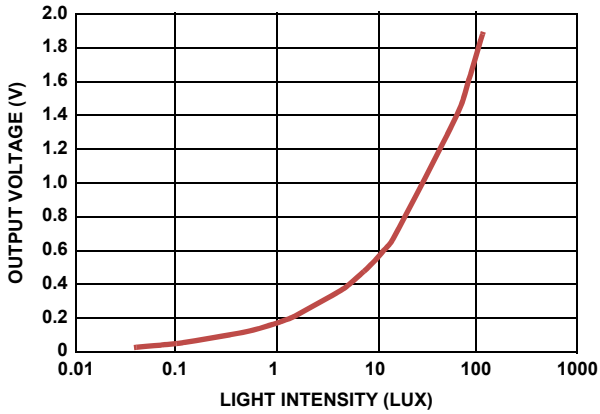

FIGURE 8. OUTPUT VOLTAGE vs LIGHT INTENSITY 0.1 LUX TO 100 LUX

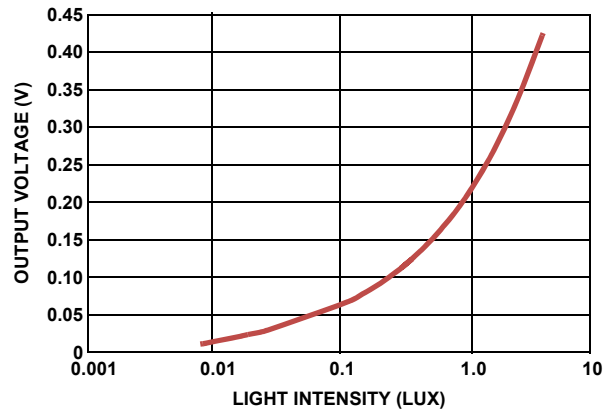

FIGURE 9. OUTPUT VOLTAGE vs LIGHT INTENSITY 0.01 LUX TO 5 LUX

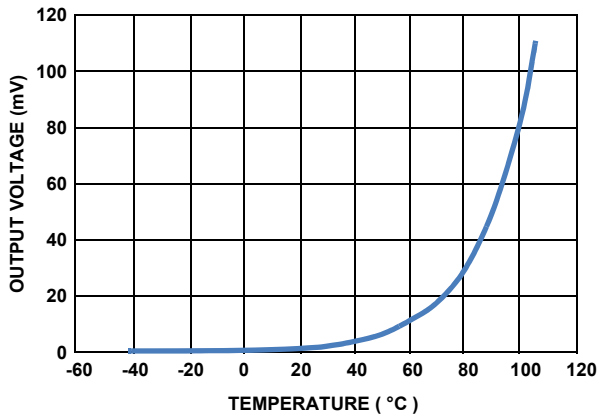

FIGURE 10. OUTPUT VOLTAGE vs TEMPERATURE AT 0 LUX

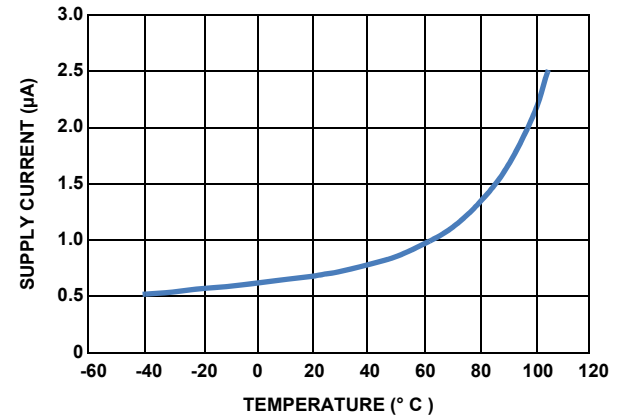

FIGURE 11. SUPPLY CURRENT vs TEMPERATURE AT 0 LUX

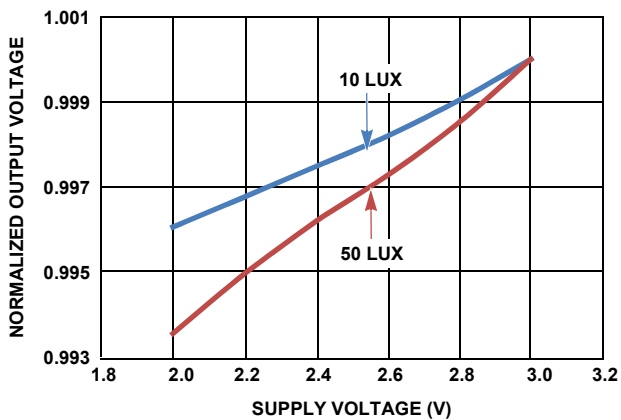

FIGURE 12. NORMALIZED OUTPUT VOLTAGE vs SUPPLY VOLTAGE

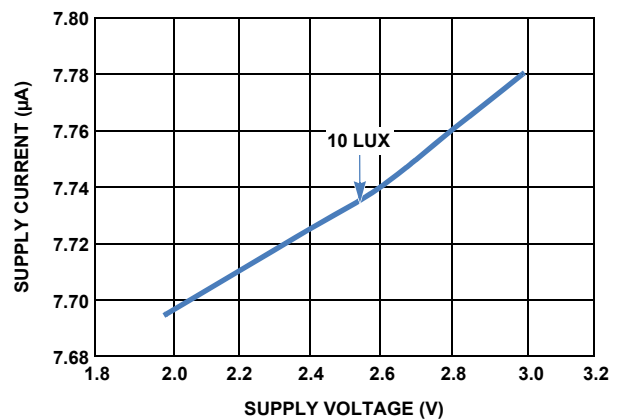

FIGURE 13. SUPPLY CURRENT vs SUPPLY VOLTAGE

Typical Performance Curves $V_{DD} = 3V, T_A = +25^\circ C, R_{EXT} = 100k\Omega$, no load at V_{OUT} , green LED light, unless otherwise specified.

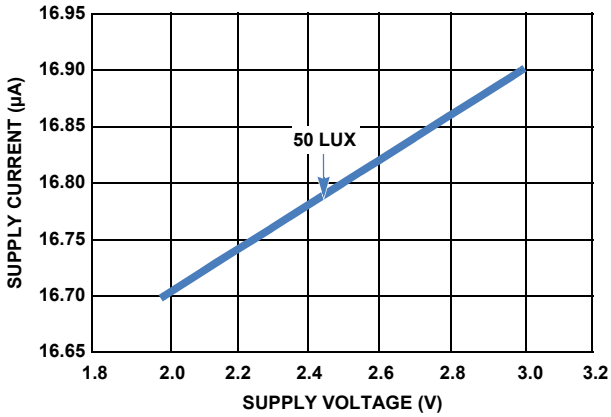

FIGURE 14. SUPPLY CURRENT vs SUPPLY VOLTAGE

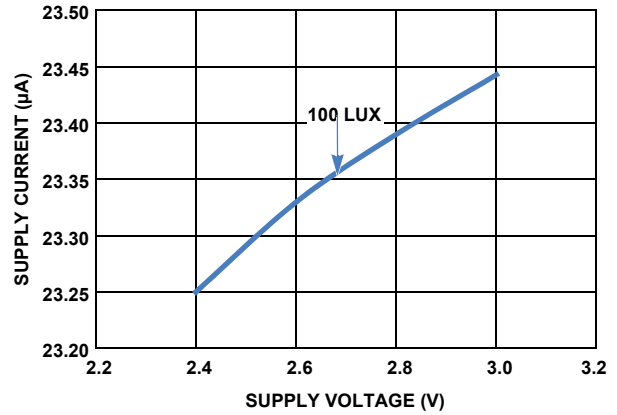

FIGURE 15. SUPPLY CURRENT vs SUPPLY VOLTAGE

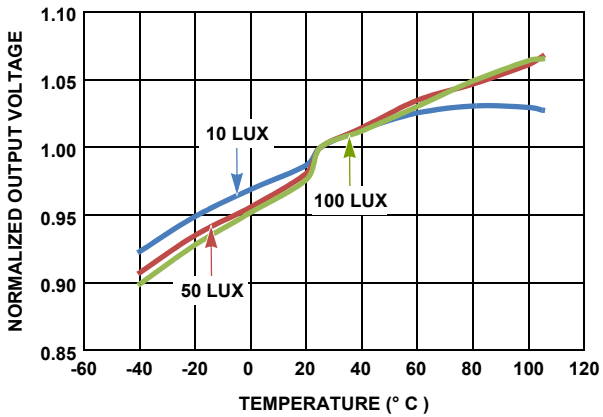

FIGURE 16. NORMALIZED OUTPUT VOLTAGE vs TEMPERATURE

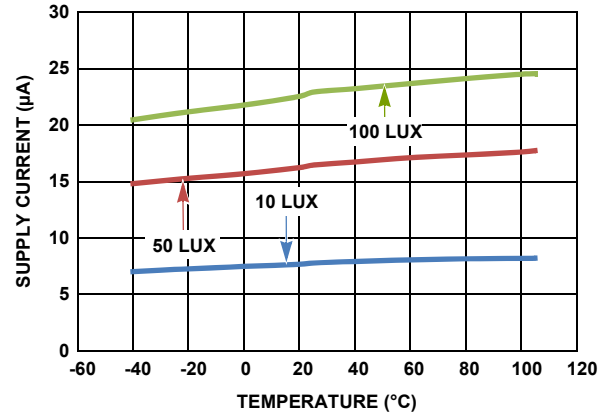

FIGURE 17. SUPPLY CURRENT vs TEMPERATURE

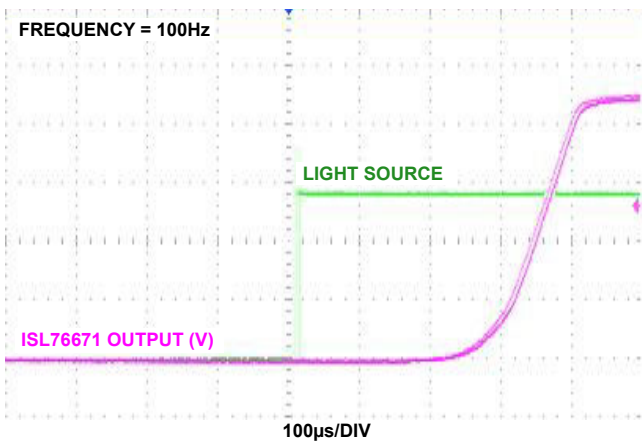

FIGURE 18. DELAY TIME vs LUX CHANGE FROM 0 LUX

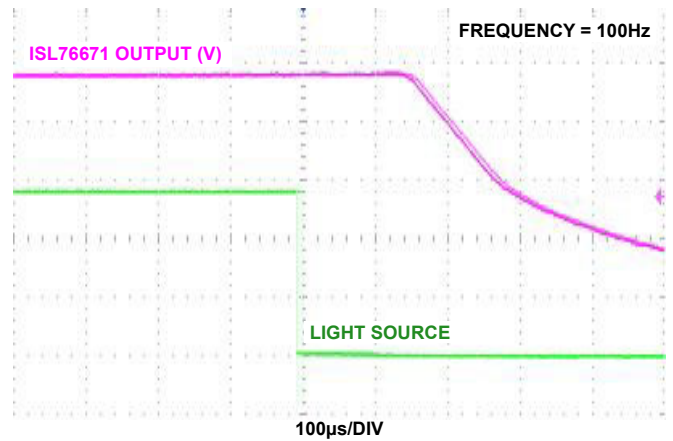

FIGURE 19. DELAY TIME vs LUX CHANGE TO 0 LUX

Application Information

Light-to-Voltage Conversion

The ISL76671 has responsiveness that is a square root function of the light intensity intercepted by the photodiode in lux.

Because the photodiode has a responsivity that resembles the human eye, conversion rate is independent of the light source (fluorescent light, incandescent light or direct sunlight).

$$V_{OUT} = \frac{18\mu A}{\sqrt{100\text{lux}}} \sqrt{E} \times R_{EXT} \quad (\text{EQ. 1})$$

In [Equation 1](#), V_{OUT} is the output voltage, E is the light intensity and R_{EXT} is the value of the external resistor. The R_{EXT} is used to set the light-to-voltage scaling constant. The compliance of the ISL76671's output circuit may result in premature saturation when an excessively large R_{EXT} is used. A R_{EXT} value of 100k Ω is recommended for automotive applications. The output compliance voltage is 700mV below the supply voltage as listed in V_{O-MAX} of the "Electrical Specifications" table on [page 3](#).

Optical Sensor Location Outline

The green area in [Figure 20](#) shows the optical sensor location outline of ISL76671. Along the pinout direction, the center line (CL) of the sensor coincides with that of the packaging. The sensor width in this direction is 0.39mm. Perpendicular to the pinout direction, the CL of the sensor has an 0.19mm offset from the CL of packaging away from pin 1. The sensor width in this direction is 0.46mm.

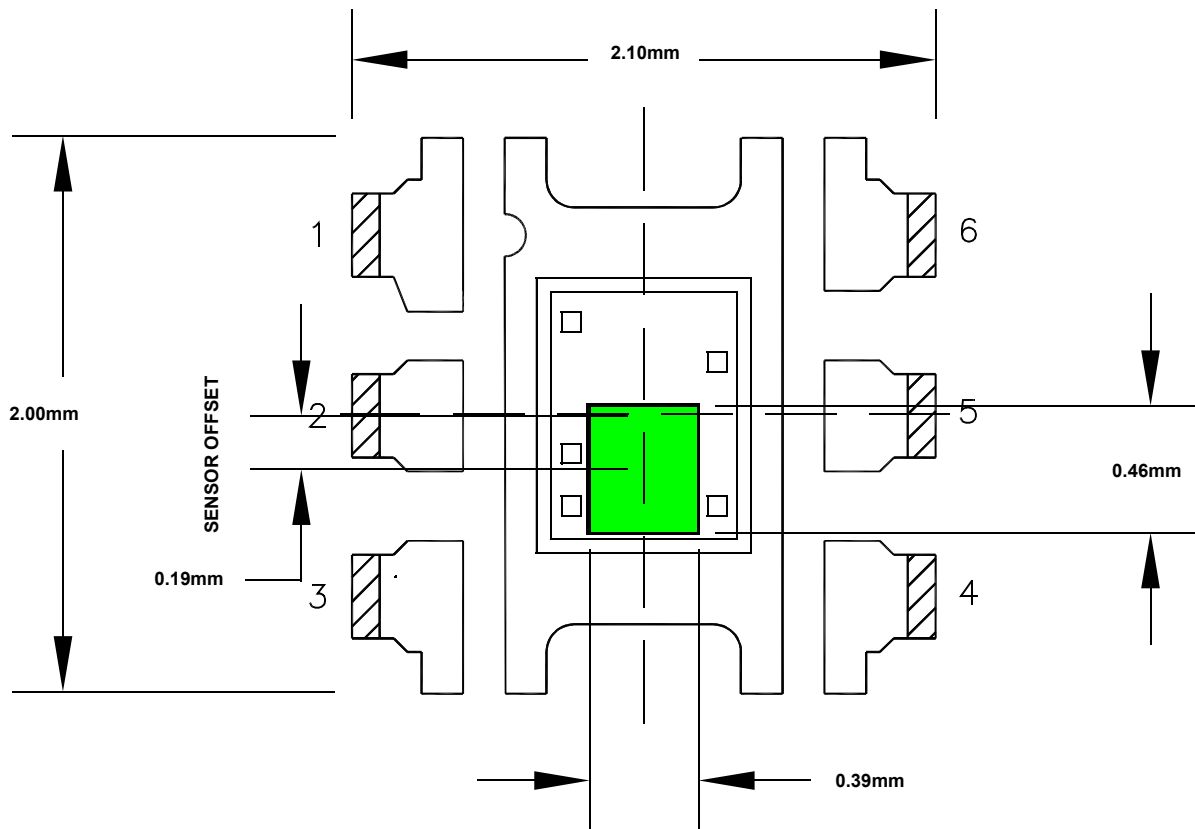

FIGURE 20. 6 LD ODFN SENSOR LOCATION OUTLINE

Revision History

The revision history provided is for informational purposes only and is believed to be accurate, but not warranted. Please go to web to make sure you have the latest revision.

DATE	REVISION	CHANGE
May 21, 2021	4.0	Updated Links throughout. Updated Ordering information table. Removed About Intersil section Replaced POD L6.2x2.1 with POD L6.2X2.1Z.
Apr 20, 2015	3.0	Changed AEC Q100 to AEC-Q100 Updated ordering information on page 2 by adding T7A part and Evaluation Board. Updated ESD Ratings in "Absolute Maximum Ratings ($T_A = +25^\circ\text{C}$)" on page 3 as follows: From: Human Body Model (Tested per JESD22-A114E)..... 3kV Machine Model (Tested per JESD22-A115C)..... 300V Charged Device Model (Tested per JESD22-C101E)..... 1kV Latch Up (Tested per JESD78C)..... 100mA To: Human Body Model (Tested per AEC-Q100-002)..... 2.5kV Machine Model (Tested per AEC-Q100-003)..... 250V Charged Device Model (Tested per AEC-Q100-011)..... 1kV Latch-up (Tested per AEC-Q100-004, Class II, Level A)..... 100mA Updated POD L6.2x2.1 to current rev with changes as follows: Changed Note 5 From: Tiebar shown (if present) is a non-functional feature. To: Tiebar shown (if present) is a non-functional feature and maybe located on any of the 4 sides (or ends). Updated Arrows to correct arrow type Updated datasheet with current Intersil standards.
December 23, 2013	2.0	Page 8 - 2nd line of the disclaimer changed from: "Intersil products are manufactured, assembled and tested utilizing ISO9001 quality systems as noted" to: "Intersil Automotive Qualified products are manufactured, assembled and tested utilizing TS16949 quality systems as noted"
December 12, 2011	1.0	"Thermal Information" on page 3, changed from: Pb-Free Reflow Profile (*) see TB487 *Peak temperature during solder reflow +235°C max To Pb-Free Reflow Profile (*) see TB477 *Peak temperature during solder reflow +260°C max "Electrical Specifications" on page 3: Added Min value of 1.4V and Max value of 2.3V for V_{OUT} where $e = 100$ lux
October 19, 2011	0.0	Initial Release

Package Outline Drawing

For the most recent package outline drawing, see [L6.2x2.1Z](#).

L6.2x2.1Z

6 Lead Optical Dual Flat No-Lead Plastic Package (ODFN)

Rev 0, 5/20

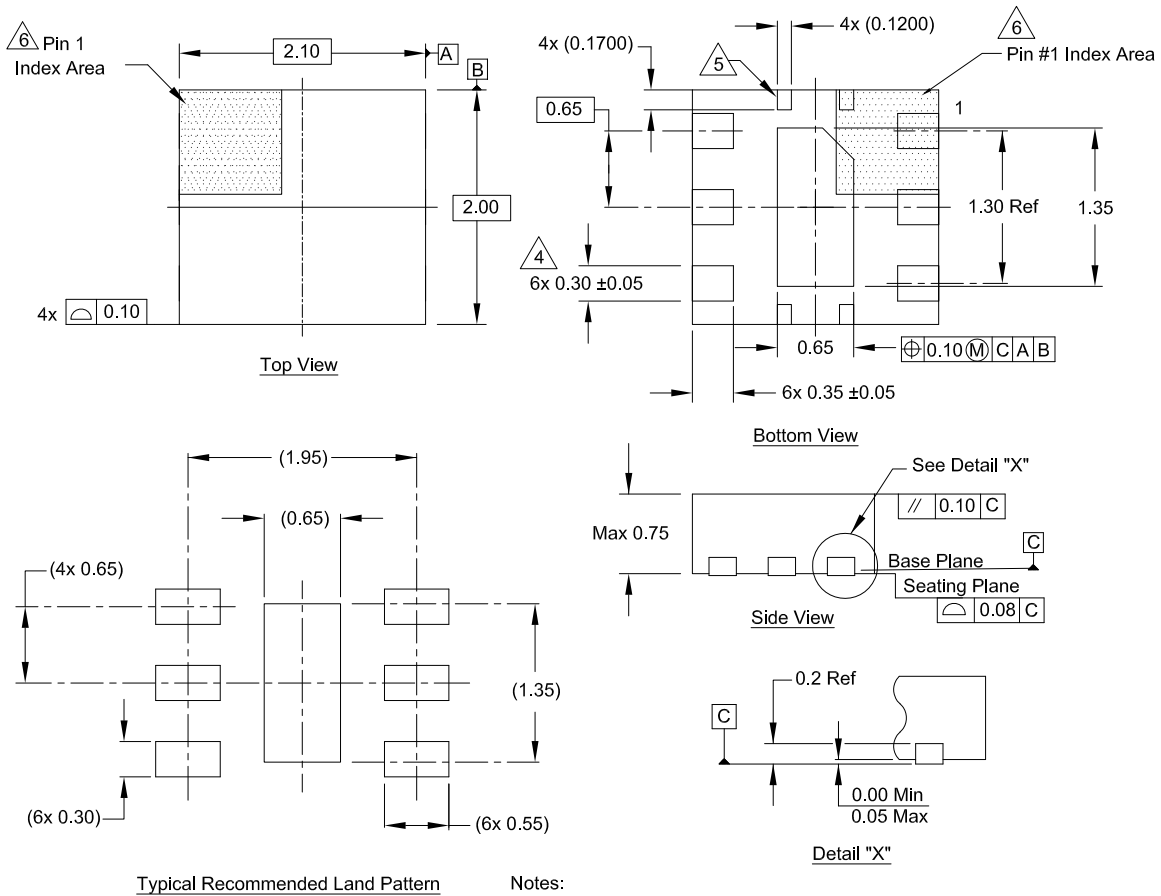

Notes:

1. Dimensions are in millimeters.
Dimensions in () for reference only.
2. Dimensioning and tolerancing conform to ASME Y14.5m-1994.
3. Unless otherwise specified, tolerance: Decimal ±0.05
- ④. Dimension applies to the metallized terminal and is measured between 0.15mm and 0.30mm from the terminal tip.
- ⑤. Tie bar shown (if present) is a non-functional feature connected to paddle for mechanical locking purpose.
- ⑥. The configuration of the pin #1 identifier is optional, but must be located within the zone indicated. The pin #1 identifier can be either a mold or mark feature.

Notice

1. Descriptions of circuits, software and other related information in this document are provided only to illustrate the operation of semiconductor products and application examples. You are fully responsible for the incorporation or any other use of the circuits, software, and information in the design of your product or system. Renesas Electronics disclaims any and all liability for any losses and damages incurred by you or third parties arising from the use of these circuits, software, or information.
2. Renesas Electronics hereby expressly disclaims any warranties against and liability for infringement or any other claims involving patents, copyrights, or other intellectual property rights of third parties, by or arising from the use of Renesas Electronics products or technical information described in this document, including but not limited to, the product data, drawings, charts, programs, algorithms, and application examples.
3. No license, express, implied or otherwise, is granted hereby under any patents, copyrights or other intellectual property rights of Renesas Electronics or others.
4. You shall be responsible for determining what licenses are required from any third parties, and obtaining such licenses for the lawful import, export, manufacture, sales, utilization, distribution or other disposal of any products incorporating Renesas Electronics products, if required.
5. You shall not alter, modify, copy, or reverse engineer any Renesas Electronics product, whether in whole or in part. Renesas Electronics disclaims any and all liability for any losses or damages incurred by you or third parties arising from such alteration, modification, copying or reverse engineering.
6. Renesas Electronics products are classified according to the following two quality grades: "Standard" and "High Quality". The intended applications for each Renesas Electronics product depends on the product's quality grade, as indicated below.

"Standard": Computers; office equipment; communications equipment; test and measurement equipment; audio and visual equipment; home electronic appliances; machine tools; personal electronic equipment; industrial robots; etc.

"High Quality": Transportation equipment (automobiles, trains, ships, etc.); traffic control (traffic lights); large-scale communication equipment; key financial terminal systems; safety control equipment; etc.

Unless expressly designated as a high reliability product or a product for harsh environments in a Renesas Electronics data sheet or other Renesas Electronics document, Renesas Electronics products are not intended or authorized for use in products or systems that may pose a direct threat to human life or bodily injury (artificial life support devices or systems; surgical implantations; etc.), or may cause serious property damage (space system; undersea repeaters; nuclear power control systems; aircraft control systems; key plant systems; military equipment; etc.). Renesas Electronics disclaims any and all liability for any damages or losses incurred by you or any third parties arising from the use of any Renesas Electronics product that is inconsistent with any Renesas Electronics data sheet, user's manual or other Renesas Electronics document.

7. No semiconductor product is absolutely secure. Notwithstanding any security measures or features that may be implemented in Renesas Electronics hardware or software products, Renesas Electronics shall have absolutely no liability arising out of any vulnerability or security breach, including but not limited to any unauthorized access to or use of a Renesas Electronics product or a system that uses a Renesas Electronics product. RENESAS ELECTRONICS DOES NOT WARRANT OR GUARANTEE THAT RENESAS ELECTRONICS PRODUCTS, OR ANY SYSTEMS CREATED USING RENESAS ELECTRONICS PRODUCTS WILL BE INVULNERABLE OR FREE FROM CORRUPTION, ATTACK, VIRUSES, INTERFERENCE, HACKING, DATA LOSS OR THEFT, OR OTHER SECURITY INTRUSION ("Vulnerability Issues"). RENESAS ELECTRONICS DISCLAIMS ANY AND ALL RESPONSIBILITY OR LIABILITY ARISING FROM OR RELATED TO ANY VULNERABILITY ISSUES. FURTHERMORE, TO THE EXTENT PERMITTED BY APPLICABLE LAW, RENESAS ELECTRONICS DISCLAIMS ANY AND ALL WARRANTIES, EXPRESS OR IMPLIED, WITH RESPECT TO THIS DOCUMENT AND ANY RELATED OR ACCOMPANYING SOFTWARE OR HARDWARE, INCLUDING BUT NOT LIMITED TO THE IMPLIED WARRANTIES OF MERCHANTABILITY, OR FITNESS FOR A PARTICULAR PURPOSE.
8. When using Renesas Electronics products, refer to the latest product information (data sheets, user's manuals, application notes, "General Notes for Handling and Using Semiconductor Devices" in the reliability handbook, etc.), and ensure that usage conditions are within the ranges specified by Renesas Electronics with respect to maximum ratings, operating power supply voltage range, heat dissipation characteristics, installation, etc. Renesas Electronics disclaims any and all liability for any malfunctions, failure or accident arising out of the use of Renesas Electronics products outside of such specified ranges.