

ISL78233, ISL78234

3A and 4A Compact Synchronous Buck Regulators

FN8359
Rev.11.00
Jan 20, 2022

The [ISL78233](#) and [ISL78234](#) are highly efficient, monolithic, synchronous step-down DC/DC converters that can deliver 3A (ISL78233), or 4A (ISL78234) of continuous output current from a 2.7V to 5.5V input supply. The devices use current mode control architecture to deliver a very low duty cycle operation at high frequency with fast transient response and excellent loop stability.

The ISL78233 and ISL78234 integrate a very low ON-resistance P-channel (35mΩ) high-side FET and N-channel (11mΩ) low-side FET to maximize efficiency and minimize external component count. The 100% duty-cycle operation allows less than 200mV dropout voltage at 4A output current. The operation frequency of the Pulse-Width Modulator (PWM) is adjustable from 500kHz to 4MHz. The default switching frequency of 2MHz is set by connecting the FS pin high.

The ISL78233 and ISL78234 can be configured for discontinuous or forced continuous operation at light load. Forced continuous operation reduces noise and RF interference, while discontinuous mode provides higher efficiency by reducing switching losses at light loads.

Fault protection is provided by internal Hiccup mode current limiting during short-circuit and overcurrent conditions. Other protection, such as overvoltage and over-temperature are also integrated into the device. A power-good output voltage monitor indicates when the output is in regulation.

The ISL78233 and ISL78234 offer a 1ms Power-Good (PG) timer at power-up. When in shutdown, the ISL78233 and ISL78234 discharge the output capacitor through an internal soft-stop switch. Other features include internal fixed or adjustable soft-start and internal/external compensation.

The ISL78233 and ISL78234 are available in a 3mmx3mm 16 Ld Thin Quad Flat (TQFN) Pb-free package and in a 5mmx5mm 16 Ld Wettable Flank Quad Flat No-Lead (WFQFN) package with an exposed pad for improved thermal performance. The ISL78233 and ISL78234 are rated to operate across the temperature range of -40 °C to +125 °C.

Features

- 2.7V to 5.5V input voltage range
- Very low ON-resistance FETs - P-channel 35mΩ and N-channel 11mΩ typical values
- High efficiency synchronous buck regulator with up to 95% efficiency
- -1.2%/1% reference accuracy over temperature/load/line
- Complete BOM with as few as 3 external parts
- Internal soft-start - 1ms or adjustable
- Soft-stop output discharge during disable
- Adjustable frequency from 500kHz to 4MHz - default at 2MHz
- External synchronization up to 4MHz
- Over-temperature, overcurrent, overvoltage, and negative overcurrent protection
- Shared common device pinout allows simplified output power upgrades over time
- Tiny 3mmx3mm TQFN package
- [AEC-Q100](#) qualified

Applications

- DC/DC POL modules
- μC/μP, FPGA, and DSP power
- Video processor/SOC power
- Li-ion battery powered devices
- Automotive infotainment power

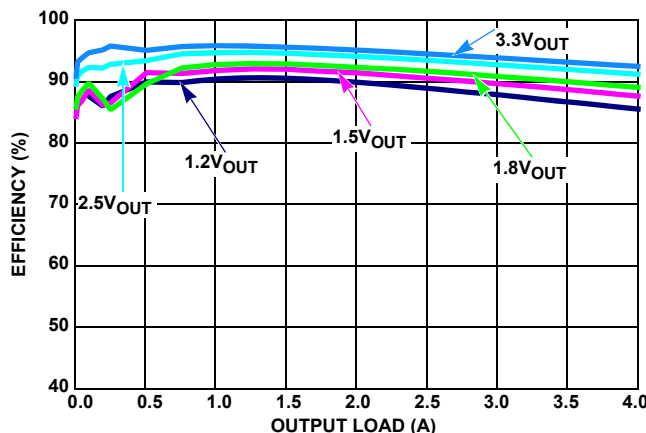

FIGURE 1. EFFICIENCY vs LOAD (2MHz 5V_{IN} PFM, T_A = +25 °C)

Table of Contents

Typical Application Diagram	3
Ordering Information	5
Pin Configuration	6
Pin Descriptions	6
Absolute Maximum Ratings (Reference to GND)	7
Thermal Information	7
Recommended Operating Conditions	7
Electrical Specifications	7
Typical Operating Performance	9
Theory of Operation	14
PWM Control Scheme	14
Skip Mode	14
Frequency Adjust	15
Overcurrent Protection	15
Negative Current Protection	15
PG	15
UVLO	15
Soft Start-Up	15
Enable	16
Discharge Mode (Soft-Stop)	16
Power MOSFETs	16
100% Duty Cycle	16
Thermal Shutdown	16
Applications Information	16
Output Inductor and Capacitor Selection	16
Output Voltage Selection	16
Input Capacitor Selection	16
Loop Compensation Design	16
PCB Layout Recommendation	18
Revision History	19
Package Outline Drawings	20

Typical Application Diagram

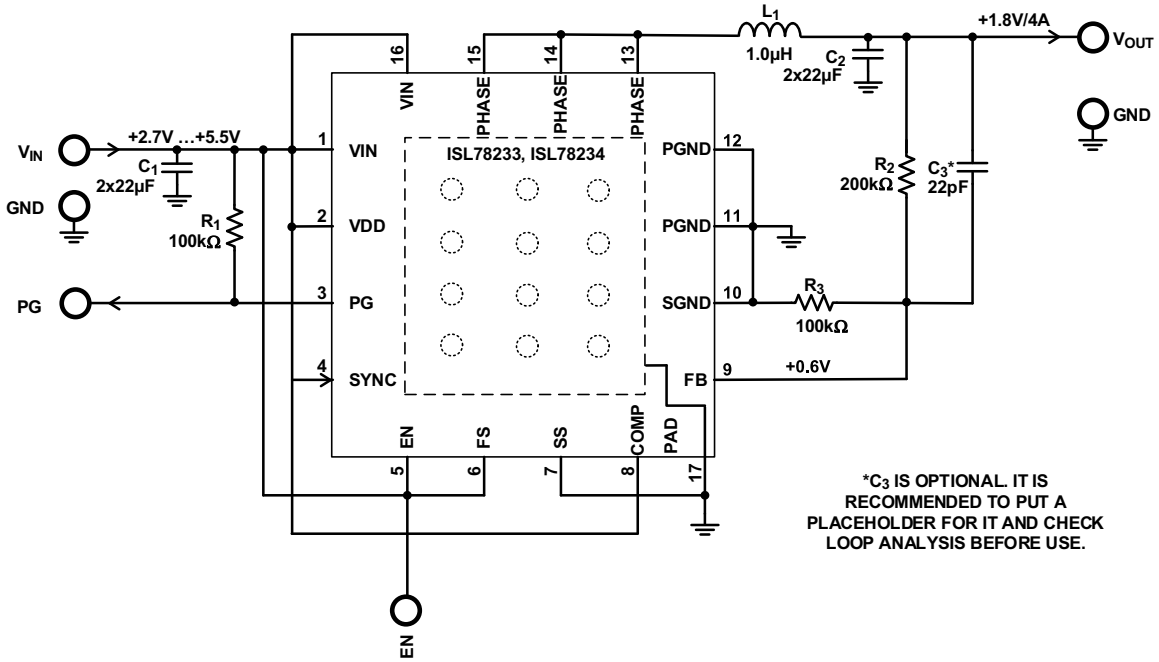

FIGURE 2. TYPICAL APPLICATION DIAGRAM

TABLE 1. COMPONENT SELECTION TABLE

V _{OUT}	1.2V	1.5V	1.8V	2.5V	3.3V	3.6V
C ₁	2 x 22µF	2 x 22µF	2 x 22µF	2 x 22µF	2 x 22µF	2 x 22µF
C ₂	2 x 22µF	2 x 22µF	2 x 22µF	2 x 22µF	2 x 22µF	2 x 22µF
C ₃	22pF	22pF	22pF	22pF	22pF	22pF
L ₁	0.33-0.68µH	0.33-0.68µH	0.33-0.68µH	0.47-0.78µH	0.47-0.78µH	0.47-0.78µH
R ₂	100kΩ	150kΩ	200kΩ	316kΩ	450kΩ	500kΩ
R ₃	100kΩ	100kΩ	100kΩ	100kΩ	100kΩ	100kΩ

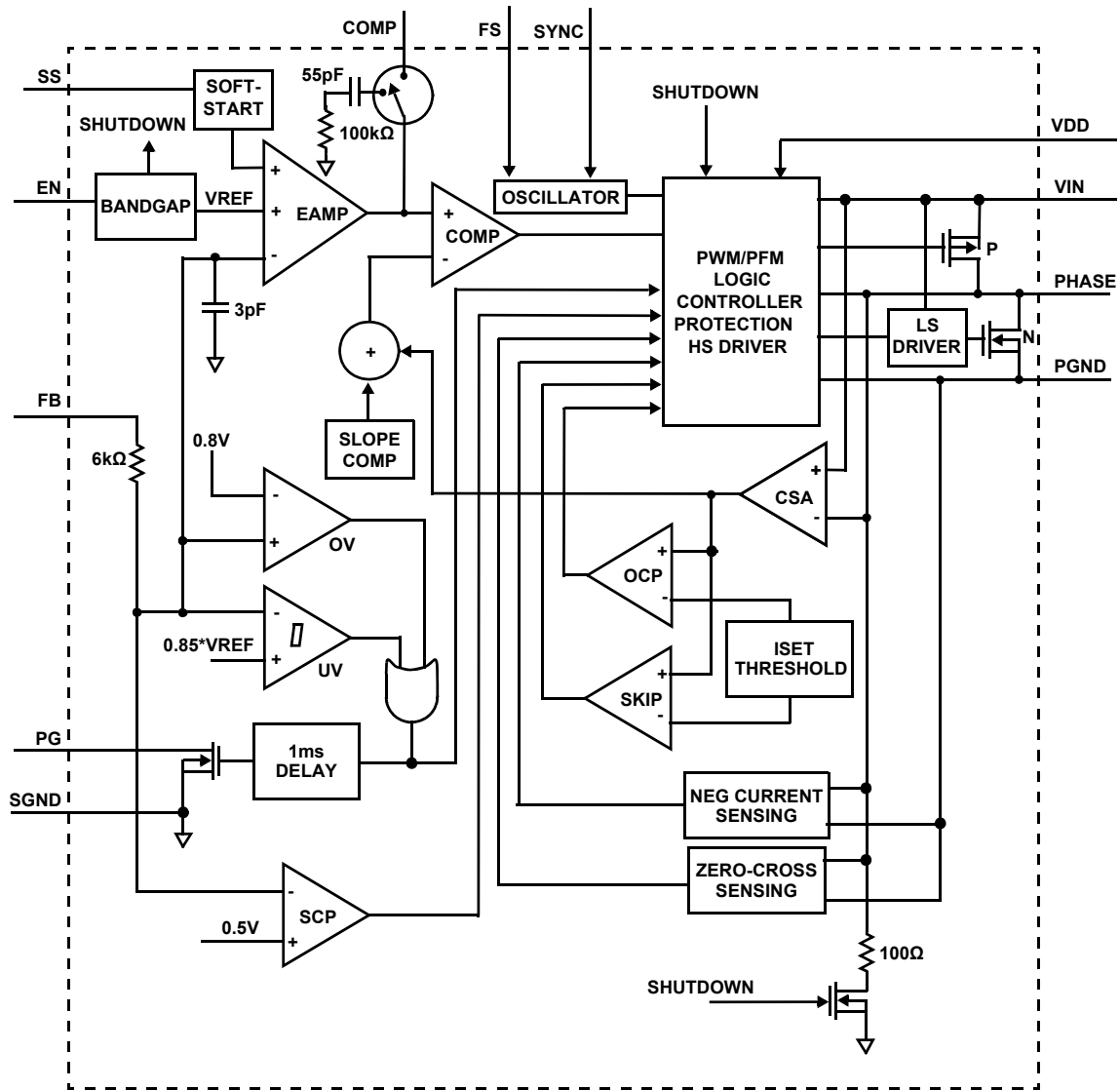

FIGURE 3. FUNCTIONAL BLOCK DIAGRAM

Ordering Information

PART NUMBER (Note 4)	PART MARKING	OUTPUT VOLTAGE (V)	PACKAGE DESCRIPTION (RoHS Compliant)	PKG. DWG. #	CARRIER TYPE (Note 1)	TEMP. RANGE
ISL78233ARZ (Note 2)	8233	Adjustable	16 Ld 3x3 TQFN	L16.3x3D	Tube	-40 to +125 °C
ISL78233ARZ-T (Note 2)					Reel, 6k	
ISL78233ARZ-T7A (Note 2)					Reel, 250	
ISL78233AARZ (Note 3)	78233A ARZ		16 Ld 5x5mm WFQFN	L16.5x5D	Tube	
ISL78233AARZ-T (Note 3)					Reel, 6k	
ISL78233AARZ-T7A (Note 3)					Reel, 250	
ISL78233BARZ (Note 2)	8233		16 Ld 3x3 TQFN	L16.3x3D	Tube	
ISL78233BARZ-T (Note 2)					Reel, 6k	
ISL78233BARZ-T7A (Note 2)					Reel, 250	
ISL78234ARZ (Note 2)	8234		16 Ld 3x3 TQFN	L16.3x3D	-	
ISL78234ARZ-T (Note 2)					Reel, 6k	
ISL78234ARZ-T7A (Note 2)					Reel, 250	
ISL78234AARZ (Note 3)	78234A ARZ	16 Ld 5x5mm WFQFN	L16.5x5D	-		
ISL78234AARZ-T (Note 3)				Reel, 6k		
ISL78234AARZ-T7A (Note 3)				Reel, 250		
ISL78233EVAL1Z	3x3mm TQFN Evaluation Board					
ISL78234EVAL1Z	3x3mm TQFN Evaluation Board					
ISL78233EVAL2Z	5x5mm WFQFN Evaluation Board					
ISL78234EVAL2Z	5x5mm WFQFN Evaluation Board					

NOTES:

- See [TB347](#) for details about reel specifications.
- These Pb-free plastic packaged products employ special Pb-free material sets, molding compounds/die attach materials, and 100% matte tin plate plus anneal (e3 termination finish, which is RoHS compliant and compatible with both SnPb and Pb-free soldering operations). Pb-free products are MSL classified at Pb-free peak reflow temperatures that meet or exceed the Pb-free requirements of IPC/JEDEC J STD-020.
- These Pb-free plastic packaged products employ special Pb-free material sets; molding compounds/die attach materials and NiPdAu-Ag plate - e4 termination finish, which is RoHS compliant and compatible with both SnPb and Pb-free soldering operations. Pb-free products are MSL classified at Pb-free peak reflow temperatures that meet or exceed the Pb-free requirements of IPC/JEDEC J STD-020.
- For Moisture Sensitivity Level (MSL), see the [ISL78233](#), [ISL78234](#) device information pages. For more information about MSL, see [TB363](#).

TABLE 2. KEY DIFFERENCE BETWEEN FAMILY OF PARTS

PART NUMBER	I _{OUT} MAX (A)
ISL78233	3
ISL78234	4
ISL78235	5

Pin Configuration

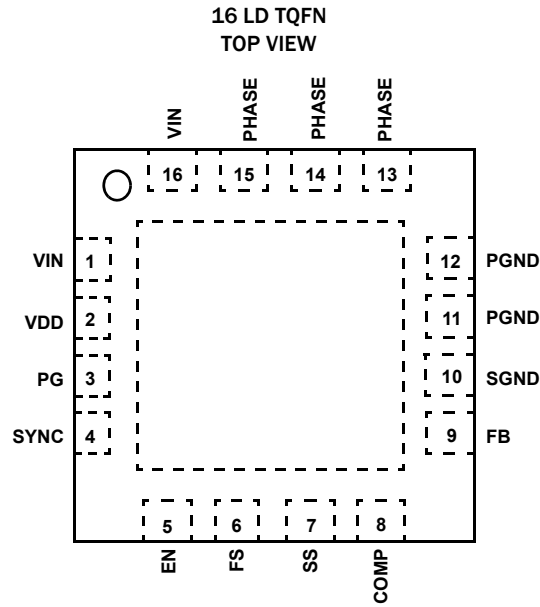

Pin Descriptions

PIN NUMBER	SYMBOL	DESCRIPTION
1, 16	VIN	Input supply voltage. Place a minimum of two 22µF ceramic capacitors from VIN to PGND as close as possible to the IC for decoupling.
2	VDD	Input supply voltage for logic. Connect to the VIN pin.
3	PG	Power-good is an open-drain output. Use a 10kΩ to 100kΩ pull-up resistor connected between VIN and PG. At power-up or EN HI, PG rising edge is delayed by 1ms upon output reached within regulation.
4	SYNC	Mode Selection pin. Connect to logic high or input voltage VIN for PWM mode. Connect to logic low or ground for PFM mode. Connect to an external function generator for synchronization with the positive edge trigger. There is an internal 1MΩ pull-down resistor to prevent an undefined logic state in case of SYNC pin float.
5	EN	Regulator enable pin. Enable the output when driven to high. Shutdown the chip and discharge output capacitor when driven to low.
6	FS	This pin sets the oscillator switching frequency, using a resistor, RFS, from the FS pin to GND. The frequency of operation may be programmed between 500kHz to 4MHz. The default frequency is 2MHz if FS is connected to VIN.
7	SS	SS is used to adjust the soft-start time. Set to SGND for internal 1ms rise time. Connect a capacitor from SS to SGND to adjust the soft-start time. Do not use more than 33nF per IC.
8	COMP	The feedback network of the regulator, FB, is the negative input to the transconductance error amplifier. COMP is the output of the amplifier if COMP is not tied to VDD. Otherwise, COMP is disconnected through a MOSFET for internal compensation. Must connect COMP to VDD in internal compensation mode. The output voltage is set by an external resistor divider connected to FB. With a properly selected divider, the output voltage can be set to any voltage between the power rail (reduced by converter losses) and the 0.6V reference. There is an internal compensation to meet a typical application. Additional external networks across COMP and SGND might be required to improve the loop compensation of the amplifier operation.
9	FB	In addition, the regulator power-good and undervoltage protection circuitry use FB to monitor the regulator output voltage.
10	SGND	Signal ground
11, 12	PGND	Power ground
13, 14, 15	PHASE	Switching node connections. Connect to one terminal of the inductor. This pin is discharged by a 100Ω resistor when the device is disabled. See "Functional Block Diagram" on page 4 for more detail.
Exposed Pad	-	The exposed pad must be connected to the SGND pin for proper electrical performance. Place as many vias as possible under the pad connecting to the SGND plane for optimal thermal performance.

Absolute Maximum Ratings (Reference to GND)

VIN	-0.3V to 5.8V (DC) or 7V (20ms)
EN, FS, PG, SYNC, VFB	-0.3V to VIN + 0.3V
PHASE	
DC:	-0.3V to 6.5V
Pulsed (Note 8):	-2V (< 0.6μJ) to 7V (20ms)
COMP, SS (Note 7)	-0.3V to 2.7V
ESD Rating	
Human Body Model (Tested per AEC-Q100-002)	5kV
Machine Model (Tested per AEC-Q100-003)	300V
Charge Device Model (Tested per AEC-Q100-011)	2kV
Latch-Up (Tested per AEC-Q100-004, Class II, Level A)	100mA

Thermal Information

Thermal Resistance	θ_{JA} (°C/W)	θ_{JC} (°C/W)
16 Ld TQFN Package (Notes 5, 6)	43	3.5
16 Ld WFQFN Package (Notes 5, 6)	33	3.5
Operating Junction Temperature Range	-55°C to +125°C	
Storage Temperature Range	-65°C to +150°C	
Pb-Free Reflow Profile	see TB493	

Recommended Operating Conditions

VIN Supply Voltage Range	2.7V to 5.5V
Load Current Range	
(ISL78233)	0A to 3A
(ISL78234)	0A to 4A
Ambient Temperature Range	-40°C to +125°C

CAUTION: Do not operate at or near the maximum ratings listed for extended periods of time. Exposure to such conditions can adversely impact product reliability and result in failures not covered by warranty.

NOTES:

- θ_{JA} is measured in free air with the component mounted on a high-effective thermal conductivity test board with direct attach features. See [TB379](#).
- θ_{JC} , case temperature location is at the center of the exposed metal pad on the package underside.
- COMP is an input and output pin. When the ISL7823x is used with an internal compensation, the COMP pin has a rating similar to VIN. When using the ISL7823x in an external compensation, the ratings are -0.3V to 2.7V.
- The PHASE pin negative voltage can be less than -2V as long as the energy of the pulse does not exceed 0.6μJ.

Electrical Specifications Unless otherwise noted, all parameter limits are established across the recommended operating conditions and the specification limits are measured at the following conditions: $T_A = -40^\circ\text{C}$ to $+125^\circ\text{C}$, $V_{IN} = 3.6\text{V}$, $EN = V_{IN}$, unless otherwise noted. Typical values are at $T_A = +25^\circ\text{C}$. **Boldface limits apply across the operating temperature range, -40°C to $+125^\circ\text{C}$.**

PARAMETER	SYMBOL	TEST CONDITIONS	MIN (Note 9)	TYP	MAX (Note 9)	UNIT
INPUT SUPPLY						
VIN Undervoltage Lockout Threshold	VUVLO	Rising, no load		2.5	2.7	V
		Falling, no load	2.2	2.45		V
Quiescent Supply Current	I _{VIN}	SYNC = GND, no load at the output		45		μA
		SYNC = GND, no load at the output and no switches switching		45	60	μA
		SYNC = V _{IN} , FS = 2MHz, no load at the output		19	25	mA
Shutdown Supply Current	I _{SD}	SYNC = GND, V _{IN} = 5.5V, EN = low		3.8	10	μA
OUTPUT REGULATION						
Reference Voltage	V _{REF}		0.593	0.600	0.606	V
VFB Bias Current	I _{VFB}	VFB = 0.75V		0.1		μA
Line Regulation		V _{IN} = V _O + 0.5V to 5.5V (minimal 2.7V)		0.2		%/V
Soft-Start Ramp Time Cycle		SS = SGND		1		ms
Soft-Start Charging Current	I _{SS}	V _{SS} = 0.1V	1.7	2.1	2.5	μA
OVERCURRENT PROTECTION						
Current Limit Blanking Time	t _{OCON}			17		Clock pulses
Overcurrent and Auto Restart Period	t _{OCCOFF}			8		SS cycle
Positive Peak Current Limit	I _{PLIMIT}	ISL78234, T _A = +25°C	5.4	6.7	8.1	A
		ISL78234, T _A = -40°C to +125°C	5.2		9	A
		ISL78233, T _A = +25°C	3.9	4.9	6	A
		ISL78233, T _A = -40°C to +125°C	3.7		6.6	A

Electrical Specifications Unless otherwise noted, all parameter limits are established across the recommended operating conditions and the specification limits are measured at the following conditions: $T_A = -40^\circ\text{C}$ to $+125^\circ\text{C}$, $V_{IN} = 3.6\text{V}$, $EN = V_{IN}$, unless otherwise noted. Typical values are at $T_A = +25^\circ\text{C}$. **Boldface limits apply across the operating temperature range, -40°C to $+125^\circ\text{C}$.** (Continued)

PARAMETER	SYMBOL	TEST CONDITIONS	MIN (Note 9)	TYP	MAX (Note 9)	UNIT
Peak Skip Limit	I_{SKIP}	ISL78234, $T_A = +25^\circ\text{C}$	0.9	1.1	1.35	A
		ISL78234, $T_A = -40^\circ\text{C}$ to $+125^\circ\text{C}$	0.84		1.5	A
		ISL78233, $T_A = +25^\circ\text{C}$	0.7	0.9	1.2	A
		ISL78233, $T_A = -40^\circ\text{C}$ to $+125^\circ\text{C}$	0.6		1.3	A
Zero Cross Threshold			-275		375	mA
Negative Current Limit	I_{NLIMIT}	$T_A = +25^\circ\text{C}$	-5.1	-2.8	-1.3	A
		$T_A = -40^\circ\text{C}$ to $+125^\circ\text{C}$	-6.0		-0.6	A
COMPENSATION						
Error Amplifier Transconductance		COMP = V_{DD} , internal compensation		125		$\mu\text{A/V}$
		External compensation		130		$\mu\text{A/V}$
Transresistance	RT	4A application	0.145	0.2	0.25	Ω
PHASE						
P-Channel MOSFET ON-Resistance		$V_{IN} = 5\text{V}$, $I_O = 200\text{mA}$	26	35	50	m Ω
		$V_{IN} = 2.7\text{V}$, $I_O = 200\text{mA}$	38	52	78	m Ω
N-Channel MOSFET ON-Resistance		$V_{IN} = 5\text{V}$, $I_O = 200\text{mA}$	5	11	20	m Ω
		$V_{IN} = 2.7\text{V}$, $I_O = 200\text{mA}$	8	15	31	m Ω
PHASE Maximum Duty Cycle				100		%
PHASE Minimum On-Time		SYNC = High			100	ns
OSCILLATOR						
Nominal Switching Frequency	f_{SW}	FS = V_{IN}	1700	2000	2350	kHz
		FS with RS = 402k Ω		420		kHz
		FS with RS = 42.2k Ω		4200		kHz
SYNC Logic LOW to HIGH Transition Range			0.67	0.75	0.84	V
SYNC Hysteresis				0.17		V
SYNC Logic Input Leakage Current		$V_{IN} = 3.6\text{V}$		3.7	5	μA
PG						
Output Low Voltage		IPG = 1mA			0.3	V
Delay Time (Rising Edge)		Time from V_{OUT} reached regulation	0.5	1	2	ms
PG Pin Leakage Current		PG = V_{IN}		0.01	0.1	μA
OVP PG Rising Threshold				0.80		V
UVP PG Rising Threshold			80	86	90	%
UVP PG Hysteresis				5.5		%
PGOOD Delay Time (Falling Edge)				6.5		μs
EN						
Logic Input Low (Note 10)	EN_VIL				0.4	V
Logic Input High	EN_VIH		0.9			V
EN Logic Input Leakage Current		Pulled up to 3.6V		0.1	1	μA
Thermal Shutdown		Temperature Rising		150		$^\circ\text{C}$
Thermal Shutdown Hysteresis		Temperature Falling		25		$^\circ\text{C}$

NOTE:

- Compliance to datasheet limits is assured by one or more methods: production test, characterization and/or design.
- EN should be held below the EN_VIL until V_{IN} exceeds V_{UVLO} rising.

Typical Operating Performance

Unless otherwise noted, operating conditions are: $T_A = +25^\circ\text{C}$, $V_{IN} = 5\text{V}$, $EN = V_{IN}$, $SYNC = V_{IN}$, $L = 1.0\mu\text{H}$, $C_1 = 22\mu\text{F}$, $C_2 = 2 \times 22\mu\text{F}$, $I_{OUT} = 0\text{A to } 4\text{A}$.

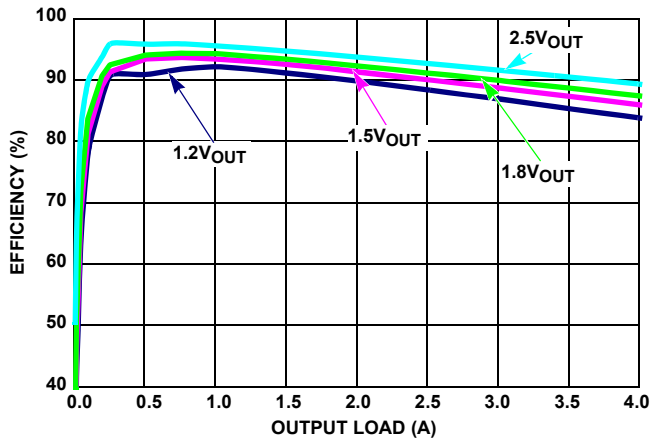

FIGURE 4. EFFICIENCY vs LOAD (2MHz, 3.3VIN PWM)

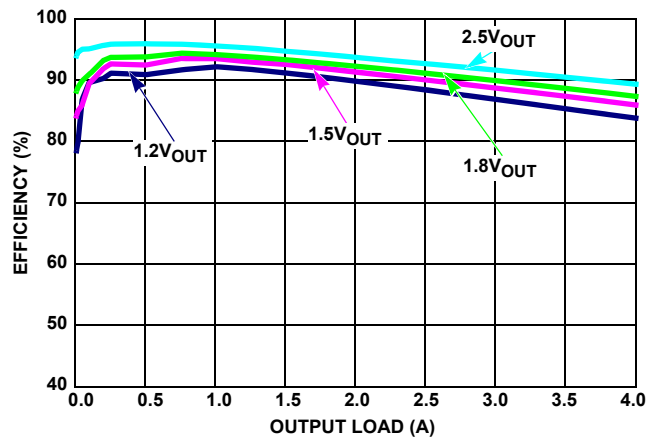

FIGURE 5. EFFICIENCY vs LOAD (2MHz, 3.3VIN PFM)

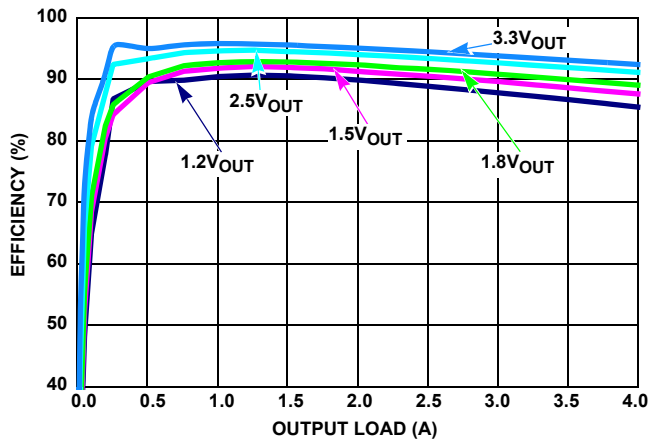

FIGURE 6. EFFICIENCY vs LOAD (2MHz, 5VIN PWM)

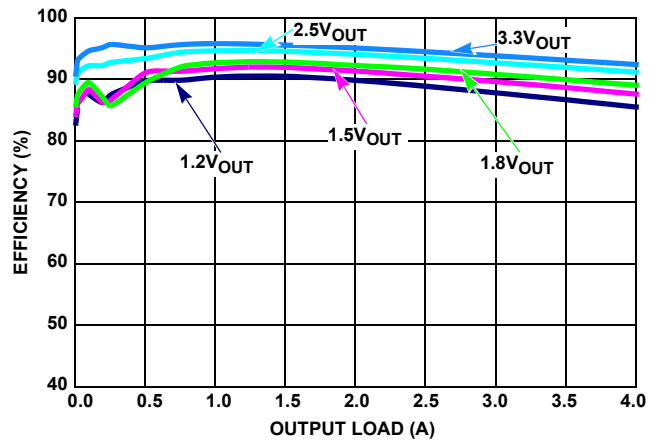

FIGURE 7. EFFICIENCY vs LOAD (2MHz, 5VIN PFM)

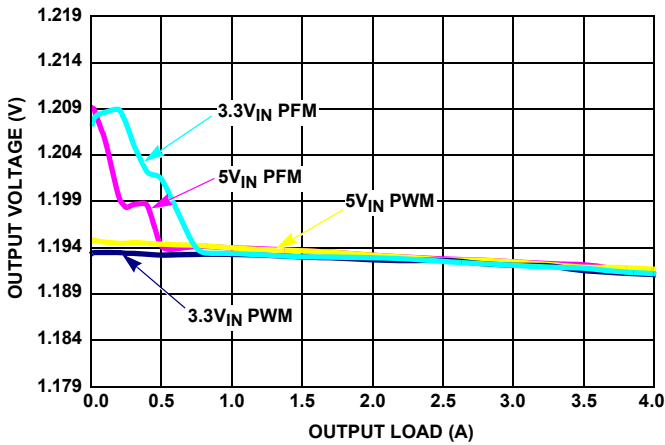

FIGURE 8. V_{OUT} REGULATION vs LOAD (1MHz, $V_{OUT} = 1.2\text{V}$)

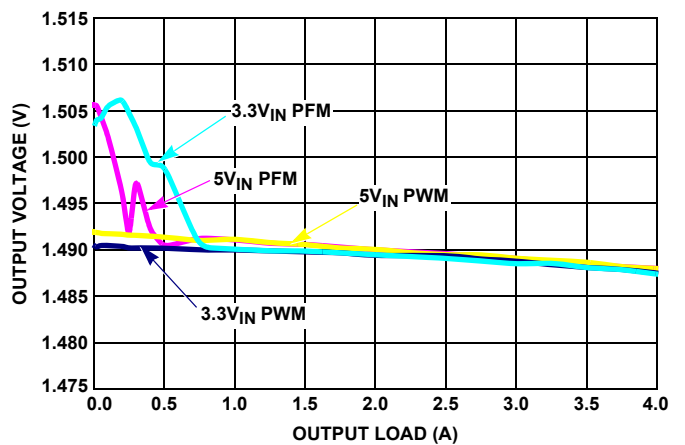

FIGURE 9. V_{OUT} REGULATION vs LOAD (1MHz, $V_{OUT} = 1.5\text{V}$)

Typical Operating Performance

Unless otherwise noted, operating conditions are: $T_A = +25^\circ\text{C}$, $V_{IN} = 5\text{V}$, $EN = V_{IN}$,

$SYNC = V_{IN}$, $L = 1.0\mu\text{H}$, $C_1 = 22\mu\text{F}$, $C_2 = 2 \times 22\mu\text{F}$, $I_{OUT} = 0\text{A to } 4\text{A}$. (Continued)

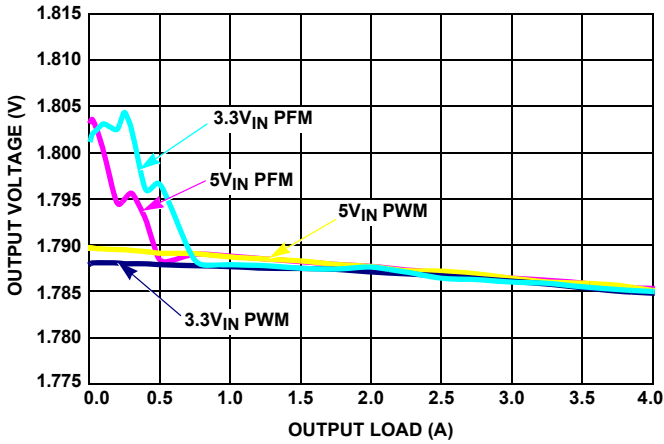

FIGURE 10. V_{OUT} REGULATION vs LOAD (1MHz, $V_{OUT} = 1.8\text{V}$)

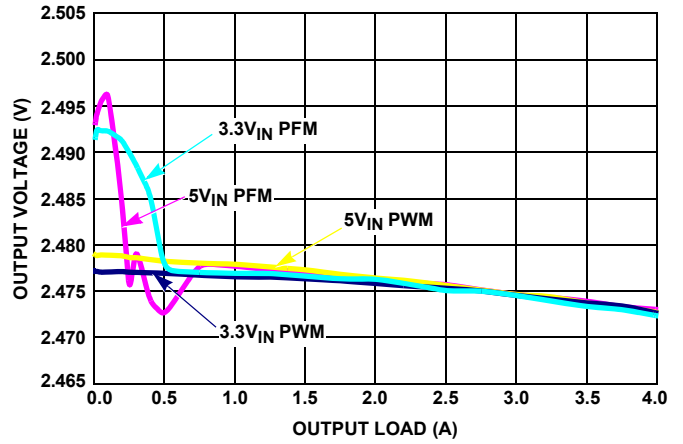

FIGURE 11. V_{OUT} REGULATION vs LOAD (1MHz, $V_{OUT} = 2.5\text{V}$)

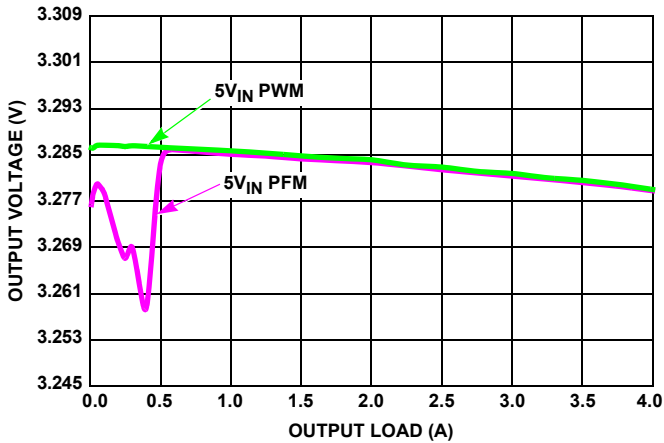

FIGURE 12. V_{OUT} REGULATION vs LOAD (1MHz, $V_{OUT} = 3.3\text{V}$)

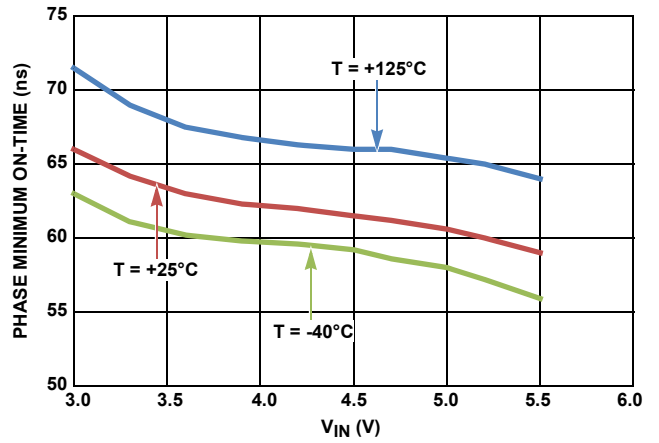

FIGURE 13. PHASE MINIMUM ON-TIME vs V_{IN} (2MHz)

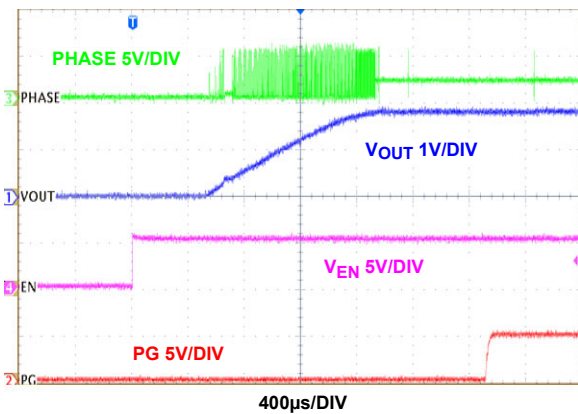

FIGURE 14. START-UP AT NO LOAD (PFM)

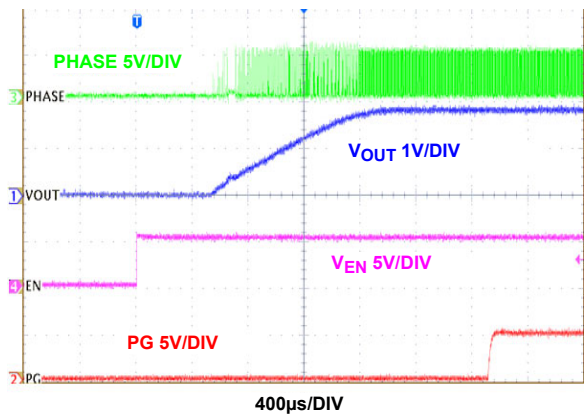

FIGURE 15. START-UP AT NO LOAD (PWM)

Typical Operating Performance

Unless otherwise noted, operating conditions are: $T_A = +25^\circ\text{C}$, $V_{IN} = 5\text{V}$, $EN = V_{IN}$, $SYNC = V_{IN}$, $L = 1.0\mu\text{H}$, $C_1 = 22\mu\text{F}$, $C_2 = 2 \times 22\mu\text{F}$, $I_{OUT} = 0\text{A to } 4\text{A}$. (Continued)

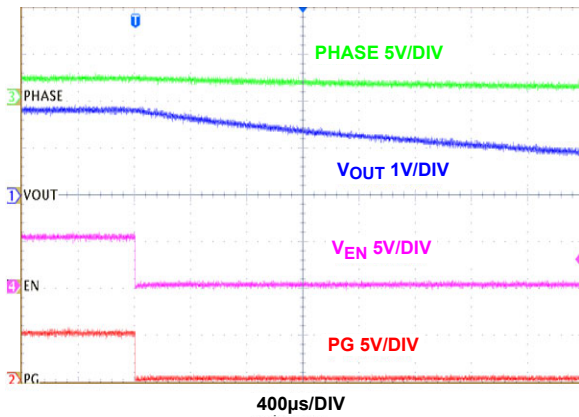

FIGURE 16. SHUTDOWN AT NO LOAD (PFM)

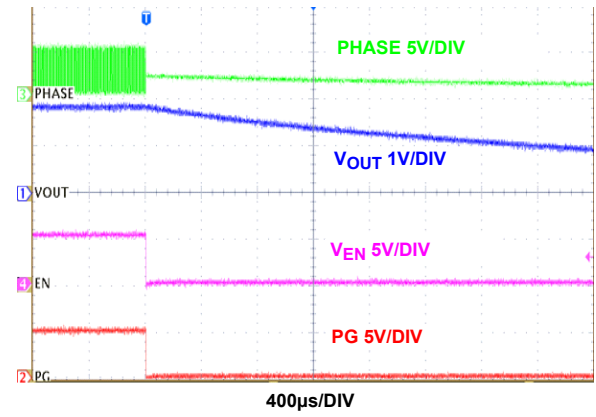

FIGURE 17. SHUTDOWN AT NO LOAD (PWM)

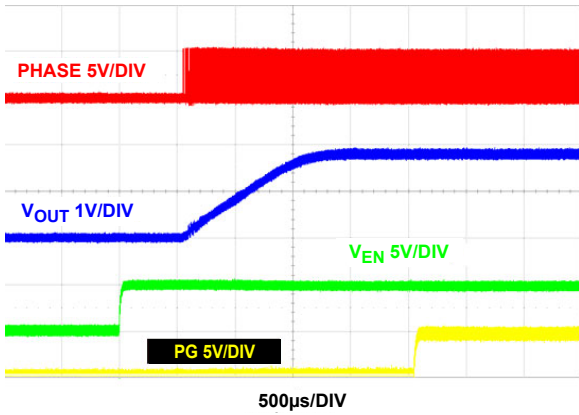

FIGURE 18. START-UP AT 4A LOAD (PWM)

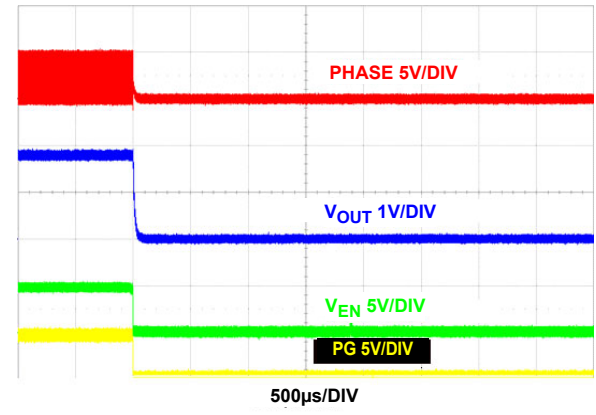

FIGURE 19. SHUTDOWN AT 4A LOAD (PWM)

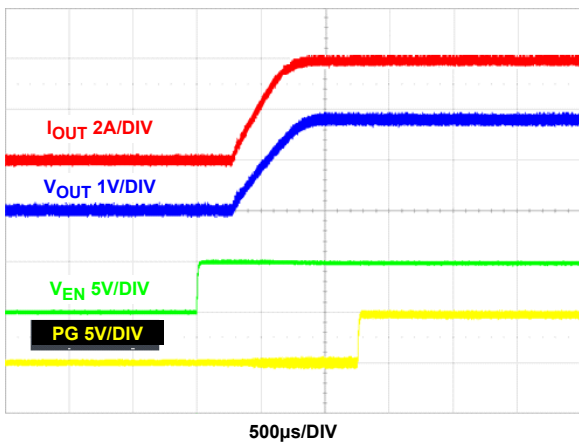

FIGURE 20. START-UP AT 4A LOAD (PFM)

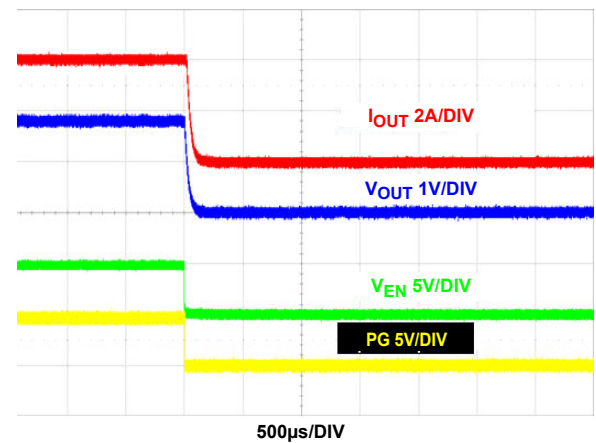

FIGURE 21. SHUTDOWN AT 4A LOAD (PFM)

Typical Operating Performance

Unless otherwise noted, operating conditions are: $T_A = +25^\circ\text{C}$, $V_{IN} = 5\text{V}$, $EN = V_{IN}$, $SYNC = V_{IN}$, $L = 1.0\mu\text{H}$, $C_1 = 22\mu\text{F}$, $C_2 = 2 \times 22\mu\text{F}$, $I_{OUT} = 0\text{A to } 4\text{A}$. (Continued)

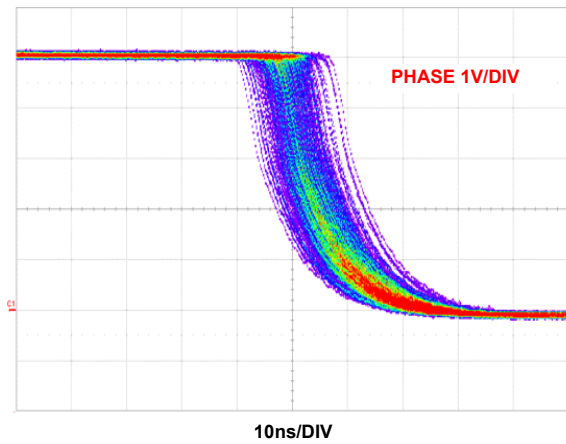

FIGURE 22. JITTER AT NO LOAD PWM (1MHz)

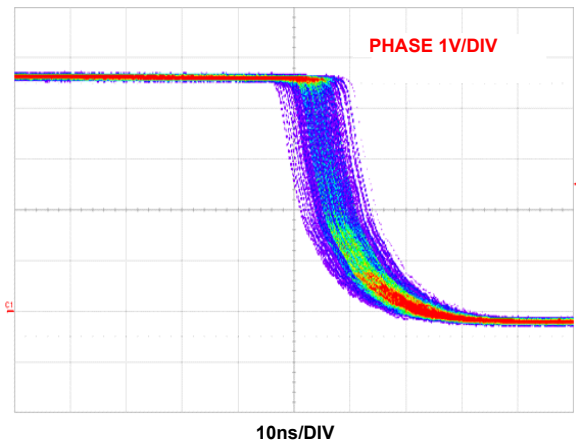

FIGURE 23. JITTER AT FULL LOAD PWM (1MHz)

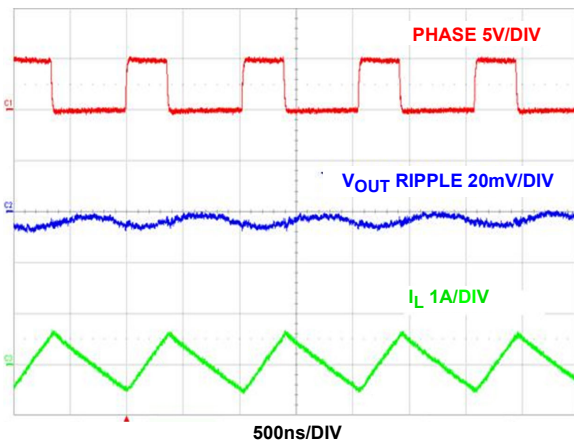

FIGURE 24. STEADY STATE AT NO LOAD PWM

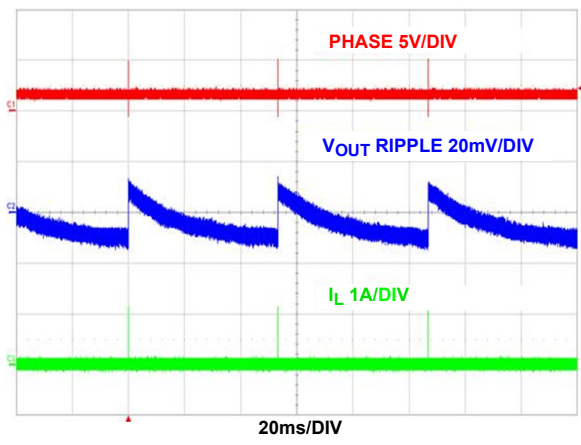

FIGURE 25. STEADY STATE AT NO LOAD PFM

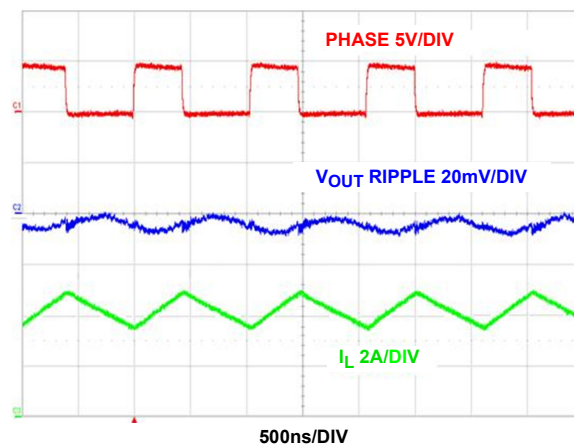

FIGURE 26. STEADY STATE AT 4A PWM

Typical Operating Performance

Unless otherwise noted, operating conditions are: $T_A = +25^\circ\text{C}$, $V_{IN} = 5\text{V}$, $EN = V_{IN}$,

$\text{SYNC} = V_{IN}$, $L = 1.0\mu\text{H}$, $C_1 = 22\mu\text{F}$, $C_2 = 2 \times 22\mu\text{F}$, $I_{OUT} = 0\text{A to } 4\text{A}$. (Continued)

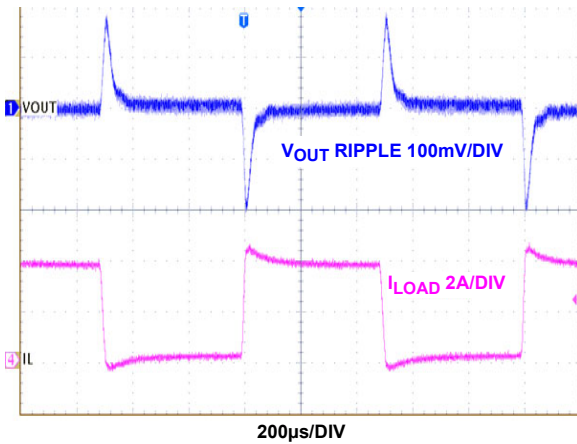

FIGURE 27. LOAD TRANSIENTS (PWM)

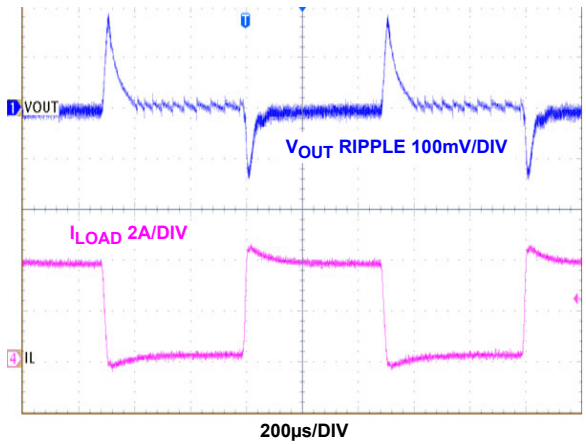

FIGURE 28. LOAD TRANSIENTS (PFM)

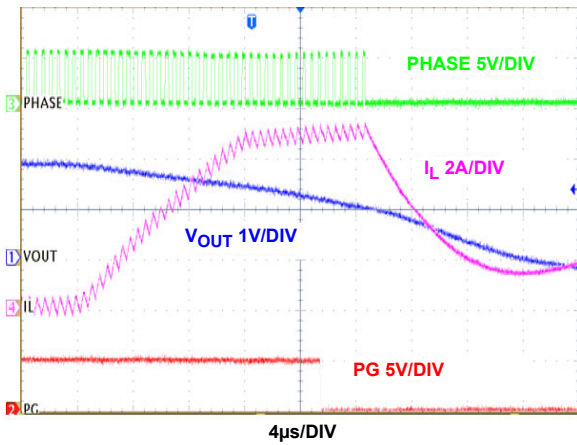

FIGURE 29. OUTPUT SHORT-CIRCUIT

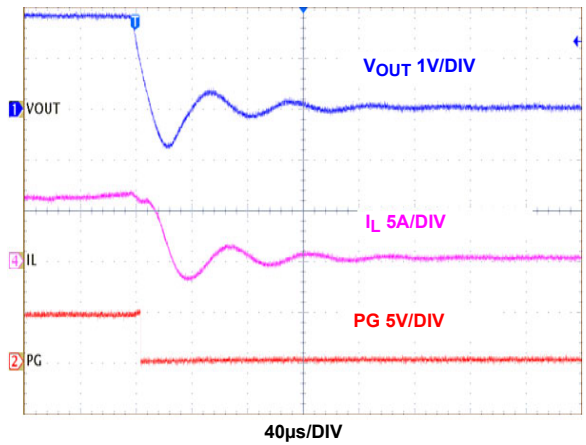

FIGURE 30. OVERCURRENT PROTECTION

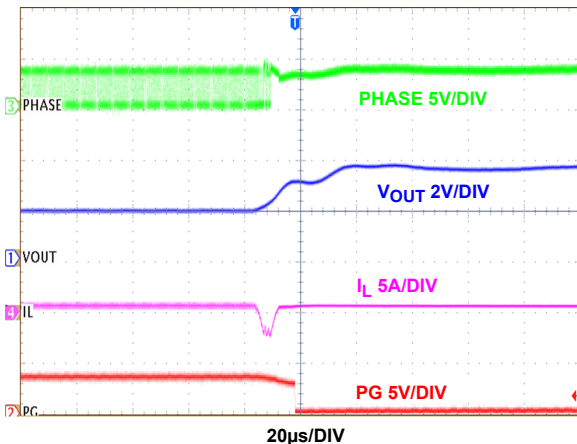

FIGURE 31. OVERVOLTAGE PROTECTION

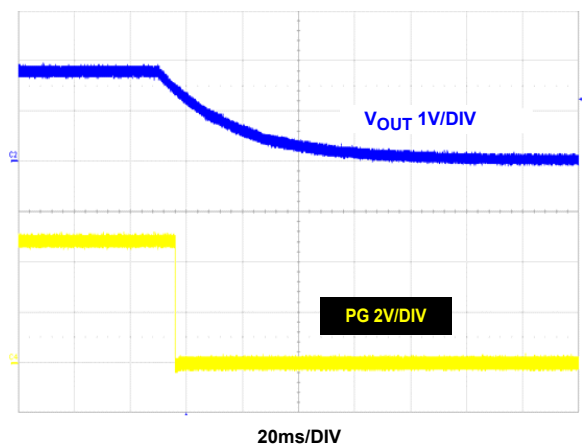

FIGURE 32. OVER-TEMPERATURE PROTECTION

Theory of Operation

The ISL78233 and ISL78234 are step-down switching regulators optimized for automotive battery powered applications. The regulator operates at a 2MHz default switching frequency for high efficiency and allow smaller form factor, when FS is connected to VIN. By connecting a resistor from FS to SGND, the operational frequency adjustable range is 500kHz to 4MHz. At light load, the regulator reduces the switching frequency, unless forced to the fixed frequency, to minimize the switching loss and to maximize the battery life. The quiescent current when the output is not loaded is typically only 45 μ A. The supply current is typically only 3.8 μ A when the regulator is shut down.

PWM Control Scheme

Pulling the SYNC pin HI (>0.8V) forces the converter into PWM mode, regardless of output current. The ISL78233 and ISL78234 employ the current-mode Pulse-Width Modulation (PWM) control scheme for fast transient response and pulse-by-pulse current limiting. [Figure 3 on page 4](#) shows the functional block diagram. The current loop consists of the oscillator, the PWM comparator, current-sensing circuit, and the slope compensation for the current loop stability. The slope compensation is 440mV/Ts, which changes proportionally with frequency. The gain for the current-sensing circuit is typically 200mV/A. The control reference for the current loops comes from the Error Amplifier's (EAMP) output.

The PWM operation is initialized by the clock from the oscillator. The P-channel MOSFET is turned on at the beginning of a PWM cycle and the current in the MOSFET starts to ramp up. When the sum of the current amplifier CSA and the slope compensation reaches the control reference of the current loop, the PWM comparator COMP sends a signal to the PWM logic to turn off the PFET and turn on the N-channel MOSFET. The NFET stays on until the end of the PWM cycle. [Figure 33](#) shows the typical operating waveforms during the PWM operation. The dotted lines illustrate the sum of the slope compensation ramp and the current-sense amplifier's CSA output.

The output voltage is regulated by controlling the V_{EAMP} voltage to the current loop. The bandgap circuit outputs a 0.6V reference voltage to the voltage loop. The feedback signal comes from the VFB pin. The soft-start block only affects the operation during the start-up and is discussed separately. The error amplifier is a transconductance amplifier that converts the voltage error signal to a current output. The voltage loop is internally compensated with the 55pF and 100k Ω RC network. The maximum EAMP voltage output is precisely clamped to 2.5V.

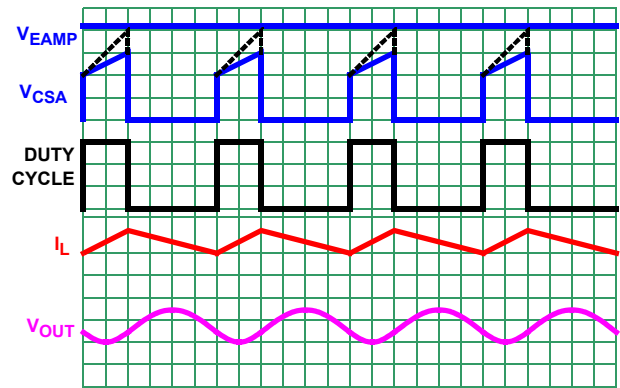

FIGURE 33. PWM OPERATION WAVEFORMS

Skip Mode

Pulling the SYNC pin LO (<0.4V) forces the converter into PFM mode. The ISL78233 and ISL78234 enter a Pulse-Skipping mode at light load to minimize the switching loss by reducing the switching frequency. [Figure 34 on page 15](#) illustrates Skip mode operation. A zero-cross sensing circuit shown in [Figure 3 on page 4](#) monitors the NFET current for zero crossing. When 16 consecutive cycles are detected, the regulator enters Skip mode. During the sixteen detecting cycles, the current in the inductor is allowed to become negative. The counter is reset to zero when the current in any cycle does not cross zero.

When Skip mode is entered, the pulse modulation starts being controlled by the Skip comparator shown in [Figure 3 on page 4](#). Each pulse cycle is still synchronized by the PWM clock. The PFET is turned on at the clock's rising edge and turned off when the output is higher than 1.2% of the nominal regulation or when its current reaches the peak Skip current limit value. Then, the inductor current is discharging to 0A and stays at zero (the internal clock is disabled), and the output voltage reduces gradually due to the load current discharging the output capacitor. When the output voltage drops to the nominal voltage, the PFET is turned on again at the rising edge of the internal clock as it repeats the previous operations.

The regulator resumes normal PWM mode operation when the output voltage drops 1.2% below the nominal voltage.

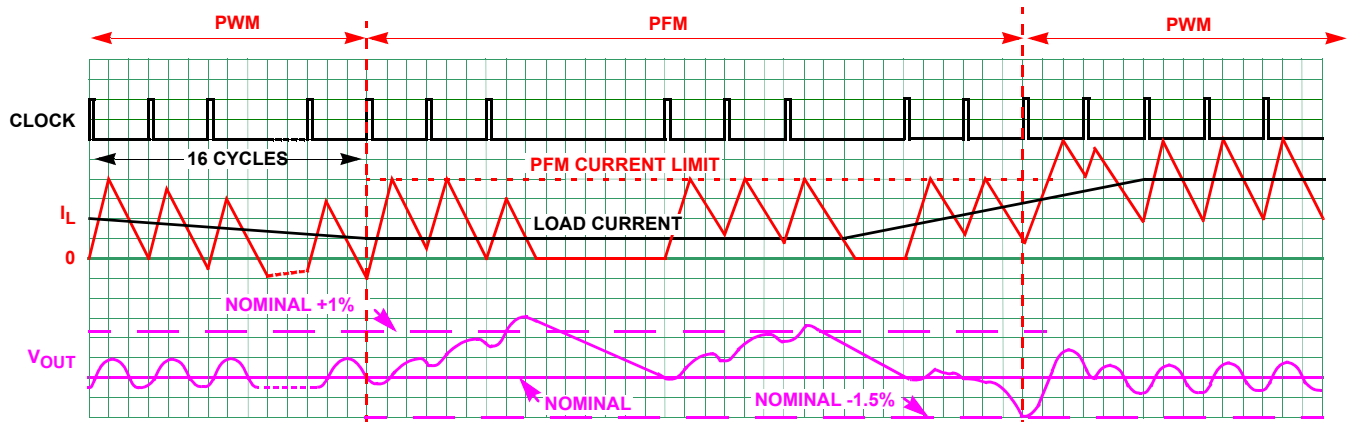

FIGURE 34. SKIP MODE OPERATION WAVEFORMS

Frequency Adjust

The frequency of operation is fixed at 2MHz when FS is tied to VIN. Adjustable frequency ranges from 500kHz to 4MHz using a simple resistor connecting FS to SGND according to [Equation 1](#):

$$R_{FS}[\text{k}\Omega] = \frac{220 \cdot 10^3}{f_{OSC}[\text{kHz}]} - 14 \quad (\text{EQ. 1})$$

The ISL78233 and ISL78234 have frequency synchronization capability by simply connecting the SYNC pin to an external square pulse waveform. The frequency synchronization feature synchronizes the positive edge trigger and its switching frequency up to 4MHz. The minimum external SYNC frequency is half of the free running frequency (either the default frequency or determined by the FS resistor).

Overcurrent Protection

The overcurrent protection is realized by monitoring the CSA output with the OCP comparator, as shown in [Figure 3 on page 4](#). The current sensing circuit has a gain of 200mV/A, from the P-FET current to the CSA output. When the CSA output reaches the threshold, the OCP comparator is tripled to turn off the PFET immediately. The overcurrent function protects the switching converter from a shorted output by monitoring the current flowing through the upper MOSFET.

If an overcurrent condition is detected, the upper MOSFET is immediately turned off and does not turn on again until the next switching cycle. When the initial overcurrent condition is detected, the overcurrent fault counter is set to 1. If, on the subsequent cycle, another overcurrent condition is detected, the OC fault counter is incremented. If there are 17 sequential OC fault detections, the regulator is shut down under an overcurrent fault condition. An overcurrent fault condition results in the regulator attempting to restart in a Hiccup mode within the delay of eight soft-start periods. At the end of the eighth soft-start wait period, the fault counters are reset and soft-start is attempted again. If the overcurrent condition goes away during the delay of eight soft-start periods, the output resumes back into regulation point after Hiccup mode expires.

Negative Current Protection

Similar to overcurrent, the negative current protection is realized by monitoring the current across the low-side NFET, as shown in [Figure 3 on page 4](#). When the valley point of the inductor current reaches -3A for four consecutive cycles, both PFET and NFET are off. The 100Ω in parallel to the NFET activates discharging the output into regulation. The control begins to switch when output is within regulation. The regulator is in PFM for 20μs before switching to PWM if necessary.

PG

PG is an open-drain output of a window comparator that continuously monitors the buck regulator output voltage. PG is actively held low when EN is low and during the buck regulator soft-start period. After a 1ms soft-start period delay, PG becomes high impedance as long as the output voltage is within nominal regulation voltage set by VFB. When VFB drops 15% below or raises 0.8V above the nominal regulation voltage, the ISL78233 and ISL78234 pull PG low. Any fault condition forces PG low until the fault condition is cleared by attempts to soft-start. For logic level output voltages, connect an external pull-up resistor, R₁, between PG and VIN. A 100kΩ resistor works well in most applications.

UVLO

When the input voltage is below the Undervoltage Lockout (UVLO) threshold, the regulator is disabled.

Soft Start-Up

The soft start-up reduces the inrush current during the start-up. The soft-start block outputs a ramp reference to the input of the error amplifier. This voltage ramp limits the inductor current and the output voltage speed, so that the output voltage rises in a controlled fashion. When VFB is less than 0.1V at the beginning of the soft-start, the switching frequency is reduced to 200kHz so that the output can start-up smoothly at light load condition. During soft-start, the IC operates in Skip mode to support prebiased output condition.

Tie SS to SGND for internal soft-start is approximately 1ms. Connect a capacitor from SS to SGND to adjust the soft-start time. This capacitor, along with an internal 2.1μA current source

sets the soft-start interval of the converter, t_{SS} as shown by [Equation 2](#).

$$C_{SS}[\mu\text{F}] = 3.1 \cdot t_{SS}[\text{s}] \quad (\text{EQ. 2})$$

C_{SS} must be less than 33nF to insure proper soft-start reset after fault condition.

Enable

The Enable (EN) input allows you to control the turning on or off of the regulator for purposes such as power-up sequencing.

When the regulator is enabled, there is typically a 600 μ s delay for waking up the bandgap reference and then the soft start-up begins. EN should be held below the EN_VIL until V_{IN} exceeds V_{UVLO} rising.

Discharge Mode (Soft-Stop)

When a transition to shutdown mode occurs or the V_{IN} UVLO is set, the outputs discharge to GND through an internal 100 Ω switch.

Power MOSFETs

The power MOSFETs are optimized for best efficiency. The ON-resistance for the PFET is typically 35m Ω and the ON-resistance for the NFET is typically 11m Ω .

100% Duty Cycle

The ISL78233 and ISL78234 feature 100% duty cycle operation to maximize the battery life. When the battery voltage drops to a level that the ISL78233 and ISL78234 can no longer maintain the regulation at the output, the regulator completely turns on the P-FET. The maximum dropout voltage under the 100% duty-cycle operation is the product of the load current and the ON-resistance of the PFET.

Thermal Shutdown

The ISL78233 and ISL78234 have built-in thermal protection. When the internal temperature reaches +150 $^{\circ}$ C, the regulator is completely shut down. As the temperature drops to +125 $^{\circ}$ C, the ISL78233 and ISL78234 resume operation by stepping through the soft-start.

Applications Information

Output Inductor and Capacitor Selection

To consider steady state and transient operations, the ISL78233 and ISL78234 typically use a 1.0 μ H output inductor. The higher or lower inductor value can be used to optimize the total converter system performance. For example, for higher output voltage 3.3V application, in order to decrease the inductor current ripple and output voltage ripple, the output inductor value can be increased. Renesas recommends setting the ripple inductor current to approximately 30% of the maximum output current for optimized performance. The inductor ripple current can be expressed as shown in [Equation 3](#):

$$\Delta I = \frac{V_O \cdot \left(1 - \frac{V_O}{V_{IN}}\right)}{L \cdot f_S} \quad (\text{EQ. 3})$$

The inductor's saturation current rating needs to be at least larger than the peak current. The ISL78233 and ISL78234 protect the typical peak current 4.9A/6.7A. The saturation current needs to be over 7A for maximum output current application.

The ISL78233 and ISL78234 use an internal compensation network and the output capacitor value is dependent on the output voltage. The recommended ceramic capacitor is X5R or X7R. The recommended X5R or X7R minimum output capacitor values are shown in [Table 1 on page 3](#).

In [Table 1](#), the minimum output capacitor value is given for the different output voltages to make sure that the whole converter system is stable. Additional output capacitance should be added for better performance in applications where high load transient or low output ripple is required. Renesas recommends checking the system level performance along with the simulation model.

Output Voltage Selection

The output voltage of the regulator can be programmed using an external resistor divider that scales the output voltage relative to the internal reference voltage, and feeds it back to the inverting input of the error amplifier (see [Figure 2 on page 3](#)).

The output voltage programming resistor, R_2 , depends on the value chosen for the feedback resistor and the desired output voltage of the regulator. The value for the feedback resistor, R_3 , is typically between 10k Ω and 100k Ω , as shown in [Equation 4](#).

$$R_2 = R_3 \left(\frac{V_O}{V_{FB}} - 1 \right) \quad (\text{EQ. 4})$$

If the output voltage desired is 0.6V, then R_3 is left unpopulated and R_2 is shorted. There is a leakage current from VIN to PHASE. Renesas recommends preloading the output with 10 μ A minimum. For better performance, add 15pF in parallel with R_2 (200k Ω). Check loop analysis before use in application.

Input Capacitor Selection

The main functions for the input capacitor are providing decoupling of the parasitic inductance and a filtering function to prevent the switching current flowing back to the battery rail. At least two 22 μ F X5R or X7R ceramic capacitors are a good starting point for the input capacitor selection.

Loop Compensation Design

When COMP is not connected to VDD, the COMP pin is active for external loop compensation. The ISL78233 and ISL78234 use constant frequency peak current mode control architecture to achieve a fast loop transient response. An accurate current-sensing pilot device in parallel with the upper MOSFET is used for peak current control signal and overcurrent protection. The inductor is not considered as a state variable because its peak current is constant, and the system becomes a single order system. It is much easier to design a type II compensator to stabilize the loop than to implement voltage mode control. Peak current mode control has an inherent input voltage feed-forward function to achieve good line regulation. [Figure 35 on page 17](#) shows the small signal model of the synchronous buck regulator.

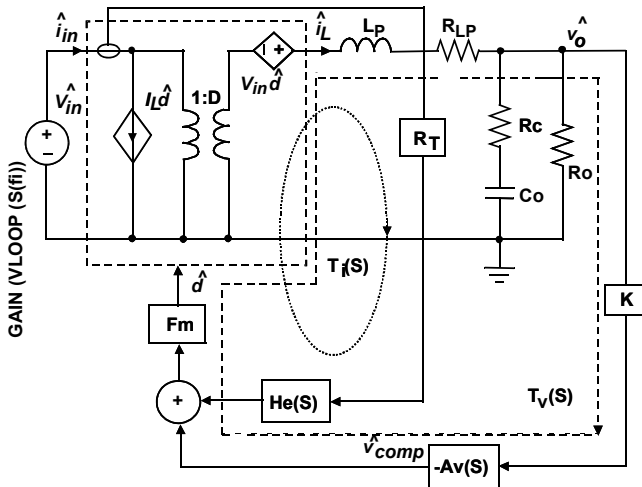

FIGURE 35. SMALL SIGNAL MODEL OF SYNCHRONOUS BUCK REGULATOR

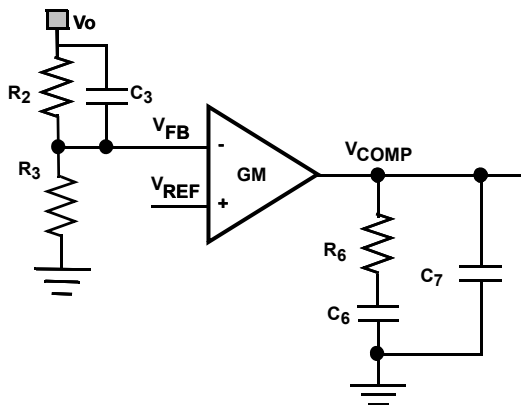

FIGURE 36. TYPE II COMPENSATOR

Figure 36 shows the type II compensator and its transfer function is expressed as Equation 5:

$$A_v(s) = \frac{\hat{v}_{comp}}{V_{FB}} = \frac{GM \cdot R_3}{(C_6 + C_7) \cdot (R_2 + R_3)} \frac{\left(1 + \frac{s}{\omega_{cz1}}\right) \left(1 + \frac{s}{\omega_{cz2}}\right)}{s \left(1 + \frac{s}{\omega_{cp1}}\right) \left(1 + \frac{s}{\omega_{cp2}}\right)} \quad (EQ. 5)$$

where,

$$\omega_{cz1} = \frac{1}{R_6 C_6}, \quad \omega_{cz2} = \frac{1}{R_2 C_3}, \quad \omega_{cp1} = \frac{C_6 + C_7}{R_6 C_6 C_7}, \quad \omega_{cp2} = \frac{R_2 + R_3}{C_3 R_2 R_3}$$

Compensator design goal:

- High DC gain
- Choose loop bandwidth f_c less than 100kHz
- Gain margin: >10dB
- Phase margin: >40°

The compensator design procedure is as follows:

The loop gain at crossover frequency of f_c has a unity gain. Therefore, the compensator resistance R_6 is determined by Equation 6.

$$R_6 = \frac{2\pi f_c V_o C_o R_t}{GM \cdot V_{FB}} = 17.45 \times 10^3 \cdot f_c V_o C_o \quad (EQ. 6)$$

where GM is the sum of the transconductance, g_m , of the voltage error amplifier in each phase. Compensator capacitor C_6 is then given by Equation 7.

$$C_6 = \frac{R_o C_o}{R_6} = \frac{V_o C_o}{I_o R_6}, C_7 = \max\left(\frac{R_c C_o}{R_6}, \frac{1}{\pi f_s R_6}\right) \quad (EQ. 7)$$

Place one compensator pole at zero frequency to achieve high DC gain, and put another compensator pole at either ESR zero frequency or half switching frequency, whichever is lower in Equation 7. An optional zero can boost the phase margin. ω_{cz2} is a zero due to R_2 and C_3 .

Place compensator zero 2 to 5 times f_c :

$$C_3 = \frac{1}{\pi f_c R_2} \quad (EQ. 8)$$

Example: $V_{IN} = 5V$, $V_O = 1.8V$, $I_O = 4A$, $FS = 1MHz$, $R_2 = 200k\Omega$, $R_3 = 100k\Omega$, $C_o = 2 \times 22\mu F / 3m\Omega$, $L = 1\mu H$, $f_c = 100kHz$, then compensator resistance R_6 :

$$R_6 = 17.45 \times 10^3 \cdot 100kHz \cdot 1.8V \cdot 44\mu F = 138k\Omega \quad (EQ. 9)$$

It is acceptable to use 137kΩ as the closest standard value for R_6 .

$$C_6 = \frac{1.8V \cdot 44\mu F}{4A \cdot 137k\Omega} = 144pF \quad (EQ. 10)$$

$$C_7 = \max\left(\frac{3m\Omega \cdot 44\mu F}{137k\Omega}, \frac{1}{\pi \cdot 1MHz(137k\Omega)}\right) = (1pF, 2.3pF) \quad (EQ. 11)$$

It is also acceptable to use the closest standard values for C_6 and C_7 . There is approximately 3pF parasitic capacitance from V_{COMP} to GND; Therefore, C_7 is optional. Use $C_6 = 150pF$ and $C_7 = OPEN$.

$$C_3 = \frac{1}{\pi 100kHz \cdot 200k\Omega} = 16pF \quad (EQ. 12)$$

Use $C_3 = 15pF$. Note that C_3 may increase the loop bandwidth from previous estimated value. Figure 37 on page 18 shows the simulated voltage loop gain. It is shown that it has a 150kHz loop bandwidth with a 42° phase margin and 10dB gain margin. It may be more desirable to achieve an increased phase margin. This can be accomplished by lowering R_6 by 20% to 30%.

PCB Layout Recommendation

The PCB layout is a very important converter design step to make sure the designed converter works well. For the ISL78233 and ISL78234, the power loop is composed of the output inductor L's, the output capacitor C_O, the PHASE pins, and the PGND pin. It is necessary to make the power loop as small as possible and the connecting traces among them should be direct, short, and wide. The switching node of the converter, the PHASE pins and the traces connected to the node are very noisy, so keep the voltage feedback trace away from these noisy traces. Place the input capacitor as close as possible to the VIN pin. Connect the ground of the input and output capacitors as close as possible. The heat of the IC is mainly dissipated through the thermal pad.

Maximizing the copper area connected to the thermal pad is preferable. In addition, a solid ground plane is helpful for better EMI performance. See [TB389](#) for via placement on the copper area of the PCB underneath the thermal pad for optimum thermal performance.

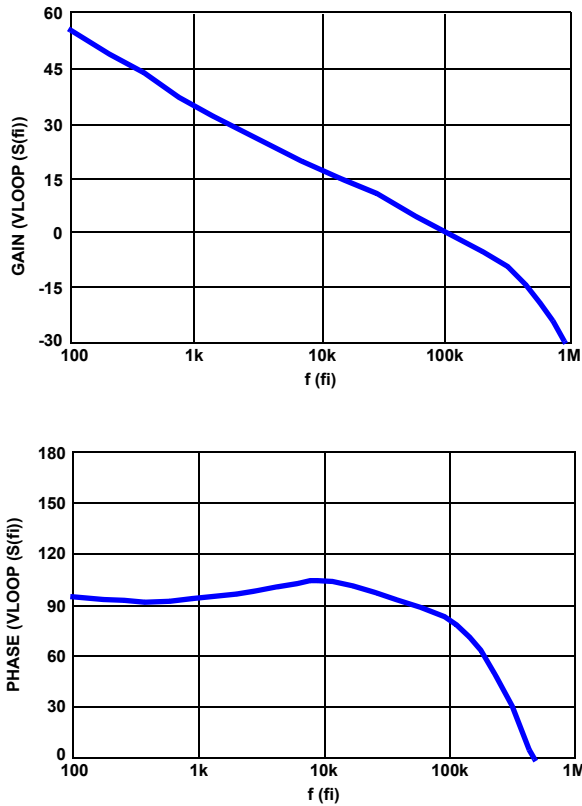

FIGURE 37. SIMULATED LOOP GAIN

Revision History

The revision history provided is for informational purposes only and is believed to be accurate, but not warranted. Please go to web to make sure you have the latest revision.

DATE	REVISION	CHANGE
Jan 20, 2022	11.00	Removed Related Literature section. Updated the Ordering Information table formatting. Updated POD L16.5x5D to the latest revision, changes are as follows: -Added Edge protection Technology -Change dimension top view inner dimension 4.75 to 4.71mm -Bottom View: For C_C, moved the horizontal line to the top of the dimple.
Jan 12, 2021	10.00	Added ISL78233BARZ, ISL78233BARZ-T, and ISL78233BARZ-T7A to Ordering Information.
Feb 21, 2019	9.00	Updated PHASE Absolute Maximum Ratings information. Added Notes 7 and 8. Updated links throughout document. Updated disclaimer.
Apr 19, 2018	8.00	Updated Related Literature section. Updated Ordering Information table by adding tape and reel information, Note 3, and updating Note 1. Adding Note 8 and its cross-referencing on page 7. Added symbol name "EN_VIL" to the Logic Input Low parameter and the symbol name "EN_VIH" to the Logic Input High parameter on page 7. Updated Enable section on page 14. Removed About Intersil section and updated disclaimer.
Dec 4, 2015	7.00	Added a new User Guide to Related Literature section. Added EVAL2 part numbers to the ordering information table. Added Table 2 on page 5.
Nov 10, 2015	6.00	Added 5x5mmWFQFN information throughout datasheet. Updated Note 1 on page 5 from "Add "-T*" suffix for tape and reel." to "Add "-T" suffix for 6k unit or "-T7A" suffix for 250 unit tape and reel options." In "PWM Control Scheme" on page 14 (last sentence) corrected a typo by changing "1.6V to "2.5V". Table 1 on page 3: Updated L1 row. Updated the "PCB Layout Recommendation" section on page 18. Added POD L16.5x5D.
Apr 23, 2015	5.00	Updated the 4th Features bullet page 1 by changing value from "0.8%" to "-1.2%/1%".
Apr 23, 2014	4.00	Updated electrical table, changed Phase minimum on-time MAX from 133ns to 100ns on page 8 Updated electrical table, modified test conditions for Error Amplifier trans-conductance and Power-good Output Low Voltage on page 8 Removed references to VOUT = 0.8V, and 0.9V Added typical curve for Phase minimum on-time vs VIN on page 10 Added description on synchronized control on page 15
Feb 24, 2014	3.00	Updated ESD rating qual references from Jedec standard references to AEC-Q100 standard references on page 7
Dec 13, 2013	2.00	Last Features bullet on page 1: changed from "Qualified for automotive application" to "AEC-Q100 qualified"
Oct 16, 2013	1.00	Initial Release.

Package Outline Drawings

For the most recent package outline drawing, see [L16.3x3D](#).

L16.3x3D

16 Lead Thin Quad Flat No-Lead Plastic Package

Rev 0, 3/10

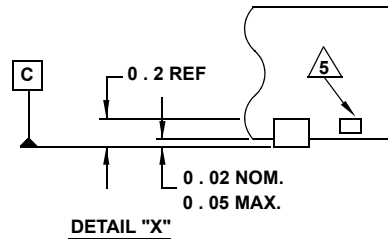
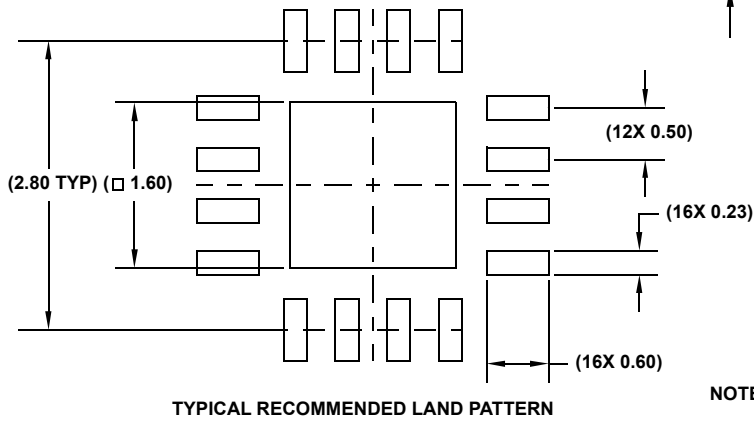
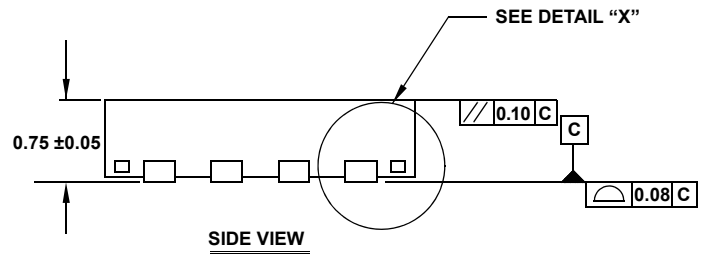
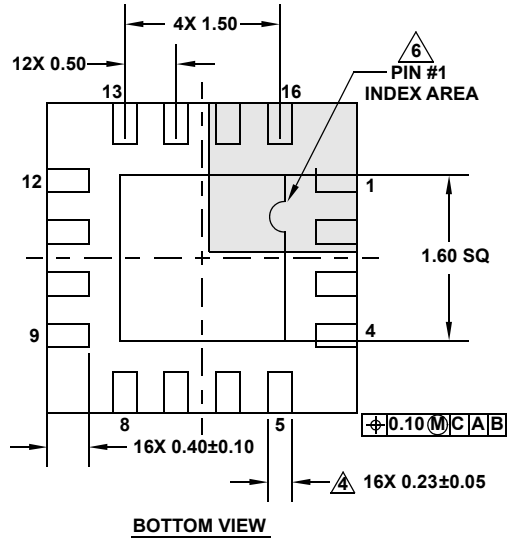
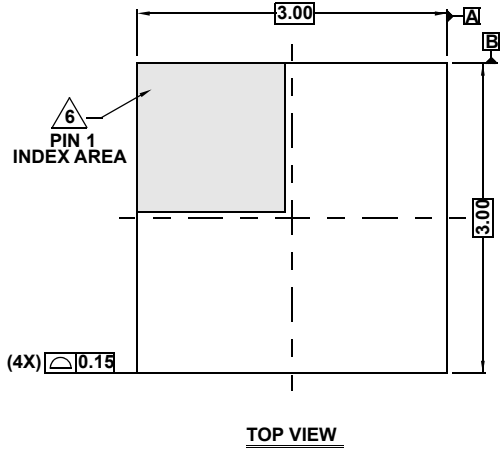

NOTES:

1. Dimensions are in millimeters.
Dimensions in () for Reference Only.
2. Dimensioning and tolerancing conform to ASME Y14.5m-1994.
3. Unless otherwise specified, tolerance : Decimal ± 0.05
4. Dimension applies to the metallized terminal and is measured between 0.15mm and 0.25mm from the terminal tip.
5. Tiebar shown (if present) is a non-functional feature.
6. The configuration of the pin #1 identifier is optional, but must be located within the zone indicated. The pin #1 identifier may be either a mold or mark feature.
7. JEDEC reference drawing: MO-220 WEED.

For the most recent package outline drawing, see [L16.5x5D](#).

L16.5x5D
16 Lead Quad Flat No-Lead Plastic Package (Punch QFN with Wettable Flank)
 Rev 3, 11/2021

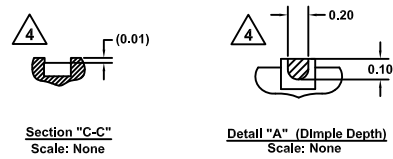
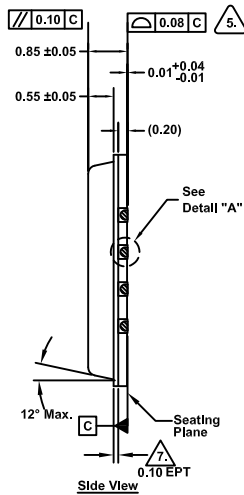
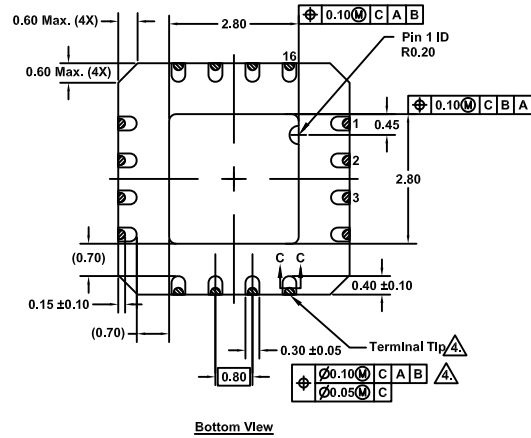
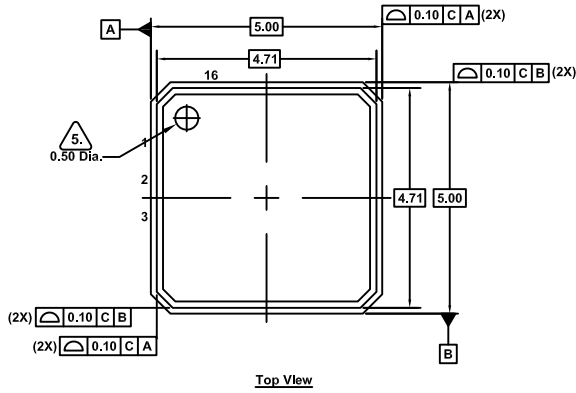

Notes:

1. Dimensions are in millimeters. Dimensions in () for Reference Only.
2. Dimensioning and tolerancing conform to ASME Y14.5m-1994.
3. Unless otherwise specified, tolerance : Decimal ±0.05
4. Dimension applies to the plated terminal and is measured between 0.15mm and 0.30mm from the terminal tip.
5. The configuration of the pin #1 identifier is optional, but must be located within the zone indicated. The pin #1 identifier can be either a mold or mark feature.
6. Reference document: JEDEC MO220.
7. Edge Protection Technology.

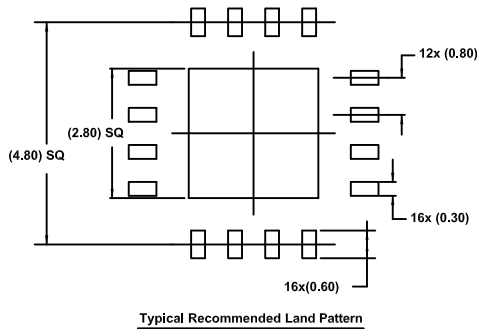

Notice

1. Descriptions of circuits, software and other related information in this document are provided only to illustrate the operation of semiconductor products and application examples. You are fully responsible for the incorporation or any other use of the circuits, software, and information in the design of your product or system. Renesas Electronics disclaims any and all liability for any losses and damages incurred by you or third parties arising from the use of these circuits, software, or information.
2. Renesas Electronics hereby expressly disclaims any warranties against and liability for infringement or any other claims involving patents, copyrights, or other intellectual property rights of third parties, by or arising from the use of Renesas Electronics products or technical information described in this document, including but not limited to, the product data, drawings, charts, programs, algorithms, and application examples.
3. No license, express, implied or otherwise, is granted hereby under any patents, copyrights or other intellectual property rights of Renesas Electronics or others.
4. You shall be responsible for determining what licenses are required from any third parties, and obtaining such licenses for the lawful import, export, manufacture, sales, utilization, distribution or other disposal of any products incorporating Renesas Electronics products, if required.
5. You shall not alter, modify, copy, or reverse engineer any Renesas Electronics product, whether in whole or in part. Renesas Electronics disclaims any and all liability for any losses or damages incurred by you or third parties arising from such alteration, modification, copying or reverse engineering.
6. Renesas Electronics products are classified according to the following two quality grades: "Standard" and "High Quality". The intended applications for each Renesas Electronics product depends on the product's quality grade, as indicated below.

"Standard": Computers; office equipment; communications equipment; test and measurement equipment; audio and visual equipment; home electronic appliances; machine tools; personal electronic equipment; industrial robots; etc.

"High Quality": Transportation equipment (automobiles, trains, ships, etc.); traffic control (traffic lights); large-scale communication equipment; key financial terminal systems; safety control equipment; etc.

Unless expressly designated as a high reliability product or a product for harsh environments in a Renesas Electronics data sheet or other Renesas Electronics document, Renesas Electronics products are not intended or authorized for use in products or systems that may pose a direct threat to human life or bodily injury (artificial life support devices or systems; surgical implantations; etc.), or may cause serious property damage (space system; undersea repeaters; nuclear power control systems; aircraft control systems; key plant systems; military equipment; etc.). Renesas Electronics disclaims any and all liability for any damages or losses incurred by you or any third parties arising from the use of any Renesas Electronics product that is inconsistent with any Renesas Electronics data sheet, user's manual or other Renesas Electronics document.

7. No semiconductor product is absolutely secure. Notwithstanding any security measures or features that may be implemented in Renesas Electronics hardware or software products, Renesas Electronics shall have absolutely no liability arising out of any vulnerability or security breach, including but not limited to any unauthorized access to or use of a Renesas Electronics product or a system that uses a Renesas Electronics product. RENESAS ELECTRONICS DOES NOT WARRANT OR GUARANTEE THAT RENESAS ELECTRONICS PRODUCTS, OR ANY SYSTEMS CREATED USING RENESAS ELECTRONICS PRODUCTS WILL BE INVULNERABLE OR FREE FROM CORRUPTION, ATTACK, VIRUSES, INTERFERENCE, HACKING, DATA LOSS OR THEFT, OR OTHER SECURITY INTRUSION ("Vulnerability Issues"). RENESAS ELECTRONICS DISCLAIMS ANY AND ALL RESPONSIBILITY OR LIABILITY ARISING FROM OR RELATED TO ANY VULNERABILITY ISSUES. FURTHERMORE, TO THE EXTENT PERMITTED BY APPLICABLE LAW, RENESAS ELECTRONICS DISCLAIMS ANY AND ALL WARRANTIES, EXPRESS OR IMPLIED, WITH RESPECT TO THIS DOCUMENT AND ANY RELATED OR ACCOMPANYING SOFTWARE OR HARDWARE, INCLUDING BUT NOT LIMITED TO THE IMPLIED WARRANTIES OF MERCHANTABILITY, OR FITNESS FOR A PARTICULAR PURPOSE.
8. When using Renesas Electronics products, refer to the latest product information (data sheets, user's manuals, application notes, "General Notes for Handling and Using Semiconductor Devices" in the reliability handbook, etc.), and ensure that usage conditions are within the ranges specified by Renesas Electronics with respect to maximum ratings, operating power supply voltage range, heat dissipation characteristics, installation, etc. Renesas Electronics disclaims any and all liability for any malfunctions, failure or accident arising out of the use of Renesas Electronics products outside of such specified ranges.