

ISL7823xEVAL2Z

Evaluation Board User Guide

UG062
Rev 0.00
April 8, 2016

Description

The ISL78233EVAL2Z, ISL78234EVAL2Z and ISL78235EVAL2Z evaluation boards are used to demonstrate the performance of the [ISL78233](#), [ISL78234](#) and [ISL78235](#) low quiescent current, high efficiency synchronous buck regulators. The evaluation boards are intended for use by customers with requirements for point-of-load automotive applications with 2.7V to 5.5V input supply voltage, output voltages down to 0.8V and up to a 5A output current.

The ISL78233, ISL78234 and ISL78235 are offered in a 5x5mm 16 Ld Wettable Flank QFN (WFQFN) package with 0.9mm maximum height.

Specifications

PART NUMBER	I _{OUT} (MAX) (A)	f _{SW} RANGE (MHz)	V _{IN} RANGE (V)	V _{OUT} RANGE (V)	PART SIZE (mm)
ISL78235	5	Programmable 1MHz to 4MHz	2.7 to 5.5	0.8 to 5.5	5x5
ISL78234	4				
ISL78233	3				

PCB SPECIFICATION

Board Dimension: 2.025inx2.725in
of Layers: 4
FR-4 Thickness: 1.57mm
Copper Weight: 2oz.

NOTES:

- The evaluation board default V_{OUT} = 1.8V.
- The evaluation board default f_{SW} = 2MHz.

Key Features

- 2.7V to 5.5V input voltage range
- Synchronous buck regulator up to 95% efficiency
- 1% reference accuracy over temperature
- Resistor adjustable frequency from 500kHz to 4MHz; Default set to 2MHz
- External synchronization from 1MHz to 4MHz
- 100ns maximum phase minimum on time allows wide output regulation operating at 2MHz
- Internal soft-start set to 1ms; adjustable with external soft-start capacitor
- Over-temperature, overcurrent, overvoltage and negative overcurrent protection

References

- [ISL78235](#) Datasheet
- [ISL78233, ISL78234](#) Datasheet

Ordering Information

PART NUMBER	DESCRIPTION
ISL78235EVAL2Z	Evaluation Board for 5A Synchronous Buck ISL78235
ISL78234EVAL2Z	Evaluation Board for 4A Synchronous Buck ISL78234
ISL78233EVAL2Z	Evaluation Board for 3A Synchronous Buck ISL78233

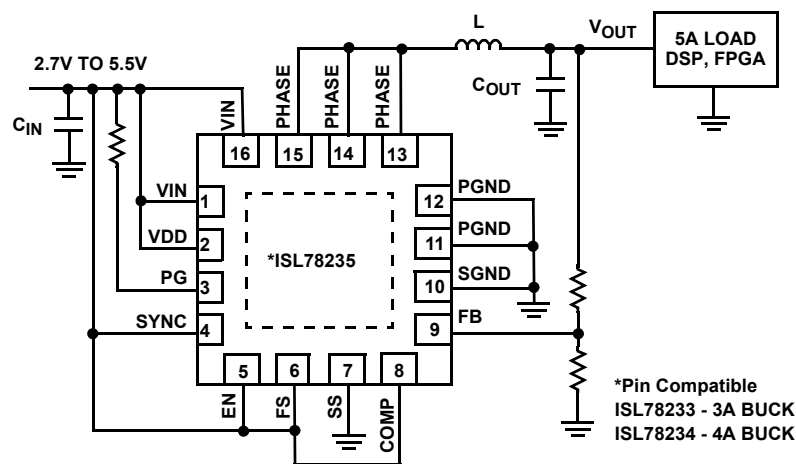

FIGURE 1. ISL7823xEVAL2Z BLOCK DIAGRAM

Recommended Equipment

The following equipment is recommended to perform testing:

- 0V to 5V power supply with 10A source current capability
- Electronic load capable of sinking current up to 10A
- Digital Multimeters (DMMs)
- 500MHz quad-trace oscilloscope
- Signal generator for EN and/or SYNC pins

Quick Setup Guide

1. Ensure that the circuit is correctly connected to the supply and loads prior to applying any power.
2. Connect the bias supply to VIN, the plus terminal to VIN (P4) and the negative return to PGND (P5).
3. Connect the output load to VOUT, the plus terminal to VOUT (P3) and the negative return to PGND (P7).
4. Verify that SW2 is in the proper position for PFM or PWM.
5. Verify that the position is ON for SW1.
6. Turn on the power supply and set for 2.7V to 5.0V.
7. Verify the output voltage is 1.8V for V_{OUT}.

Functional Description

The ISL78233EVAL2Z, ISL78234EVAL2Z and ISL78235EVAL2Z evaluation boards are used to demonstrate the performance of the ISL78233, ISL78234 and ISL78235 low quiescent current, high efficiency synchronous buck regulators. The evaluation boards are intended for use by customers with requirements for point-of-load automotive applications with 2.7V to 5.5V input supply voltage, output voltages down to 0.8V and up to a 5A output current. The ISL78233, ISL78234 and ISL78235 are offered in a 5x5mm 16 Ld Wettable Flank QFN (WFQFN) package with 0.9mm maximum height.

The schematics for the evaluation boards are shown in [Figure 4 on page 5](#). The evaluation boards include all components to easily evaluate the performance of the buck regulator. Hardware included on the evaluation boards allows the user to operate the following functions: Toggle switch for Enable/Disable, Toggle switch for PFM/forced PWM operation and test points for monitoring the switching node and output voltage.

Operating Voltage Range

The ISL78233EVAL2Z, ISL78234EVAL2Z and ISL78235EVAL2Z evaluation boards are designed to operate with 2.7V to 5.5V V_{IN} and the outputs are preset to 1.8V for V_{OUT}. The output voltage can be adjusted from 0.8V to 3.3V. The output voltage programming resistor, R₂, depends on the desired output voltage of the regulator. It is recommended to have R₃ set to 100kΩ. The value for R₂ is typically between 66kΩ and 450kΩ and is determined in [Equation 1](#).

$$R_2 = R_3 \cdot (V_O / V_{FB} - 1) \quad (\text{EQ. 1})$$

For faster transient response performance, add 10pF to 22pF in parallel to R₂. Check loop compensation analysis to insure optimum performance before use of capacitance.

Frequency Control

The ISL78233, ISL78234 and ISL78235 have an FS pin that controls the frequency of operation. Programmable frequency allows for optimization between efficiency and external component size. Default switching frequency is 2MHz when FS is tied to VIN (R₆ = 0). By removing R₆ and changing the value of R₄, the switching frequency can be changed from 500kHz to 4MHz according to [Equation 2](#):

$$R_4[\text{k}\Omega] = \frac{220 \cdot 10^3}{f_{\text{OSC}}[\text{kHz}]} - 14 \quad (\text{EQ. 2})$$

Please refer to the [ISL78235](#), [ISL78233](#), [ISL78234](#) datasheets for more details.

Soft-Start Control

The ISL78233, ISL78234 and ISL78235 have an SS pin that controls the soft start-up time. Short the SS pin to SGND for internal soft-start (approximately 1ms). Populate a capacitor at C₆ to adjust the soft-start time. This capacitor, along with an internal 2.1μA current source sets the soft-start interval of the converter, t_{SS}.

$$C_6[\mu\text{F}] = 3.5 \cdot t_{\text{SS}}[\text{s}] \quad (\text{EQ. 3})$$

C₆ should be less than 33nF to insure proper soft-start reset after a fault condition. The ISL78233EVAL2Z, ISL78234EVAL2Z and ISL78235EVAL2Z have a default 33nF on the board for a ~10ms soft-start time.

Control Switches for EN and SYNC

The evaluation boards contain switches SW1 and SW2 for control of the EN and SYNC pin. [Table 1](#) details this function.

TABLE 1. SWITCH SETTINGS

SW1	ENABLE	FUNCTION
1 (LEFT)	OFF	Disable IC
3 (RIGHT)	ON	Enable IC
SW2	SYNC	FUNCTION
1 (LEFT)	PFM	Skip mode at light load
3 (RIGHT)	PWM	Fixed PWM frequency at light load

Power Inductor

The evaluation boards contain a 0.68μH output power inductor. It has a 13.5A saturation current that is able to handle the peak current limit of the IC. The inductor is chosen to optimize performance for V_{IN} = 5V, V_{OUT} = 1.8V at 2MHz switching frequency for up to 5A output currents.



FIGURE 2. ISL78235EVAL2Z TOP SIDE



FIGURE 3. ISL78235EVAL2Z BOTTOM SIDE

Internal vs External Compensation

The ISL78233, ISL78234 and ISL78235 feature an internal compensation network on the output of the error amplifier. The internal compensation simplifies design by reducing external components while stabilizing the regulator under transient load response. To use an internal compensation network, tie the COMP pin to VDD.

The restriction of an internal compensation network is that it does not provide flexibility to optimize the compensation network for conditions when additional output capacitance is needed to minimize output overshoot from fast transient loading. The added capacitance affects the stability and response of the feedback loop. The internal compensation network is well suited for a wide range of switching frequencies and load di/dt transients, however, if the feedback network needs to be better optimized for the application, external compensation should be used. When the COMP pin is not connected to VDD, an RC network from the COMP pin to GND is used to provide the external compensation.

For more information on the specification of the internal compensation network and designing for stability, refer to the [ISL78235](#), [ISL78233](#), [ISL78234](#) datasheets for more details.

PCB Layout Recommendation

The PCB layout is a very important converter design step to make sure the designed converter works well. For ISL78233, ISL78234 and ISL78235, the power loop is composed of the output inductor L_o , the output capacitor (C_{OUT}), the PHASE pins and the PGND pins. It is necessary to make the power loop as small as possible and the connecting traces among them should be direct, short and wide. The switching node of the converter (PHASE pins) and the traces connected to the node are noisy. Keep the voltage feedback trace away from these noisy traces. The input capacitor should be placed as close as possible to the VIN/VDD and GND pin. The ground of input and output capacitors should be connected as close as possible. The heat of the IC is mainly dissipated through the thermal pad. Maximizing the copper area connected to the thermal pad is preferable. In addition, a solid ground plane is helpful for better EMI performance. Refer to [TB389](#) for via placement on the copper area of the PCB underneath the thermal pad for optimal thermal performance.

ISL7823xEVAL2Z Schematics

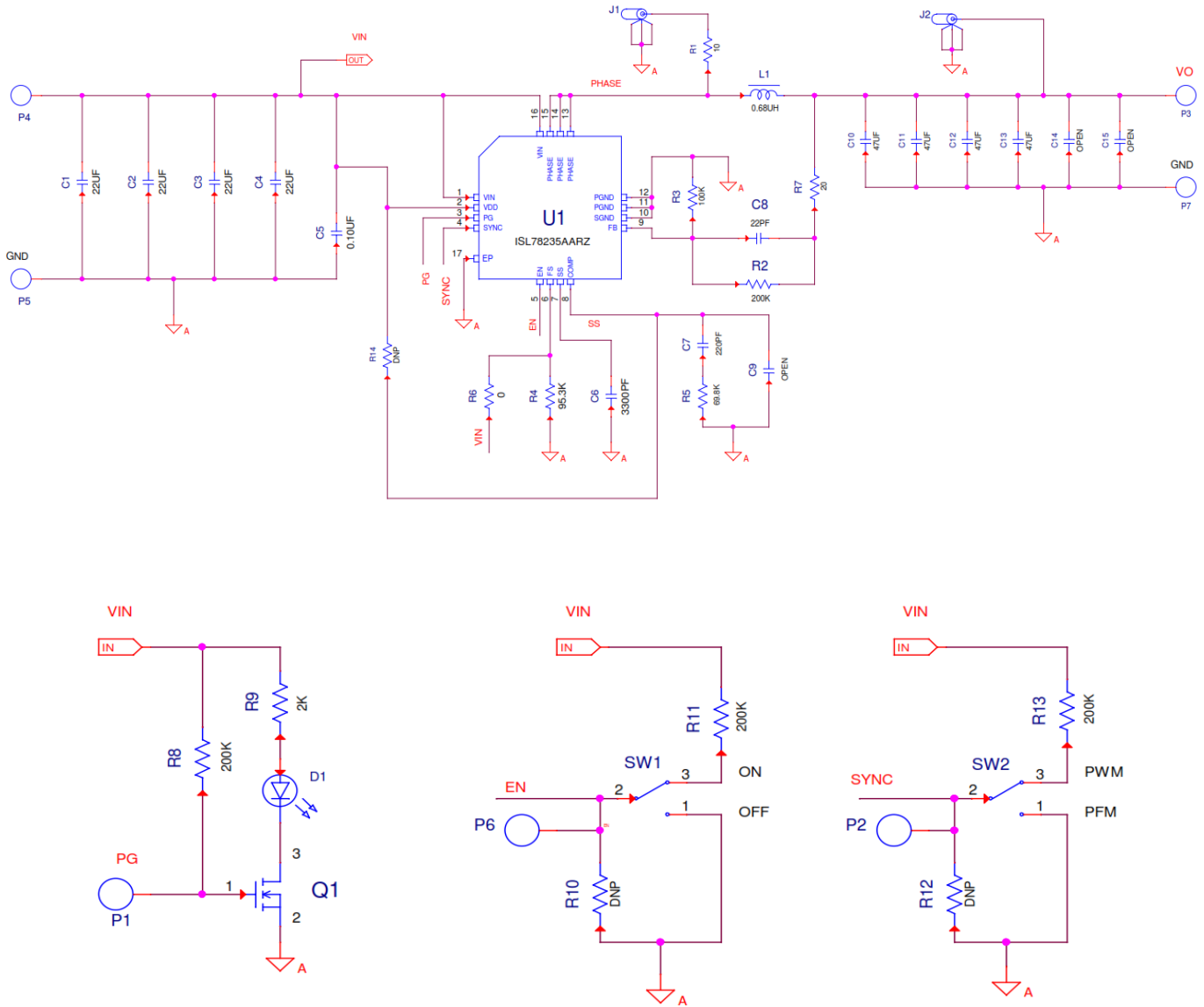

NOTES:

3. ISL78235EVAL2Z schematics are shown.
4. ISL78233EVAL2Z and ISL78234EVAL2Z schematics are equivalent.

FIGURE 4. ISL7823xEVAL2Z SCHEMATICS

Bill Of Materials

MANUFACTURER PART	QTY	REFERENCE DESIGNATOR	VALUE	TOL.	VOLTAGE	POWER	PACKAGE TYPE	DESCRIPTION	MANUFACTURER
ISL78233AARZ or ISL78234AARZ or ISL78235AARZ	1	U1					WFQFN16	3A, 4A, 5A Compact Synchronous Buck Regulator	INTERSIL
0603ZC104K4T2A	1	C5	0.10µF	10%	10V		603	Ceramic Chip Cap (Automotive AEC-Q200)	AVX
131-4353-00	2	J1, J2					CONN	Scope Probe Test Point PCB Mount	TEKTRONIX
2N7002	1	Q1					SOT23	N-Channel EMF Effect Transistor	FAIRCHILD
AUTO-CAP-SM0603-OPEN	1	C9	DNP				603	Ceramic Chip Cap (Automotive AEC-Q200)	Generic
AUTO-RES-SM0603-DNP	3	R10, R12, R14	DNP				603	Film Chip Resistor (Automotive AEC-Q200)	Generic
C0603C332K4RACAUTO	1	C6	3300pF	10%	16V		603	Ceramic Chip Cap (Automotive AEC-Q200)	Kemet
CGA3E2COG1H221J080AA	1	C7	220pF	5%	50V		603	Ceramic Chip Cap (Automotive AEC-Q200)	TDK
CRCW06030000Z0EA	1	R6	0	1%		1/10W	603	Film Chip Resistor (Automotive AEC-Q200)	VISHAY
CRCW0603100KFKEA	1	R3	100k	1%		1/10W	603	Film Chip Resistor (Automotive AEC-Q200)	VISHAY
CRCW0603200KFKEA	4	R2, R8, R11, R13	200k	1%		1/10W	603	Film Chip Resistor (Automotive AEC-Q200)	VISHAY
CRCW060320R0FKEA	1	R7	20	1%		1/10W	603	Film Chip Resistor (Automotive AEC-Q200)	VISHAY
CRCW06032K00FKEA	1	R9	2k	1%		1/10W	603	Film Chip Resistor (Automotive AEC-Q200)	VISHAY
CRCW060369K8FKEA	1	R5	69.8k	1%		1/10W	603	Film Chip Resistor (Automotive AEC-Q200)	VISHAY
CRCW060395K3FKEA	1	R4	95.3k	1%		1/10W	603	Film Chip Resistor (Automotive AEC-Q200)	VISHAY
GCM1885C1H220JA16D	1	C8	22pF	5%	50V		603	Ceramic Chip Cap (Automotive AEC-Q200)	Murata
GCM31CR71A226KE	2	C3, C4	22µF	10%	10V		1206	Ceramic Chip Cap (Automotive AEC-Q200)	Murata
GCM32ER71A226KE12L	2	C1, C2	22µF	10%	10V		1210	Ceramic Chip Cap (Automotive AEC-Q200)	Murata
GT11MSCKE	2	SW1, SW2					SMT	SPDT On-None-On SMT Ultraminature Toggle Switch	C&K
H1082-OPEN	2	C14, C15	DNP				1210	Ceramic Chip Cap	GENERIC
H2511-00100-1/16W1	1	R1	10	1%		1/16W	603	Thick Film Chip Resistor	GENERIC
IHLP-2020CZ-ER-R68-M-01	1	L1	0.68µH	20%		10.2A	SMD-S	Low Profile High Current Inductor	VISHAY
JMK325B7476KMHTR	4	C10-C13	47µF	10%	6.3V		1210	Ceramic Chip Cap (Automotive AEC-Q200)	Taiyo Yuden
LTST-C170CKT	1	D1					SMD	AlGaAs on GaAs Red LED	LITEON

ISL7823xEVAL2Z Board Layout

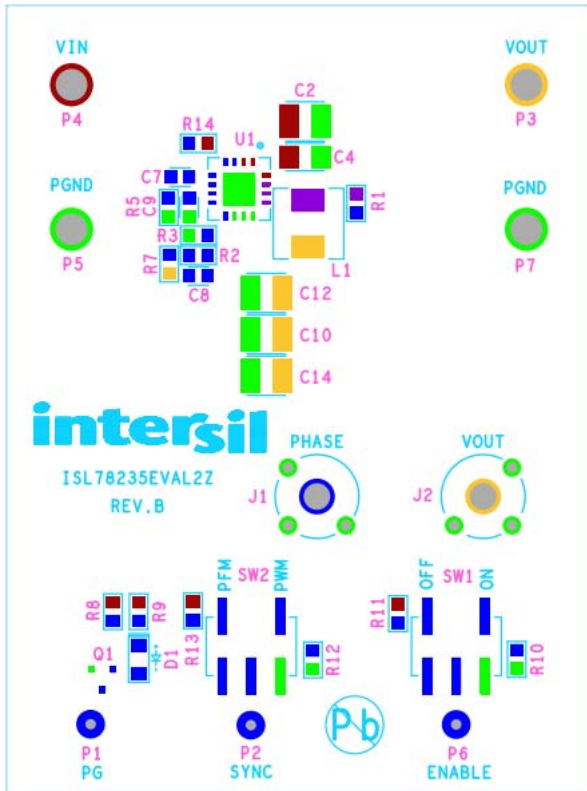

FIGURE 5. TOP LAYER SILKSCREEN

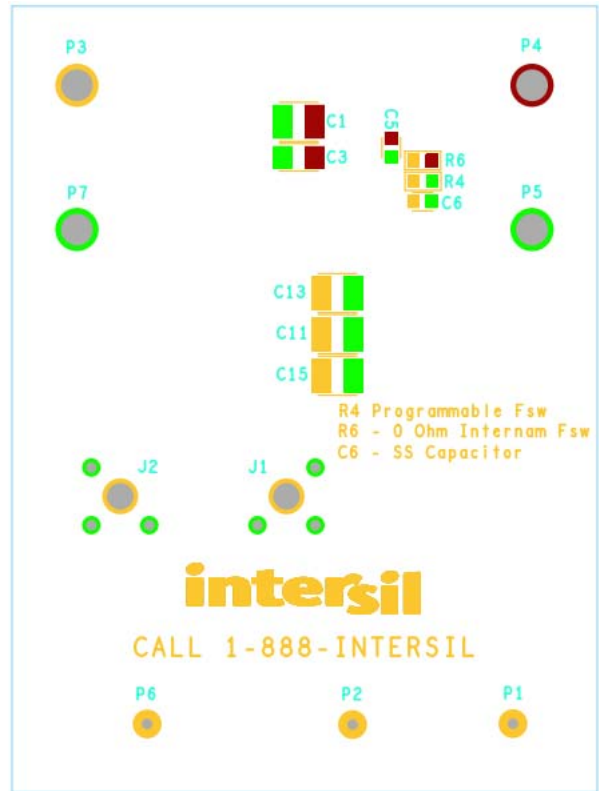

FIGURE 6. BOTTOM LAYER SILKSCREEN

NOTES:

- 5. ISL78233 board silkscreen name is ISL78233EVAL2Z
- 6. ISL78234 board silkscreen name is ISL78234EVAL2Z

ISL7823xEVAL2Z Board Layout (Continued)

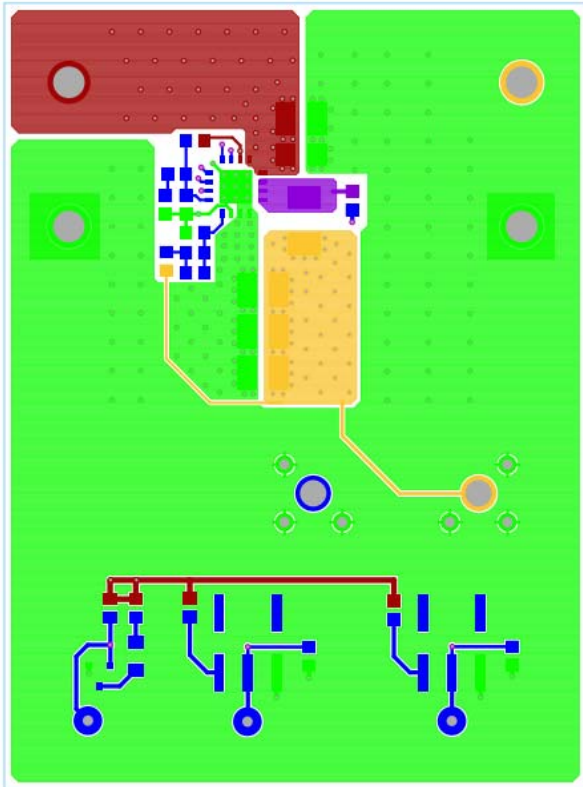

FIGURE 7. LAYER 1 PCB

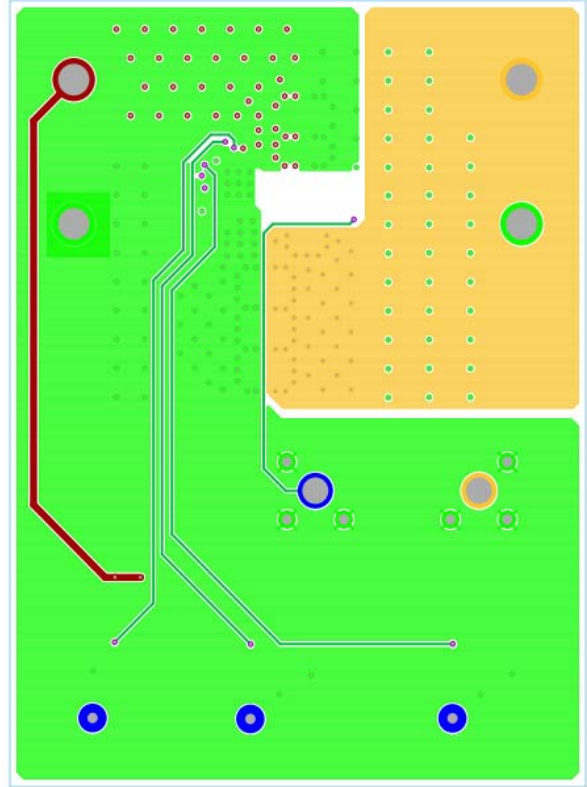

FIGURE 8. LAYER 2 PCB

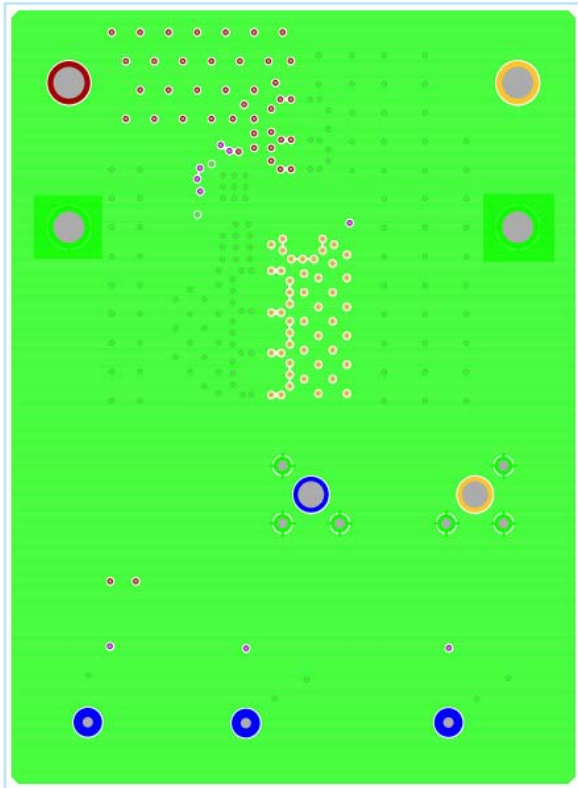

FIGURE 9. LAYER 3 PCB

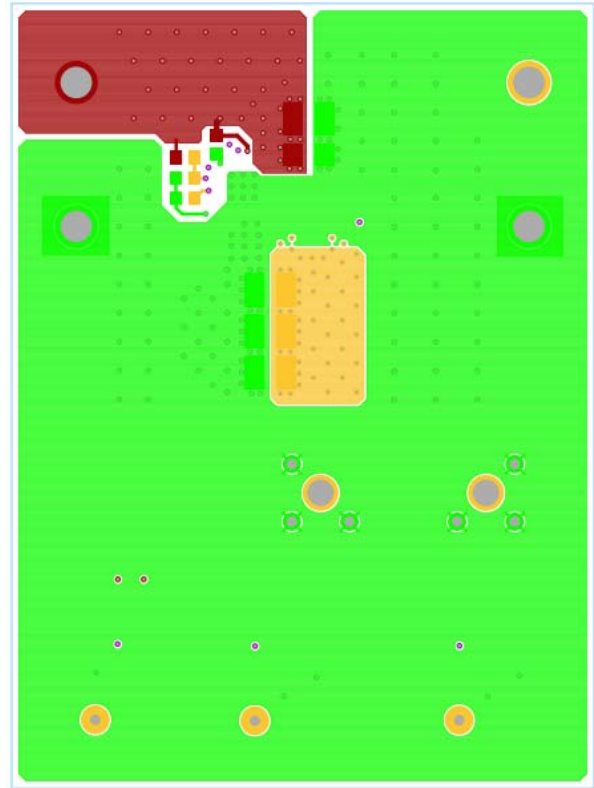

FIGURE 10. LAYER 4 PCB

Typical Performance Curves

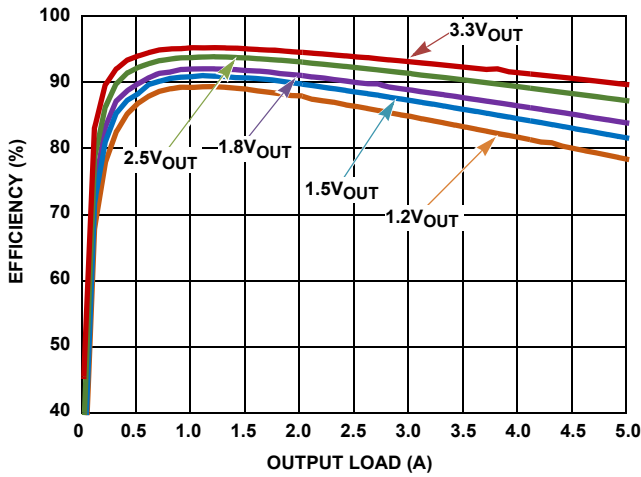

FIGURE 11. EFFICIENCY vs LOAD (5V_{IN}; SYNC = VDD)

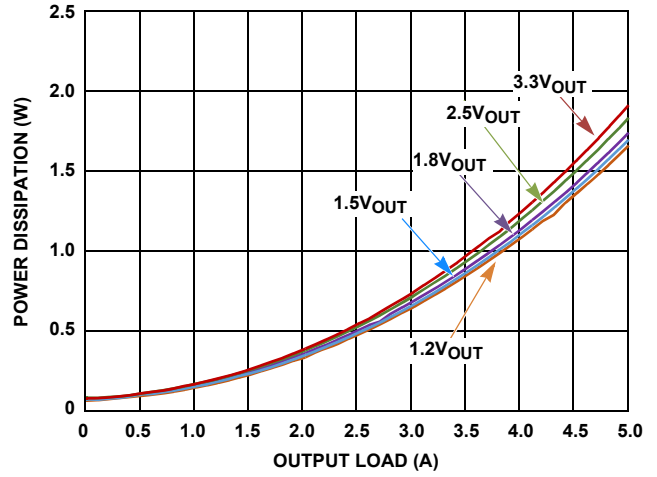

FIGURE 12. POWER DISSIPATION vs LOAD (5V_{IN}; SYNC = VDD)

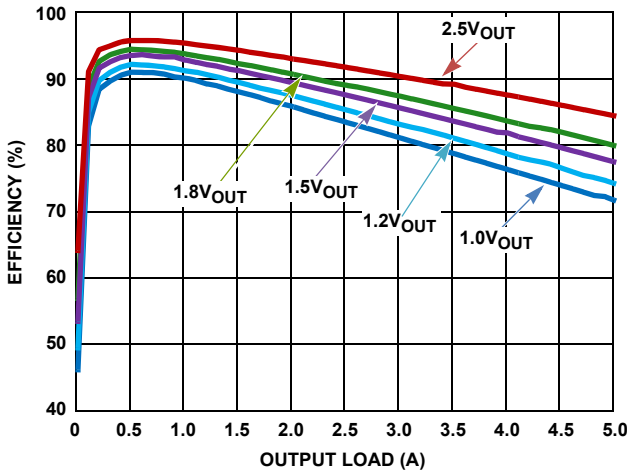

FIGURE 13. EFFICIENCY vs LOAD (3V_{IN}; SYNC = VDD)

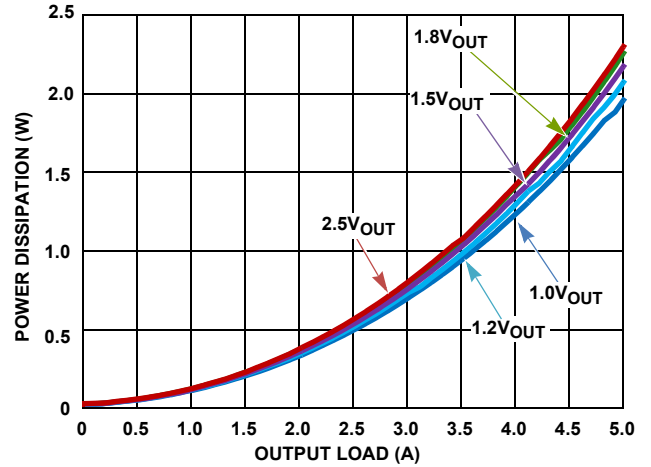

FIGURE 14. POWER DISSIPATION vs LOAD (3V_{IN}; SYNC = VDD)

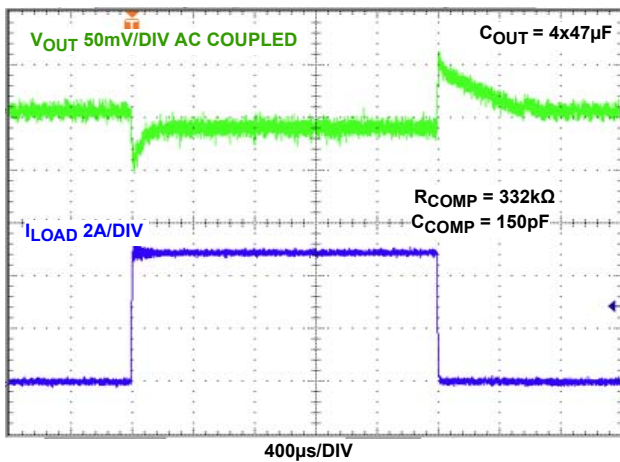

FIGURE 15. LOAD TRANSIENT 0A TO 5A; 0.5A/μs (SYNC = GND)

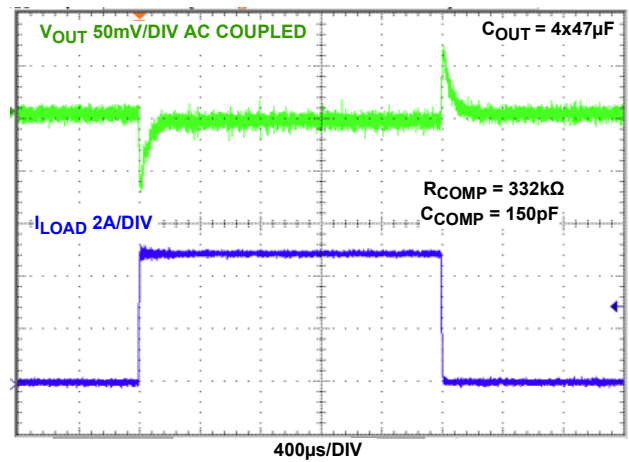

FIGURE 16. LOAD TRANSIENT 0A TO 5A; 0.5A/μs (SYNC = VDD)