

ISL78693

Automotive Single-Cell LiFePO4 Battery Charger

FN8891

Rev 1.00

December 12, 2016

The [ISL78693](#) is an integrated single-cell Li-ion or Li-polymer battery charger capable of operating with an input voltage as low as 2.65V (cold crank case). This charger is designed to work with various types of AC adapters or a USB port.

The ISL78693 operates as a linear charger when the AC adapter is a voltage source. The battery is charged in a Constant Current/Constant Voltage (CC/CV) profile. The charge current is programmable with an external resistor up to 1A. The ISL78693 can also work with a current-limited adapter to minimize the thermal dissipation.

The ISL78693 features charge current thermal foldback to ensure safe operation when the printed circuit board's thermal dissipation is limited due to space constraints. Additional features include preconditioning of an over-discharged battery, an NTC thermistor interface for charging the battery in a safe temperature range, and automatic recharge. The device is specified for operation in ambient temperatures from -40 °C to +85 °C and is offered in a 3x3mm thermally enhanced DFN package.

Related Literature

- For a full list of related documents, visit our website - [ISL78693](#) product page

Features

- Complete charger for single-cell Lithium chemistry batteries
- Integrated power transistor and current sensor
- Reverse battery leakage 700nA
- 1% initial voltage accuracy
- Programmable CC current up to 1A
- Charge current thermal foldback
- NTC thermistor interface for battery temperature alert
- Accepts CV and CC types of adapters or USB bus power
- Preconditioning trickle charge
- Guaranteed to operate down to 2.65V after start-up
- Ambient temperature range: -40 °C to +85 °C
- [AEC-Q100](#) qualified

Applications

- Automotive systems
- eCall systems
- Backup battery systems

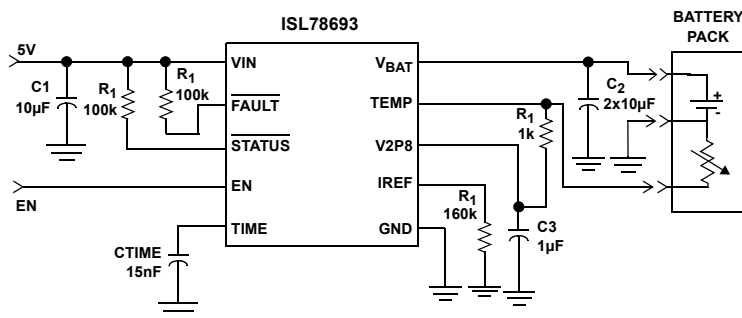

FIGURE 1. TYPICAL APPLICATION

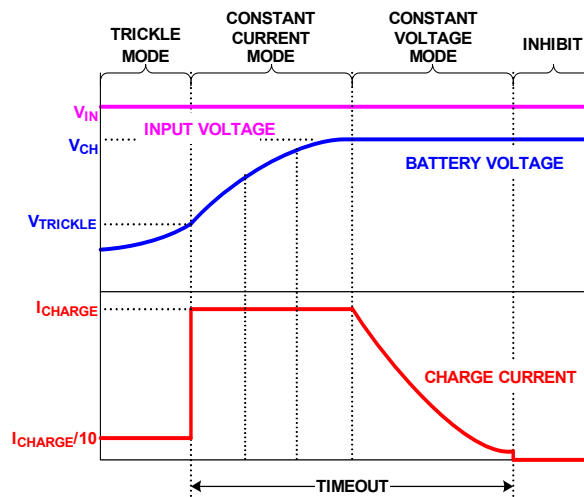

FIGURE 2. TYPICAL CHARGE CURVES USING A CONSTANT VOLTAGE ADAPTER

Block Diagram

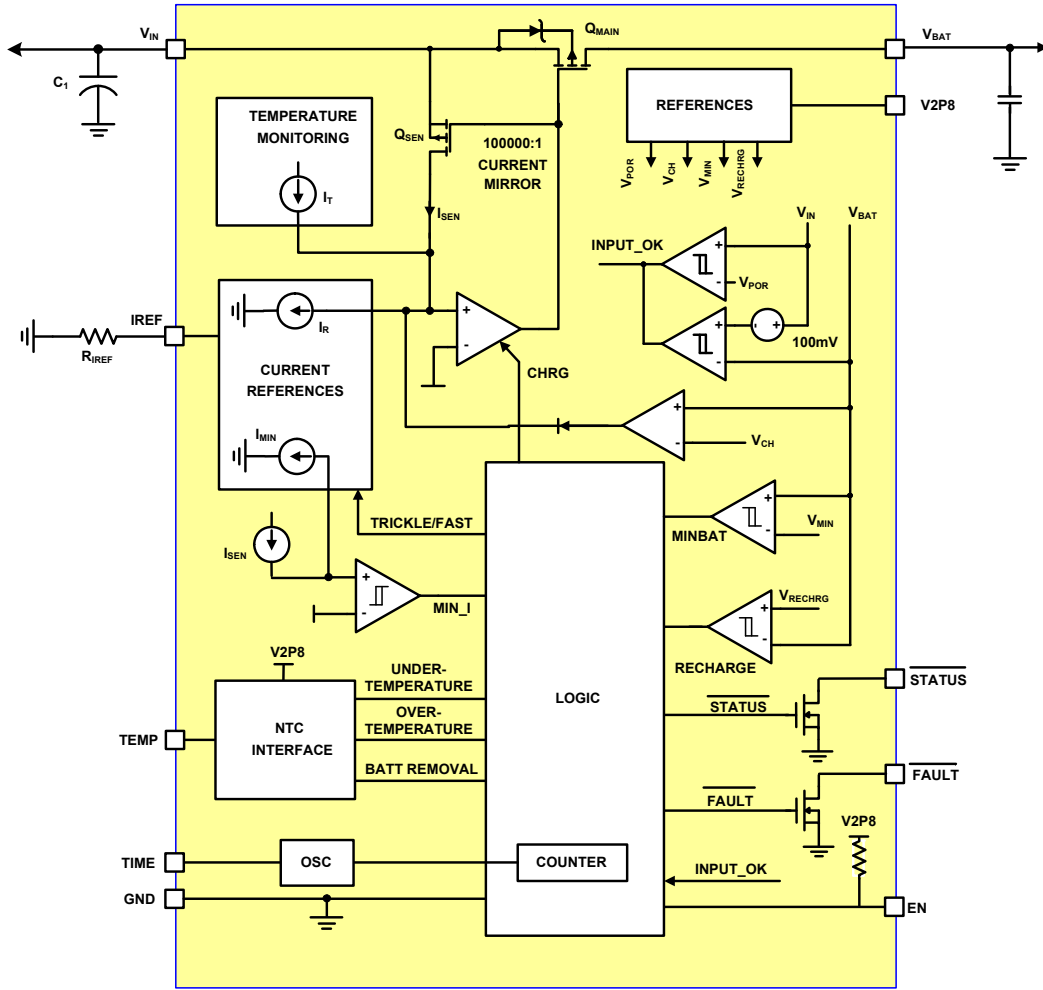

FIGURE 3. BLOCK DIAGRAM

TABLE 1. KEY DIFFERENCES BETWEEN FAMILY OF PARTS

PART NUMBER	OUTPUT VOLTAGE (V)	RECHARGE THRESHOLD (V)	TRICKLE CHARGE THRESHOLD (V)
ISL78692	4.1	3.9	2.8
ISL78693	3.65	3.25	2.6

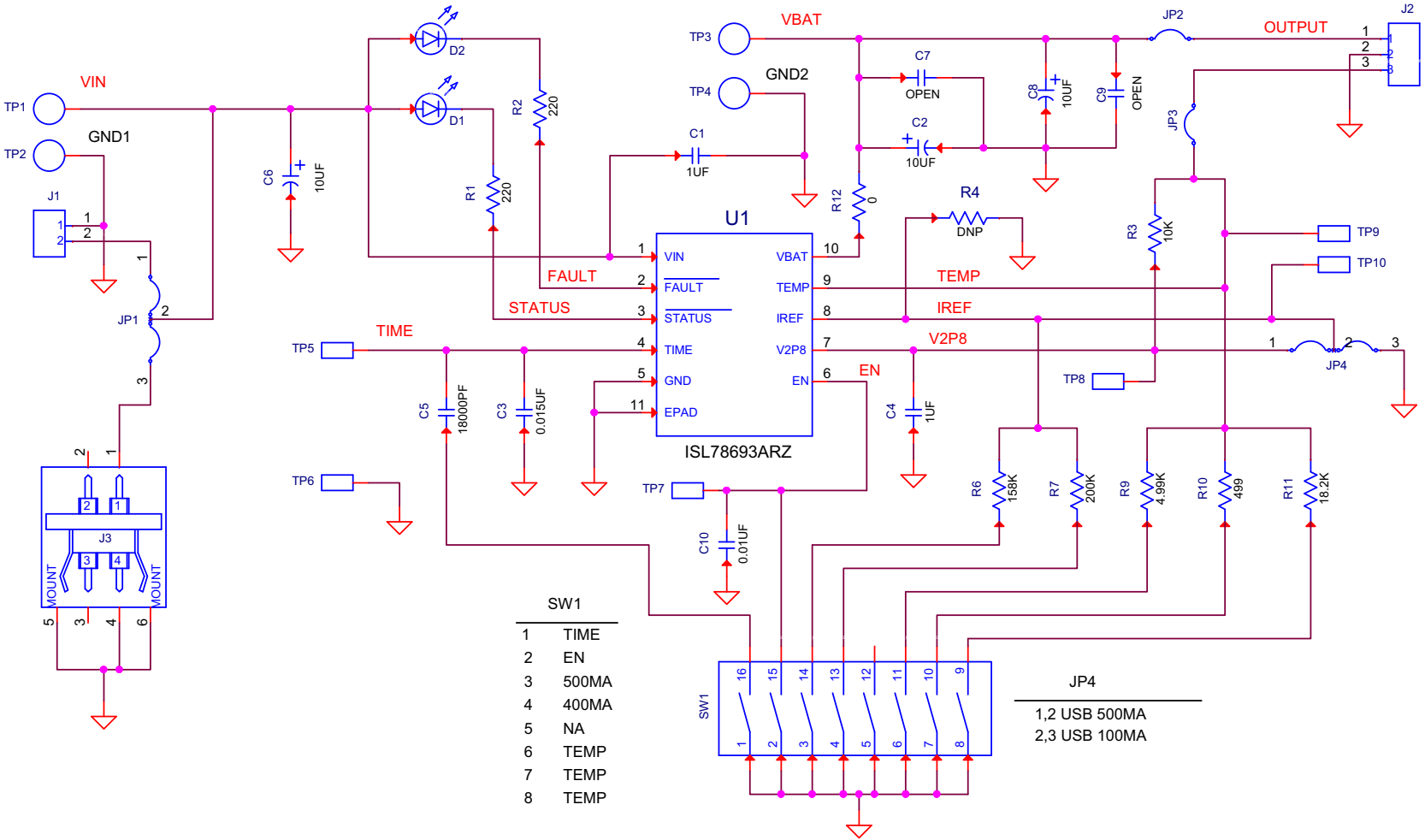
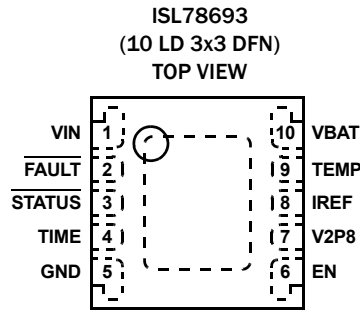

FIGURE 4. ISL78693EVAL1Z SCHEMATIC

- SW1
- 1 TIME
 - 2 EN
 - 3 500MA
 - 4 400MA
 - 5 NA
 - 6 TEMP
 - 7 TEMP
 - 8 TEMP

- JP4
- 1,2 USB 500MA
 - 2,3 USB 100MA

Pin Configuration



Pin Descriptions

PIN #	PIN NAME	DESCRIPTION
1	VIN	VIN is the input power source.
2	$\overline{\text{FAULT}}$	$\overline{\text{FAULT}}$ is an open-drain output indicating fault status. This pin is pulled to LOW under any fault conditions.
3	$\overline{\text{STATUS}}$	$\overline{\text{STATUS}}$ is an open-drain output indicating charging and inhibit states. The $\overline{\text{STATUS}}$ pin is pulled LOW when the charger is charging a battery.
4	TIME	The TIME pin determines the oscillation period by connecting a timing capacitor between this pin and GND. The oscillator also provides a time reference for the charger.
5	GND	GND is the connection to system ground.
6	EN	EN is the enable logic input. Connect the EN pin to LOW to disable the charger or leave it floating to enable the charger.
7	V2P8	The V2P8 is a 2.8V reference voltage output. The 2.8V is present when VIN is above 3.4V typical. If VIN falls below 2.4V typical the V2P8 output will be at 0V.
8	IREF	This is the programming input for the constant charging current.
9	TEMP	TEMP is the input for an external NTC thermistor. The TEMP pin is also used for battery removal detection.
10	VBAT	VBAT is the connection to the battery.
	EPAD	The metal slug on the bottom surface of the package is floating. Tie to system GND.

Ordering Information

PART NUMBER (Notes 1, 2, 3)	PART MARKING	TEMP RANGE (°C)	PACKAGE (RoHS COMPLIANT)	PKG DWG
ISL78693ARZ	8693	-40 to +85	10 Ld 3x3 DFN	L10.3x3
ISL78693EVAL1Z	Evaluation Board for the 3x3 DFN Package Part			

NOTE:

1. Add "-T" suffix for 6k unit or "T7A" for 250 unit tape and reel options. Refer to [TB347](#) for details on reel specifications.
2. These Intersil Pb-free plastic packaged products employ special Pb-free material sets, molding compounds/die attach materials, and 100% matte tin plate plus anneal (e3 termination finish, which is RoHS compliant and compatible with both SnPb and Pb-free soldering operations). Intersil Pb-free products are MSL classified at Pb-free peak reflow temperatures that meet or exceed the Pb-free requirements of IPC/JEDEC J STD-020.
3. For Moisture Sensitivity Level (MSL), see product information page for [ISL78693](#). For more information on MSL, see Technical Brief [TB363](#).

Absolute Maximum Ratings

Supply Voltage (VIN)	-0.3V to 7.0V
Output Pin Voltage (VBAT)	-0.3V to 5.5V
Output Pin Voltage (V2P8)	-0.3V to 3.2V
Signal Input Voltage (EN, TIME, IREF, TEMP)	-0.3V to 3.2V
Output Pin Voltage (STATUS, FAULT)	-0.3V to 7.0V
Charge Current	1.6A
ESD Rating:	
Human Body Model (Tested per AEC-Q100-002)	4kV
Charge Device Model (Tested per AEC-Q100-011)	1.25kV
Latch-up (Tested per AEC-Q100-004)	100mA

Thermal Information

Thermal Resistance (Typical)	θ_{JA} (°C/W)	θ_{JC} (°C/W)
3x3 DFN Package (Notes 4, 5)	46	4
Maximum Junction Temperature	+150°C	
Maximum Storage Temperature Range	-65°C to +150°C	
Pb-Free Reflow Profile	see TB493	

Recommended Operating Conditions

Ambient Temperature Range	-40°C to +85°C
Supply Voltage, VIN	4.3V to 5.5V

CAUTION: Do not operate at or near the maximum ratings listed for extended periods of time. Exposure to such conditions may adversely impact product reliability and result in failures not covered by warranty.

NOTES:

- θ_{JA} is measured in free air with the component mounted on a high-effective thermal conductivity test board with “direct attach” features. See Tech Brief [TB379](#).
- For θ_{JC} , “case temperature” location is at the center of the exposed metal pad on the package underside. See Tech Brief [TB379](#).

Electrical Specifications Typical values are tested at $V_{IN} = 5V$ and at an ambient temperature of +25°C, unless otherwise noted. **Boldface limits apply across the operating temperature range, -40°C to +85°C and V_{IN} range of 4.3V to 5.5V** (see [Note 6](#)).

PARAMETER	SYMBOL	TEST CONDITIONS	MIN (Note 6)	TYP	MAX (Note 6)	UNIT
POWER-ON RESET						
Rising V_{IN} Threshold			2.90	3.35	3.70	V
Falling V_{IN} Threshold			2.30	2.55	2.80	V
STANDBY CURRENT						
VBAT Pin Leakage	IVBLKG	$V_{BAT} = 5.5V, V_{IN} = 0V, EN = 0.8V$		0.7	3.0	μA
VIN Pin Standby Current	I_{INSBY}	$V_{BAT} OPEN, V_{IN} = 5.0V, EN = 0.8V$		30	200	μA
VIN Pin Quiescent Current	I_Q	$V_{BAT} OPEN, V_{IN} = 5.5V, EN FLOAT$		1.0	1.5	mA
VOLTAGE REGULATION						
Output Voltage	V_{CH}	$V_{BAT} OPEN$	3.55	3.65	3.75	V
Dropout Voltage	V_{DO}	$V_{BAT} = 3.0V, I_{IN} = 500mA$		270	450	mV
CHARGE CURRENT						
Constant Charge Current (Note 8)	I_{CHARGE}	$R_{IREF} = 160k\Omega, V_{BAT} = 3.0V$	430	500	570	mA
Trickle Charge Current	$I_{TRICKLE}$	$R_{IREF} = 160k\Omega, V_{BAT} = 2.1V$		55		mA
Constant Charge Current (Note 8)	I_{CHARGE}	IREF pin voltage > 1.2V, $V_{BAT} = 3.0V$	390	450	540	mA
Trickle Charge Current	$I_{TRICKLE}$	IREF pin voltage > 1.2V, $V_{BAT} = 2.1V$		45		mA
Constant Charge Current (Note 8)	I_{CHARGE}	IREF pin voltage < 0.4V, $V_{BAT} = 3.0V$	65	80	104	mA
Trickle Charge Current	$I_{TRICKLE}$	IREF pin voltage < 0.4V, $V_{BAT} = 2.1V$		10		mA
End-of-Charge Current	I_{EOC}		35	60	100	mA
RECHARGE THRESHOLD						
Recharge Voltage Falling Threshold	V_{RECHRG}		3.00	3.25	3.40	V
TRICKLE CHARGE THRESHOLD						
Trickle Charge Threshold Voltage	$V_{TRICKLE}$		2.2	2.6	3.0	V

Electrical Specifications Typical values are tested at $V_{IN} = 5V$ and at an ambient temperature of $+25^{\circ}C$, unless otherwise noted. **Boldface limits apply across the operating temperature range, $-40^{\circ}C$ to $+85^{\circ}C$ and V_{IN} range of 4.3V to 5.5V** (see [Note 6](#)).

PARAMETER	SYMBOL	TEST CONDITIONS	MIN (Note 6)	TYP	MAX (Note 6)	UNIT
TEMPERATURE MONITORING						
Low Temperature Threshold	V_{TMIN}	V2P8 = 3.0V	1.45	1.51	1.57	V
High Temperature Threshold	V_{TMAX}	V2P8 = 3.0V	0.36	0.38	0.40	V
Battery Removal Threshold (Note 7)	V_{RMV}	V2P8 = 3.0V, Voltage on temperature	2.10	2.25	3.00	V
Charge Current Foldback Threshold	T_{FOLD}	Junction temperature	85	100	125	$^{\circ}C$
Current Foldback Gain (Note 7)	G_{FOLD}			100		mA/ $^{\circ}C$
OSCILLATOR						
Oscillation Period	t_{OSC}	$C_{TIME} = 15nF$	2.2	2.7	3.6	ms
LOGIC INPUT AND OUTPUT						
EN Input Low					0.8	V
IREF Input High			1.2			V
IREF Input Low					0.4	V
STATUS/ FAULT Sink Current		Pin voltage = 0.8V	5	11		mA

NOTES:

6. The Parameters with MIN and/or MAX limits are 100% tested at $+25^{\circ}C$, unless otherwise specified. Temperature limits established by characterization and are not production tested.
7. This parameter is not tested in production.
8. Measured using pulse load.

Typical Operating Performance

The test conditions for the typical operating performance are: $V_{IN} = 5V$, $T_A = +25^\circ C$, $R_{IREF} = 160k\Omega$, $V_{BAT} = 3.7V$, unless otherwise noted.

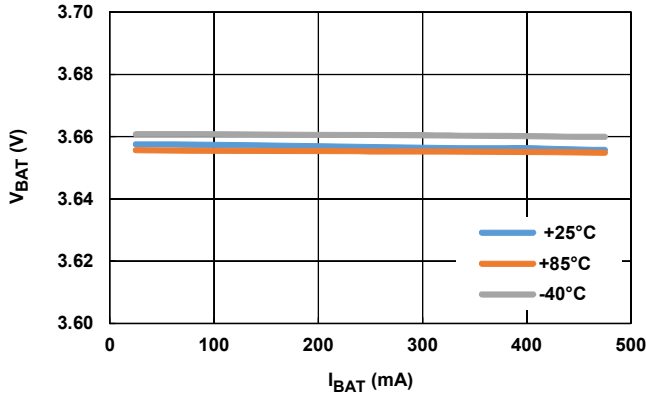

FIGURE 5. VOLTAGE REGULATION vs CHARGE CURRENT

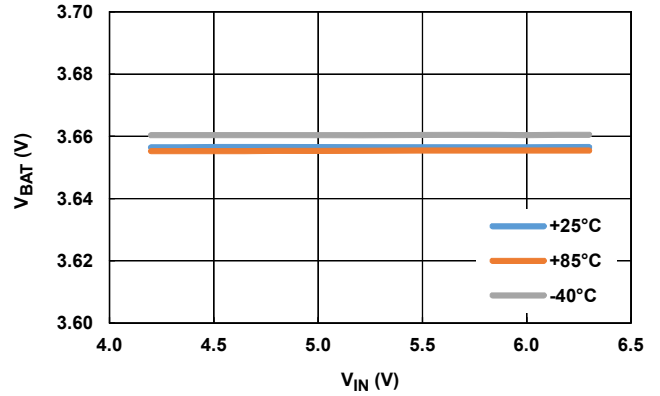

FIGURE 6. NO LOAD VOLTAGE vs TEMPERATURE

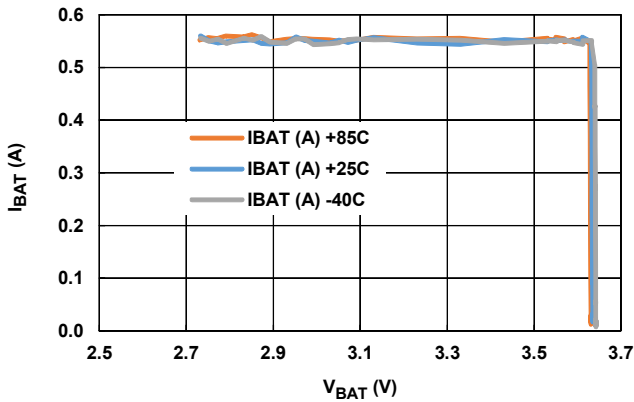

FIGURE 7. CHARGE CURRENT vs OUTPUT VOLTAGE, $R_{IREF} = 158k$

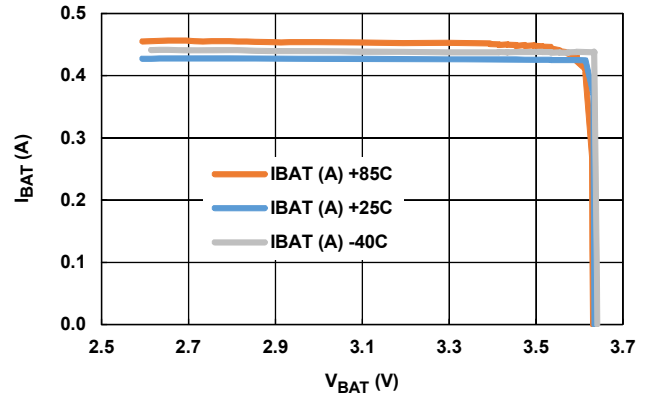

FIGURE 8. CHARGE CURRENT vs OUTPUT VOLTAGE, $R_{IREF} = 200k$

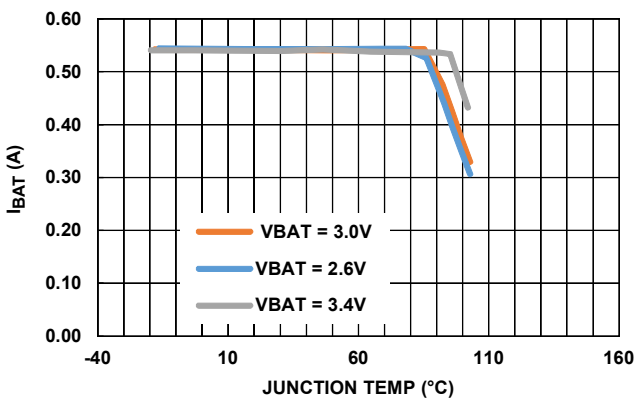

FIGURE 9. CHARGE CURRENT vs JUNCTION TEMPERATURE, $R_{IREF} = 158k$

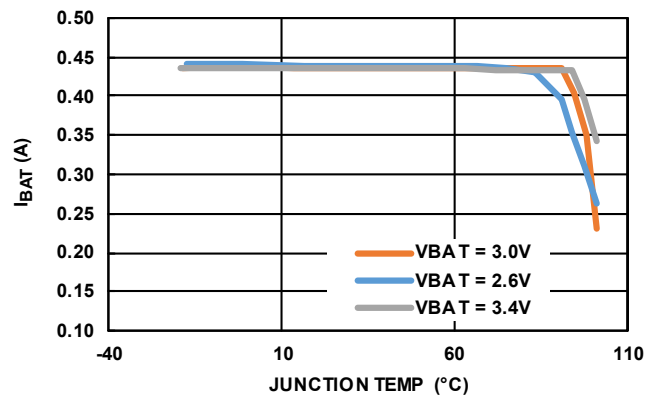

FIGURE 10. CHARGE CURRENT vs JUNCTION TEMPERATURE, $R_{IREF} = 200k$

Typical Operating Performance

The test conditions for the typical operating performance are: $V_{IN} = 5V$,

$T_A = +25^\circ C$, $R_{IREF} = 160k\Omega$, $V_{BAT} = 3.7V$, unless otherwise noted. (Continued)

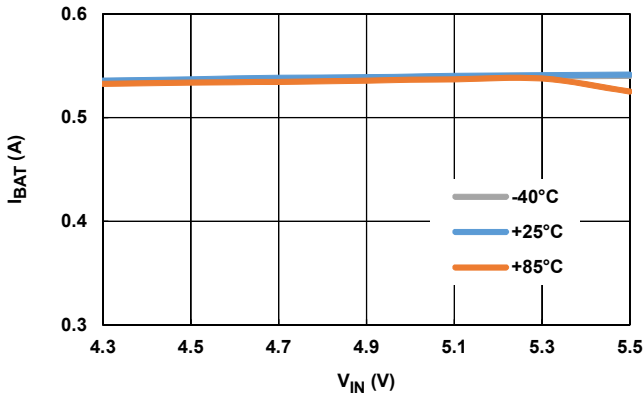

FIGURE 11. CHARGE CURRENT vs INPUT VOLTAGE, $V_{BAT} = 3V$, $R_{IREF} = 158k$

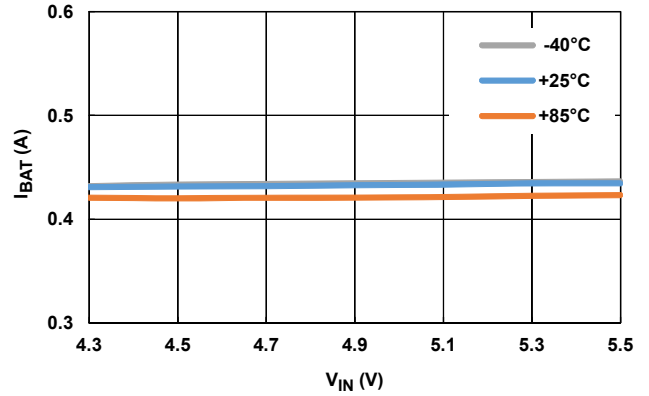

FIGURE 12. CHARGE CURRENT vs INPUT VOLTAGE, $V_{BAT} = 3V$, $R_{IREF} = 200k$

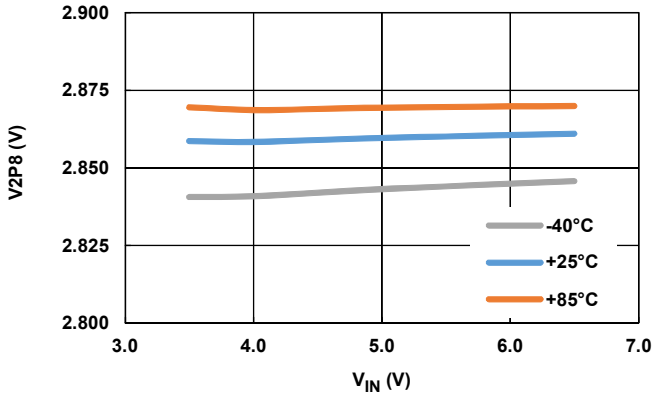

FIGURE 13. V2P8 OUTPUT vs INPUT VOLTAGE AT NO LOAD

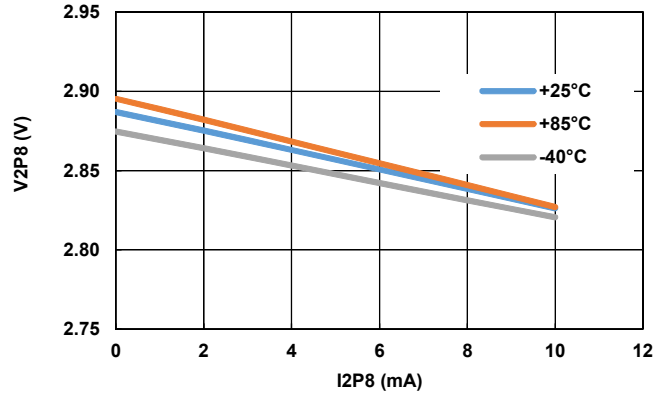

FIGURE 14. V2P8 OUTPUT vs LOAD CURRENT

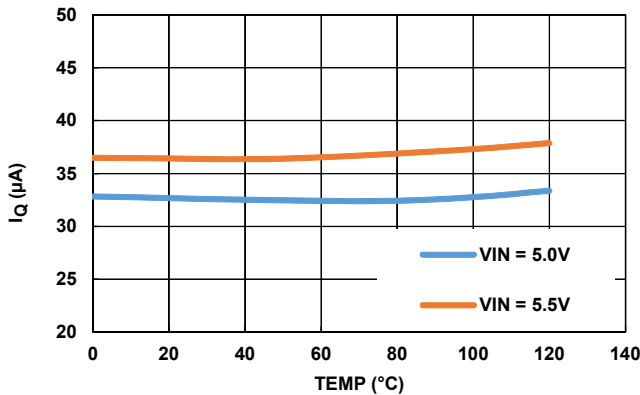

FIGURE 15. INPUT QUIESCENT CURRENT vs TEMPERATURE

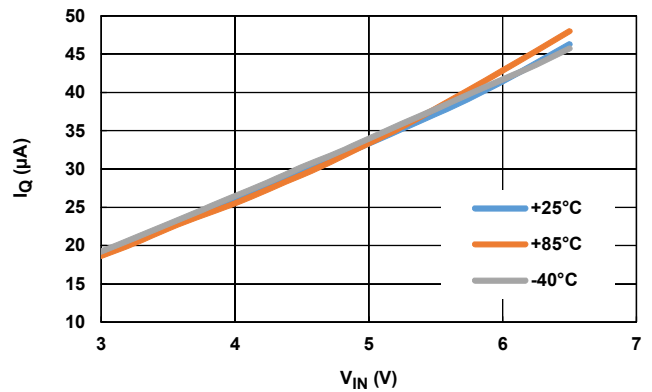

FIGURE 16. INPUT QUIESCENT CURRENT vs INPUT VOLTAGE, SHUTDOWN

Typical Operating Performance

The test conditions for the typical operating performance are: $V_{IN} = 5V$, $T_A = +25^\circ C$, $R_{IREF} = 160k\Omega$, $V_{BAT} = 3.7V$, unless otherwise noted. (Continued)

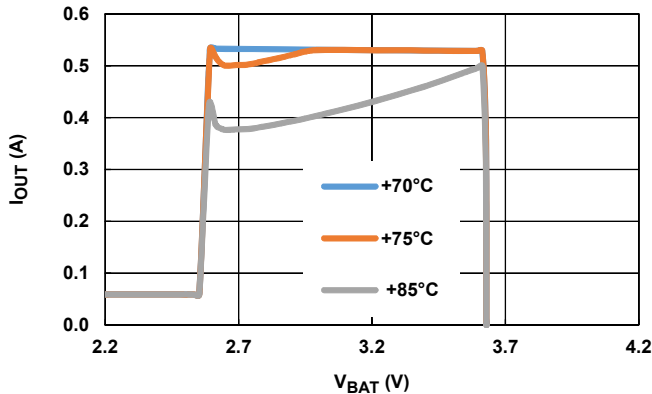

FIGURE 17. V_{BAT} vs I_{OUT} vs AMBIENT TEMPERATURE, $R_{IREF} = 200k$, $V_{IN} = 5.5V$, AIR FLOW = 0 LFM, MEASURED ON THE ISL78693EVAL1Z BOARD

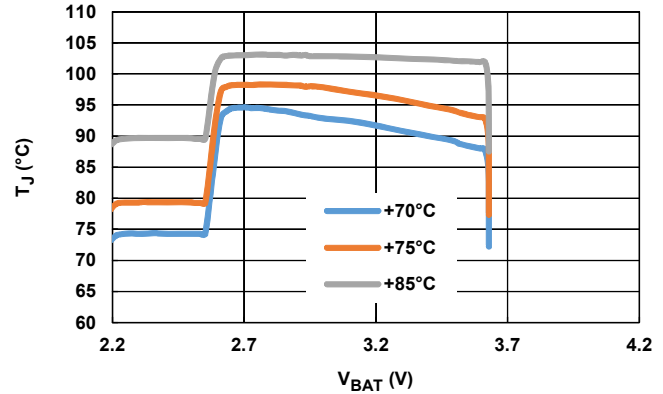

FIGURE 18. JUNCTION TEMPERATURE vs V_{BAT} vs AMBIENT TEMPERATURE, $R_{IREF} = 200k$, $V_{IN} = 5.5V$, AIR FLOW = 0 LFM, MEASURED ON THE ISL78693EVAL1Z BOARD

Theory of Operation

The ISL78693 is an integrated charger for single-cell Lithium chemistry batteries. The ISL78693 functions as a traditional linear charger when powered with a voltage source adapter. When powered with a current-limited adapter, the charger minimizes the thermal dissipation commonly seen in traditional linear chargers.

As a linear charger, the ISL78693 charges a battery in the popular Constant Current (CC) and Constant Voltage (CV) profile. The constant charge current I_{REF} is programmable up to 1A with an external resistor or a logic input. The charge voltage V_{CH} has 1% accuracy over the entire recommended operating condition range. The charger preconditions the battery with a 10% typical of the programmed current at the beginning of a charge cycle until the battery voltage is verified to be above the minimum fast charge voltage, $V_{TRICKLE}$. This low current preconditioning charge mode is named Trickle mode. The verification takes 15 cycles of an internal oscillator whose period is programmable with a timing capacitor on the time pin. A thermal-foldback feature protects the device from the thermal concern typically seen in linear chargers. The charger reduces the charge current automatically as the IC internal temperature rises above $+100^\circ C$ to prevent further temperature rise. The thermal-foldback feature ensures safe operation when the Printed Circuit Board (PCB) is space limited for thermal dissipation.

A TEMP pin monitors the battery temperature to ensure a safe charging temperature range. The temperature range is programmable with an external negative temperature coefficient (NTC) thermistor. The TEMP pin is also used to detect the removal of the battery.

The charger offers a safety timer for setting the fast charge time (TIMEOUT) limit to prevent charging a dead battery for an extensively long time. The Trickle mode is limited to 1/8 of TIMEOUT.

The charger automatically recharges the battery when the battery voltage drops below a recharge threshold of 3.3V (typical). When the input supply is not present, the ISL78693 draws less than $1\mu A$ current from the battery.

Three indication pins are available from the charger to indicate the charge status. The V2P8 outputs a 2.8VDC voltage when the input voltage is above the Power-On Reset (POR) level and can be used as the power-present indication. This pin is capable of sourcing a 2mA current, so it can also be used to bias external circuits. The STATUS pin is an open-drain, logic output that turns LOW at the beginning of a charge cycle until the End-of-charge (EOC) condition is qualified. The EOC condition is when the battery voltage rises above the recharge threshold and the charge current falls below a preset of a tenth of the programmed charge current. Once the EOC condition is qualified, the STATUS output rises to HIGH and is latched. The latch is released at the beginning of a charge or recharge cycle. The open-drain FAULT pin turns low when any fault conditions occur. The fault conditions include the external battery temperature fault, a charge time fault, or the battery removal.

Figure 19 on page 10 shows the typical charge curves in a traditional linear charger powered with a constant voltage adapter. From top to bottom, the curves represent the constant input voltage, the battery voltage, the charge current, and the power dissipation in the charger. The power dissipation P_{CH} is given by Equation 1:

$$P_{CH} = (V_{IN} - V_{BAT}) \cdot I_{CHARGE} \quad (\text{EQ. 1})$$

where I_{CHARGE} is the charge current. The maximum power dissipation occurs during the beginning of the CC mode. The maximum power the IC is capable of dissipating is dependent on the thermal impedance of the Printed Circuit Board (PCB). Figure 19 shows (with dotted lines) two cases that the charge currents are limited by the maximum power dissipation capability due to the thermal foldback.

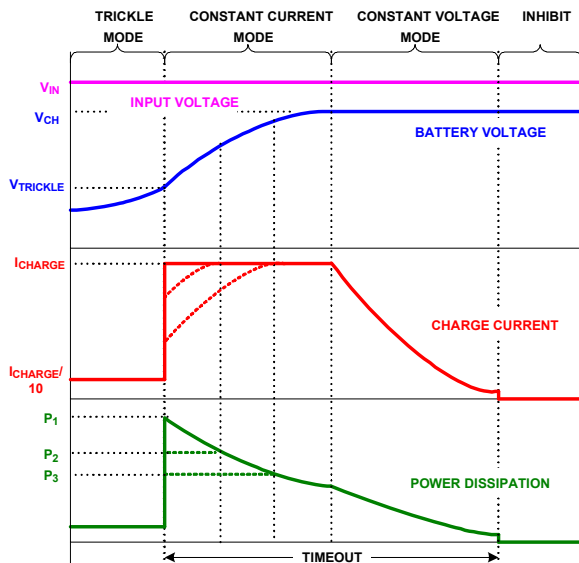

FIGURE 19. TYPICAL CHARGE CURVES USING A CONSTANT VOLTAGE ADAPTER

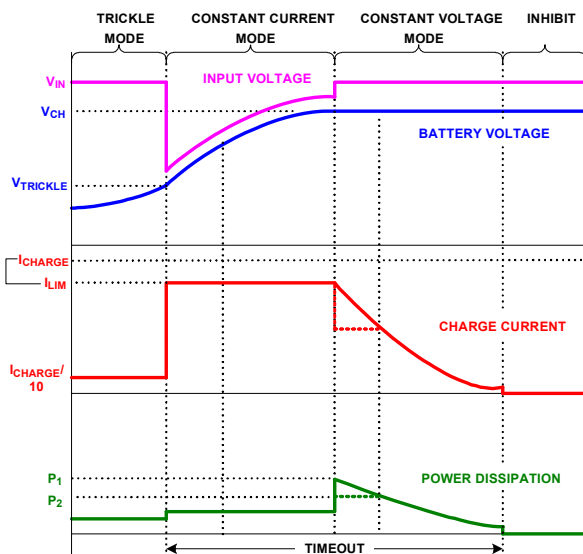

FIGURE 20. TYPICAL CHARGE CURVES USING A CURRENT-LIMITED ADAPTER

When using a current-limited adapter, the thermal situation in the ISL78693 is totally different. [Figure 20](#) shows the typical charge curves when a current-limited adapter is employed. The operation requires the I_{REF} to be programmed higher than the limited current I_{LIM} of the adapter. The key difference of the charger operating under such conditions occurs during the CC mode.

The [“Block Diagram” on page 2](#) aids in understanding the operation. The current loop consists of the current amplifier CA and the sense MOSFET (Q_{SEN}). The current reference I_R is programmed by the I_{REF} pin. The current amplifier CA regulates the gate of the sense MOSFET (Q_{SEN}) to ensure that the sensed current I_{SEN} matches the reference current I_R . The main MOSFET, Q_{MAIN} and the sense MOSFET (Q_{SEN}) form a current

mirror with a ratio of 100,000:1, which the output charge current is 100,000 times I_R . In the CC mode, the current loop tries to increase the charge current by enhancing the sense MOSFET (Q_{SEN}), in which the sensed current matches the reference current. On the other hand, if the adapter current is limited, the actual output current will never meet what is required by the current reference. As a result, the current error amplifier, CA, keeps enhancing the Q_{SEN} as well as the main MOSFET Q_{MAIN} until they are fully turned on. Therefore, the main MOSFET becomes a power switch instead of a linear regulation device. The power dissipation in the CC mode becomes [Equation 2](#):

$$P_{CH} = r_{DS(ON)} \cdot I_{CHARGE}^2 \quad (\text{EQ. 2})$$

where $r_{DS(ON)}$ is the resistance when the main MOSFET is fully turned on. This power is typically much less than the peak power in the traditional linear mode.

The worst power dissipation when using a current-limited adapter typically occurs at the beginning of the CV mode, as shown in [Figure 20](#).

[Equation 1](#) applies during the CV mode. When using a very small PCB whose thermal impedance is relatively large, it is possible that the internal temperature can still reach the thermal foldback threshold. In that case, the IC is thermally protected by lowering the charge current, as shown with the dotted lines in the charge current and power curves. Appropriate design of the adapter can further reduce the peak power dissipation of the ISL78693. See [“Applications Information”](#) for more information.

[Figure 21 on page 11](#) illustrates the typical signal waveforms for the linear charger from the power-up to a recharge cycle. More detailed information is given in the following sections.

Applications Information

Power-On Reset (POR)

The ISL78693 resets itself as the input voltage rises above the POR rising threshold. The V2P8 pin outputs a 2.8V voltage, the internal oscillator starts to oscillate, the internal timer is reset, and the charger begins to charge the battery. The two indication pins, $\overline{\text{STATUS}}$ and $\overline{\text{FAULT}}$, indicate a LOW and a HIGH logic signal respectively. [Figure 21](#) illustrates the start-up of the charger between t_0 to t_2 .

The ISL78693 has a typical rising POR threshold of 3.4V and a falling POR threshold of 2.4V. The 2.4V falling threshold guarantees charger operation with a current-limited adapter to minimize the thermal dissipation.

Charge Cycle

A charge cycle consists of three charge modes: Trickle mode, Constant Current (CC) mode, and Constant Voltage (CV) mode. The charge cycle always starts with the Trickle mode until the battery voltage stays above $V_{TRICKLE}$ (2.8V typical) for 15 consecutive cycles of the internal oscillator. If the battery voltage drops below $V_{TRICKLE}$ during the 15 cycles, the 15-cycle counter is reset and the charger stays in the Trickle mode. The charger moves to the CC mode after verifying the battery voltage. As the battery pack terminal voltage rises to the final charge voltage V_{CH} , the CV mode begins. The terminal voltage is regulated at the

constant V_{CH} in the CV mode and the charge current starts to reduce towards zero. After the charge current drops below I_{EOC} programmed to $1/10$ of I_{REF} (see “[End-of-Charge \(EOC\) Current](#)” on page 12 for more information), the ISL78693 indicates the EOC with the \overline{STATUS} pin. The charging actually does not terminate until the internal timer completes its length of $TIMEOUT$ in order to bring the battery to its full capacity. Signals in a charge cycle are illustrated in [Figure 21](#) between points t_2 to t_5 .

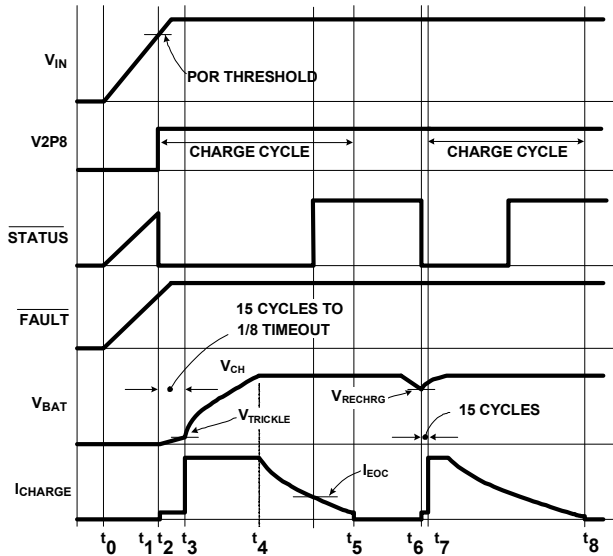

FIGURE 21. OPERATION WAVEFORMS

The following events initiate a new charge cycle:

- POR
- A new battery being inserted (detected by TEMP pin)
- The battery voltage drops below a recharge threshold after completing a charge cycle
- Recovery from a battery over-temperature fault
- The EN pin is toggled from GND to floating
- Further description of these events are given later in this datasheet

Recharge

After a charge cycle completes, charging is prohibited until the battery voltage drops to a recharge threshold, V_{RECHRG} of 3.3V (TYP), (see “[Electrical Specifications](#)” on page 5”). Then a new charge cycle starts at point t_6 and ends at point t_8 , as shown in [Figure 21](#). The safety timer is reset at t_6 .

Internal Oscillator

The internal oscillator establishes a timing reference. The oscillation period is programmable with an external timing capacitor, C_{TIME} , as shown in [Figure 1](#). The oscillator charges the timing capacitor to 1.5V and then discharges it to 0.5V in one period, both with $10\mu A$ current. The period t_{OSC} is given by [Equation 3](#):

$$t_{OSC} = 0.2 \cdot 10^6 \cdot C_{TIME} \quad (\text{seconds}) \quad (\text{EQ. 3})$$

A 1nF capacitor results in a 0.2ms oscillation period. The accuracy of the period is mainly dependent on the accuracy of the capacitance and the internal current source.

Total Charge Time

The total charge time for the CC mode and CV mode is limited to a length of $TIMEOUT$. A 22-stage binary counter increments each oscillation period of the internal oscillator to set the $TIMEOUT$. The $TIMEOUT$ can be calculated in [Equation 4](#):

$$TIMEOUT = 2^{22} \cdot \left(\frac{t_{OSC}(\text{SEC})}{60} \right) = 14 \cdot \frac{C_{TIME}}{1\text{nF}} (\text{minutes}) \quad (\text{EQ. 4})$$

A 1nF capacitor leads to 14 minutes of $TIMEOUT$. For example, a 15nF capacitor sets the $TIMEOUT$ to be 3.5 hours. The charger has to reach the end-of-charge condition before the $TIMEOUT$, otherwise, a $TIMEOUT$ fault is issued. The $TIMEOUT$ fault latches up the charge and the \overline{FAULT} pin goes low. There are two ways to release such a latch-up: either recycle the input power or toggle the EN pin to disable the charger and then enable it again.

The Trickle Charge mode has a time limit of $1/8$ $TIMEOUT$. If the battery voltage does not reach $V_{TRICKLE}$ within this limit, a $TIMEOUT$ fault is issued and the charger latches off. The charger stays in Trickle mode for at least 15 cycles of the internal oscillator and, at most, $1/8$ of $TIMEOUT$, as shown in [Figure 21](#).

Charge Current Programming

The charge current is programmed by the IREF pin. There are three ways to program the charge current:

1. Driving the IREF pin above 1.2V.
2. Driving the IREF pin below 0.4V.
3. Using the R_{IREF} as shown in “[TYPICAL APPLICATION](#)” on page 1.

The voltage of I_{REF} is regulated to a 0.8V reference voltage when not driven by any external source. The charging current during the Constant Current mode is 100,000 times that of the current in the R_{IREF} resistor. Therefore, depending on how IREF pin is used, the charge current is given by [Equation 5](#):

$$I_{REF} = \begin{cases} 500\text{mA} & V_{IREF} > 1.2\text{V} \\ \frac{0.8\text{V}}{R_{IREF}} \times 10^5 (\text{A}) & R_{IREF} \\ 80\text{mA} & V_{IREF} < 0.4\text{V} \end{cases} \quad (\text{EQ. 5})$$

The internal reference voltage at the IREF pin is capable of sourcing less than $100\mu A$ current. When pulling down the IREF pin with a logic circuit, the logic circuit must be able to sink at least $100\mu A$ current. For design purposes, a designer should assume a tolerance of $\pm 20\%$ when computing the minimum and maximum charge current from [Equation 5](#).

When the adapter is current-limited, it is recommended that the reference current be programmed to at least 30% higher than the adapter current limit (which equals the charge current). In addition, the charge current should be at least 350mA, which the voltage difference between the V_{IN} and the V_{BAT} pins is higher than 100mV. The 100mV is the offset voltage of the input/output voltage comparator shown in “[Block Diagram](#)” on page 2.

End-of-Charge (EOC) Current

The end-of-charge current, I_{EOC} , sets the level at which the charger starts to indicate the end of the charge with the STATUS pin, as shown in [Figure 21 on page 11](#). The charger actually does not terminate charging until the end of the TIMEOUT, as described in ["Total Charge Time" on page 11](#). The I_{EOC} is set to 60mA (typical) internal to the device by tying the I_{EOC} node to V2P8.

Charge Current Thermal Foldback

Overheating is always a concern in a linear charger. The maximum power dissipation usually occurs at the beginning of a charge cycle when the battery voltage is at its minimum, but the charge current is at its maximum. The charge current thermal foldback function in the ISL78693 frees users from the overheating concern.

[Figure 22](#) shows the current signals at the summing node of the current error amplifier in ["Block Diagram" on page 2](#). I_R is the reference and I_T is the current from the temperature monitoring block. The I_T has no impact on the charge current until the internal temperature reaches approximately $+100^\circ\text{C}$ ($+85^\circ\text{C}$ Min) then I_T rises at a rate of $1\mu\text{A}/^\circ\text{C}$. When I_T rises, the current control loop forces the sensed current I_{SEN} to reduce at the same rate. As a mirrored current, the charge current is 100,000 times that of the sensed current and reduces at a rate of $100\text{mA}/^\circ\text{C}$. For a charger with the constant charge current set at 1A, the charge current is reduced to zero when the internal temperature rises to $+110^\circ\text{C}$. The actual charge current settles between $+100^\circ\text{C}$ to $+110^\circ\text{C}$.

The charge current should not drop below I_{EOC} because of the thermal foldback. For some extreme cases (if that does happen), the charger does not indicate end-of-charge unless the battery voltage is already above the recharge threshold.

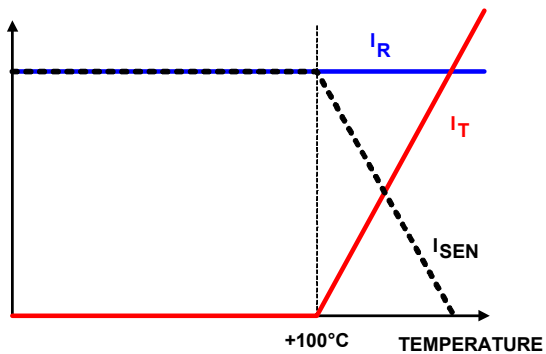

FIGURE 22. CURRENT SIGNALS AT THE AMPLIFIER AC INPUT

2.8V Bias Voltage

The ISL78693 provides a 2.8V voltage for biasing the internal control and logic circuit. This voltage is also available for external circuits such as the NTC thermistor circuit. The maximum allowed external load is 2mA.

NTC Thermistor

The ISL78693 uses two comparators (CP2 and CP3) to form a window comparator, as shown in [Figure 24](#). When the TEMP pin voltage is "out of the window," determined by the V_{TMIN} and V_{TMAX} , the ISL78693 stops charging and indicates a fault condition. When the temperature returns to the set range, the charger restarts a charge cycle. The two MOSFETS, Q1 and Q2, produce hysteresis for both upper and lower thresholds. The temperature window is shown in [Figure 23](#).

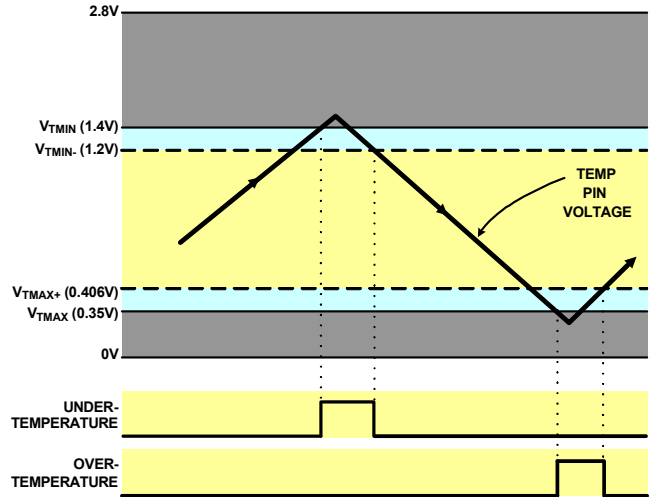

FIGURE 23. CRITICAL VOLTAGE LEVELS FOR TEMP PIN

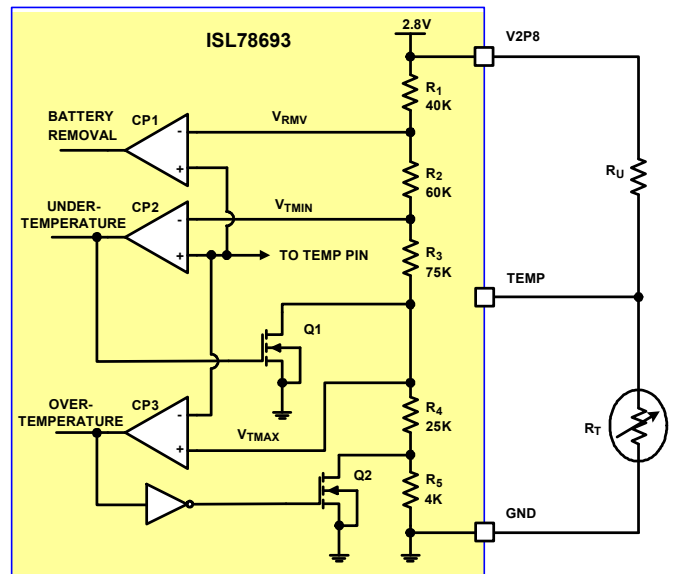

FIGURE 24. THE INTERNAL AND EXTERNAL CIRCUIT FOR THE NTC INTERFACE

As the TEMP pin voltage rises from low and exceeds the 1.4V threshold, the under-temperature signal rises and does not clear until the TEMP pin voltage falls below the 1.2V falling threshold. Similarly, the over-temperature signal is given when the TEMP pin voltage falls below the 0.35V threshold and does not clear until the voltage rises above 0.406V. The actual accuracy of the 2.8V is **not important** because all the thresholds and the TEMP pin voltage are ratios determined by the resistor dividers, as shown in [Figure 24](#).

The NTC thermistor is required to have a resistance ratio of 7:1 at the low and the high temperature limits, that is given by [Equation 6](#):

$$\frac{R_{COLD}}{R_{HOT}} = 7 \tag{EQ. 6}$$

This is because, at the low temperature limit, the TEMP pin voltage is 1.4V, which is 1/2 of the 2.8V bias, as shown in [Equation 7](#):

$$R_{COLD} = R_U \tag{EQ. 7}$$

where R_U is the pull-up resistor as shown in [Figure Figure 24 on page 12](#). At the high temperature limit, the TEMP pin voltage is 0.35V, which is 1/8 of the 2.8V bias, as shown in [Equation 8](#):

$$R_{HOT} = \frac{R_U}{7} \tag{EQ. 8}$$

Various NTC thermistors are available for this application. [Table 2](#) shows the resistance ratio and the negative temperature coefficient of the curve-1 NTC thermistor from [Vishay](#) at various temperatures. The resistance at +3 °C is approximately seven times the resistance at +47 °C, which is shown in [Equation 9](#):

$$\frac{R_{3^{\circ}C}}{R_{47^{\circ}C}} = 7 \tag{EQ. 9}$$

If the low temperature limit is +3 °C, and the high temperature limit is around +47 °C, then the pull-up resistor R_U can be chosen to be the resistance measured at +3 °C.

TABLE 2. RESISTANCE RATIO OF VISHAY'S CURVE-1 NTC

TEMPERATURE (°C)	$R_T/R_{25^{\circ}C}$	NTC (%/°C)
0	3.266	5.1
3	2.806	5.1
5	2.540	5.0
25	1.000	4.4
45	0.4368	4.0
47	0.4041	3.9
50	0.3602	3.9

The temperature hysteresis will now be estimated in the low and high temperatures. At the low temperature, the hysteresis is approximately estimated in [Equation 10](#):

$$T_{hysLOW} \approx \frac{1.4V - 1.2V}{1.4V \cdot 0.051} \approx 3 \text{ (}^{\circ}C) \tag{EQ. 10}$$

where 0.051 is the NTC at +3 °C. Similarly, the high temperature hysteresis is estimated in [Equation 11](#):

$$T_{hysHIGH} \approx \frac{0.406V - 0.35V}{0.35V \cdot 0.039} \approx 4 \text{ (}^{\circ}C) \tag{EQ. 11}$$

where the 0.039 is the NTC at +47 °C.

For applications that do not need to monitor the battery temperature, the NTC thermistor can be replaced with a regular resistor of a half value of the pull-up resistor R_U . Another option is

to connect the TEMP pin to the IREF pin that has a 0.8V output. With such connection, the IREF pin can no longer be programmed with logic inputs. In this condition, no pull-up is allowed for the TEMP pin.

Battery Removal Detection

The ISL78693 assumes that the thermistor is co-packed with the battery and is removed together with the battery. When the charger senses a TEMP pin voltage that is 2.1V or higher, it assumes that the battery is removed. The battery removal detection circuit is also shown in [Figure 24](#). When a battery is removed, a FAULT signal is indicated and charging is halted. When a battery is inserted again, a new charge cycle starts.

Indications

The ISL78693 has three indications: the input presence, the charge status, and the fault indication. The input presence is indicated by the V2P8 pin while the other two indications are presented by the STATUS pin and FAULT pin respectively. [Figure 25](#) shows the V2P8 pin voltage vs the input voltage. [Table 3](#) summarizes the other two pins.

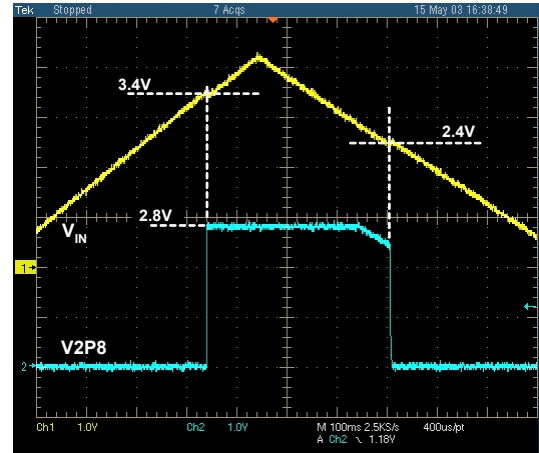

FIGURE 25. THE V2P8 PIN OUTPUT vs THE INPUT VOLTAGE AT THE VIN PIN. VERTICAL: 1V/DIV, HORIZONTAL: 100ms/DIV

TABLE 3. STATUS INDICATIONS

FAULT	STATUS	INDICATION
High	High	Charge completed with no fault (Inhibit) or Standby
High	Low	Charging in one of the three modes
Low	High	Fault

*Both outputs are pulled up with external resistors.

Shutdown

The ISL78693 can be shut down by pulling the EN pin to ground. When shut down, the charger draws typically less than 30µA current from the input power and the 2.8V output at the V2P8 pin is also turned off. The EN pin has to be driven with an open-drain or open-collector logic output. The EN pin is internally biased, so the pin should be floated to turn the device ON once the charger is enabled. To turn OFF the device, an open-drain/open-collector can be used to pull the pin to its low level.

Input and Output Capacitor Selection

The use of a 10 μ F Tantalum type TCA106M016R0200 or Ceramic type C3216X7RC1106KT000N or equivalent is recommended for the input. When used as a charger, the output capacitor should be 2x10 μ F Tantalum type AVX TCJA106M016R0200 or equivalent. The device partially relies on the Equivalent Series Resistance (ESR) of the output capacitor for the loop stability. If there is a need to use ceramic capacitors for device output, it is recommended to use a 220m Ω , 0.25W resistor, in series with the VBAT pin followed by 2x10 μ F, 16V, X7R ceramic capacitor C3216X7RC1106KT000N or equivalent for an $I_{BAT} = 0.5A$ (see [Figure 26](#)).

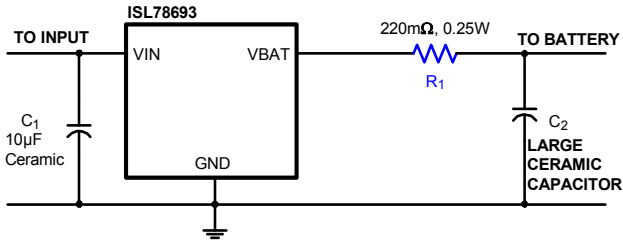

FIGURE 26. INSERTING R_1 TO IMPROVE THE STABILITY OF APPLICATIONS WITH LARGE CERAMIC CAPACITOR USED AT THE OUTPUT

Current-Limited Adapter

[Figure 27](#) shows the ideal current voltage characteristics of a current-limited adapter. The V_{NL} is the no-load adapter output voltage and V_{FL} is the full load voltage at the current limit I_{LIM} . Before its output current reaches the limit I_{LIM} , the adapter presents the characteristics of a voltage source. The slope, r_O , represents the output resistance of the voltage supply. For a well-regulated supply, the output resistance can be very small, but some adapters naturally have a certain amount of output resistance.

The adapter is equivalent to a current source when running in the constant current region. Being a current source, its output voltage is dependent on the load, which in this case, is the charger and the battery. As the battery is being charged, the adapter output rises from a lower voltage in the current voltage characteristics curve, such as point A, to higher voltage until reaching the breaking point B, as shown in [Figure 27](#).

The adapter is equivalent to a voltage source with output resistance when running in the constant voltage region because of this characteristic. As the charge current drops, the adapter output moves from point B to point C, as shown in [Figure 27](#).

The battery pack can be approximated as an ideal cell with a lumped-sum resistance in series, also shown in [Figure 27](#). The ISL78693 charger sits between the adapter and the battery.

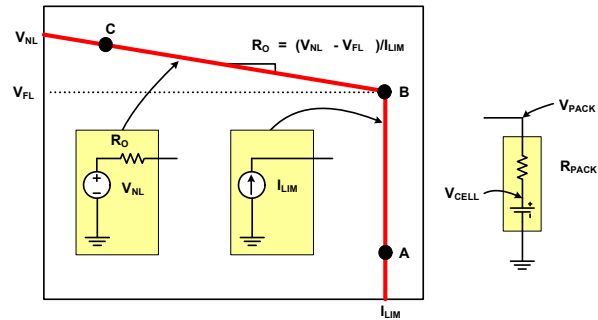

FIGURE 27. THE IDEAL I-V CHARACTERISTICS OF A CURRENT LIMITED POWER SUPPLY

Working with Current-Limited Power Supply

As described earlier, the ISL78693 minimizes the thermal dissipation when running off a current-limited AC adapter, as shown in [Figure 20 on page 10](#). The thermal dissipation can be further reduced when the adapter is properly designed. The following demonstrates that the thermal dissipation can be minimized if the adapter output reaches the full-load output voltage (point B in [Figure 27](#)) before the battery pack voltage reaches the final charge voltage (3.65V). The assumptions for the following discussion are: the adapter current limit = 500mA, the battery pack equivalent resistance = 200m Ω , and the charger ON-resistance is 350m Ω .

When charging in the constant current region, the pass element in the charger is fully turned on. The charger is equivalent to the ON-resistance of the internal P-Channel MOSFET. The entire charging system is equivalent to the circuit shown in [Figure 28A on page 15](#). The charge current is the constant current limit, I_{LIM} , and the adapter output voltage can be easily found out as calculated in [Equation 12](#):

$$V_{Adapter} = I_{LIM} \cdot r_{DS(ON)} + V_{PACK} \quad (EQ. 12)$$

where V_{PACK} is the battery pack voltage. The power dissipation in the charger is given in [Equation 2](#), where $I_{CHARGE} = I_{LIM}$.

A critical condition of the adapter design is that the adapter output reaches point B in [Figure 27](#) at the same time as the battery pack voltage reaches the final charge voltage (3.65V), as shown in [Equation 13](#):

$$V_{Critical} = I_{LIM} \cdot r_{DS(ON)} + V_{CH} \quad (EQ. 13)$$

For example, if the final charge voltage is 3.65V, the $r_{DS(ON)}$ is 350m Ω , and the current limit, I_{LIM} , is 500mA, the critical adapter full-load voltage is 3.825V.

When the above condition is true, the charger enters the Constant Voltage mode simultaneously as the adapter exits the Current Limit mode. The equivalent charging system is shown in [Figure 28C on page 15](#). Since the charge current drops at a higher rate in the Constant Voltage mode than the increase rate of the adapter voltage, the power dissipation decreases as the charge current decreases. Therefore, the worst case thermal dissipation occurs in the constant current charge mode. [Figure 29A](#) shows the I-V curves of the adapter output, the battery pack voltage, and the cell voltage during the charge. The 5.9V no-load voltage is just an example value higher than the

full-load voltage. The cell voltage 3.65V uses the assumption that the pack resistance is 200mΩ. [Figure 29A](#) illustrates the adapter voltage, battery pack voltage, the charge current, and the power dissipation in the charger respectively in the time domain.

If the battery pack voltage reaches 3.65V before the adapter reaches point B in [Figure 27](#), a voltage step is expected at the adapter output when the pack voltage reaches the final charge voltage. As a result, the charger power dissipation is also expected to have a step rise. This case is shown in [Figure 20 on page 10](#) as well as [Figure 30C](#). Under this condition, the worst case thermal dissipation in the charger happens when the charger enters the constant voltage mode.

If the adapter voltage reaches the full-load voltage before the pack voltage reaches 3.65V, the charger will experience the resistance-limit situation. In this situation, the ON-resistance of the charger is in series with the adapter output resistance. The equivalent circuit for the resistance-limit region is shown in [Figure 28B](#). Eventually, the battery pack voltage will reach 3.65V because the adapter no-load voltage is higher than 3.65V, then [Figure 28C](#) becomes the equivalent circuit until charging ends. In this case, the worst-case thermal dissipation also occurs in the constant current charge mode. [Figure 29B](#) shows the I-V curves of the adapter output, the battery pack voltage, and the cell voltage for the case VFL = 3.55V. In this case, the full-load voltage is lower than the final charge voltage (3.65V), but the charger is still

able to fully charge the battery as long as the no-load voltage is above 3.65V. [Figure 29B](#) illustrates the adapter voltage, battery pack voltage, the charge current, and the power dissipation in the charger respectively in the time domain.

Based on the previous discussion, the worst-case power dissipation occurs during the constant current charge mode if the adapter full-load voltage is lower than the critical voltage given in [Equation 13](#). Even if that is not true, the power dissipation is still much less than the power dissipation in the traditional linear charger. [Figures 27](#) and [28](#) are scope-captured waveforms to demonstrate the operation with a current-limited adapter.

The waveforms in [Figure 27](#) are the adapter output voltage (1V/div), the battery voltage (1V/div), and the charge current (200mA/div) respectively. The time scale is 1ks/div. The adapter current is limited to 600mA and the charge current is programmed to 1A. Note that the voltage difference is only approximately 200mV and the adapter voltage tracks the battery voltage in the CC mode. [Figure 27](#) also shows the resistance limit mode before entering the CV mode.

[Figure 28](#) shows the actual captured waveforms depicted in [Figure 30C](#). The constant charge current is 750mA. A step in the adapter voltage during the transition from CC mode to CV mode is demonstrated.

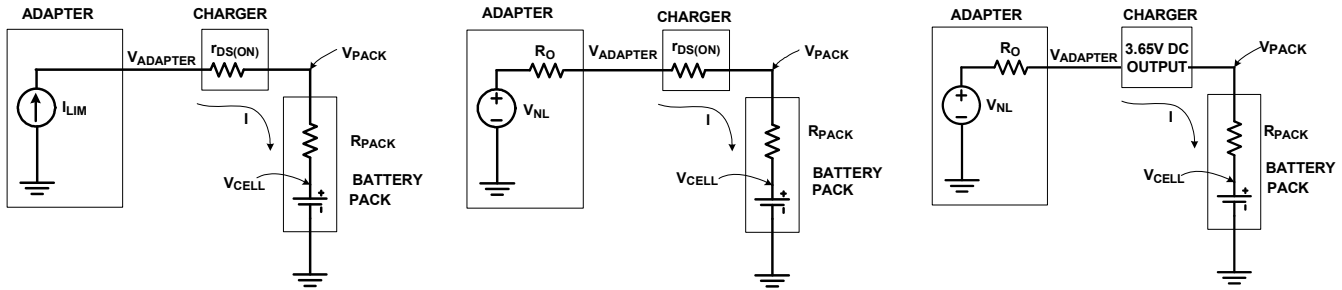

FIGURE 28A. THE EQUIVALENT CIRCUIT IN THE CONSTANT CURRENT REGION

FIGURE 28B. THE EQUIVALENT CIRCUIT IN THE RESISTANCE-LIMIT REGION

FIGURE 28C. THE EQUIVALENT CIRCUIT WHEN THE PACK VOLTAGE REACHES THE FINAL CHARGE VOLTAGE

FIGURE 28. THE EQUIVALENT CIRCUIT OF THE CHARGING SYSTEM WORKING WITH CURRENT-LIMITED ADAPTERS

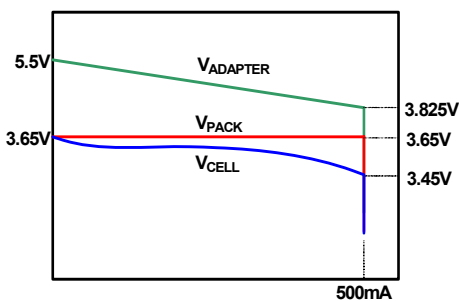

FIGURE 29A.

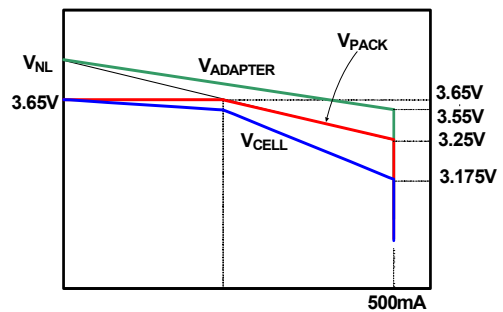

FIGURE 29B.

FIGURE 29. THE I-V CHARACTERISTICS OF THE CHARGER WITH DIFFERENT CURRENT LIMITED POWER SUPPLIES

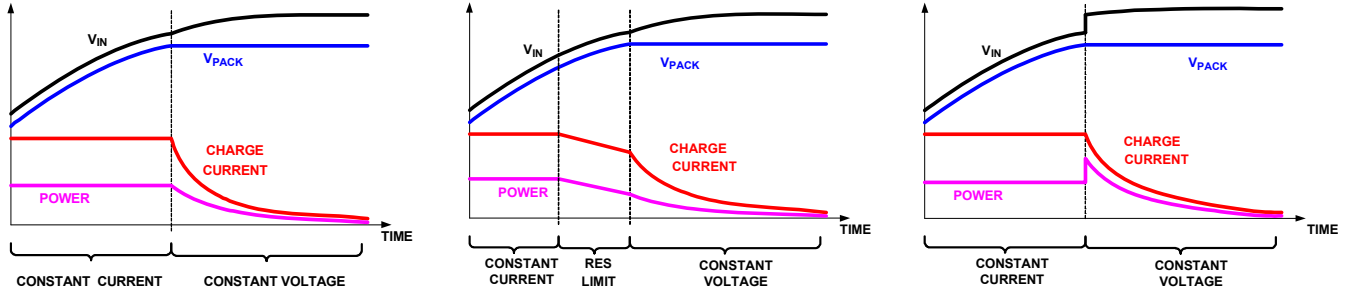

FIGURE 30A. FIGURE 30B. FIGURE 30C.
FIGURE 30. THE OPERATING CURVES WITH THREE DIFFERENT CURRENT-LIMITED POWER SUPPLIES

IREF Programming Using Current-Limited Adapter

The ISL78693 has 20% tolerance for the charge current. Typically, the current-limited adapter also has 10% tolerance. In order to guarantee proper operation, it is recommended that the nominal charge current be programmed **at least 30% higher** than the nominal current limit of the adapter.

Board Layout Recommendations

The ISL78693 internal thermal foldback function limits the charge current when the internal temperature reaches approximately +100°C. In order to maximize the current capability, it is very important that the exposed pad under the package is properly soldered to the board and is connected to other layers through thermal vias. More thermal vias and more copper attached to the exposed pad usually result in better thermal performance. On the other hand, the number of vias is limited by the size of the pad. The 3x3 DFN package allows nine vias to be placed in three rows. Since the pins on the 3x3 DFN package are on only two sides, as much top layer copper as possible should be connected to the exposed pad to minimize the thermal impedance. Refer to [UG098](#), "ISL78693EVAL1Z Evaluation Board User Guide" for layout example.

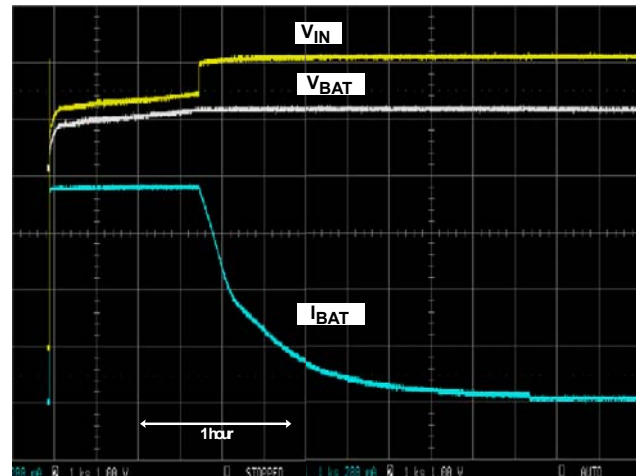

FIGURE 32. SCOPE WAVEFORMS SHOWING THE FULL-LOAD POWER SUPPLY VOLTAGE AS HIGHER THAN THE CRITICAL VOLTAGE

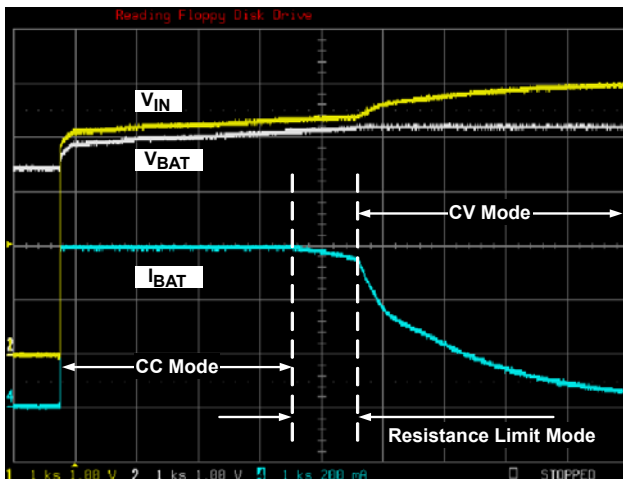

FIGURE 31. SCOPE WAVEFORMS SHOWING THE THREE MODES

Revision History The revision history provided is for informational purposes only and is believed to be accurate, but not warranted. Please visit our website to make sure you have the latest revision.

DATE	REVISION	CHANGE
December 12, 2016	FN8891.1	Changed title on page 1 from "Li-ion/Li-Polymer Battery Charger" to "Automotive Single-Cell LiFePO4 Battery Charger".
October 31, 2016	FN8891.0	Initial Release.

About Intersil

Intersil Corporation is a leading provider of innovative power management and precision analog solutions. The company's products address some of the largest markets within the industrial and infrastructure, mobile computing, and high-end consumer markets.

For the most updated datasheet, application notes, related documentation, and related parts, see the respective product information page found at www.intersil.com.

You may report errors or suggestions for improving this datasheet by visiting www.intersil.com/ask.

Reliability reports are also available from our website at www.intersil.com/support.

© Copyright Intersil Americas LLC 2016. All Rights Reserved.

All trademarks and registered trademarks are the property of their respective owners.

For additional products, see www.intersil.com/en/products.html

Intersil Automotive Qualified products are manufactured, assembled and tested utilizing TS16949 quality systems as noted in the quality certifications found at www.intersil.com/en/support/qualandreliability.html

Intersil products are sold by description only. Intersil may modify the circuit design and/or specifications of products at any time without notice, provided that such modification does not, in Intersil's sole judgment, affect the form, fit or function of the product. Accordingly, the reader is cautioned to verify that datasheets are current before placing orders. Information furnished by Intersil is believed to be accurate and reliable. However, no responsibility is assumed by Intersil or its subsidiaries for its use; nor for any infringements of patents or other rights of third parties which may result from its use. No license is granted by implication or otherwise under any patent or patent rights of Intersil or its subsidiaries.

For information regarding Intersil Corporation and its products, see www.intersil.com