

ISL8002-19EVAL1Z

1.5A/2A Low Quiescent Current High Efficiency Synchronous Buck Regulator

AN1803
Rev 0.00
Dec 13, 2012

Description

The ISL8002, ISL8002A and ISL80019, ISL80019A kits are intended for use by individuals with requirements for point-of-load applications sourcing from 2.7V to 5.5V. The ISL8002, ISL8002A and ISL80019, ISL80019A evaluation boards are used to demonstrate the performance of the ISL8002 and ISL80019, low quiescent current high efficiency synchronous buck regulator.

The ISL8002, ISL8002A and ISL80019, ISL80019A are offered in a 2mmx2mm 8 Ld μ TDFN package with 1mm maximum height. The complete area that the converter occupies can be as small as 0.10in².

TABLE 1. SUMMARY OF KEY DIFFERENCES

PART NUMBER	I _{OUT} (Max) (A)	F _{SW} RANGE (MHz)	V _{IN} RANGE (V)	V _{OUT} RANGE (V)	PART SIZE (mm sq.)
ISL80019	1.5	1	2.7 to 5.5	0.6 to 5.5	2x2
ISL80019A	1.5	2			
ISL8002	2	1			
ISL8002A	2	2			

Quick Setup Guide

1. Ensure that the circuit is correctly connected to the supply and loads prior to applying any power.
2. Connect the bias supply to VIN, the plus terminal to VIN (P4) and the negative return to PGND (P5).
3. Connect the output load to V0, the plus terminal to V0 (P7) and the negative return to PGND (P8).
4. Verify that the position is PWM or PFM for SW2.
5. Verify that the position is ON for SW1.
6. Turn on the power supply.
7. Verify the output voltage is 1.8V for V0.

Recommended Equipment

The following materials are recommended to perform testing:

- 0V to 10V power supply with at least 10A source current capability or 5V battery
- Electronic loads capable of sinking current up to 7A
- Digital multimeters (DMMs)
- 100MHz quad-trace oscilloscope
- Signal generator

Key Features

- High efficiency synchronous buck regulator with up to 95% efficiency
- 0.8% reference accuracy over-temperature/load/line
- Start-up with pre-biased output
- Internal soft-start - 1ms
- Soft-stop output discharge during disable
- 1MHz, 2MHz default frequency
- Negative OC protection

Evaluating the Other Output Voltage

The ISL8002, ISL8002A and ISL80019, ISL80019A kits outputs are preset to 1.8V for V0, however, the output voltages can be adjusted from 0.6V to 5V. The output voltage programming resistor, R₁, will depend on the desired output voltage of the regulator. The value for the feedback resistor is typically between 0 Ω and 200k Ω , as shown in Equation 1.

$$R_1 = R_2 \left(\frac{V_0}{V_{FB}} - 1 \right) \quad (\text{EQ. 1})$$

If the output voltage desired is 0.6V, then R₂ is left unpopulated and R₁ is shorted. For faster response performance, add 10pF to 47pF in parallel to R₁. Check bode plot to insure optimum performance.

Switch Control

The ISL8002, ISL8002A and ISL80019, ISL80019A evaluation board contains SW1 and SW2 for various controls of the ISL8002, ISL8002A and ISL80019, ISL80019A circuitries. Table 2 details this function.

TABLE 2. SWITCH SETTINGS

SW1	ENABLE	FUNCTION
1	OFF	Disable V0
3	ON	Enable V0
SW2	MODE	FUNCTION
1	PFM	Force continuous mode
3	PWM	Fixed PWM frequency at light load

ISL8002, ISL8002A, ISL80019, ISL80019EVAL1Z Schematic

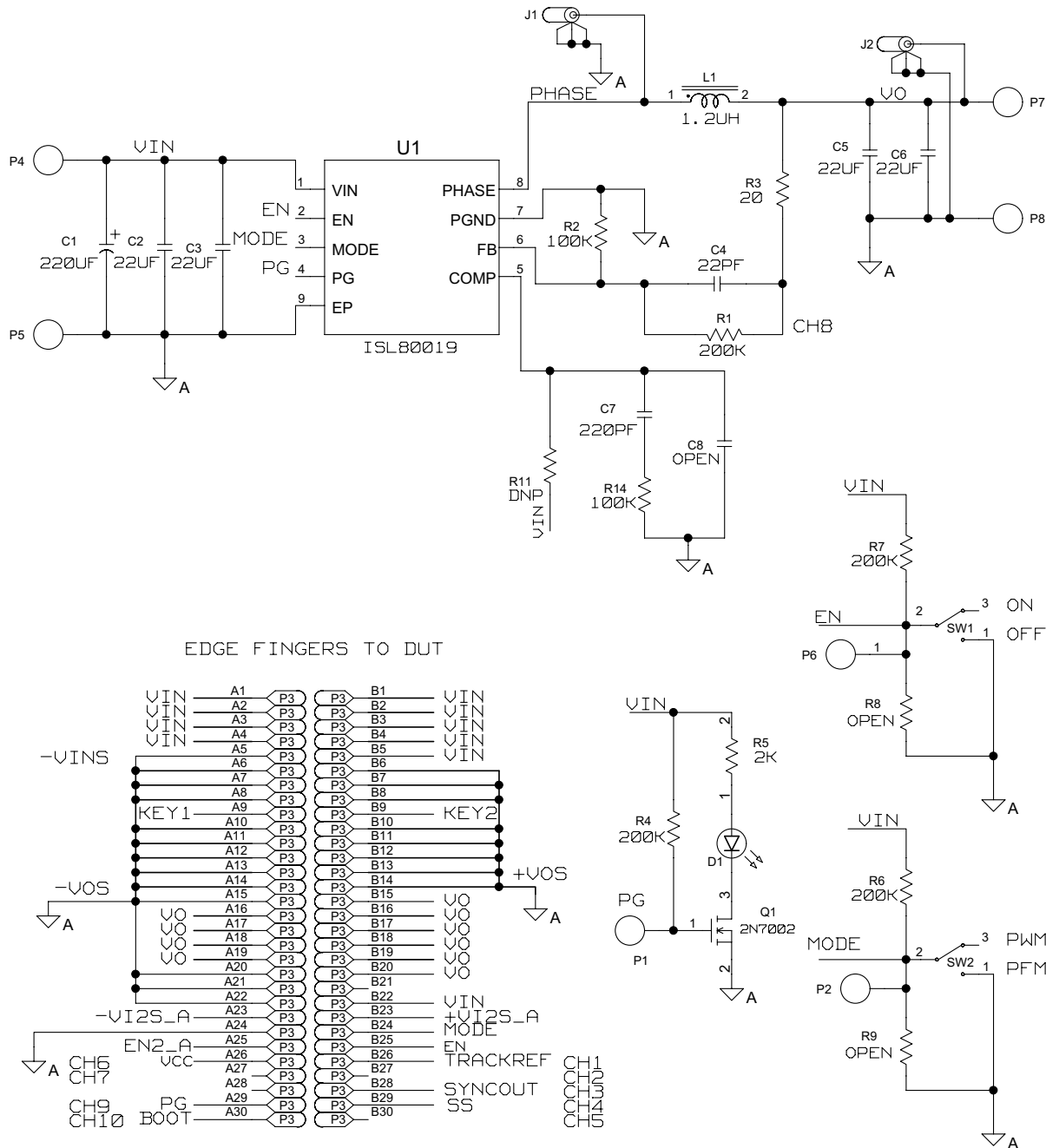

TABLE 3. BILL OF MATERIALS

PART NUMBER	QTY	UNITS	REFERENCE DESIGNATOR	DESCRIPTION	MANUFACTURER	MANUFACTURER PART
10TPB220M	1	ea	C1	CAP-POSCAP, SMD, D4, 220µF, 10V, 20%, ROHS	SANYO	10TPB220M
H1045-00220-50V5-T	1	ea	C4	CAP, SMD, 0603, 22pF, 50V, 5%, COG, ROHS	VENKEL, KEMET, TDK MURATA, ROHM	C0603C0G500-220JNE, C0603C220J5GACTU, C1608C0G1H220J, GRM1885C1H220JA01D, MCH185A220JK
H1045-00221-50V10-T	1	ea	C7	CAP, SMD, 0603, 220pF, 50V, 10%, X7R, ROHS	MURATA, VENKEL, AVX, TDK, YAGEO, ROHM, KEMET	GRM188R71H221KA01D, C0603X7R500-221KNE, 06035C221KAT2A, C1608X7R1H221K, MCH185CN221KK, CC0603KRX7R9BB221, C0603C221K5RACTU
H1045-DNP	0	ea	C8	CAP, SMD, 0603, DNP-PLACE HOLDER, ROHS		
H1065-00226-6R3V20-T	4	ea	C2, C3, C5, C6	CAP, SMD, 1206, 22µF, 6.3V, 20%, X5R, ROHS	PANASONIC, TAIYO YUDEN, TDK, AVX	ECJ-DV50J226M, JMK316BJ226ML, C3216X5R0J226M, 12066D226MAT2A
VLCF-4028T-1R2N2R7-2	1	ea	L1 for ISL8002A, ISL80019A, 2MHz	COIL-PWR INDUCTOR, WW, SMD, 4mm, 1.2µH, 30%, 2.7A, ROHS	TDK	VLCF4028T-1R2N2R7-2
74437324022	1	ea	L1 for ISL8002, ISL80019, 1MHz	COIL-PWR INDUCTOR, SMD, 4.45x4.6, 2.2µH, 20%, 3.25A, ROHS	Würth Electronics	74437324022
LTST-C170CKT	1	ea	D1	LED-GaAs RED, SMD, 2x1.25mm, 100mW, 40mA, 10mcd, ROHS	LITEON/VISHAY, ROHM, STANLEY ELECTRIC	LTST-C170CKT, SML-210LTT86, BR112H-TR
ISL8002AIRZ	1	ea	U1	IC-2A BUCK REGULATOR, 8P, µTDFN, 2x2, ROHS	INTERSIL	ISL8002AIRZ
2N7002-7-F-T	1	ea	Q1	TRANSISTOR, N-CHANNEL, 3 LD, SOT-23, 60V, 115mA, ROHS	DIODES, INC., ON SEMICONDUCTOR	2N7002-7-F, 2N7002LT1G
H2511-00200-1/10W1-T	1	ea	R3	RES, SMD, 0603, 20Ω, 1/10W, 1%, TF, ROHS	PANASONIC, YAGEO, VENKEL	ERJ-3EKF20R0V, RC0603FR-0720RL, CR0603-10W-20R0FT
H2511-01003-1/10W1-T	2	ea	R2, R14	RES, SMD, 0603, 100k, 1/10W, 1%, TF, ROHS	VENKEL, PANASONIC, ROHM, YAGEO, STACKPOLE, VISHAY/DALE	CR0603-10W-1003FT, ERJ-3EKF1003V, MCR03EZPF1003, RC0603FR-07100KL, RMCF 1/16 100K 1% R, CRCW0603100KFKEA
H2511-02001-1/10W1-T	1	ea	R5	RES, SMD, 0603, 2k, 1/10W, 1%, TF, ROHS	KOA, VENKEL	RK73H1JTTD2001F, CR0603-10W-2001FT

TABLE 3. BILL OF MATERIALS (Continued)

PART NUMBER	QTY	UNITS	REFERENCE DESIGNATOR	DESCRIPTION	MANUFACTURER	MANUFACTURER PART
H2511-02003-1/10W1-T	4	ea	R1, R4, R6, R7	RES, SMD, 0603, 200k, 1/10W, 1%, TF, ROHS	VENKEL, YAGEO, VISHAY/DALE, PANASONIC, ROHM	CR0603-10W-2003FT, RC0603FR-07200KL, CRCW0603200KFKEA, ERJ-3EKF2003V, MCR03EZPF2003
H2511-DNP	0	ea	R8, R9, R11	RES, SMD, 0603, DNP-PLACE HOLDER, ROHS		
GT11MSCBE-T	2	ea	SW1, SW2	SWITCH-TOGGLE, SMD, 6 PIN, SPDT, 2 POS, ON-ON, ROHS	ITT INDUSTRIES/C&K DIVISION	GT11MSCBE

ISL8002, ISL8002A, ISL80019, ISL80019AEVAL1Z Layout

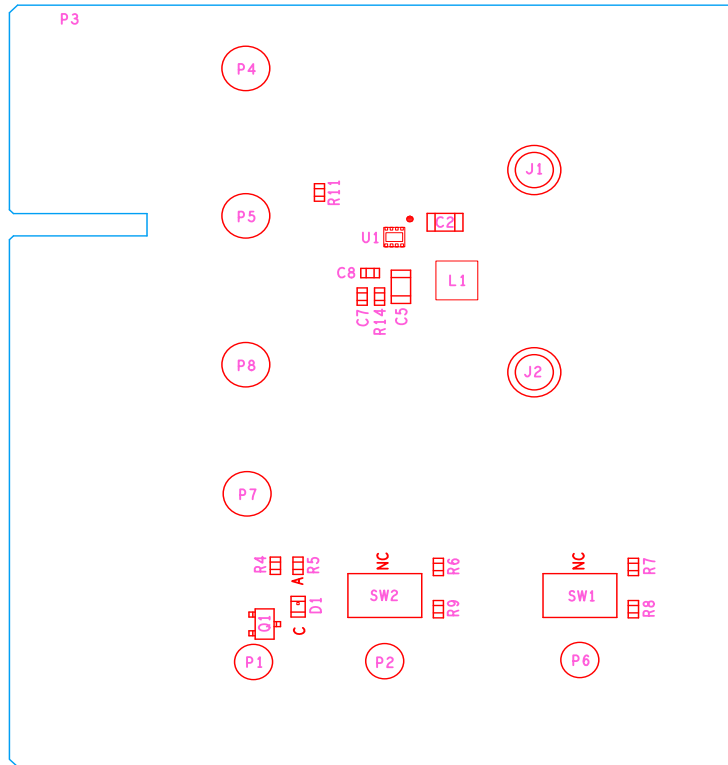

FIGURE 1. TOP LAYER COMPONENTS

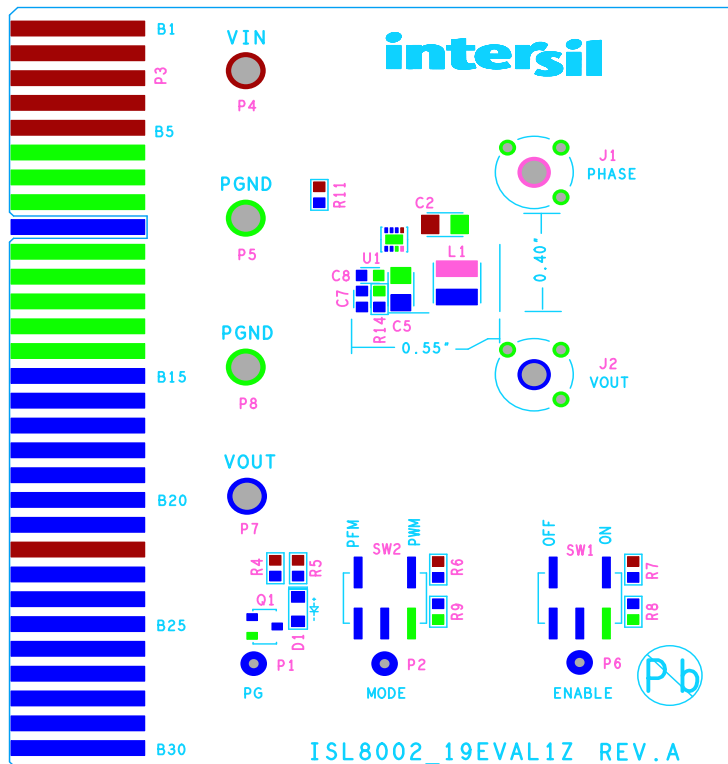

FIGURE 2. SILKSCREEN TOP

ISL8002, ISL8002A, ISL80019, ISL80019AEVAL1Z Layout (Continued)

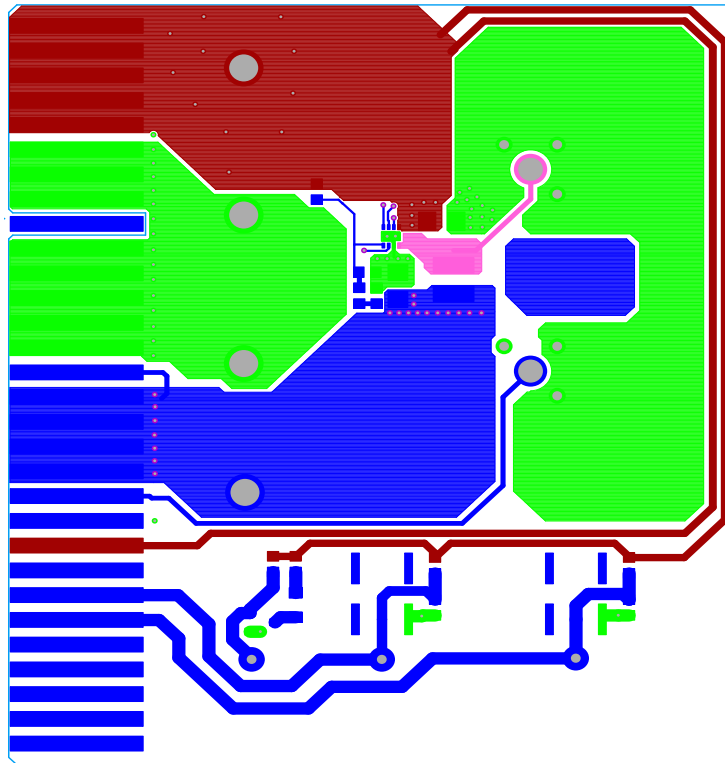

FIGURE 3. TOP LAYER ETCH

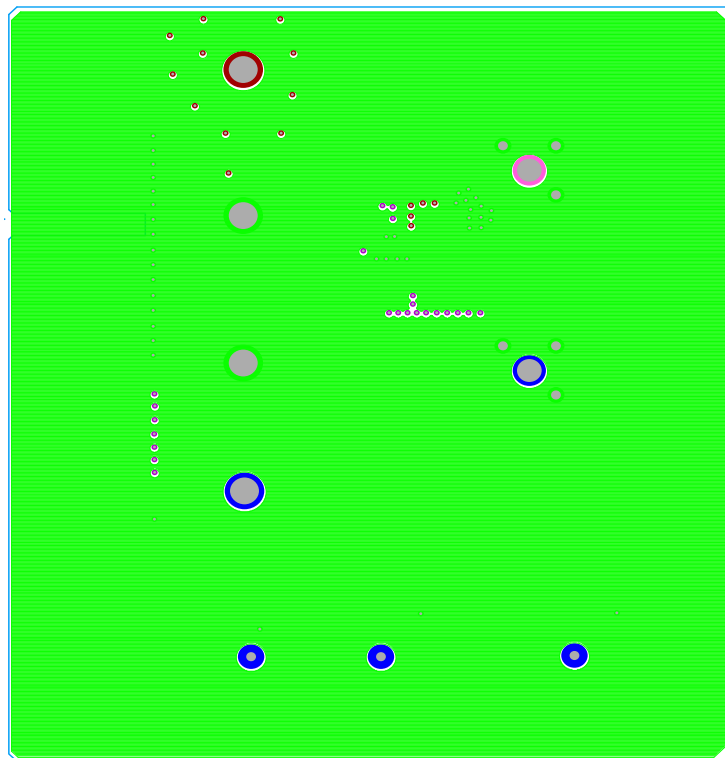

FIGURE 4. SECOND LAYER ETCH

ISL8002, ISL8002A, ISL80019, ISL80019AEVAL1Z Layout (Continued)

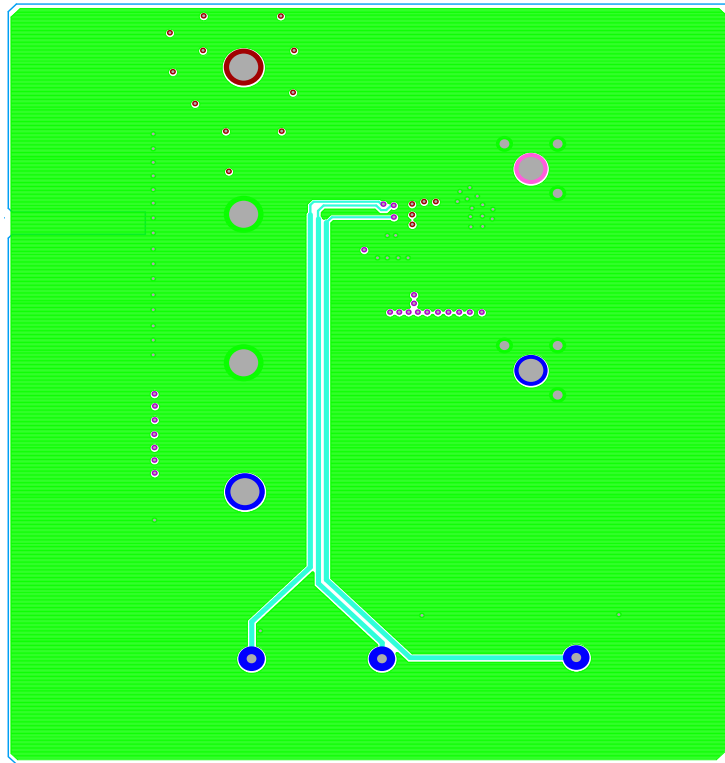

FIGURE 5. THIRD LAYER ETCH

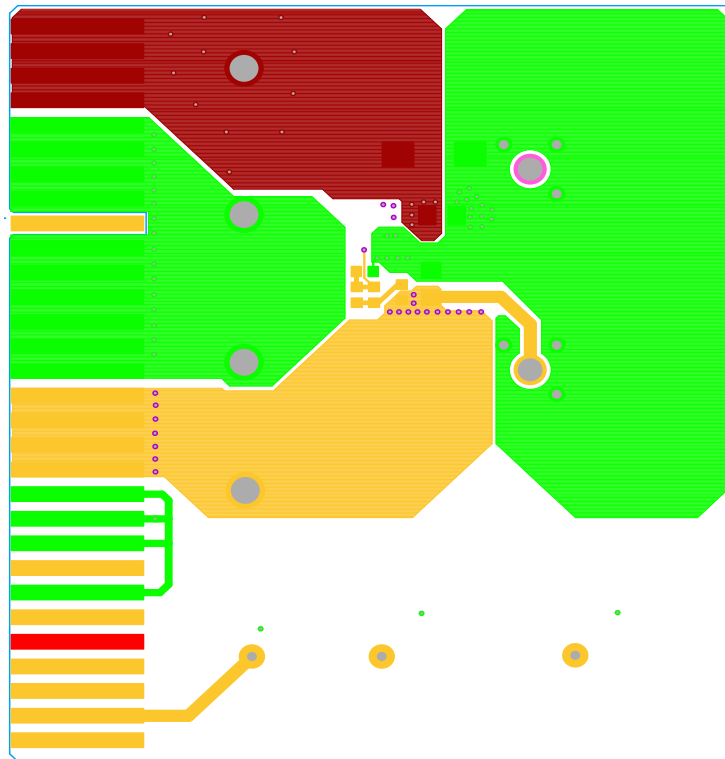

FIGURE 6. BOTTOM LAYER ETCH

ISL8002, ISL8002A, ISL80019, ISL80019AEVAL1Z Layout (Continued)

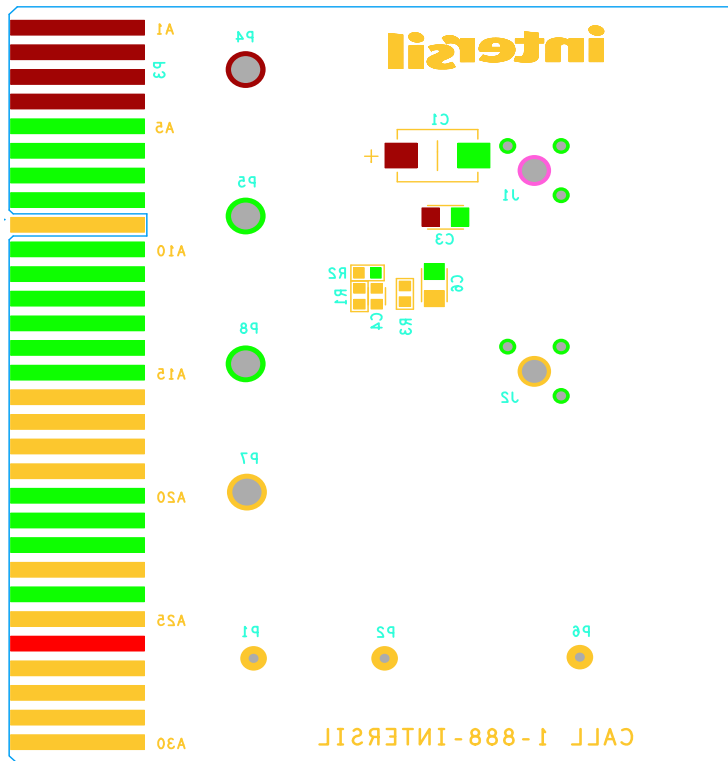

FIGURE 7. BOTTOM LAYER COMPONENTS