

ISL8016

6A Low Quiescent Current High Efficiency Synchronous Buck Regulator

FN7616  
Rev 1.00  
May 5, 2011

The ISL8016 is a high efficiency, monolithic, synchronous step-down DC/DC converter that can deliver up to 6A continuous output current from a 2.7V to 5.5V input supply. The output voltage is adjustable from 0.6V to  $V_{IN}$ . With an adjustable current limit, reverse current protection, pre-bias start and over temperature protection the ISL8016 offers a highly robust power solution. It uses current control architecture to deliver fast transient response and excellent loop stability.

The ISL8016 integrates a pair of low ON-resistance P-Channel and N-Channel internal MOSFETs to maximize efficiency and minimize external component count. 100% duty-cycle operation allows less than 200mV dropout at 6A output current. Adjustable frequency and synchronization allow the ISL8016 to be used in applications requiring low noise. Paralleling capability with phase interleaving allows the IC to support >6A output current while offering reduced input and output noise.

The ISL8016 can be configured for discontinuous or forced continuous operation at light load. Forced continuous operation reduces noise and RF interference while discontinuous mode provides high efficiency by reducing switching losses at light loads.

The ISL8016 is offered in a space saving 20 Ld 3x4 QFN lead free package with exposed pad lead frames for excellent thermal performance. The complete converter occupies less than 0.15in<sup>2</sup> area.

Various fixed output voltages are available upon request. See Ordering Information on page 2 for more detail.

**Features**

- High Efficiency Synchronous Buck Regulator with up to 97% Efficiency
- 1% Reference Accuracy Over-Temperature/Load/Line
- Fixed Output Voltage Option
- ±10% Output Voltage Margining
- Adjustable Current Limit
- Current Sharing Capable
- Start-up with Pre-Biased Output
- Internal Soft-Start - 1ms or Adjustable, Internal/External Compensation
- Soft-Stop Output Discharge During Disabled
- Adjustable Frequency from 500kHz to 4MHz - Default at 1MHz
- External Synchronization up to 4MHz - Master to Slave Phase Shifting Capability
- Peak current limiting, Hiccup Mode Short Circuit Protection and Over-Temperature Protection'

**Applications**

- DC/DC POL Modules
- $\mu$ C/ $\mu$ P, FPGA and DSP Power
- Plug-in DC/DC Modules for Routers and Switchers
- Portable Instruments
- Test and Measurement Systems
- Li-ion Battery Powered Devices

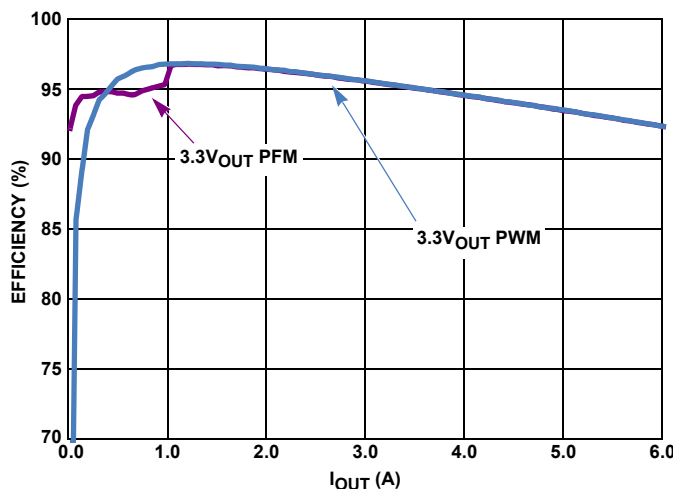

FIGURE 1. EFFICIENCY T = +25°C V<sub>IN</sub> = 5V

## Ordering Information

PART NUMBER (Notes 1, 2, 3)	PART MARKING	OUTPUT VOLTAGE (V)	TEMP. RANGE (°C)	PACKAGE (Pb-Free)	PKG. DWG. #
ISL8016IRAJZ	016A	Adjustable	-40 to +85	20 Ld 3x4 QFN	L20.3x4
ISL8016IR12Z	016W	1.2V	-40 to +85	20 Ld 3x4 QFN	L20.3x4
ISL8016IR15Z	016B	1.5V	-40 to +85	20 Ld 3x4 QFN	L20.3x4
ISL8016IR18Z	016C	1.8V	-40 to +85	20 Ld 3x4 QFN	L20.3x4
ISL8016IR25Z	016F	2.5V	-40 to +85	20 Ld 3x4 QFN	L20.3x4
ISL8016IR33Z	016N	3.3V	-40 to +85	20 Ld 3x4 QFN	L20.3x4

### NOTES:

1. Add "-T\*" suffix for tape and reel. Please refer to [TB347](#) for details on reel specifications.
2. These Intersil Pb-free plastic packaged products employ special Pb-free material sets, molding compounds/die attach materials, and 100% matte tin plate plus anneal (e3 termination finish, which is RoHS compliant and compatible with both SnPb and Pb-free soldering operations). Intersil Pb-free products are MSL classified at Pb-free peak reflow temperatures that meet or exceed the Pb-free requirements of IPC/JEDEC J STD-020.
3. For Moisture Sensitivity Level (MSL), please see device information page for [ISL8016](#). For more information on MSL please see techbrief [TB363](#).

## Pin Configuration

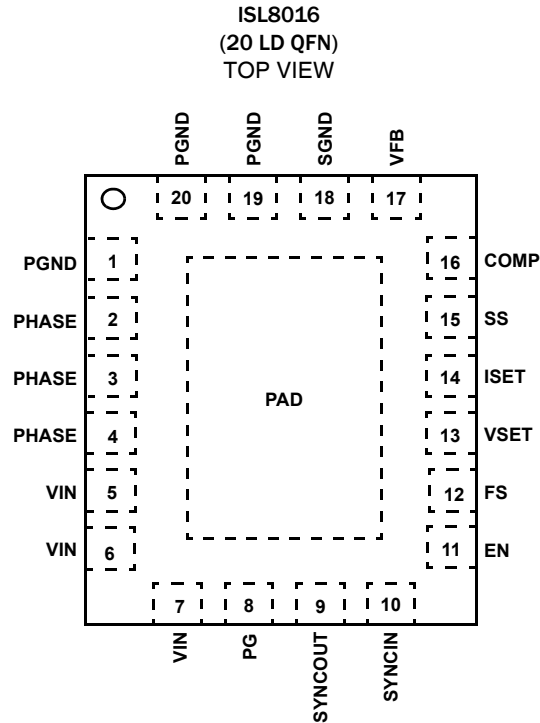

## Pin Descriptions

PIN	SYMBOL	DESCRIPTION
1, 19, 20	PGND	Power ground.
2, 3, 4	PHASE	Switching node connection. Connect to one terminal of the inductor.
5, 6, 7	VIN	Input supply voltage. Connect two 22 $\mu$ F ceramic capacitors to power ground.
8	PG	Power-good is an open-drain output. Use 10k $\Omega$ to 100k $\Omega$ pull-up resistor connected between VIN and PG. At power-up or EN HI, PG rising edge is delayed by 1ms from the output reaching regulation.
9	SYNCOUT	This pin outputs a 250 $\mu$ A current source that is turned on at the rising edge of the internal clock or SYNCIN. When SYNCOUT voltage reaches 1V, a reset circuit will activate and discharge SYNCOUT to 0V. SYNCOUT is held at 0V in PFM light load to reduce quiescent current.
10	SYNCIN	Mode Selection pin. Connect to logic high or input voltage VIN for PWM mode. Connect to logic low or ground for PFM mode. Connect to an external function generator for synchronization with the positive edge trigger. There is an internal 1M $\Omega$ pull-down resistor to prevent an undefined logic state if SYNCIN is floating.
11	EN	Regulator enable pin. Enables the output when driven to high. Shuts down the chip and discharges the output capacitor when driven to low. There is an internal 1M $\Omega$ pull-down resistor to prevent an undefined logic state in case of EN pin float.
12	FS	This pin sets the oscillator switching frequency, using a resistor, R <sub>FS</sub> , from the FS pin to GND. The frequency of operation may be programmed between 500kHz to 4MHz. The default frequency is 1MHz and configured for internal compensation if FS is connected to VIN.
13	VSET	VSET is the output margining setting of the regulators. Connect to SGND for -10%, keep it floating for no margining, and connect to VIN for +10%.
14	ISET	ISET is the peak output current limit and SKIP current limit setting of the regulators. Connect to SGND for 2A, to VIN for 4A, and keep it floating for 6A.
15	SS	SS is used to adjust the soft-start time. Set to SGND for internal 1ms rise time. Connect a capacitor from SS to SGND to adjust the soft-start time. Do not use more than 33nF per IC.
16, 17	COMP, VFB	The feedback network of the regulator, VFB, is the negative input to the transconductance error amplifier. COMP is the output of the amplifier if the FS resistor is used. If internal compensation is used (FS = VIN), the comp pin should be tied to SGND. The output voltage is set by an external resistor divider connected to VFB. With a properly selected divider, the output voltage can be set to any voltage between VIN and the 0.6V reference. While internal compensation offers a solution for many typical applications, an external compensation network may offer improved performance for some designs. In addition to regulation, VFB is also used to determine the state of PG. Short VFB to OUTPUT when using one of the available fixed VOUT options.
18	SGND	Signal ground.
	EPAD	The exposed pad must be connected to the SGND pin for proper electrical performance. Place as many vias as possible under the pad connecting to the system GND plane for optimal thermal performance.

## Typical Application Diagrams

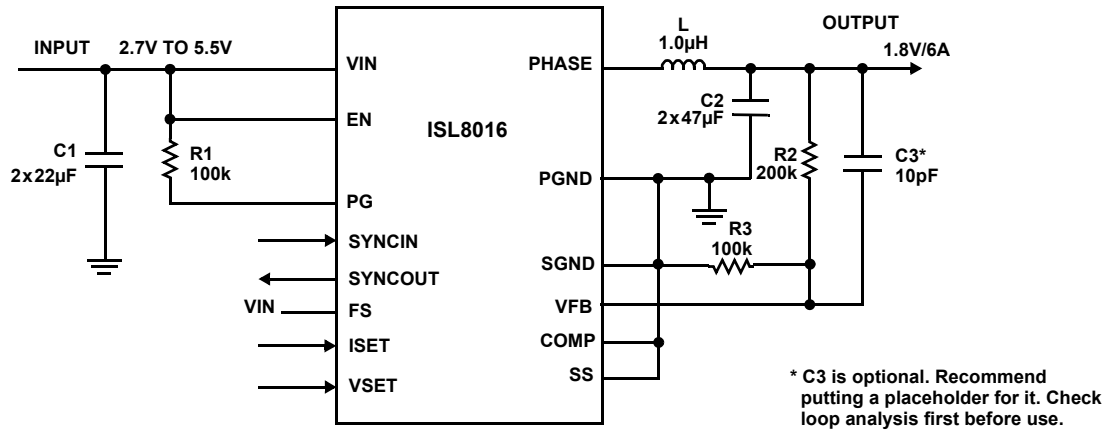

FIGURE 2. TYPICAL APPLICATION DIAGRAM - SINGLE CHIP 6A

TABLE 1. COMPONENT VALUE SELECTION

V <sub>OUT</sub>	0.8V	1.2V	1.5V	1.8V	2.5V	3.3V	3.6V
C1	44µF	44µF	44µF	44µF	44µF	44µF	44µF
C2 (or C8)	2x47µF	2x47µF	2x47µF	2x47µF	2x47µF	2x47µF	2x47µF
C3 (or C5)	10pF	10pF	10pF	10pF	10pF	10pF	10pF
L1 (or L2)	0.47~1µH	0.47~1µH	0.47~1µH	0.68~1.5µH	0.68~1.5µH	1~2.2µH	1~2.2µH
R2 (or R5)	33k	100k	150k	200k	316k	450k	500k
R3 (or R6)	100k	100k	100k	100k	100k	100k	100k

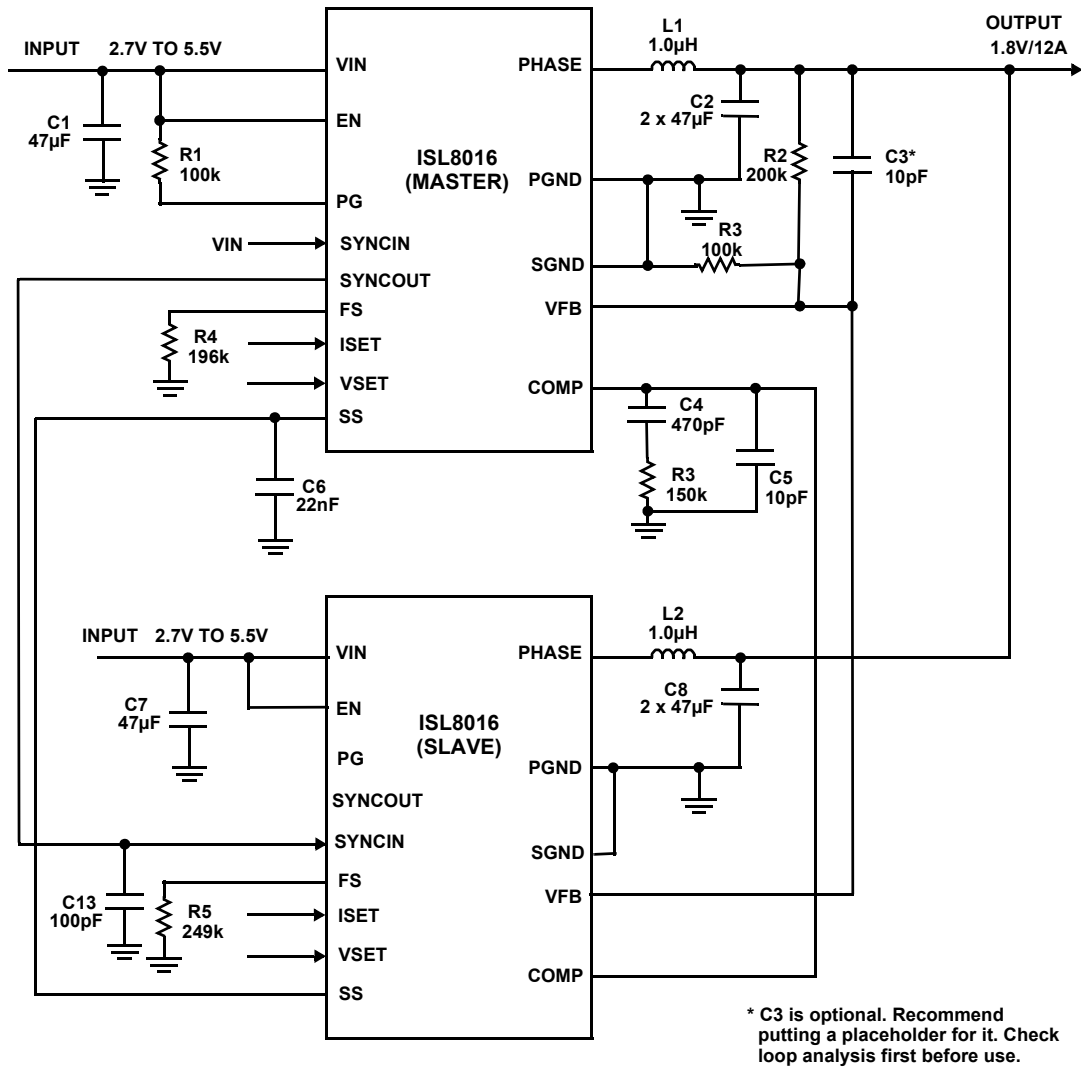

FIGURE 3. TYPICAL APPLICATION DIAGRAM - MULTI CHIP CONFIGURATION 12A

# Block Diagram

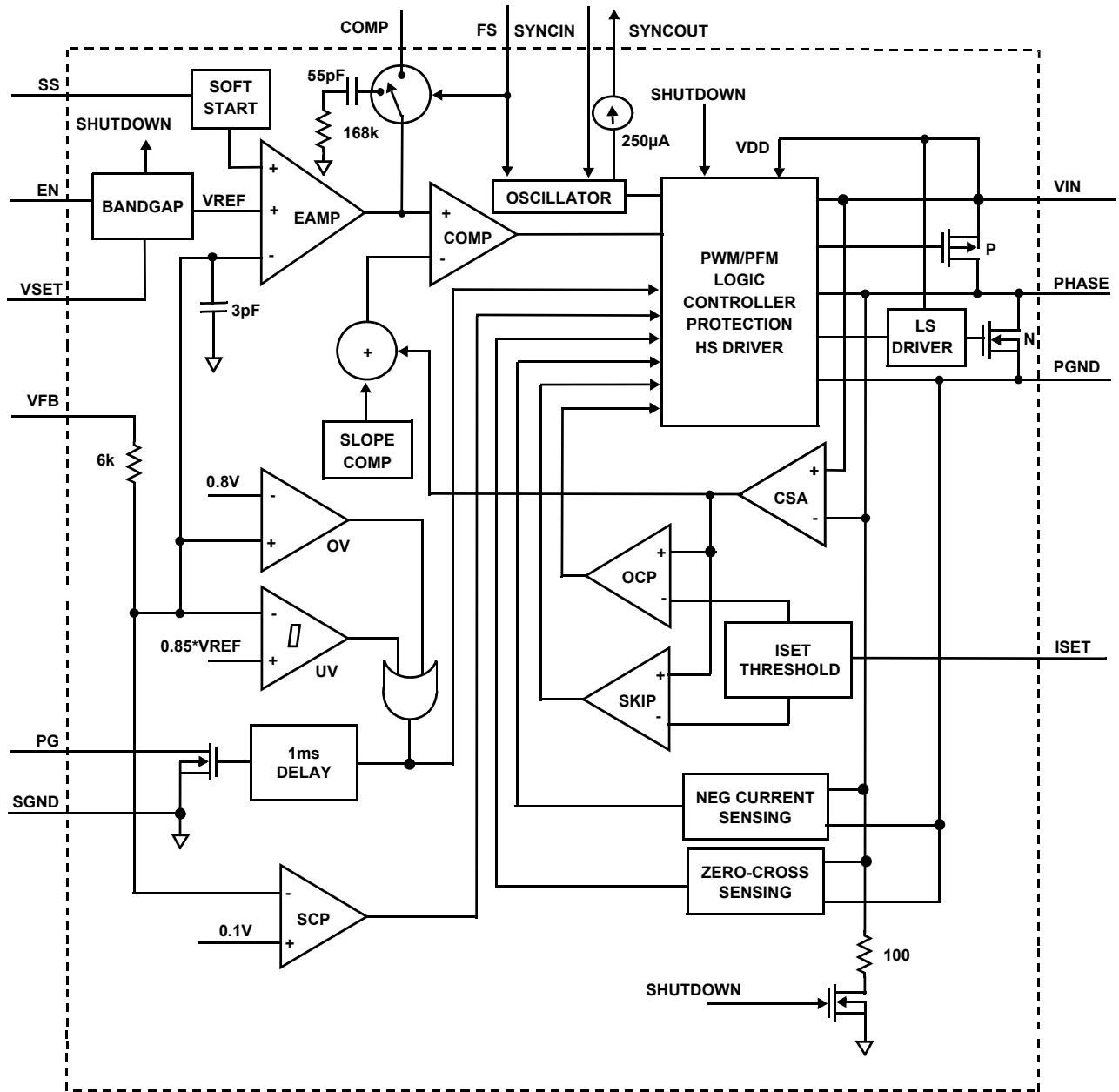

FIGURE 4. FUNCTIONAL BLOCK DIAGRAM

**Absolute Maximum Ratings** (Reference to GND)

VIN	-0.3V to 5.8V (DC) or 7V (20ms)
EN, FS, ISET, PG, SYNCOUT, SYNCIN VFB, VSET	-0.3V to VIN+0.3V
PHASE	-1.5V (100ns)/-0.3V (DC) to 6.5V (DC) or 7V (20ms)
COMP, SS	-0.3V to 2.7V
ESD Rating	
Human Body Model (Tested per JESD22-A114)	3kV
Machine Model (Tested per JESD22-A115)	300V
Charged Device Model (Tested per JESD22-C101E)	1500V
Latch Up (Tested per JESD-78A; Class 2, Level A)	.100mA @ +85°C

**Thermal Information**

Thermal Resistance (Typical)	$\theta_{JA}$ (°C/W)	$\theta_{JC}$ (°C/W)
3x4 QFN Package (Notes 4, 5)	42	5
Junction Temperature Range	-55°C to +125°C	
Storage Temperature Range	-65°C to +150°C	
Pb-Free Reflow Profile	see link below <a href="http://www.intersil.com/pbfree/Pb-FreeReflow.asp">http://www.intersil.com/pbfree/Pb-FreeReflow.asp</a>	

**Recommended Operating Conditions**

VIN Supply Voltage Range	2.7V to 5.5V
Load Current Range	0A to 6A
Ambient Temperature Range	-40°C to +85°C

**CAUTION:** Do not operate at or near the maximum ratings listed for extended periods of time. Exposure to such conditions may adversely impact product reliability and result in failures not covered by warranty.

**NOTES:**

- $\theta_{JA}$  is measured in free air with the component mounted on a high effective thermal conductivity test board with "direct attach" features. See Tech Brief TB379.
- $\theta_{JC}$ , "case temperature" location is at the center of the exposed metal pad on the package underside.

**Analog Specifications** Unless otherwise noted, all parameter limits are established over the recommended operating conditions and the typical specification are measured at the following conditions:  $T_A = -40^\circ\text{C}$  to  $+85^\circ\text{C}$ ,  $V_{IN} = 3.6\text{V}$ ,  $EN = V_{IN}$ , unless otherwise noted. Typical values are at  $T_A = +25^\circ\text{C}$ . **Boldface limits apply over the operating temperature range,  $-40^\circ\text{C}$  to  $+85^\circ\text{C}$ .**

PARAMETER	SYMBOL	TEST CONDITIONS	MIN (Note 6)	TYP	MAX (Note 6)	UNITS
<b>INPUT SUPPLY</b>						
VIN Undervoltage Lockout Threshold	V <sub>UVLO</sub>	Rising, no load		2.5	<b>2.7</b>	V
		Falling, no load	<b>2.2</b>	2.4		V
Quiescent Supply Current	I <sub>VIN</sub>	SYNCIN = GND, no load at the output		70		μA
		SYNCIN = GND, no load at the output and no switches switching		70	<b>90</b>	μA
		SYNCIN = VIN, F <sub>S</sub> = 1MHz, no load at the output		8	<b>15</b>	mA
Shut Down Supply Current	I <sub>SD</sub>	SYNCIN = GND, V <sub>IN</sub> = 5.5V, EN = low		5	<b>7</b>	μA
<b>OUTPUT REGULATION</b>						
Reference Voltage - ISL8016IRAJZ	V <sub>REF</sub>	V <sub>SET</sub> = V <sub>IN</sub>	<b>0.651</b>	0.660	<b>0.669</b>	V
		V <sub>SET</sub> = FLOAT	<b>0.594</b>	0.600	<b>0.606</b>	V
		V <sub>SET</sub> = SGND	<b>0.531</b>	0.540	<b>0.549</b>	V
Output Voltage - ISL8016IR12Z	V <sub>VFB</sub>	V <sub>SET</sub> = FLOAT	<b>1.188</b>	1.200	<b>1.212</b>	V
Output Voltage - ISL8016IR15Z	V <sub>VFB</sub>	V <sub>SET</sub> = FLOAT	<b>1.485</b>	1.500	<b>1.515</b>	V
Output Voltage - ISL8016IR18Z	V <sub>VFB</sub>	V <sub>SET</sub> = FLOAT	<b>1.782</b>	1.800	<b>1.818</b>	V
Output Voltage - ISL8016IR25Z	V <sub>VFB</sub>	V <sub>SET</sub> = FLOAT	<b>2.475</b>	2.500	<b>2.525</b>	V
Output Voltage - ISL8016IR33Z	V <sub>VFB</sub>	V <sub>SET</sub> = FLOAT	<b>3.266</b>	3.300	<b>3.333</b>	V
Output Voltage Margining	V <sub>VFB</sub>	V <sub>SET</sub> = V <sub>IN</sub> , Percent of OUTPUT changed	<b>9.5</b>	10	<b>10.5</b>	%
		V <sub>SET</sub> = SGND, Percent of OUTPUT changed	<b>-10.5</b>	-10	<b>-9.5</b>	%
VFB Bias Current - ISL8016IRAJZ	I <sub>VFB</sub>	VFB = 0.75V		0.1		μA
Fixed Output VFB Bias Current - ISL8016IRXXZ	I <sub>VFB</sub>	V <sub>SET</sub> = FLOAT, VFB = 10% above OUTPUT		6		μA
Line Regulation		V <sub>IN</sub> = V <sub>O</sub> + 0.5V to 5.5V (minimal 2.7V)		0.2		%/V
Soft-Start Ramp Time Cycle		SS = SGND		1		ms
Soft-Start Charging Current	I <sub>SS</sub>	V <sub>SS</sub> = 0.1V	<b>1.4</b>	1.8	<b>2.2</b>	μA

**Analog Specifications** Unless otherwise noted, all parameter limits are established over the recommended operating conditions and the typical specification are measured at the following conditions:  $T_A = -40^\circ\text{C}$  to  $+85^\circ\text{C}$ ,  $V_{IN} = 3.6\text{V}$ ,  $EN = V_{IN}$ , unless otherwise noted. Typical values are at  $T_A = +25^\circ\text{C}$ . **Boldface limits apply over the operating temperature range,  $-40^\circ\text{C}$  to  $+85^\circ\text{C}$ . (Continued)**

PARAMETER	SYMBOL	TEST CONDITIONS	MIN (Note 6)	TYP	MAX (Note 6)	UNITS
<b>OVERCURRENT PROTECTION</b>						
Current Limit Blanking Time	$t_{OCON}$			17		Clock pulses
Overcurrent and Auto Restart Period	$t_{OCCOFF}$			8		SS cycle
Positive Peak Current Limit	$I_{PLIMIT}$	$I_{SET} = \text{FLOAT}$	<b>7.7</b>	9.5	<b>11.5</b>	A
		$I_{SET} = V_{IN}$	<b>5.5</b>	6.5	<b>8.0</b>	A
		$I_{SET} = \text{SGND}$	<b>3</b>	4.0	<b>5</b>	A
Peak Skip Limit	$I_{SKIP}$	$I_{SET} = \text{FLOAT}$	<b>1.6</b>	2	<b>2.4</b>	A
		$I_{SET} = V_{IN}$	<b>1.0</b>	1.35	<b>1.6</b>	A
		$I_{SET} = \text{SGND}$		0.85		A
Zero Cross Threshold			<b>-300</b>		<b>300</b>	mA
Negative Current Limit	$I_{NLIMIT}$		<b>-4.25</b>	-3	<b>-1.75</b>	A
<b>COMPENSATION</b>						
Error Amplifier Trans-Conductance		$FS = V_{IN}$		100		$\mu\text{A}/\text{V}$
		FS with Resistor		200		$\mu\text{A}/\text{V}$
Trans-Resistance	RT		<b>0.117</b>	0.138	<b>0.16</b>	$\Omega$
<b>PHASE</b>						
P-Channel MOSFET ON-Resistance		$V_{IN} = 5\text{V}$ , $I_O = 200\text{mA}$		31	<b>45</b>	$\text{m}\Omega$
		$V_{IN} = 2.7\text{V}$ , $I_O = 200\text{mA}$		44	<b>55</b>	$\text{m}\Omega$
N-Channel MOSFET ON-Resistance		$V_{IN} = 5\text{V}$ , $I_O = 200\text{mA}$		19	<b>35</b>	$\text{m}\Omega$
		$V_{IN} = 2.7\text{V}$ , $I_O = 200\text{mA}$		25	<b>50</b>	$\text{m}\Omega$
PHASE Maximum Duty Cycle				100		%
PHASE Minimum On-Time		SYNCIN = High			<b>140</b>	ns
<b>OSCILLATOR</b>						
Nominal Switching Frequency	Fsw	$FS = V_{IN}$	<b>800</b>	1000	<b>1200</b>	kHz
		FS with RS = 402k $\Omega$	<b>450</b>	525	<b>600</b>	kHz
		FS with RS = 42.4k $\Omega$	<b>3300</b>	3900	<b>4500</b>	kHz
SYNCIN Logic Low to High Transition Range			<b>0.70</b>	0.75	<b>0.80</b>	V
SYNCIN Hysteresis				0.15		V
SYNCIN Logic Input Leakage Current		$V_{IN} = 3.6\text{V}$		3.6	<b>5</b>	$\mu\text{A}$
SYNCOUT Charging Current	$I_{SO}$	PWM	<b>210</b>	250	<b>290</b>	$\mu\text{A}$
		PFM		0		$\mu\text{A}$
SYNCOUT Voltage Low					<b>0.3</b>	V
<b>PG</b>						
Output Low Voltage					<b>0.3</b>	V
Delay Time (Rising Edge)			<b>0.5</b>	1	<b>2</b>	ms
PG Pin Leakage Current				0.01	<b>0.1</b>	$\mu\text{A}$
OVP PG Rising Threshold				0.80		V
UVP PG Rising Threshold			<b>80</b>	85	<b>90</b>	%



**Analog Specifications** Unless otherwise noted, all parameter limits are established over the recommended operating conditions and the typical specification are measured at the following conditions:  $T_A = -40^\circ\text{C}$  to  $+85^\circ\text{C}$ ,  $V_{IN} = 3.6\text{V}$ ,  $EN = V_{IN}$ , unless otherwise noted. Typical values are at  $T_A = +25^\circ\text{C}$ . **Boldface limits apply over the operating temperature range,  $-40^\circ\text{C}$  to  $+85^\circ\text{C}$ . (Continued)**

PARAMETER	SYMBOL	TEST CONDITIONS	MIN (Note 6)	TYP	MAX (Note 6)	UNITS
UVP PG Hysteresis				5		%
PGOOD Delay Time (Falling Edge)				7		$\mu\text{s}$
<b>ISET, VSET</b>						
Logic Input Low					<b>0.4</b>	V
Logic Input Float			<b>0.5</b>		<b>0.8</b>	V
Logic Input High			<b>0.9</b>			V
Logic Input Leakage Current				0.1	<b>1</b>	$\mu\text{A}$
<b>EN</b>						
Logic Input Low					<b>0.4</b>	V
Logic Input High			<b>0.9</b>			V
EN Logic Input Leakage Current				0.1	<b>1</b>	$\mu\text{A}$
Thermal Shutdown				150		$^\circ\text{C}$
Thermal Shutdown Hysteresis				25		$^\circ\text{C}$

## NOTE:

6. Compliance to datasheet limits is assured by one or more methods: production test, characterization and/or design.

## Typical Operating Performance

Unless otherwise noted, operating conditions are:  $T_A = +25^\circ\text{C}$ ,  $V_{IN} = 5\text{V}$ ,  $EN = 3.3\text{V}$ ,  $SYNCIN = V_{IN}$ ,  $L = 1.0\mu\text{H}$ ,  $C_1 = 2 \times 22\mu\text{F}$ ,  $C_2 = 4 \times 22\mu\text{F}$ ,  $V_{OUT} = 1.8\text{V}$ ,  $I_{OUT} = 0\text{A to } 6\text{A}$ .

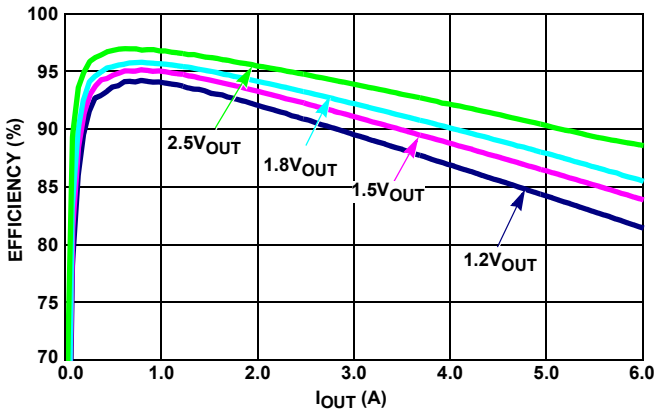

FIGURE 5. EFFICIENCY vs LOAD (1MHz 3.3VIN PWM)

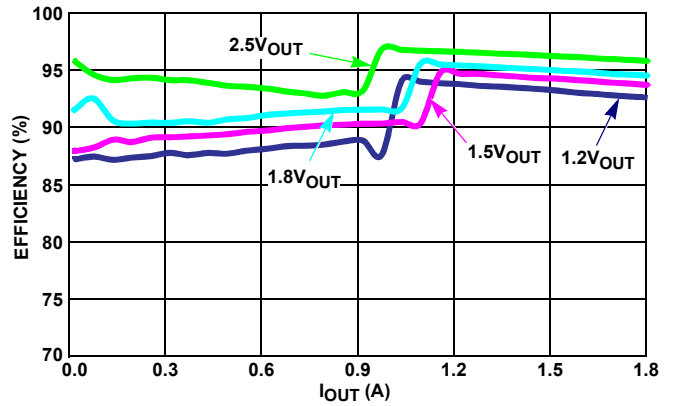

FIGURE 6. EFFICIENCY vs LOAD (1MHz 3.3VIN PFM)

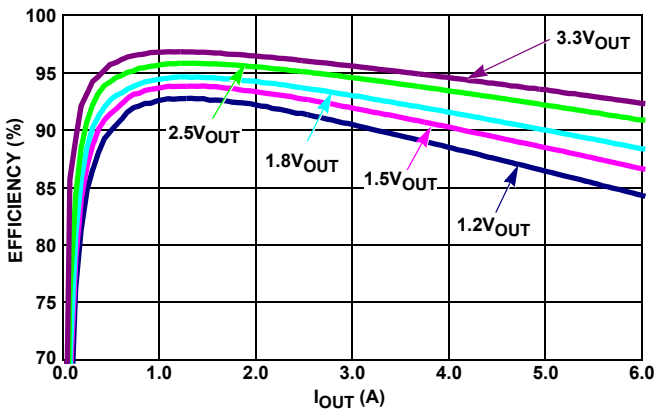

FIGURE 7. EFFICIENCY vs LOAD (1MHz 5VIN PWM)

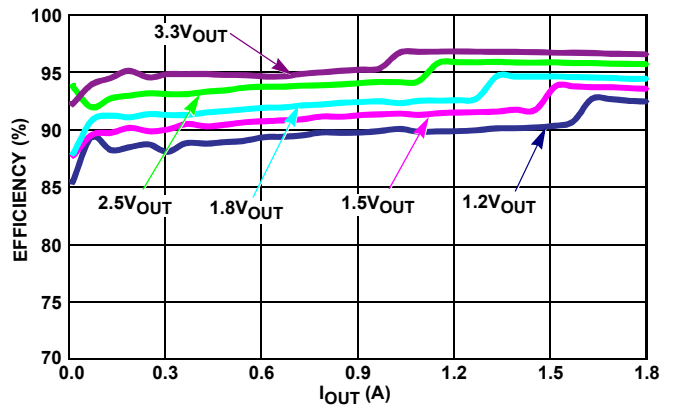

FIGURE 8. EFFICIENCY vs LOAD (1MHz 5VIN PFM)

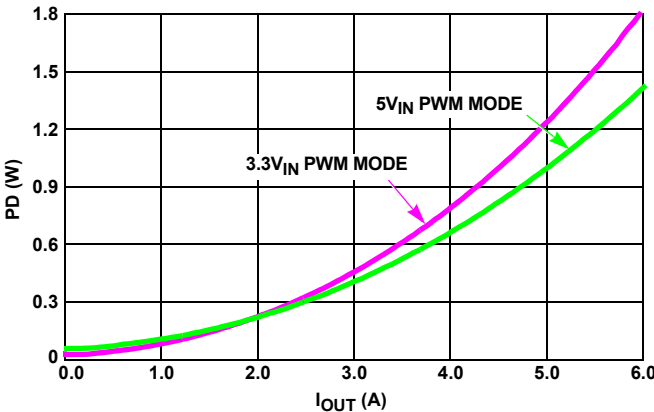

FIGURE 9. POWER DISSIPATION vs LOAD (1MHz,  $V_{OUT} = 1.8\text{V}$ )

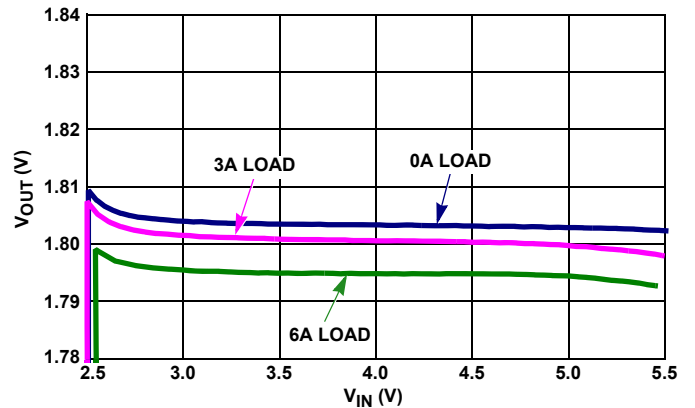

FIGURE 10.  $V_{OUT}$  REGULATION vs  $V_{IN}$  (PWM  $V_{OUT} = 1.8\text{V}$ )

## Typical Operating Performance

Unless otherwise noted, operating conditions are:  $T_A = +25^\circ\text{C}$ ,  $V_{IN} = 5\text{V}$ ,  $EN = 3.3\text{V}$ ,  $SYNCIN = V_{IN}$ ,  $L = 1.0\mu\text{H}$ ,  $C_1 = 2 \times 22\mu\text{F}$ ,  $C_2 = 4 \times 22\mu\text{F}$ ,  $V_{OUT} = 1.8\text{V}$ ,  $I_{OUT} = 0\text{A to } 6\text{A}$ . (Continued)

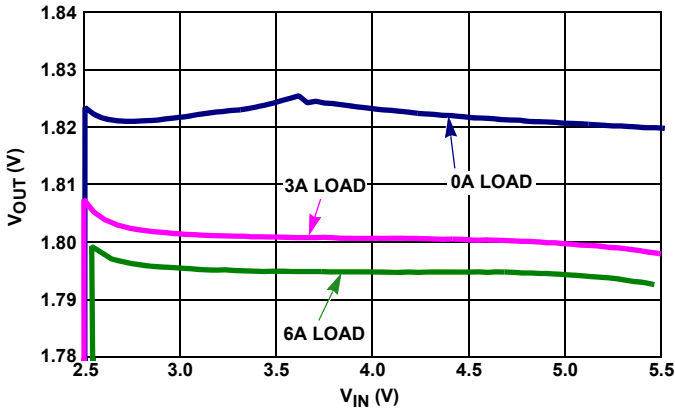

FIGURE 11.  $V_{OUT}$  REGULATION vs  $V_{IN}$  (PFM  $V_{OUT} = 1.8\text{V}$ )

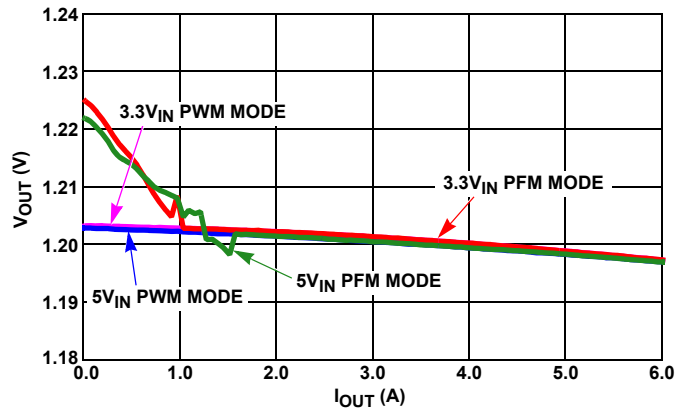

FIGURE 12.  $V_{OUT}$  REGULATION vs LOAD (1MHz,  $V_{OUT} = 1.2\text{V}$ )

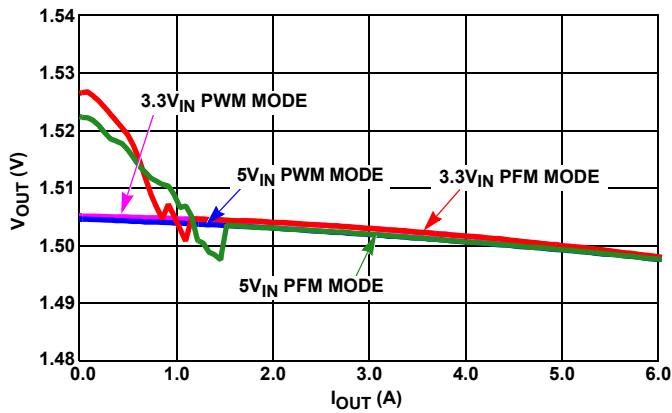

FIGURE 13.  $V_{OUT}$  REGULATION vs LOAD (1MHz,  $V_{OUT} = 1.5\text{V}$ )

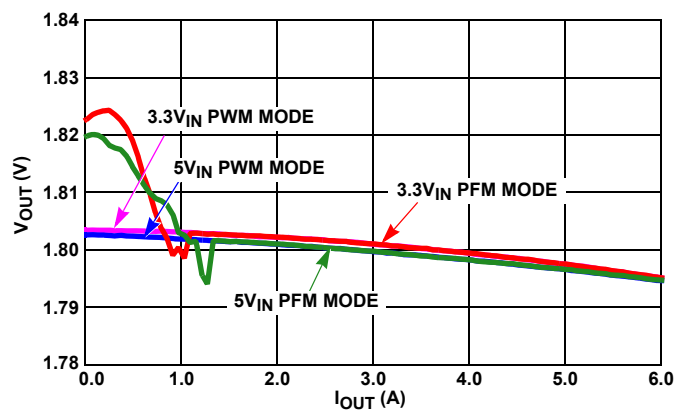

FIGURE 14.  $V_{OUT}$  REGULATION vs LOAD (1MHz,  $V_{OUT} = 1.8\text{V}$ )

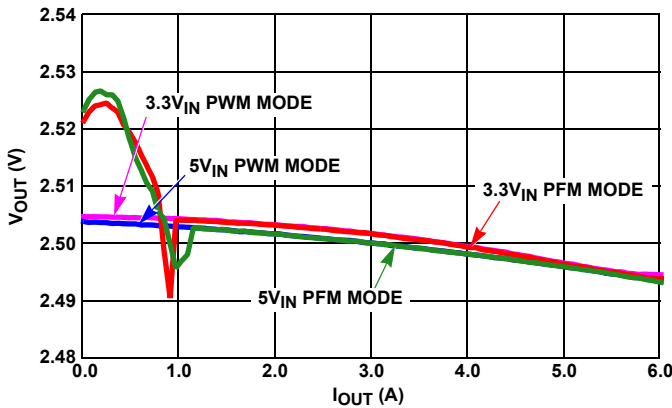

FIGURE 15.  $V_{OUT}$  REGULATION vs LOAD (1MHz,  $V_{OUT} = 2.5\text{V}$ )

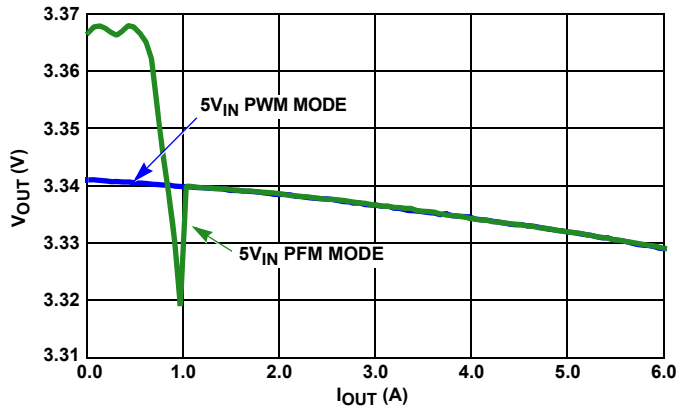

FIGURE 16.  $V_{OUT}$  REGULATION vs LOAD (1MHz,  $V_{OUT} = 3.3\text{V}$ )

# Typical Operating Performance

Unless otherwise noted, operating conditions are:  $T_A = +25^\circ\text{C}$ ,  $V_{IN} = 5\text{V}$ ,  $EN = 3.3\text{V}$ ,  $SYNCIN = V_{IN}$ ,  $L = 1.0\mu\text{H}$ ,  $C_1 = 2 \times 22\mu\text{F}$ ,  $C_2 = 4 \times 22\mu\text{F}$ ,  $V_{OUT} = 1.8\text{V}$ ,  $I_{OUT} = 0\text{A}$  to  $6\text{A}$ . (Continued)

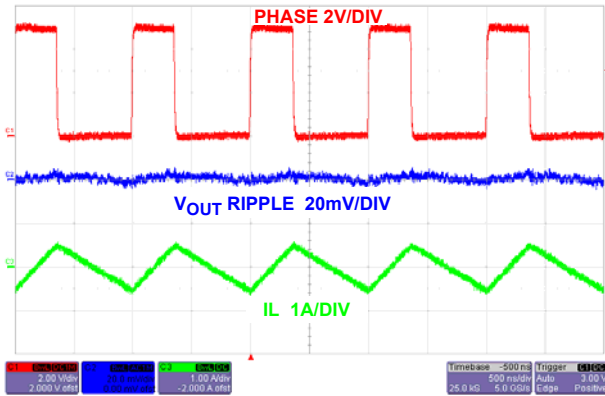

FIGURE 17. STEADY STATE OPERATION AT NO LOAD (PWM)

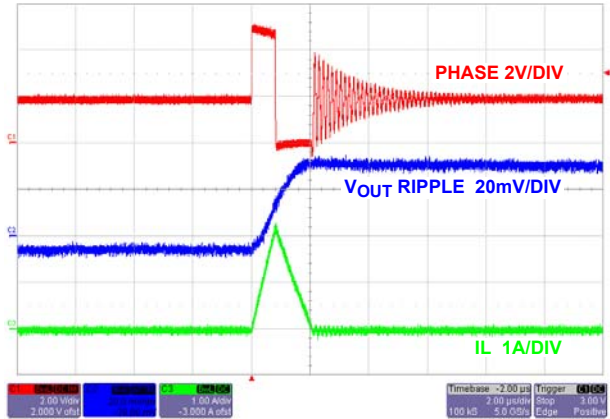

FIGURE 18. STEADY STATE OPERATION AT NO LOAD (PFM)

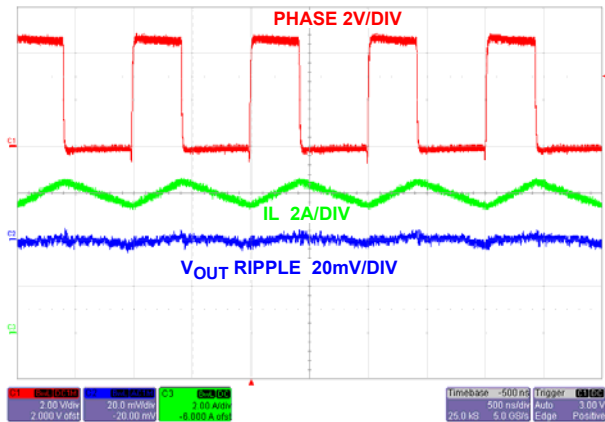

FIGURE 19. STEADY STATE OPERATION WITH FULL LOAD

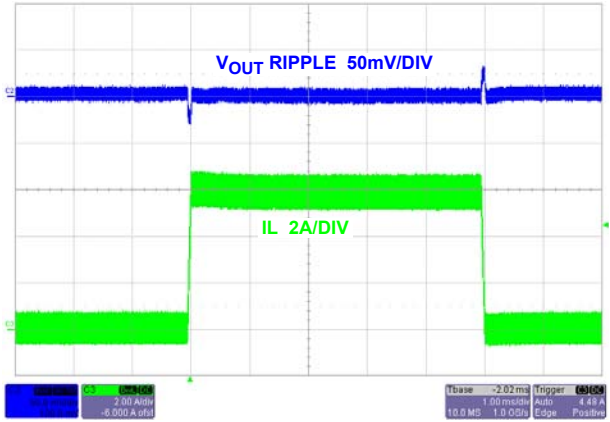

FIGURE 20. LOAD TRANSIENT (PWM)

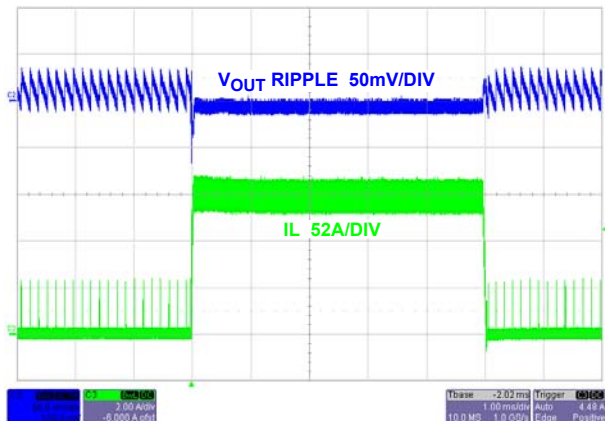

FIGURE 21. LOAD TRANSIENT (PFM)

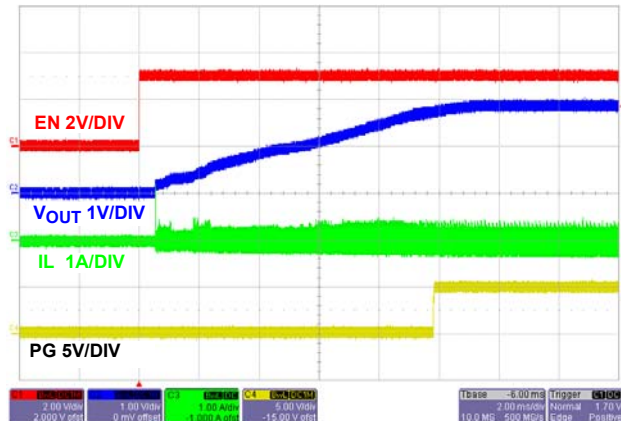

FIGURE 22. SOFT-START WITH NO LOAD (PWM)

# Typical Operating Performance

Unless otherwise noted, operating conditions are:  $T_A = +25^\circ\text{C}$ ,  $V_{IN} = 5\text{V}$ ,  $EN = 3.3\text{V}$ ,  $\text{SYNCIN} = V_{IN}$ ,  $L = 1.0\mu\text{H}$ ,  $C_1 = 2 \times 22\mu\text{F}$ ,  $C_2 = 4 \times 22\mu\text{F}$ ,  $V_{OUT} = 1.8\text{V}$ ,  $I_{OUT} = 0\text{A to } 6\text{A}$ . (Continued)

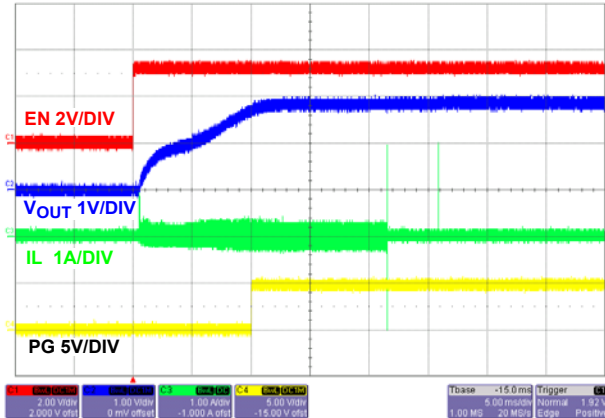

FIGURE 23. SOFT-START AT NO LOAD (PFM)

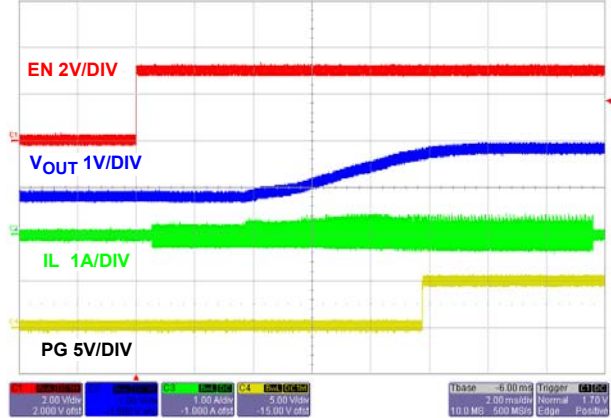

FIGURE 24. SOFT-START WITH PRE-BIASED 1V

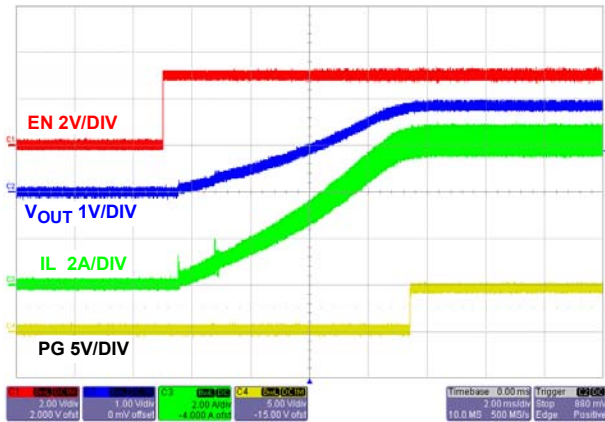

FIGURE 25. SOFT-START AT FULL LOAD

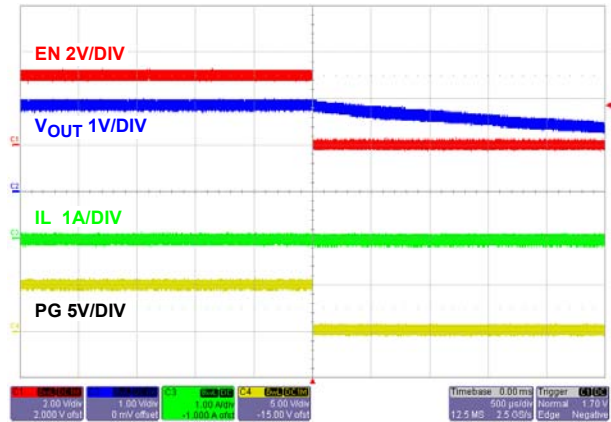

FIGURE 26. SOFT-DISCHARGE SHUTDOWN

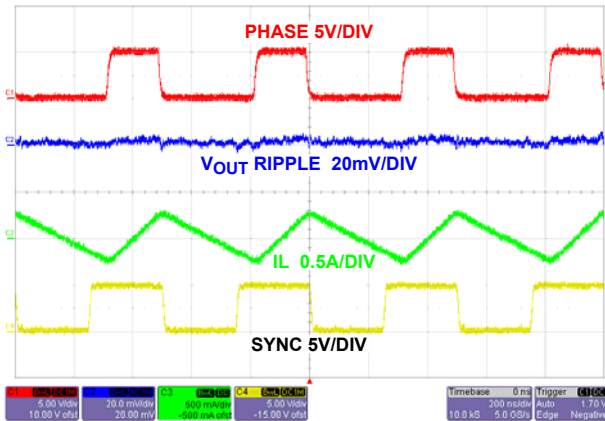

FIGURE 27. STEADY STATE OPERATION AT NO LOAD WITH FREQUENCY = 2MHz

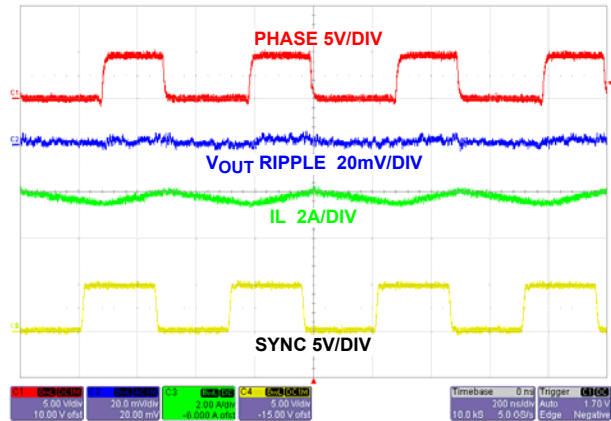

FIGURE 28. STEADY STATE OPERATION AT FULL LOAD WITH FREQUENCY = 2MHz

## Typical Operating Performance

Unless otherwise noted, operating conditions are:  $T_A = +25^\circ\text{C}$ ,  $V_{IN} = 5\text{V}$ ,  $EN = 3.3\text{V}$ ,  $SYNCIN = V_{IN}$ ,  $L = 1.0\mu\text{H}$ ,  $C_1 = 2 \times 22\mu\text{F}$ ,  $C_2 = 4 \times 22\mu\text{F}$ ,  $V_{OUT} = 1.8\text{V}$ ,  $I_{OUT} = 0\text{A}$  to  $6\text{A}$ . (Continued)

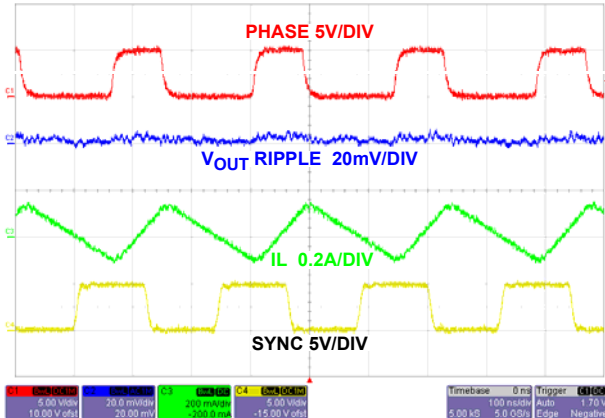

FIGURE 29. STEADY STATE OPERATION AT NO LOAD WITH FREQUENCY = 4MHz

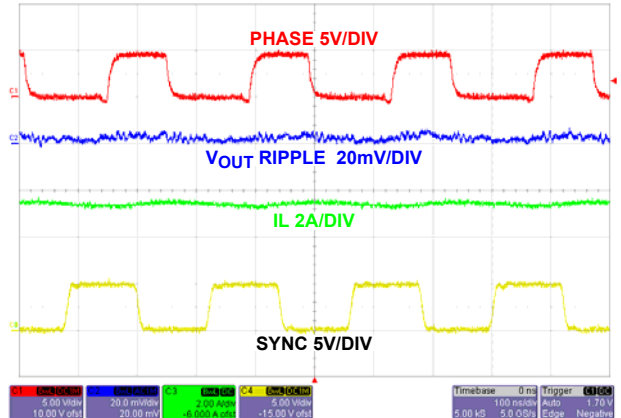

FIGURE 30. STEADY STATE OPERATION AT FULL LOAD (PWM) WITH FREQUENCY = 4MHz

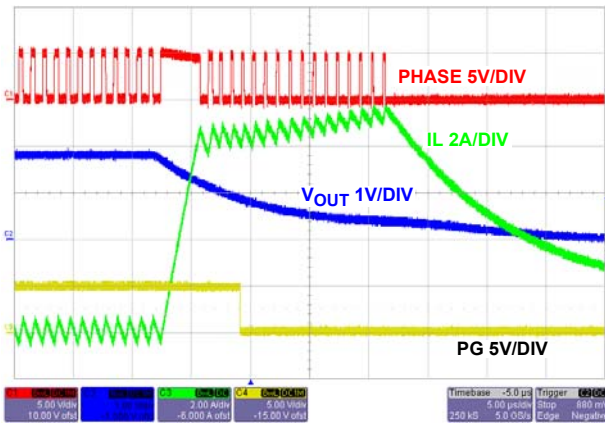

FIGURE 31. OUTPUT SHORT CIRCUIT

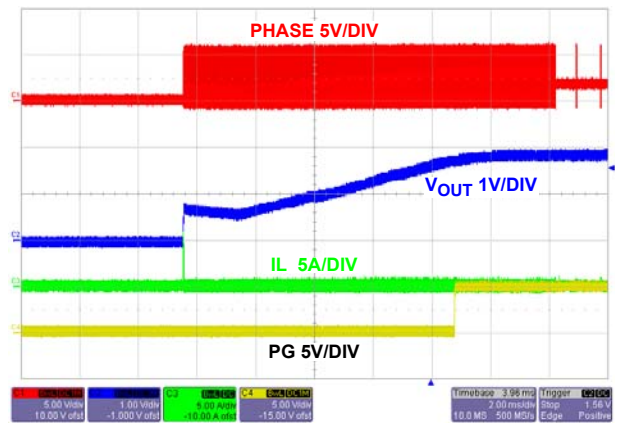

FIGURE 32. OUTPUT SHORT CIRCUIT RECOVERY



## Theory of Operation

The ISL8016 is a step-down switching regulator optimized for battery-powered handheld applications. The regulator operates at 1MHz fixed default switching frequency when FS is connected to VIN. By connecting a resistor from FS to SGND, the operating frequency may be adjusted from 500kHz to 4MHz. Unless forced, PWM is chosen (SYNCIN pulled HI), the regulator will allow PFM operation and reduce switching frequency at light loading to maximize efficiency. In this condition, no load quiescent is typically 70µA.

### PWM Control Scheme

Pulling the SYNCIN high (>0.8V) forces the converter into PWM mode, regardless of output current. The ISL8016 employs the current-mode pulse-width modulation (PWM) control scheme for fast transient response and pulse-by-pulse current limiting. Figure 4 shows the block diagram. The current loop consists of the oscillator, the PWM comparator, current sensing circuit and the slope compensation for the current loop stability. The slope compensation is 360mV/Ts. Current sense resistance,  $R_t$ , is typically 0.138V/A. The control reference for the current loop comes from the error amplifier's (EAMP) output.

The PWM operation is initialized by the clock from the oscillator. The P-Channel MOSFET is turned on at the beginning of a PWM cycle and the current in the MOSFET starts to ramp up. When the sum of the current amplifier CSA and the slope compensation reaches the control reference of the current loop, the PWM comparator EAMP output sends a signal to the PWM logic to turn off the P-FET and turn on the N-Channel MOSFET. The N-FET stays on until the end of the PWM cycle. Figure 33 shows the typical operating waveforms during the PWM operation. The dotted lines illustrate the sum of the slope compensation ramp and the current-sense amplifier's CSA output.

The output voltage is regulated by controlling the  $V_{EAMP}$  voltage to the current loop. The bandgap circuit outputs a 0.6V reference voltage to the voltage loop. The feedback signal comes from the VFB pin. The soft-start block only affects the operation during the start-up and will be discussed separately. The error amplifier is a transconductance amplifier that converts the voltage error signal to a current output. The voltage loop is internally compensated with the 55pF and 168kΩ RC network. The maximum EAMP voltage output is precisely clamped to 2.4V.

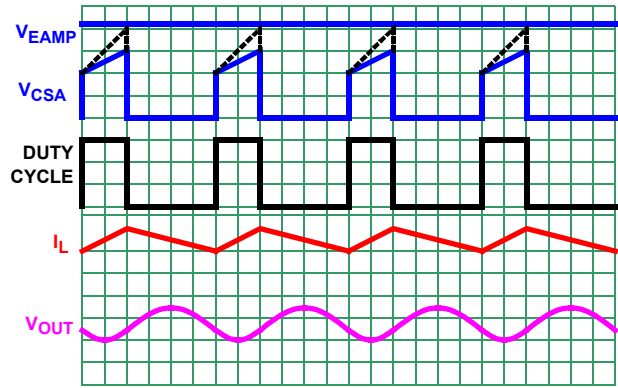

FIGURE 33. PWM OPERATION WAVEFORMS

### SKIP Mode

Pulling the SYNCIN pin LO (<0.4V) forces the converter into PFM mode. The ISL8016 enters a pulse-skipping mode at light load to minimize the switching loss by reducing the switching frequency. Figure 34 illustrates the skip-mode operation. A zero-cross sensing circuit shown in Figure 4 monitors the N-FET current for zero crossing. When 8 consecutive cycles of the inductor current crossing zero are detected, the regulator enters the skip mode. During the eight detecting cycles, the current in the inductor is allowed to become negative. The counter is reset to zero when the current in any cycle does not cross zero.

Once the skip mode is entered, the pulse modulation starts being controlled by the SKIP comparator shown in Figure 34. Each pulse cycle is still synchronized by the PWM clock. The P-FET is turned on at the clock's rising edge and turned off when the output is higher than 1.5% of the nominal regulation or when its current reaches the peak Skip current limit value. Then the inductor current is discharging to 0A and stays at zero. The internal clock is disabled. The output voltage reduces gradually due to the load current discharging the output capacitor. When the output voltage drops to the nominal voltage, the P-FET will be turned on again at the rising edge of the internal clock as it repeats the previous operations.

The regulator resumes normal PWM mode operation when the output voltage drops 1.5% below the nominal voltage.

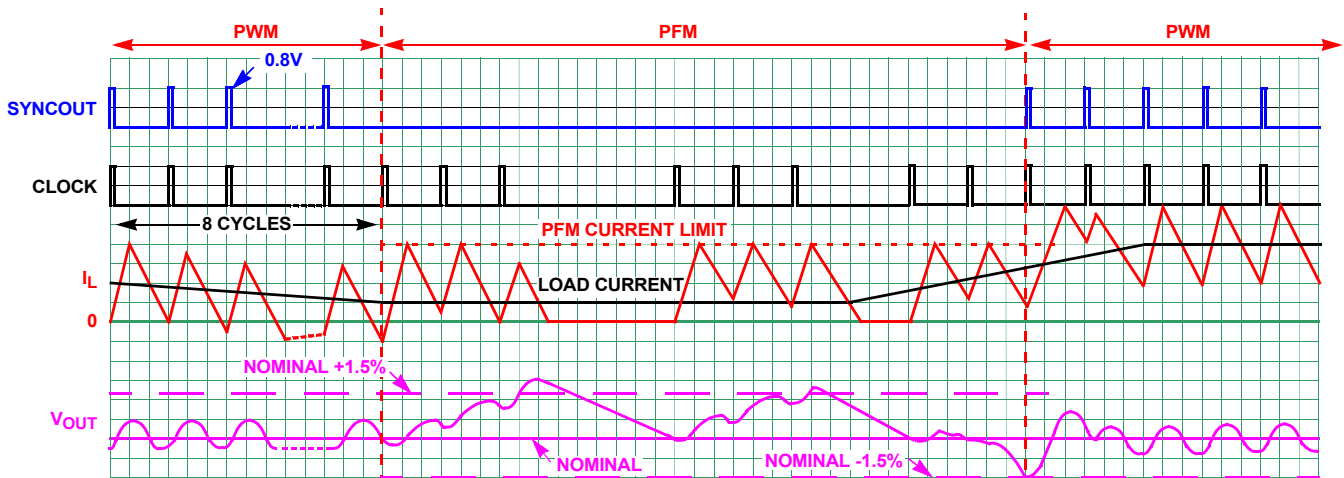

FIGURE 34. SKIP MODE OPERATION WAVEFORMS

### Frequency Adjust

The frequency of operation is fixed at 1MHz and internal compensation when FS is tied to VIN. Adjustable frequency ranges from 500kHz to 4MHz via a simple resistor connecting FS to SGND according to Equation 1:

$$R_T[k\Omega] = \frac{220 \cdot 10^3}{f_{OSC}[kHz]} - 14 \tag{EQ. 1}$$

Figure 35 is a graph of the measured Frequency vs RT for a VIN of 2.7V and 5.5V.

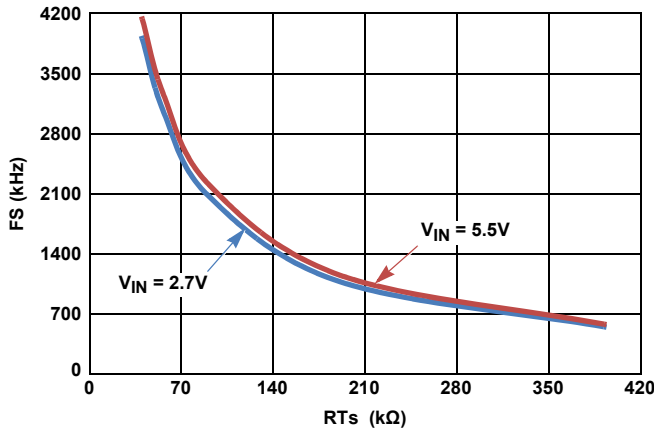

FIGURE 35. FREQUENCY vs RTs

### Synchronization Control

The ISL8016 can be synchronized from 500kHz to 4MHz by an external signal applied to the SYNCIN pin. SYNCIN frequency should be greater than 50% of internal clock frequency. The rising edge on the SYNCIN triggers the rising edge of the PHASE pulse. Make sure that the minimum on time of the PHASE node is greater than 140ns.

SYNCOUT is a 250µA current pulse signal output trigger on by rising edge of the clock or SYNCIN signal (whichever is greater in frequency) to drive other ISL8016 and avoid system’s beat frequencies effect. See Figure 36 for more detail. The current pulse is terminated and SYNCOUT is discharged to 0V after 0.8V threshold is reached. SYNCOUT is 0V if the regulator operates at light PFM load.

To implement time shifting between the master circuit to the slave, it is recommended to add a capacitor, C13 as shown in Figure 3. The time delay from SYNCOUT\_Master to SYNCIN\_Slave as shown in Figure 3 is calculated in pF using Equation 2:

$$C_{13}(pF) = 0.333 \cdot (t - 20)(ns) \tag{EQ. 2}$$

Where t is the desired time shift between the master and the slave circuits in ns. Care must be taken to include PCB parasitic capacitance of ~3pF to 10pF.

The maximum should be limited to 1/Fs-100ns to insure that SYNCOUT has enough time to discharge before the next cycle starts.

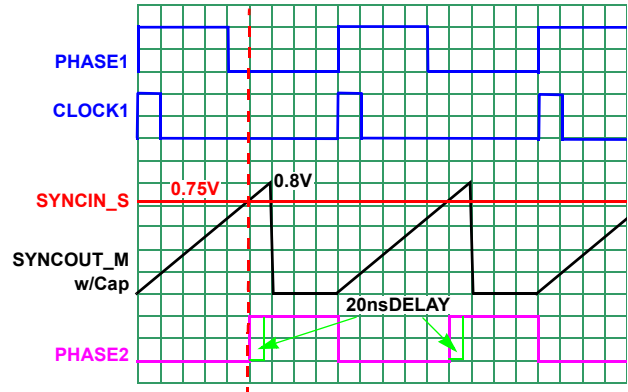

FIGURE 36. SYNCHRONIZATION WAVEFORMS

Figure 37 is a graph of the Master to Slave phase shift vs SYNCOUT capacitance for 1MHz switching operation.

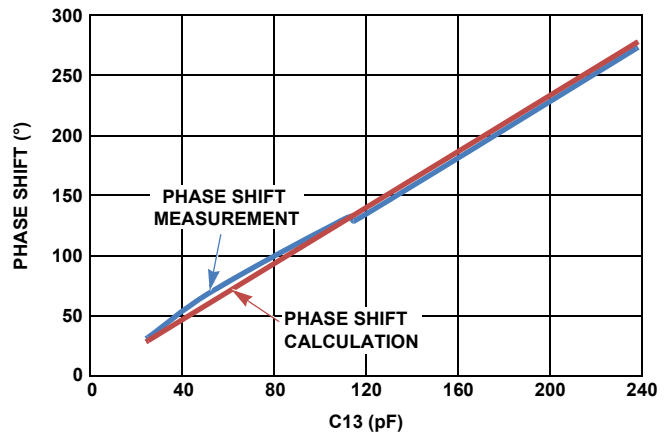

FIGURE 37. PHASE SHIFT vs CAPACITANCE

### Overcurrent Protection

The overcurrent protection is realized by monitoring the CSA output with the OCP comparator, as shown in Figure 4. The current sensing circuit has a gain of 138mV/A, from the P-FET current to the CSA output. When the CSA output reaches a threshold set by ISET, the OCP comparator is tripped to turn off the P-FET immediately. See “Analog Specifications” on page 7 of the OCP threshold for various ISET configurations. The overcurrent function protects the switching converter from a shorted output by monitoring the current flowing through the upper MOSFET.

Upon detection of overcurrent condition, the upper MOSFET will be immediately turned off and will not be turned on again until the next switching cycle. Upon detection of the initial overcurrent condition, the overcurrent fault counter is set to 1. If, on the subsequent cycle, another overcurrent condition is detected, the OC fault counter will be incremented. If there are 17 sequential OC fault detections, the regulator will be shut down under an overcurrent fault condition. An overcurrent fault condition will result in the regulator attempting to restart in a hiccup mode within the delay of eight soft-start periods. At the end of the eight soft-start wait period, the fault counters are reset and soft-start is attempted again. If the overcurrent condition goes away during the delay of eight soft-start periods, the output will resume back into regulation point after hiccup mode expires.



## Negative Current Protection

Similar to the overcurrent, the negative current protection is realized by monitoring the current across the low-side N-FET, as shown in Figure 4. When the valley point of the inductor current reaches  $-3A$  for 4 consecutive cycles, both P-FET and N-FET are off. The  $100\Omega$  in parallel to the N-FET will activate discharging the output into regulation. The control will begin to switch when output is within regulation. The regulator will be in PFM for  $20\mu s$  before switching to PWM if necessary.

## PG

PG is an open-drain output of a window comparator that continuously monitors the buck regulator output voltage. PG is actively held low when EN is low and during the buck regulator soft-start period. After 1ms delay of the soft-start period, PG becomes high impedance as long as the output voltage is within nominal regulation voltage set by VFB. When VFB drops 15% below or raises 0.8V above the nominal regulation voltage, the ISL8016 pulls PG low. Any fault condition forces PG low until the fault condition is cleared by attempts to soft-start. For logic level output voltages, connect an external pull-up resistor,  $R_1$ , between PG and VIN. A  $100k\Omega$  resistor works well in most applications.

## UVLO

When the input voltage is below the undervoltage lock-out (UVLO) threshold, the regulator is disabled.

## Soft Start-Up

The soft start-up reduces the in-rush current during the start-up. The soft-start block outputs a ramp reference to the input of the error amplifier. This voltage ramp limits the inductor current as well as the output voltage speed so that the output voltage rises in a controlled fashion. When VFB is less than 0.1V at the beginning of the soft-start, the switching frequency is reduced to 200kHz so that the output can start-up smoothly at light load condition. During soft-start, the IC operates in the SKIP mode to support pre-biased output condition.

Tie SS to SGND for an internal soft-start of approximately 1ms. Connect a capacitor from SS to SGND to adjust the soft-start time. This capacitor, along with an internal  $1.6\mu A$  current source sets the soft-start interval of the converter,  $t_{SS}$ .

$$C_{SS}[\mu F] = 3.33 \cdot t_{SS}[s] \quad (\text{EQ. 3})$$

$C_{SS}$  must be less than 33nF to insure proper soft-start reset after fault condition.

Figure 38 is a comparison between measured and calculated output soft-start time versus  $C_{SS}$  capacitance.

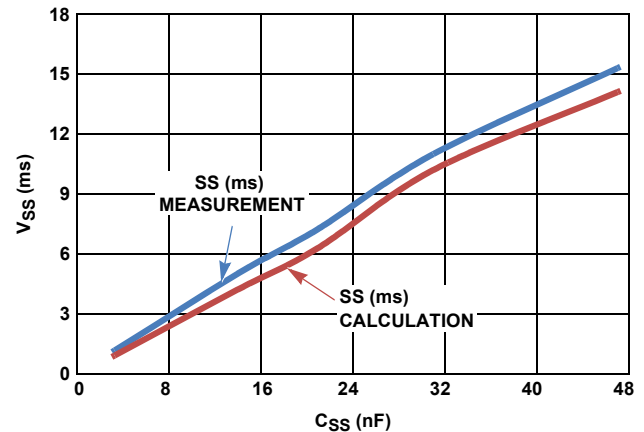

FIGURE 38. SOFT-START TIME vs  $C_{SS}$

## Enable

The enable (EN) input allows the user to control the turning on or off of the regulator for purposes such as power-up sequencing. When the regulator is enabled, there is typically a  $600\mu s$  delay for waking up the bandgap reference and then the soft start-up begins.

## Discharge Mode (Soft-Stop)

When a transition to shutdown mode occurs or the VIN UVLO is set, the outputs discharge to GND through an internal  $100\Omega$  switch. The discharge mode is disabled if SS is tied to an external capacitor.

## Power MOSFETs

The power MOSFETs are optimized for best efficiency. The ON-resistance for the P-FET is typically  $30m\Omega$  and the ON-resistance for the N-FET is typically  $20m\Omega$ .

## 100% Duty Cycle

The ISL8016 features 100% duty cycle operation to maximize the battery life. When the battery voltage drops to a level that the ISL8016 can no longer maintain the regulation at the output, the regulator completely turns on the P-FET. The maximum dropout voltage under the 100% duty-cycle operation is the product of the load current and the ON-resistance of the P-FET.

## Thermal Shutdown

The ISL8016 has built-in thermal protection. When the internal temperature reaches  $+150^\circ C$ , the regulator is completely shut down. As the temperature drops to  $+125^\circ C$ , the ISL8016 resumes operation by stepping through the soft-start.

## Applications Information

### Output Inductor and Capacitor Selection

To consider steady state and transient operations, ISL8016 typically uses a 1.0μH output inductor. The higher or lower inductor value can be used to optimize the total converter system performance. For example, for higher output voltage 3.3V application, in order to decrease the inductor current ripple and output voltage ripple, the output inductor value can be increased. It is recommended to set the ripple inductor current approximately 30% of the maximum output current for optimized performance. The inductor ripple current can be expressed as shown in Equation 4:

$$\Delta I = \frac{V_O \cdot \left(1 - \frac{V_O}{V_{IN}}\right)}{L \cdot f_S} \quad (\text{EQ. 4})$$

The inductor's saturation current rating needs to be at least larger than the peak current. The ISL8016 protects the typical peak current of 9A. The saturation current needs to be over 12A for maximum output current application.

The ISL8016 uses an internal compensation network and the output capacitor value is dependent on the output voltage. The ceramic capacitor is recommended to be X5R or X7R.

In Table 1, the minimum output capacitor value is given for the different output voltages to make sure that the whole converter system is stable. Additional output capacitance may be added for improved transient response.

### Output Voltage Selection

The output voltage of the regulator can be programmed via an external resistor divider that is used to scale the output voltage relative to the internal reference voltage and feed it back to the inverting input of the error amplifier (refer to Figure 2).

The output voltage programming resistor,  $R_2$ , will depend on the value chosen for the feedback resistor and the desired output voltage of the regulator. The value for the feedback resistor is typically between 10kΩ and 100kΩ, as shown in Equation 5.

$$R_2 = R_3 \left( \frac{V_O}{V_{FB}} - 1 \right) \quad (\text{EQ. 5})$$

If the output voltage desired is 0.6V, then  $R_3$  is left unpopulated and  $R_2$  is shorted. There is a leakage current from  $V_{IN}$  to PHASE. It is recommended to preload the output with 10μA minimum. Capacitance,  $C_3$ , maybe added to improve transient performance. A good starting point for  $C_3$  can be determined by choosing a value that provides an 80kHz corner frequency with  $R_2$ .

VSET marginally adjusts VFB according to the "Analog Specifications" on page 7.

Figure 39 is the recommended minimum output voltage setting vs operational frequency in order to avoid the minimum On-Time specification.

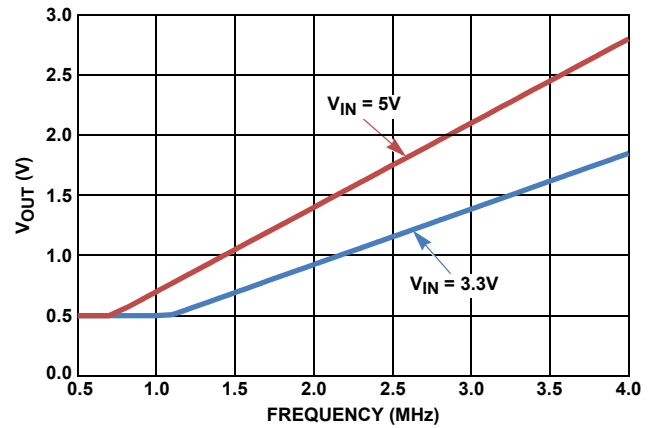

FIGURE 39. MINIMUM  $V_{OUT}$  vs FREQUENCY

### Input Capacitor Selection

The main functions for the input capacitor are to provide decoupling of the parasitic inductance and to provide filtering function to prevent the switching current flowing back to the battery rail. At least two 22μF X5R or X7R ceramic capacitors are a good starting point for the input capacitor selection.

### Loop Compensation Design

When there is an external resistor connected from FS to SGND, the COMP pin is active for external loop compensation. The ISL8016 uses constant frequency peak current mode control architecture to achieve fast loop transient response. An accurate current sensing pilot device in parallel with the upper MOSFET is used for peak current control signal and overcurrent protection. The inductor is not considered as a state variable since its peak current is constant, and the system becomes single order system. It is much easier to design a type II compensator to stabilize the loop than to implement voltage mode control. Peak current mode control has inherent input voltage feed-forward function to achieve good line regulation. Figure 40 shows the small signal model of the synchronous buck regulator.

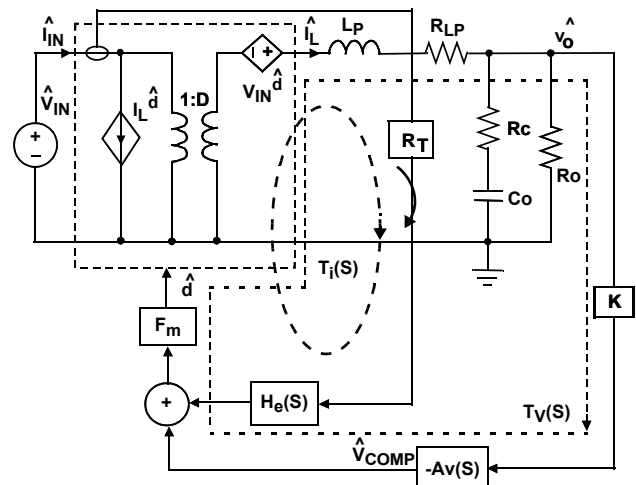

FIGURE 40. SMALL SIGNAL MODEL OF SYNCHRONOUS BUCK REGULATOR

**PWM COMPARATOR GAIN  $F_m$ :**

The PWM comparator gain  $F_m$  for peak current mode control is given by Equation 6:

$$F_m = \frac{\hat{d}}{v_{comp}} = \frac{1}{(S_e + S_n)T_s} \quad (\text{EQ. 6})$$

Where,  $S_e$  is the slew rate of the slope compensation and  $S_n$  is given by Equation 7:

$$S_n = R_t \frac{V_{in} - V_o}{L_p} \quad (\text{EQ. 7})$$

Where  $R_t$  is trans-resistance, which is the gain of the current amplifier.

**CURRENT SAMPLING TRANSFER FUNCTION  $H_e(S)$ :**

In current loop, the current signal is sampled every switching cycle. It has the following transfer function:

$$H_e(S) = \frac{S^2}{\omega_n^2} + \frac{S}{\omega_n Q_n} + 1 \quad (\text{EQ. 8})$$

where  $Q_n$  and  $\omega_n$  are given by  $Q_n = -\frac{2}{\pi}$ ,  $\omega_n = \pi f_s$

**Power Stage Transfer Functions**

Transfer function  $F_1(S)$  from control to output voltage is:

$$F_1(S) = \frac{\hat{v}_o}{d} = V_{in} \frac{1 + \frac{S}{\omega_{esr}}}{\frac{S^2}{\omega_o^2} + \frac{S}{\omega_o Q_p} + 1} \quad (\text{EQ. 9})$$

Where  $\omega_{esr} = \frac{1}{R_c C_o}$ ,  $Q_p \approx R_o \sqrt{\frac{C_o}{L_p}}$ ,  $\omega_o = \frac{1}{\sqrt{L_p C_o}}$

Transfer function  $F_2(S)$  from control to inductor current is given by Equation 10:

$$F_2(S) = \frac{\hat{i}_o}{d} = \frac{V_{in}}{R_o + R_{LP}} \frac{1 + \frac{S}{\omega_z}}{\frac{S^2}{\omega_o^2} + \frac{S}{\omega_o Q_p} + 1} \quad (\text{EQ. 10})$$

where  $\omega_z = \frac{1}{R_o C_o}$ .

Current loop gain  $T_i(S)$  is expressed as Equation 11:

$$T_i(S) = R_t F_m F_2(S) H_e(S) \quad (\text{EQ. 11})$$

The voltage loop gain with open current loop is:

$$T_v(S) = K F_m F_1(S) A_v(S) \quad (\text{EQ. 12})$$

The Voltage loop gain with current loop closed is given by Equation 13:

$$L_v(S) = \frac{T_v(S)}{1 + T_i(S)} \quad (\text{EQ. 13})$$

Where  $K = \frac{V_{FB}}{V_o}$ ,  $V_{FB}$  is the feedback voltage of the voltage error amplifier. If  $T_i(S) \gg 1$ , then Equation 13 can be simplified by Equation 14:

$$L_v(S) = \frac{V_{FB} R_o + R_{LP}}{V_o} \frac{1 + \frac{S}{\omega_{esr}}}{1 + \frac{S}{\omega_p}} A_v(S), \omega_p \approx \frac{1}{R_o C_o} \quad (\text{EQ. 14})$$

From Equation 14, it is shown that the system is a single order system, which has a single pole located at  $\omega_p$  before the half switching frequency. Therefore, a simple type II compensator can be easily used to stabilize the system.

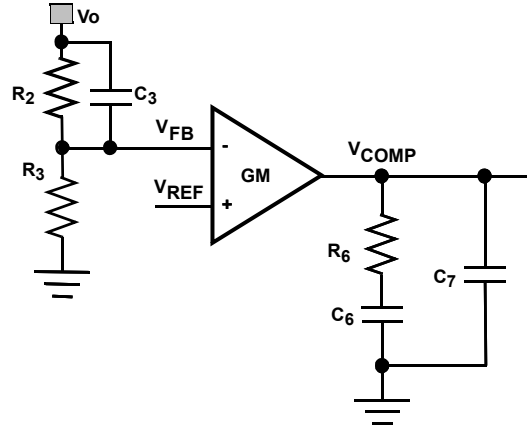

FIGURE 41. TYPE II COMPENSATOR

Figure 41 shows the type II compensator and its transfer function is expressed as follows:

$$A_v(S) = \frac{\hat{v}_{comp}}{v_{FB}} = \frac{GM}{C_6 + C_7} \frac{\left(1 + \frac{S}{\omega_{cz1}}\right) \left(1 + \frac{S}{\omega_{cz2}}\right)}{S \left(1 + \frac{S}{\omega_{cp}}\right)} \quad (\text{EQ. 15})$$

Where  $\omega_{cz1} = \frac{1}{R_6 C_6}$ ,  $\omega_{cz2} = \frac{1}{R_2 C_3}$ ,  $\omega_{cp} = \frac{C_6 + C_7}{R_6 C_6 C_7}$

Compensator design goal:

High DC gain

Loop bandwidth  $f_c$ :  $\left(\frac{1}{4} \text{ to } \frac{1}{10}\right) f_s$

Gain margin: >10dB

Phase margin: 40°

The compensator design procedure is as follows:

Put compensator zero  $\omega_{cz1} = (1 \text{ to } 3) \frac{1}{R_o C_o}$

Put one compensator pole at zero frequency to achieve high DC gain, and put another compensator pole at either ESR zero frequency or half switching frequency, whichever is lower. An optional zero can boost the phase margin.  $\omega_{cz2}$  is a zero due to  $R_2$  and  $C_3$ .

Put compensator zero  $\omega_{cz2} = (5 \text{ to } 8) \frac{1}{R_o C_o}$

The loop gain  $T_v(S)$  at cross over frequency of  $f_c$  has unity gain. Therefore, the compensator resistance  $R_6$  is determined by:

$$R_6 = \frac{2\pi f_c V_o C_o R_t}{GM \cdot V_{FB}} \quad (\text{EQ. 16})$$

where GM is the sum of the trans-conductance,  $g_m$ , of the voltage error amplifier in each phase. Compensator capacitor  $C_6$  is then given by:

$$C_6 = \frac{1}{R_6 \omega_{cz}}, C_7 = \frac{1}{2\pi R_6 f_{esr}} \quad (\text{EQ. 17})$$

Example:  $V_{IN} = 5V$ ,  $V_O = 2.5V$ ,  $I_O = 6A$ ,  $f_s = 1MHz$ ,  $C_O = 44\mu F/3m\Omega$ ,  $L = 1\mu H$ ,  $GM = 100\mu s$ ,  $R_t = 0.25V/A$ ,  $V_{FB} = 0.6V$ ,  $S_e = 0.15V/\mu s$ ,  $S_n = 2.55 \times 10^5 V/s$ ,  $f_c = 100kHz$ , then compensator resistance  $R_6 = 120k\Omega$ .

Put the compensator zero at 1.5kHz ( $\sim 1.5 \times C_O R_O$ ), and put the compensator pole at ESR zero which is 390kHz. The compensator capacitors are:

$C_6 = 220pF$ ,  $C_7 = 3pF$  (there is approximately 3pF parasitic capacitance from  $V_{COMP}$  to GND; therefore,  $C_7$  optional).

Figure 42 shows the simulated loop gain response. It is shown that it has 95kHz loop bandwidth with 79° phase margin and at least 10dB gain margin.

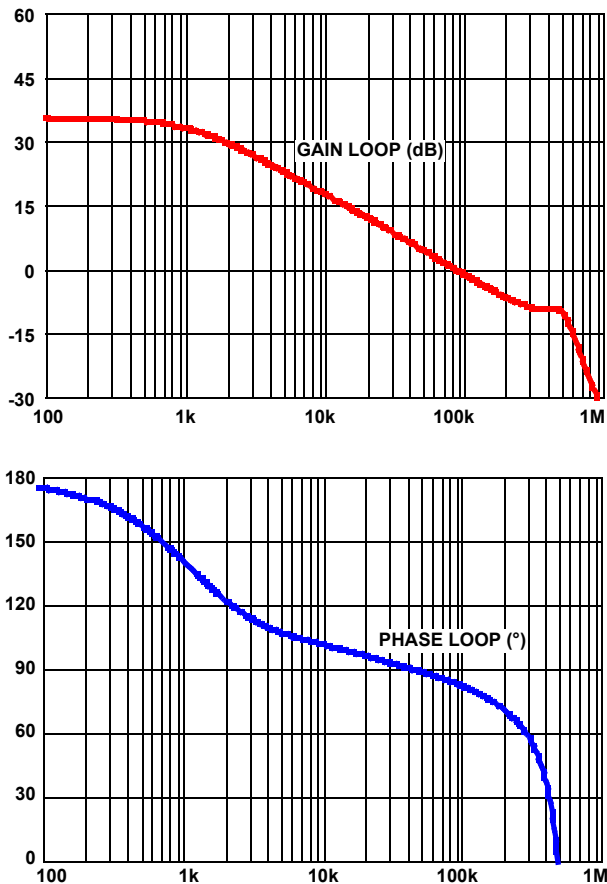

FIGURE 42. SIMULATED LOOP GAIN

## PCB Layout Recommendation

The PCB layout is a very important converter design step to make sure the designed converter works well. For ISL8016, the power loop is composed of the output inductor L's, the output capacitor  $C_{OUT}$ , the PHASE's pins, and the PGND pin. It is necessary to make the power loop as small as possible and the connecting traces among them should be direct, short and wide. The switching node of the converter, the PHASE pins, and the traces connected to the node are very noisy, so keep the voltage feedback trace away from these noisy traces. The input capacitor should be placed as close as possible to the  $V_{IN}$  pin, and the ground of the input and output capacitors should be connected as close as possible. The heat of the IC is mainly dissipated through the thermal pad. Maximizing the copper area connected to the thermal pad is preferable. In addition, a solid ground plane is helpful for better EMI performance. It is recommended to add at least 5 vias ground connection within the pad for the best thermal relief.

## Revision History

The revision history provided is for informational purposes only and is believed to be accurate, but not warranted. Please go to web to make sure you have the latest Rev.

DATE	REVISION	CHANGE
4/21/11	FN7616.1	Figures 6 and 8 - smoothed curves.
3/31/11	FN7616.0	Initial Release.

## Products

Intersil Corporation is a leader in the design and manufacture of high-performance analog semiconductors. The Company's products address some of the industry's fastest growing markets, such as, flat panel displays, cell phones, handheld products, and notebooks. Intersil's product families address power management and analog signal processing functions. Go to [www.intersil.com/products](http://www.intersil.com/products) for a complete list of Intersil product families.

\*For a complete listing of Applications, Related Documentation and Related Parts, please see the respective device information page on intersil.com: [ISL8016](http://www.intersil.com/ISL8016)

To report errors or suggestions for this datasheet, please go to: [www.intersil.com/askourstaff](http://www.intersil.com/askourstaff)

FITs are available from our website at: <http://rel.intersil.com/reports/sear>

© Copyright Intersil Americas LLC 2011. All Rights Reserved.

All trademarks and registered trademarks are the property of their respective owners.

For additional products, see [www.intersil.com/en/products.html](http://www.intersil.com/en/products.html)

Intersil products are manufactured, assembled and tested utilizing ISO9001 quality systems as noted in the quality certifications found at [www.intersil.com/en/support/qualandreliability.html](http://www.intersil.com/en/support/qualandreliability.html)

*Intersil products are sold by description only. Intersil may modify the circuit design and/or specifications of products at any time without notice, provided that such modification does not, in Intersil's sole judgment, affect the form, fit or function of the product. Accordingly, the reader is cautioned to verify that datasheets are current before placing orders. Information furnished by Intersil is believed to be accurate and reliable. However, no responsibility is assumed by Intersil or its subsidiaries for its use; nor for any infringements of patents or other rights of third parties which may result from its use. No license is granted by implication or otherwise under any patent or patent rights of Intersil or its subsidiaries.*

For information regarding Intersil Corporation and its products, see [www.intersil.com](http://www.intersil.com)