

ISL8023EVAL3Z, ISL8024EVAL3Z

Evaluation Board

AN1759
Rev 1.00
Sep 10, 2015

Description

The ISL8023EVAL3Z, ISL8024EVAL3Z boards are intended for use by individuals with requirements for point-of-load applications sourcing from 2.7V to 5.5V. The ISL8023EVAL3Z, ISL8024EVAL3Z simple smallest factor evaluation boards are used for a quick and easy demonstration of the performance of the [ISL8023](#), [ISL8024](#) low quiescent high efficiency synchronous buck regulator.

The ISL8023 and ISL8024 are offered in a 3mmx3mm 16 Ld TQFN package with 1mm maximum height. The complete area that the converter occupies can be as small as 0.22in².

Specifications

PART NUMBER	V _{IN} RANGE (V)	V _{OUT} RANGE (V)	I _{OUT} (MAX) (A)	f _{SW} RANGE (MHz)	PART SIZE (2mm)
8023	2.7V to 5.5V		3	Programmable 0.5 to 4MHz	3x3
8024			4		

NOTES:

1. The evaluation boards default configuration is V_{OUT} = 1.8V, f_{SW} = 1MHz (FS tied to V_{IN})
2. V_{REF} is 0.6V

Key Features

- High efficiency synchronous buck regulator with up to 95% efficiency
- 0.8% reference accuracy over temperature/load/line
- Start-up with prebiased output
- Internal soft-start - 1ms or adjustable
- Soft-stop output discharge during disabled
- Adjustable frequency from 500kHz to 4MHz - default at 1MHz
- External synchronization up to 4MHz
- Negative OC protection

References

[ISL8023](#), [ISL8024](#) Datasheet

Ordering Information

PART NUMBER	DESCRIPTION
ISL8023EVAL3Z	3A low quiescent current high efficiency synchronous buck regulator
ISL8024EVAL3Z	4A low quiescent current high efficiency synchronous buck regulator

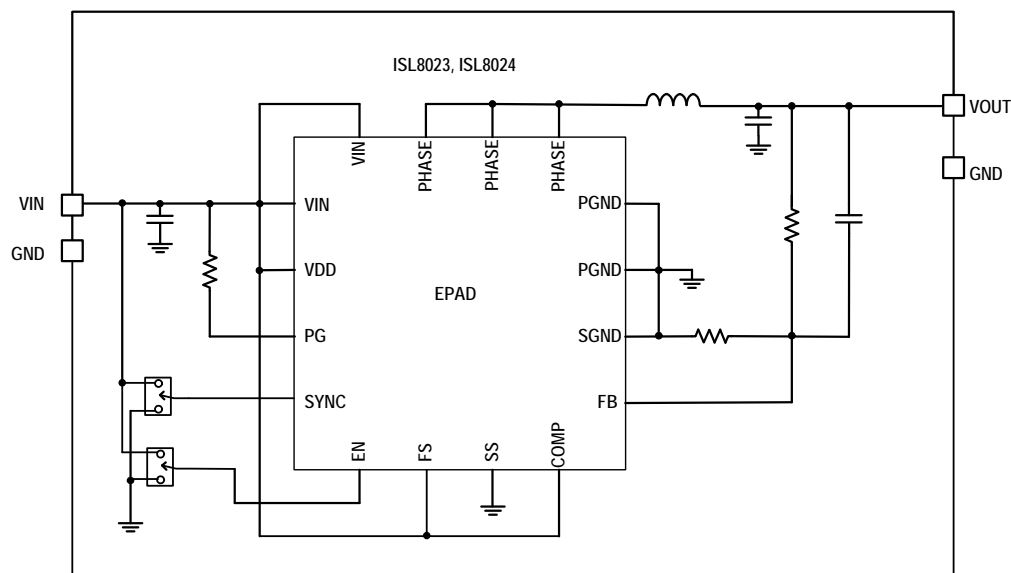

FIGURE 1. BLOCK DIAGRAM

Recommended Equipment

The following materials are recommended to perform testing:

- 0V to 10V power supply with at least 10A source current capability or 5V battery
- Electronic loads capable of sinking current up to 7A
- Digital Multimeters (DMMs)
- 100MHz quad-trace oscilloscope
- Signal generator

Quick Setup Guide

1. Ensure that the circuit is correctly connected to the supply and loads prior to applying any power.
2. Connect the bias supply to V_{IN} , the plus terminal to V_{IN} , P4 and the negative return to PGND, P5.
3. Connect the output load to V_{OUT} , the plus terminal to V_{OUT} , P3 and the negative return to PGND, P7.
4. Verify that the position is PWM for SW2.
5. Verify that the position is ON for SW1.
6. Turn on the power supply.
7. Verify the output voltage is 1.8V for V_{OUT} .

Evaluating the Other Output Voltage

The ISL8023EVAL3Z, ISL8024EVAL3Z board output is preset to 1.8V for V_{OUT} , however, output voltages can be adjusted from 0.6V to 5V. The output voltage programming resistor, R_1 , will depend on the desired output voltage of the regulator. The value for the feedback resistor is typically between 0 Ω and 200k Ω , as shown in [Equation 1](#).

$$R_2 = R_1 \left(\frac{V_{FB}}{V_{OUT} - V_{FB}} \right) \quad (\text{EQ. 1})$$

If the output voltage desired is 0.6V, then R_2 is left unpopulated and R_1 is shorted. For faster response performance, add 10pF to 47pF in parallel to R_1 . Check bode plot to insure optimum performance.

Frequency Control

The ISL8023, ISL8024 has an FS pin that controls the frequency of operation. Programmable frequency allows for optimization between efficiency and external component size. Default switching frequency is 1MHz when FS is tied to V_{IN} ($R_{11} = 0$ and R_{12} is open). By connecting R_{12} to GND, the switching frequency could be changed from 500kHz ($R_{12} = 426k$) to 4MHz ($R_{12} = 40k$) according to [Equation 2](#):

$$R_T[\text{k}\Omega] = \frac{220 \cdot 10^3}{f_{\text{OSC}}[\text{kHz}]} - 14 \quad (\text{EQ. 2})$$

When using R_{12} to adjust the operational frequency, this also sets external compensation mode. Please refer to the [ISL8023](#), [ISL8024](#) datasheet for more details.

Soft-start Control

Short CSS to SGND for internal soft-start (approximately 1ms). Populate CSS to adjust the soft-start time. This capacitor, along with an internal 1.6 μ A current source, sets the soft-start interval of the converter, t_{SS} .

$$\text{CSS}[\mu\text{F}] = 3.33 \cdot t_{SS}[\text{s}] \quad (\text{EQ. 3})$$

CSS must be less than 33nF to insure proper soft-start reset after fault condition.

Switches Control

The ISL8023, ISL8024 evaluation boards contain SW1 and SW2 for various controls of the ISL8023, ISL8024 circuitries. [Table 1](#) details this function.

TABLE 1. SWITCH SETTINGS

SW1	ENABLE	FUNCTION
1	OFF	Disable V_{OUT}
3	ON	Enable V_{OUT}
SW2	MODE	FUNCTION
1	PWM	Fixed PWM frequency at light load
3	PFM	Force continuous mode

ISL8023EVAL3Z and ISL8024EVAL3Z Evaluation Boards



FIGURE 2. ISL8023EVAL3Z TOP



FIGURE 3. ISL8023EVAL3Z BOTTOM



FIGURE 4. ISL8024EVAL3Z TOP



FIGURE 5. ISL8024EVAL3Z BOTTOM

ISL8023EVAL3Z, ISL8024EVAL3Z Schematic

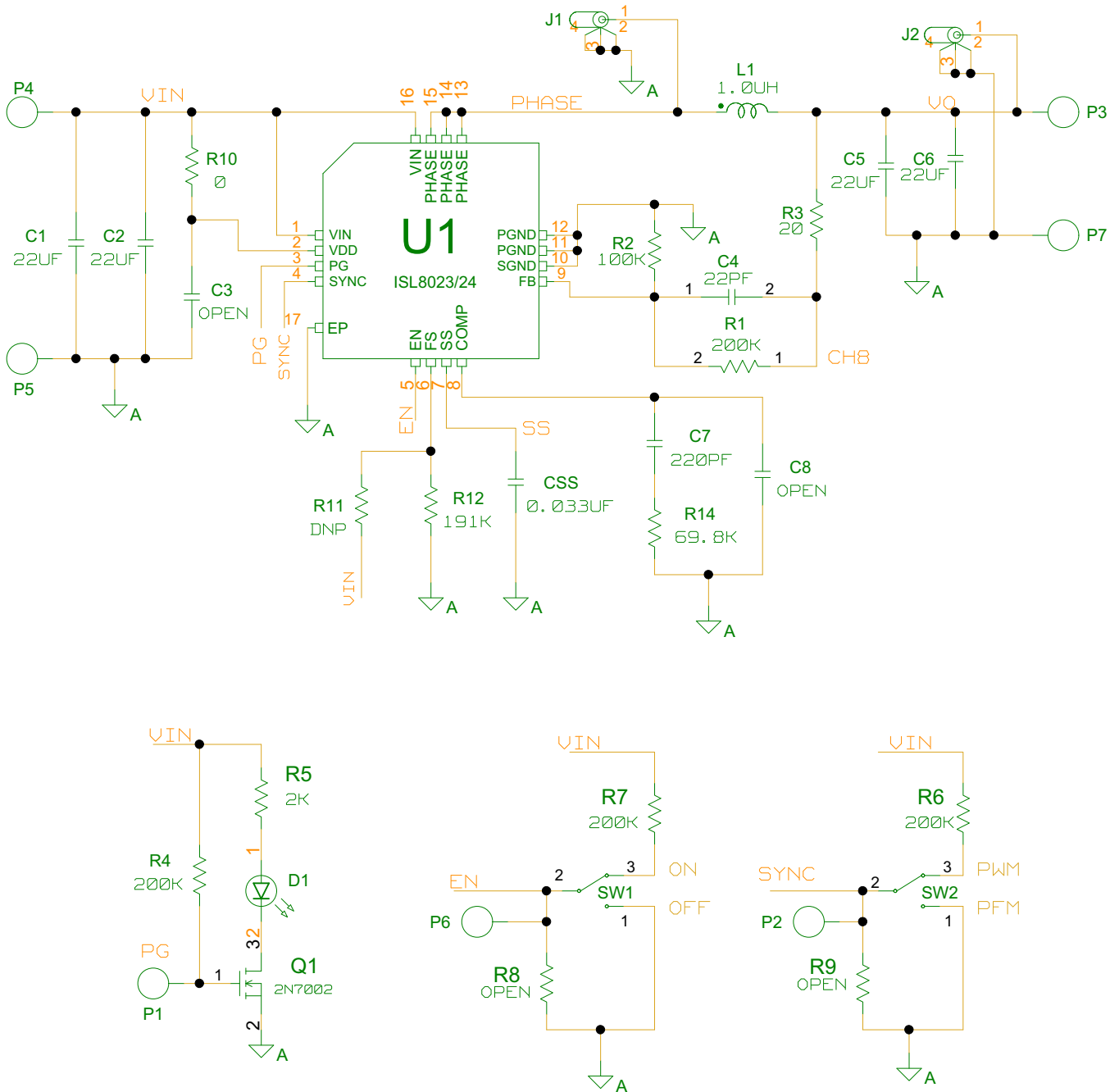

FIGURE 6. SCHEMATIC

TABLE 2. BILL OF MATERIALS

MANUFACTURER PART	QTY	UNITS	REFERENCE DESIGNATOR	DESCRIPTION	MANUFACTURER
ISL8023_24EVAL3ZREVAPCB	1	ea.		PWB-PCB, ISL8023_24EVAL3Z, REVA, ROHS	
C0603C0G500-220JNE	1	ea.	C4	CAP, SMD, 0603, 22pF, 50V, 5%, COG, ROHS	VENKEL
GRM188R71H221KA01D	1	ea.	C7	CAP, SMD, 0603, 220pF, 50V, 10%, X7R, ROHS	MURATA
C0603X7R160-333KNE	1	ea.	CSS	CAP, SMD, 0603, 33000pF, 16V, 10%, X7R, ROHS	VENKEL
	0	ea.	C3, C8	CAP, SMD, 0603, DNP-PLACE HOLDER, ROHS	
GRM31CR60J226KE19L	2	ea.	C2, C5	CAP, SMD, 1206, 22μF, 6.3V, 10%, X5R, ROHS	MURATA
	0	ea.	C1, C6	CAP, SMD, 1206, DNP-PLACE HOLDER, ROHS	
DR73-1R0-R	1	ea.	L1	COIL-PWR INDUCTOR, SMD, 7.6mm, 1.0μH, 20%, 5.28A, ROHS, SHIELDED	COOPER ELECTRONIC TECH.
131-4353-00	2	ea.	J1, J2	CONN-SCOPE PROBE TEST PT, COMPACT, PCB MNT, ROHS	TEKTRONIX
1514-2	4	ea.	P4, P5, P7, P8	CONN-TURRET, TERMINAL POST, TH, ROHS	KEYSTONE
5002	3	ea.	P1, P2, P6	CONN-MINI TEST POINT, VERTICAL, WHITE, ROHS	KEYSTONE
LTST-C170CKT	1	ea.	D1	LED-GaAs RED, SMD, 2x1.25mm, 100mW, 40mA, 10mcd, ROHS	LITEON/VISHAY
ISL8023/24IRZ	1	ea.	U1	IC-3A/4A BUCK REGULATOR, 16P, QFN, 3x3, ROHS	INTERSIL
2N7002-7-F	1	ea.	Q1	TRANSISTOR, N-CHANNEL, 3 LD, SOT-23, 60V, 115mA, ROHS	DIODES, INC.
	0	ea.	R11	RESISTOR, SMD, 0603, 0.1%, MF, DNP-PLACE HOLDER	
ERJ-3EKF20R0V	1	ea.	R3	RES, SMD, 0603, 20Ω, 1/10W, 1%, TF, ROHS	PANASONIC
CR0603-10W-000T	1	ea.	R10	RES, SMD, 0603, 0Ω, 1/10W, TF, ROHS	VENKEL
CR0603-10W-1003FT	2	ea.	R2, R14	RES, SMD, 0603, 100k, 1/10W, 1%, TF, ROHS	VENKEL
CR-0603-10W-1913FT	1	ea.	R12	RES, SMD, 0603, 191k, 1/10W, 1%, TF, ROHS	VENKEL
CR0603-10W-2003FT	4	ea.	R1, R4, R6, R7	RES, SMD, 0603, 200k, 1/10W, 1%, TF, ROHS	VENKEL
	0	ea.	R5, R8, R9	RES, SMD, 0603, DNP-PLACE HOLDER, ROHS	
GT11MSCBE	2	ea.	SW1, SW2	SWITCH-TOGGLE, SMD, 6 PIN, SPDT, 2POS, ON-ON, ROHS	ITT INDUSTRIES/C&K DIVISION
	0	ea.	P3 (3VH30/1JN5)	DO NOT POPULATE OR PURCHASE	

ISL8023EVAL3Z, ISL8024EVAL3Z Board Layout

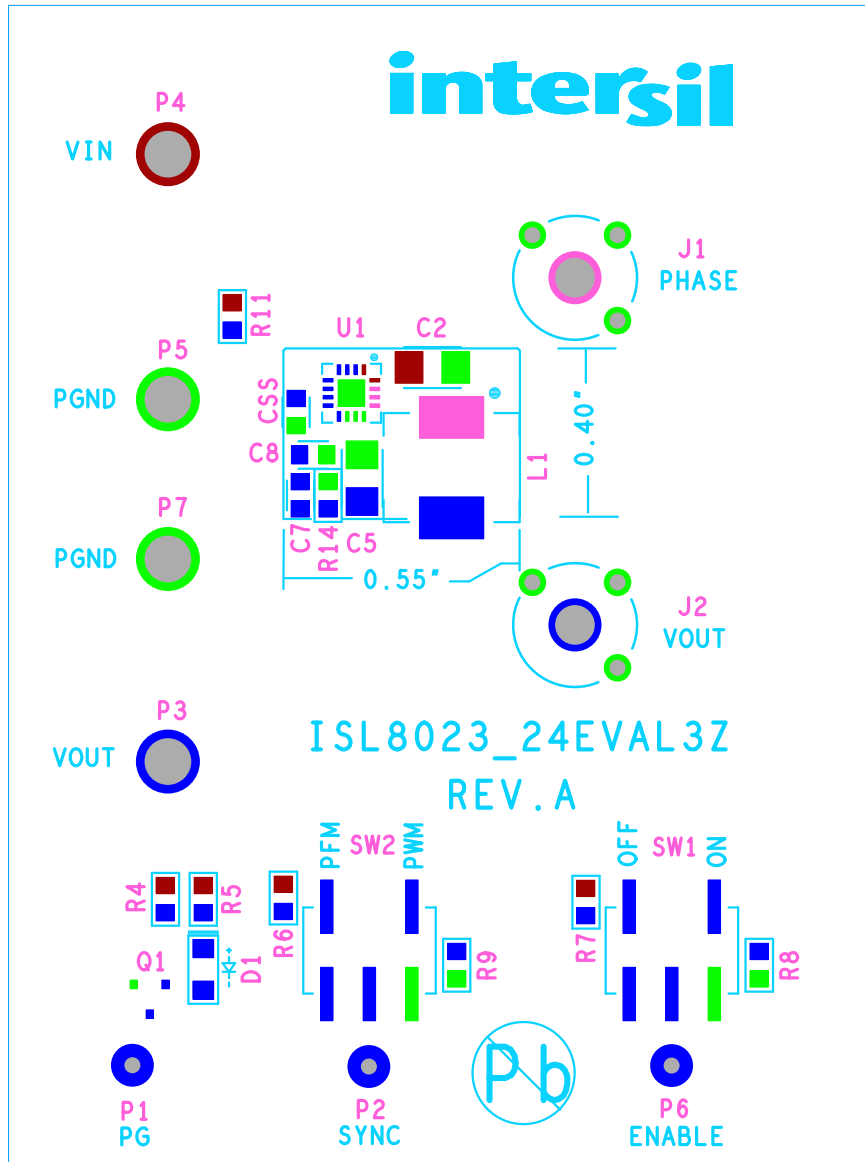

FIGURE 7. TOP LAYER COMPONENTS

ISL8023EVAL3Z, ISL8024EVAL3Z Board Layout (Continued)

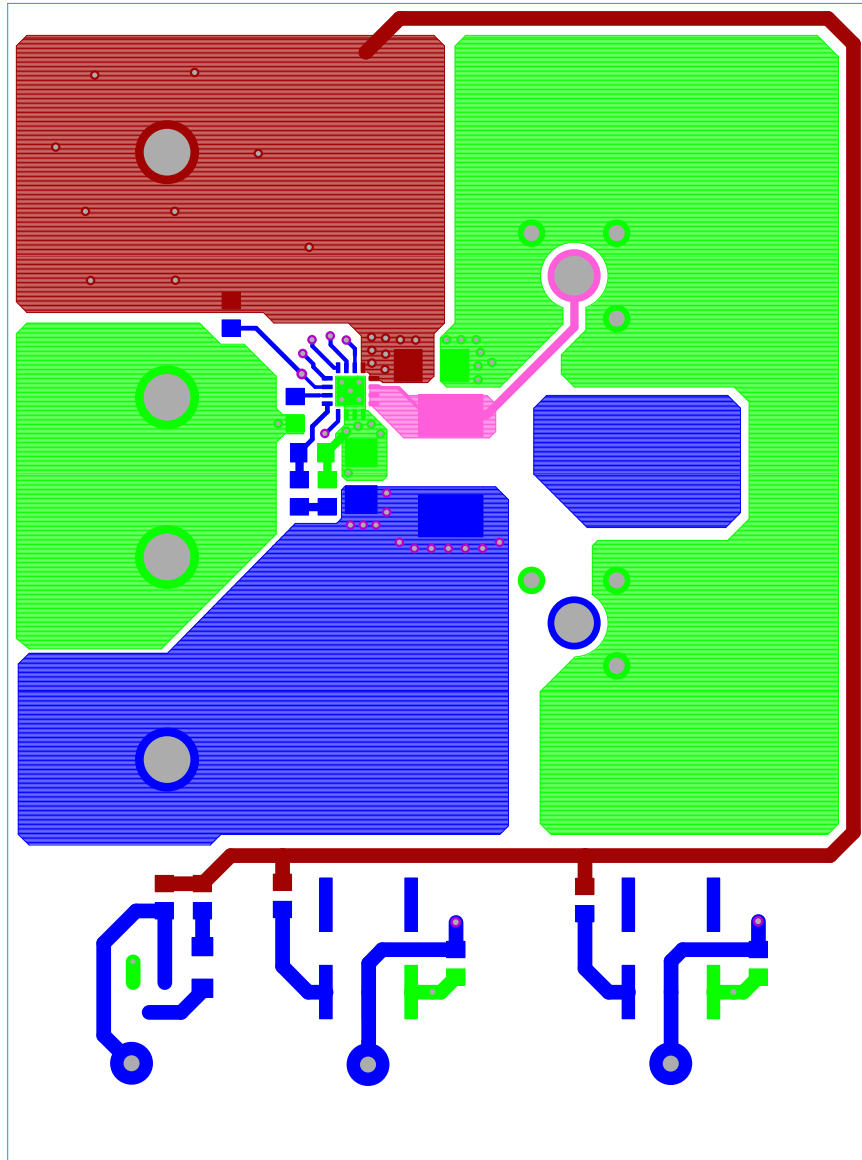

FIGURE 8. TOP LAYER ETCH

ISL8023EVAL3Z, ISL8024EVAL3Z Board Layout (Continued)

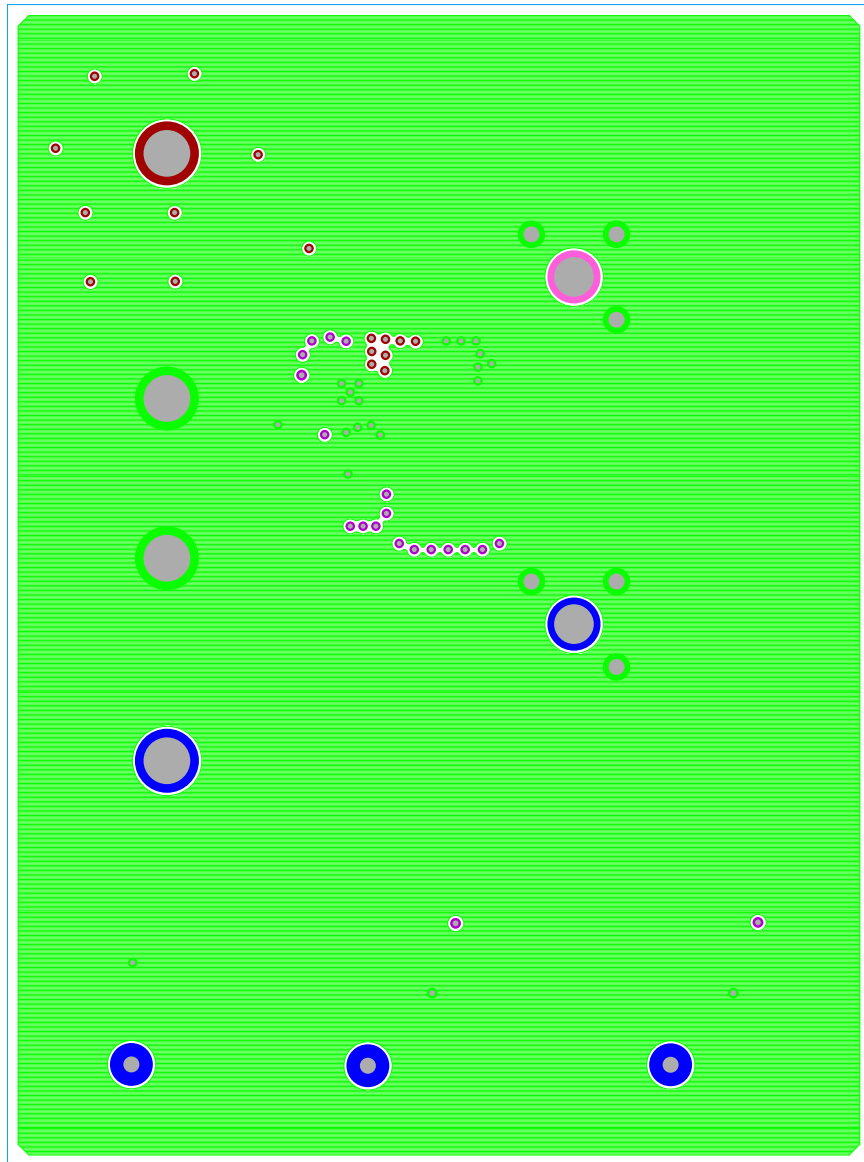

FIGURE 9. SECOND LAYER ETCH

ISL8023EVAL3Z, ISL8024EVAL3Z Board Layout (Continued)

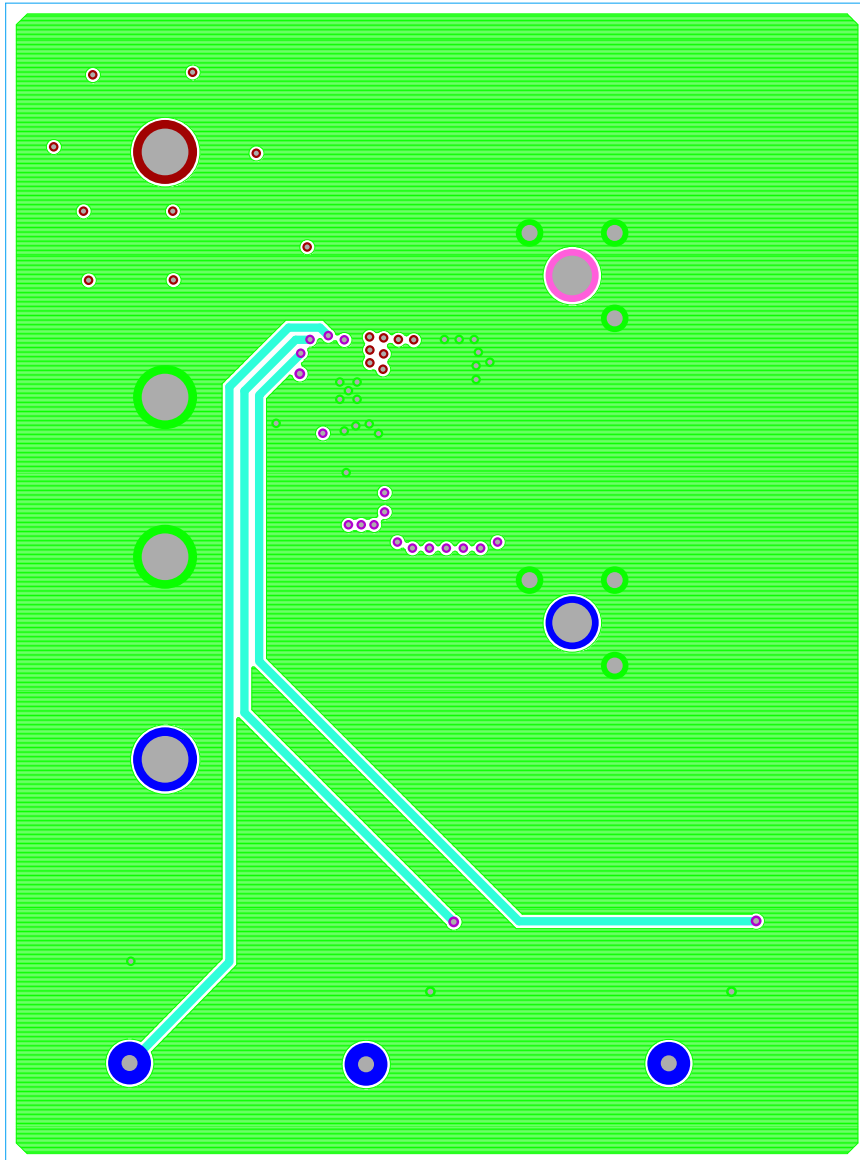

FIGURE 10. THIRD LAYER ETCH

ISL8023EVAL3Z, ISL8024EVAL3Z Board Layout (Continued)

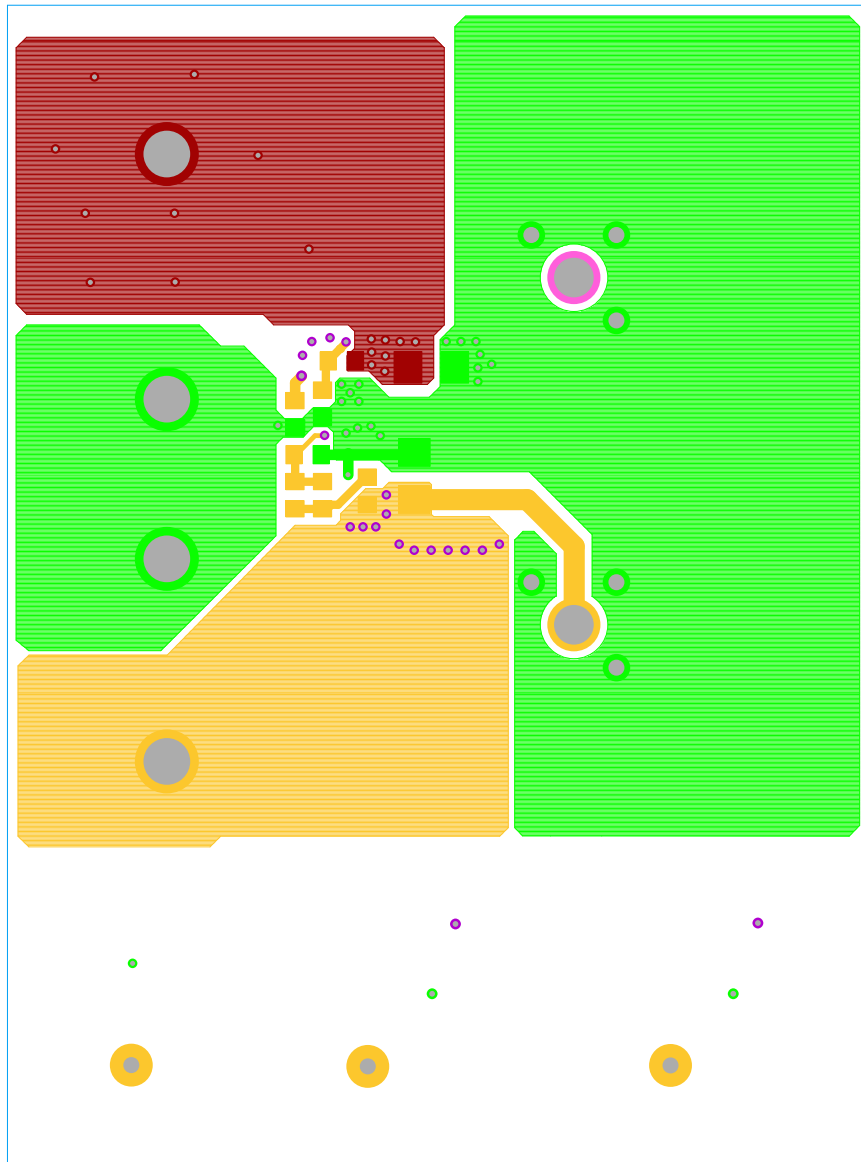

FIGURE 11. BOTTOM LAYER ETCH

ISL8023EVAL3Z, ISL8024EVAL3Z Board Layout (Continued)

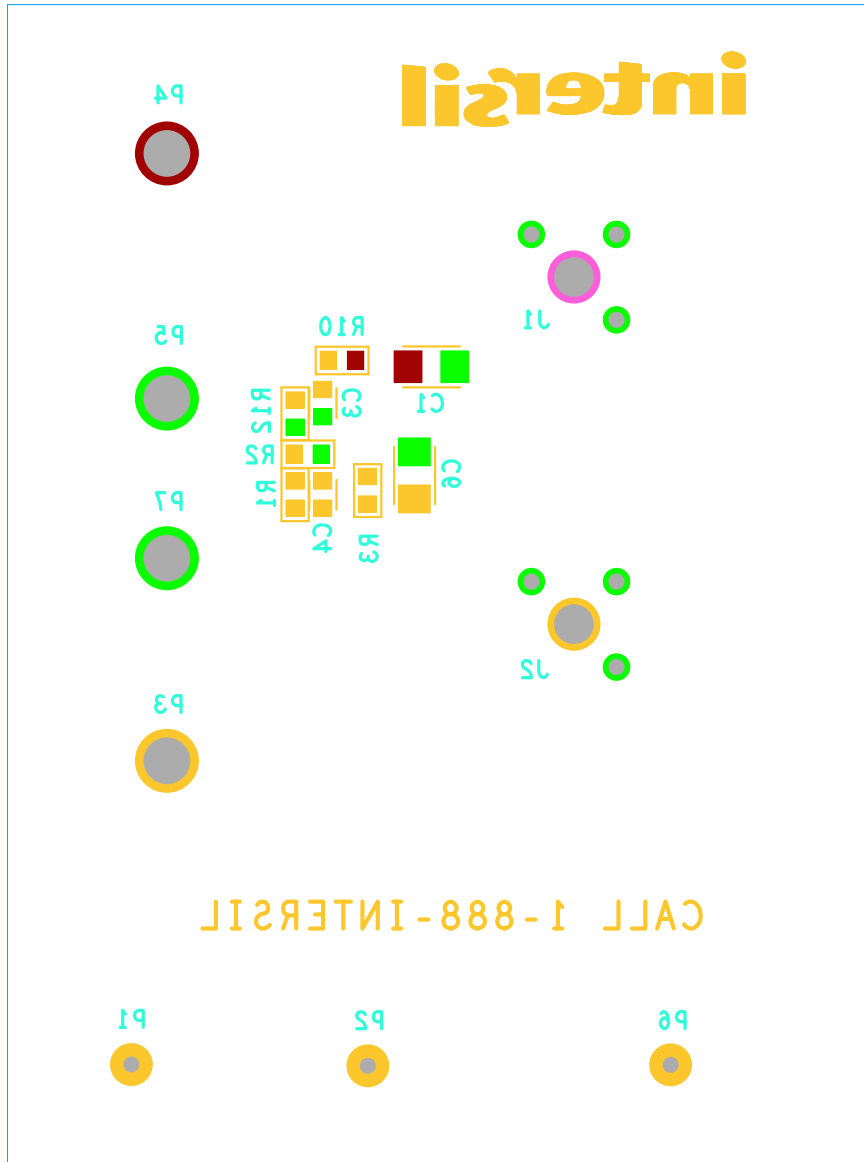

FIGURE 12. BOTTOM LAYER COMPONENTS