

## ISL8115DEMO1Z

Synchronous Buck Converter

AN1919  
Rev 2.00  
March 11, 2015

### Introduction

The ISL8115DEMO1Z is a compact reference design Synchronous Buck Converter (28.19mmx16.89mm) implementing Intersil's wide input range PWM controller ISL8115. Utilizing voltage mode control with input feed-forward, the ISL8115DEMO1Z maintains a constant loop gain for optimal transient response, especially for applications with a wide input voltage range. For a more detailed description of the ISL8115 functionality, refer to the [ISL8115](#) datasheet.

This user guide includes the test setup, typical performance waveforms, schematic, layout and bill of materials (BOM).

### Specifications

TABLE 1. DEMONSTRATION BOARD ELECTRICAL SPECIFICATIONS

| SPEC             | DESCRIPTION                             | MIN | TYP   | MAX | UNIT |
|------------------|---|-----|-------|-----|------|
| V <sub>IN</sub>  | Input voltage range                     | 16  | 24    | 36  | V    |
| V <sub>OUT</sub> | Output voltage                          |     | 5     |     | V    |
| I <sub>OUT</sub> | Output rated current                    |     | 10    |     | A    |
| I <sub>OC</sub>  | Overcurrent threshold                   |     | 13    |     | A    |
| f <sub>sw</sub>  | Switching frequency                     |     | 600   |     | kHz  |
| Input UVP        | Rising threshold                        |     | 15    |     | V    |
|                  | Falling threshold                       |     | 14.2  |     | V    |
| η                | Efficiency at 24V input full load (10A) |     | 90.12 |     | %    |



FIGURE 1. ISL8115DEMO1Z DEMONSTRATION BOARD

### Key Features

- Small, compact design
- Fast transient response
  - Voltage-mode PWM leading-edge modulation with nonlinear control
  - Input voltage feed-forward
- Integrated 5V high speed 4A MOSFET gate drivers
  - Internal bootstrap diode
- Oscillator programmable from 150kHz to 1.5MHz
  - Frequency synchronization to external clock signal
- Diode emulation mode for light load efficiency improvement
- Output OVP/UVP; OCP and OTP
- Adjustable soft-start
- Prebias start-up function
- Excellent output voltage regulation
  - 0.6V ±1.0% internal reference (-40°C~+125°C)
  - 0.6V ±0.7% internal reference (-40°C~+105°C)
  - Differential voltage sensing

### References

- [ISL8115](#) datasheet

### Ordering Information

| PART NUMBER   | DESCRIPTION                     |
|---------------|---------------------------------|
| ISL8115DEMO1Z | Demonstration Board for ISL8115 |

### Recommended Equipment

- Input power source up to 36V supply voltage with 125W power supply ability
- Electronic load with 100W power sinking ability
- Voltmeters and ammeters
- 100MHz quad-trace oscilloscope

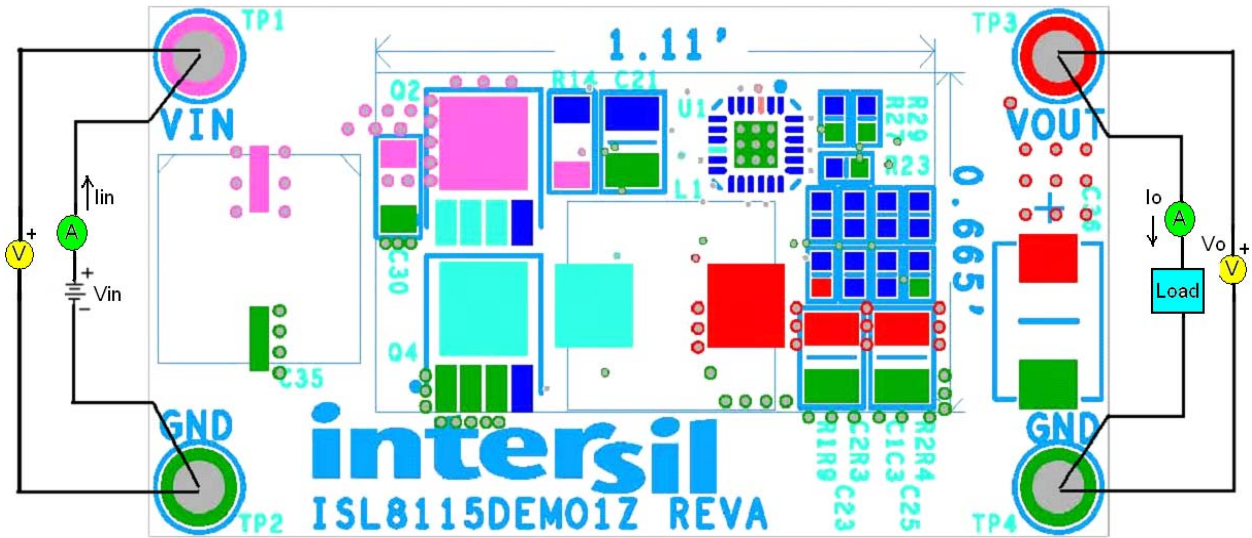

FIGURE 2. ISL8115DEMO1Z TEST SETUP

### Quick Test Setup

1. Ensure that the demonstration board is correctly connected to the power supply and the electronic load prior to applying any power. Refer to [Figure 2](#) for proper setup.
2. Set the input voltage to 24V, turn on the power supply and observe output voltage. The output voltage variation should be within 5%.
3. Adjust load current within 10A. The output voltage variation should be within 5%.
4. Use oscilloscope to observe output ripple voltage and phase node ringing. For accurate measurement, refer to [Figure 3](#) for proper setup.

### Probe Setup

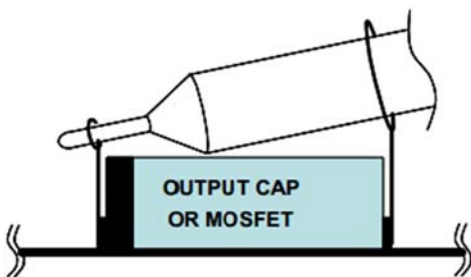

FIGURE 3. OSCILLOSCOPE PROBE SETUP

### Design Guide

The ISL8115DEMO1Z is optimized for 16V to 36V input voltage range. However, the evaluation board can be modified to support multiple applications due to the customer’s requirements. Refer to the [ISL8115](#) datasheet for detailed information.

TABLE 2. 12V APPLICATION

| V <sub>IN</sub> | R <sub>35</sub> |
|-----------------|-----------------|
| 12V             | 71.5k           |

Quick modify to 12V input application, [Table 2](#) can be followed. Some other modifications need to be made at the same time if best performance is expected.

### Output Voltage Adjustment

The output voltage can be set by the resistors R<sub>4</sub> and R<sub>1</sub>. In order to keep the existing compensation parameters unchanged, adjust R<sub>4</sub> to set the output voltage by the following [Equation 1](#):

$$R_4 = \frac{0.6V \times R_1}{V_{OUT} - 0.6V} \quad (EQ. 1)$$

The VMON monitors the output for UVP and OVP, the resistor divider value of R<sub>11</sub>/R<sub>8</sub> should be the same with the R<sub>1</sub>/R<sub>4</sub>.

### Synchronization

The ISL8115DEMOZ board can be synchronized with an external clock. Applying a clock signal (10% to 90% duty cycle) in the range of 150kHz to 1.5MHz to the FSET pin makes the internal frequency synchronized with the external clock. Please remove R<sub>27</sub> when the synchronized function is implemented.

# Typical Performance Curves

Unless otherwise specified, the input voltage is 28V.

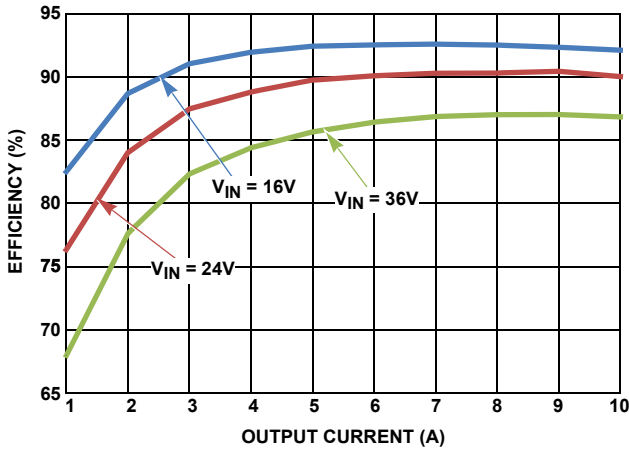

FIGURE 4. EFFICIENCY vs LOAD CURRENT AT CCM MODE

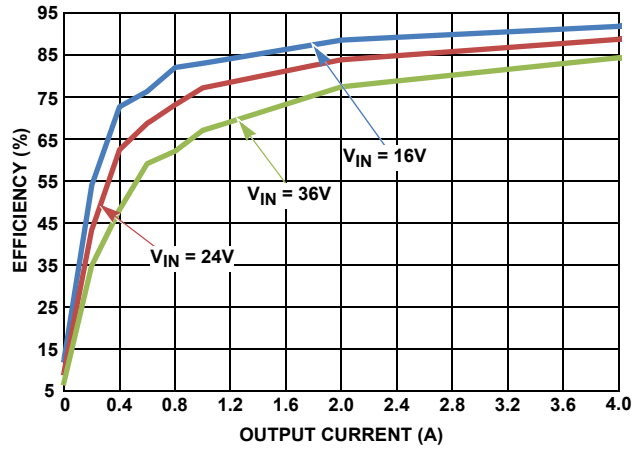

FIGURE 5. EFFICIENCY vs LOAD CURRENT AT DEM MODE

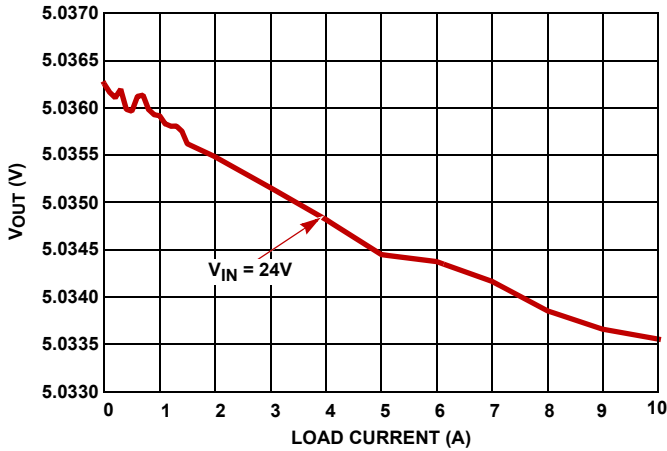

FIGURE 6. V<sub>OUT</sub> LOAD REGULATION AT CCM MODE

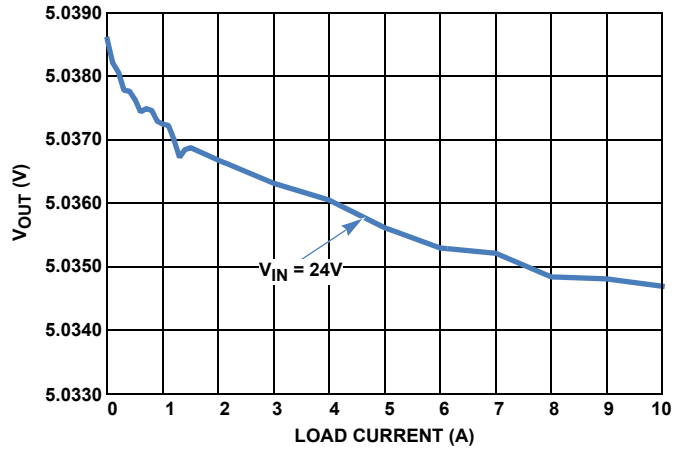

FIGURE 7. V<sub>OUT</sub> LOAD REGULATION AT DEM MODE

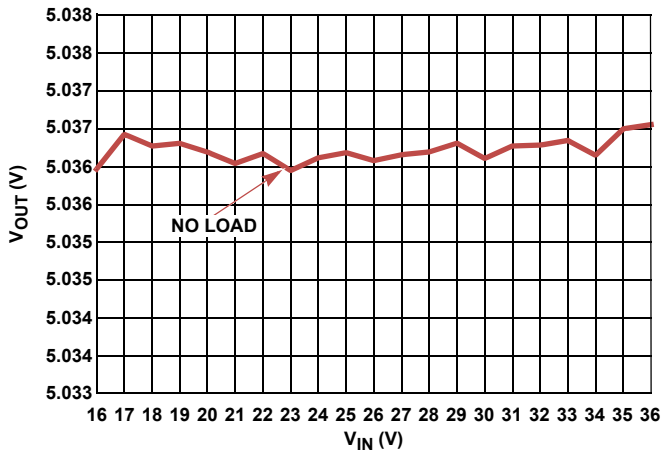

FIGURE 8. LINE REGULATION AT NO LOAD CCM MODE

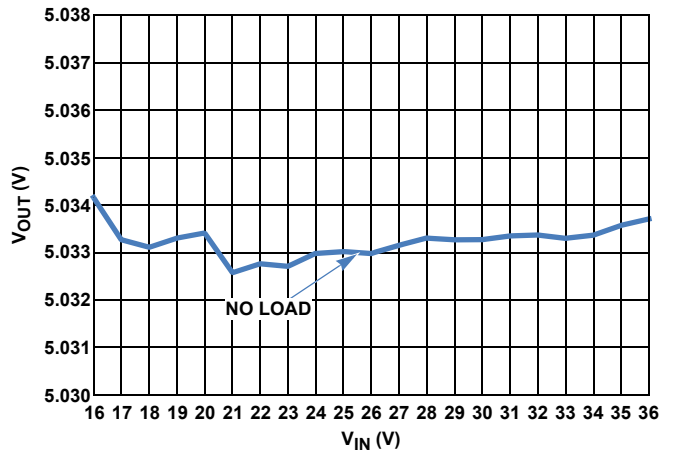

FIGURE 9. LINE REGULATION AT NO LOAD DEM MODE

# Typical Performance Curves

Unless otherwise specified, the input voltage is 28V. (Continued)

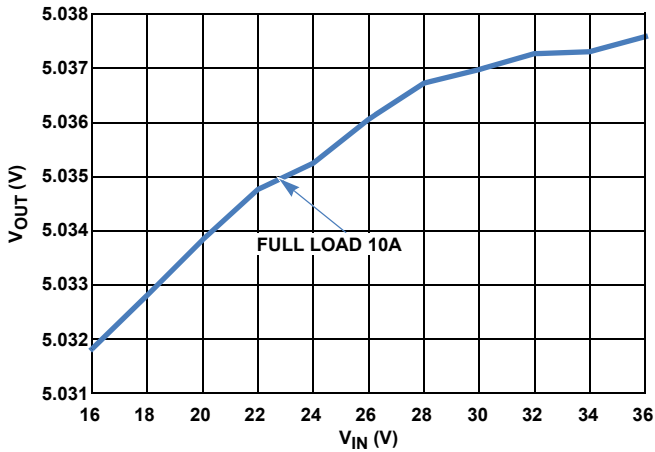

FIGURE 10. LINE REGULATION AT FULL LOAD CCM MODE

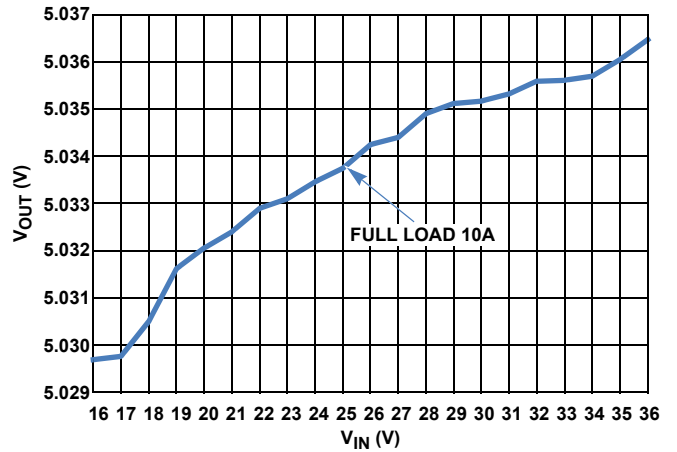

FIGURE 11. LINE REGULATION AT FULL LOAD DEM MODE

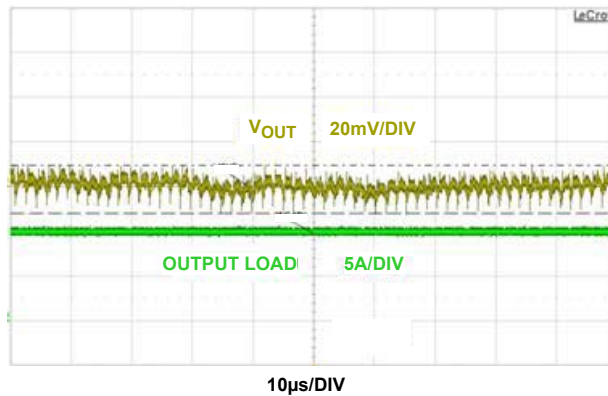

FIGURE 12. OUTPUT VOLTAGE RIPPLE AT 10A LOAD CONDITION

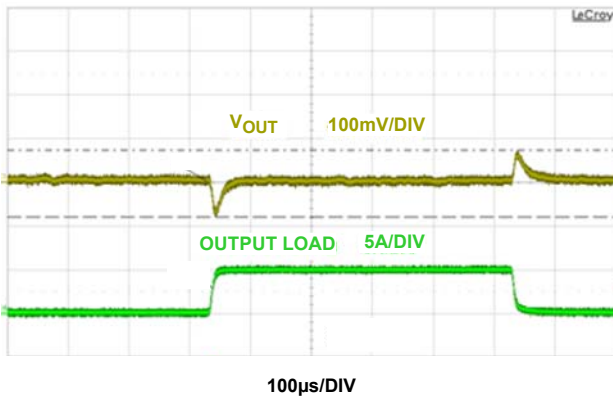

FIGURE 13. LOAD TRANSIENT 0A TO 5A; 2A/µs AT CCM

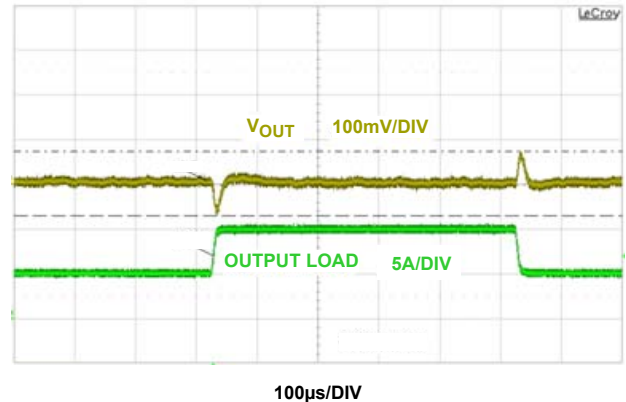

FIGURE 14. LOAD TRANSIENT 5A TO 10A; 2A/µs AT CCM

**Typical Performance Curves** Unless otherwise specified, the input voltage is 28V. (Continued)

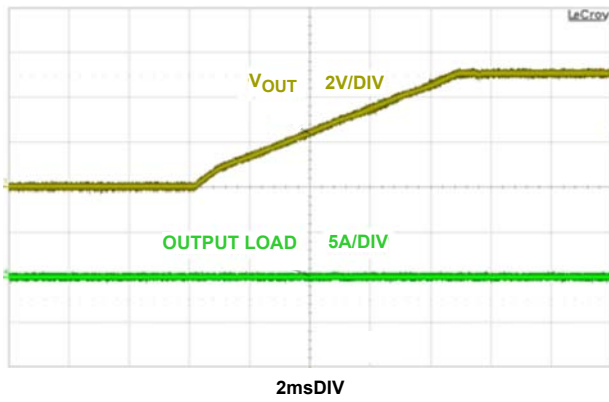

FIGURE 15. START-UP AT 0A LOAD CONDITION

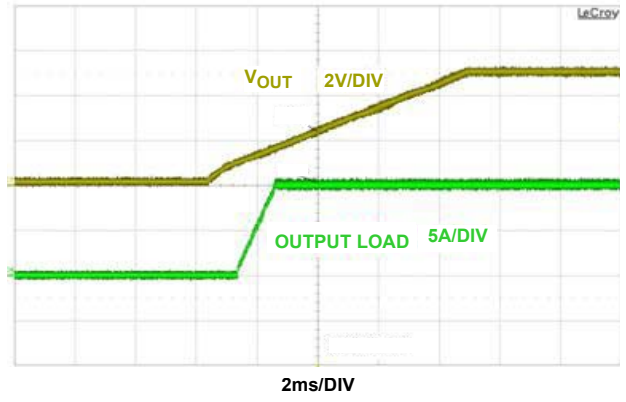

FIGURE 16. START-UP AT 10A LOAD CONDITION

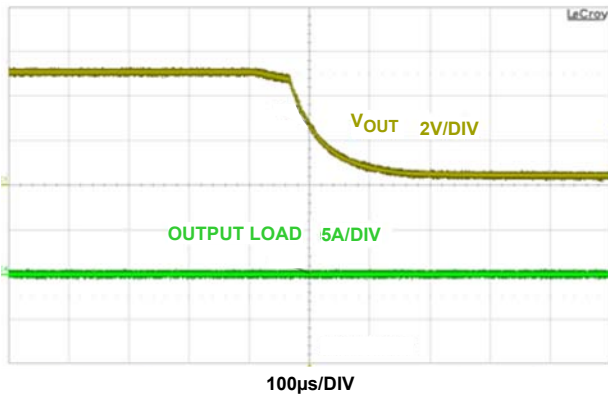

FIGURE 17. SHUTDOWN AT 0A LOAD CONDITION

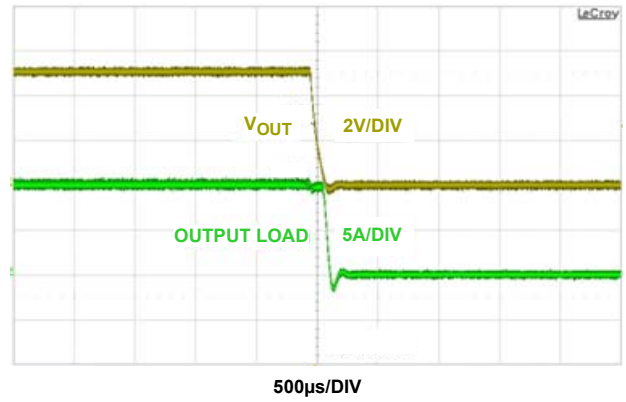

FIGURE 18. SHUTDOWN AT 10A LOAD CONDITION

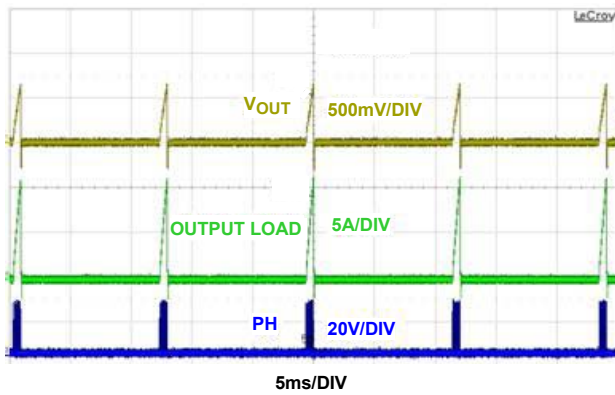

FIGURE 19. OVERCURRENT PROTECTION AT 12.6A LOAD

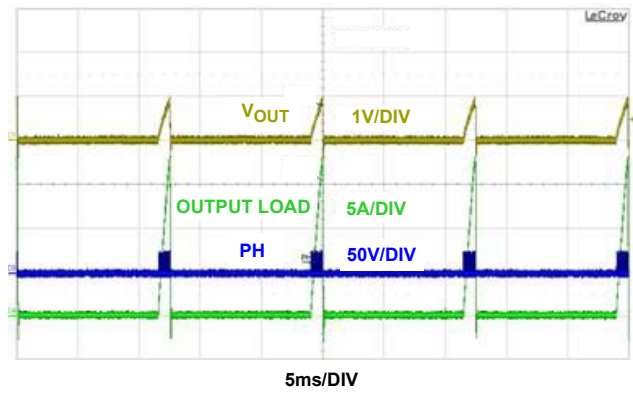

FIGURE 20. SHORT PROTECTION

# Schematic

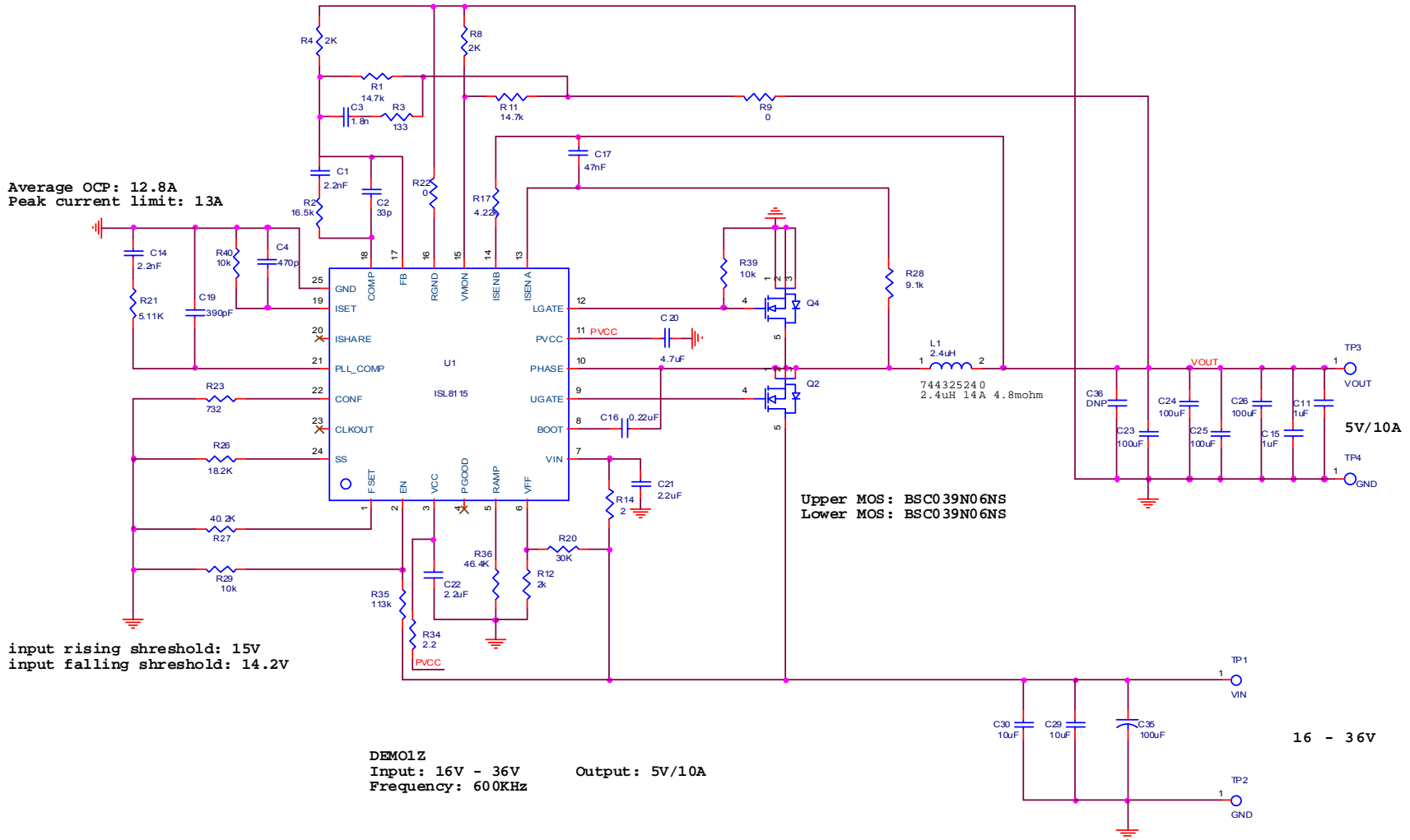

FIGURE 21. ISL8115DEMO1Z SCHEMATIC

## Bill of Materials

| ITEM | QTY | REFERENCE          | VALUE       | DESCRIPTION                      | MANUFACTURER | PART NUMBER         |
|------|-----|--------------------|-------------|----------------------------------|--------------|---------------------|
| 1    | 2   | C1, C14            | 2.2nF       | CAP CER 2200pF 25V 10% X7R 0402  | Generic      | Generic             |
| 2    | 1   | C2                 | 33pF        | CAP CER 33pF 50V 5% NPO 0402     | Generic      | Generic             |
| 3    | 1   | C3                 | 1.8nF       | CAP CER 1800pF 50V 10% X7R 0402  | Generic      | Generic             |
| 4    | 1   | C4                 | 470pF       | CAP CER 470pF 50V 10% X7R 0402   | Generic      | Generic             |
| 5    | 2   | C11, C15           | 1μF         | CAP CER 1μF 10V 10% X5R 0603     | Generic      | Generic             |
| 7    | 1   | C16                | 0.22μF      | CAP CER 0.22μF 16V 10% X7R 0402  | Generic      | Generic             |
| 8    | 1   | C17                | 47nF        | CAP CER 0.047μF 25V 10% X7R 0402 | Generic      | Generic             |
| 9    | 1   | C19                | 390pF       | CAP CER 390pF 50V 10% X7R 0402   | Generic      | Generic             |
| 10   | 1   | C20                | 4.7μF       | CAP CER 4.7μF 6.3V 10% X5R 0805  | Generic      | Generic             |
| 11   | 1   | C21                | 2.2μF       | CAP CER 2.2μF 50V 10% X7R 1210   | TDK          | C3225X7R1H225K      |
| 12   | 1   | C22                | 2.2μF       | CAP CER 2.2μF 6.3V 20% X5R 0603  | Generic      | Generic             |
| 13   | 4   | C23, C24, C25, C26 | 100μF       | CAP CER 100μF 6.3V 20% X5R 1210  | TDK          | C3225X5R0J107M250AC |
| 14   | 2   | C29, C30           | 10μF        | CAP CER 10μF 50V 10% X5R 1206    | TDK          | C3216X5R1H106K160AB |
| 15   | 1   | C35                | 100μF       | CAP ALUM 100μF 50V 20% SMD       | Nichicon     | PCV1H101MCL2GS      |
| 16   | 1   | C36                | DNP         | CAP 220μF 6.3V                   | Panasonic    | 6TPF220M5L          |
| 17   | 1   | L1                 | 2.4μH       | INDUCTOR POWER 2.4μH 31.5A SMD   | WE-Midcom    | 744325240           |
| 18   | 2   | Q2, Q4             | BSC039N06NS | MOSFET N-CH 60V 19A TDSO8        | Infineon     | BSC039N06NS         |
| 19   | 2   | R1, R11            | 14.7k       | RES 14.7kΩ 1/16W 1% 0402 SMD     | Generic      | Generic             |
| 20   | 1   | R2                 | 16.5k       | RES 16.5kΩ 1/16W 1% 0402 SMD     | Generic      | Generic             |
| 21   | 1   | R3                 | 133         | RES 133Ω 1/16W 1% 0402 SMD       | Generic      | Generic             |
| 22   | 3   | R4, R8, R12        | 2k          | RES 2.00kΩ 1/16W 1% 0402 SMD     | Generic      | Generic             |
| 23   | 2   | R9, R22            | 0           | RES 0.0Ω 1/16W JUMP 0402 SMD     | Generic      | Generic             |
| 24   | 1   | R14                | 2           | RES 2.00Ω 1/4W 1% 1206 SMD       | Generic      | Generic             |
| 25   | 1   | R17                | 4.22k       | RES 4.22kΩ 1/16W 1% 0402 SMD     | Generic      | Generic             |
| 26   | 1   | R20                | 30k         | RES 30kΩ 1/16W 1% 0402 SMD       | Generic      | Generic             |
| 27   | 1   | R21                | 5.11k       | RES 5.11kΩ 1/16W 1% 0402 SMD     | Generic      | Generic             |
| 28   | 1   | R23                | 732         | RES 732Ω 1/16W 1% 0402 SMD       | Generic      | Generic             |
| 29   | 1   | R26                | 18.2k       | RES 18.2kΩ 1/16W 1% 0402 SMD     | Generic      | Generic             |
| 30   | 1   | R27                | 40.2k       | RES 40.2kΩ 1/16W 1% 0402 SMD     | Generic      | Generic             |
| 31   | 1   | R28                | 9.1k        | RES 9.1kΩ 1/16W 1% 0402 SMD      | Generic      | Generic             |
| 32   | 3   | R29, R39, R40      | 10k         | RES 10kΩ 1/16W 1% 0402 SMD       | Generic      | Generic             |
| 33   | 1   | R34                | 2.2         | RES 2.2Ω 1/16W 1% 0402 SMD       | Generic      | Generic             |
| 34   | 1   | R35                | 113k        | RES 113kΩ 1/16W 1% 0402 SMD      | Generic      | Generic             |



## Assembly Drawing

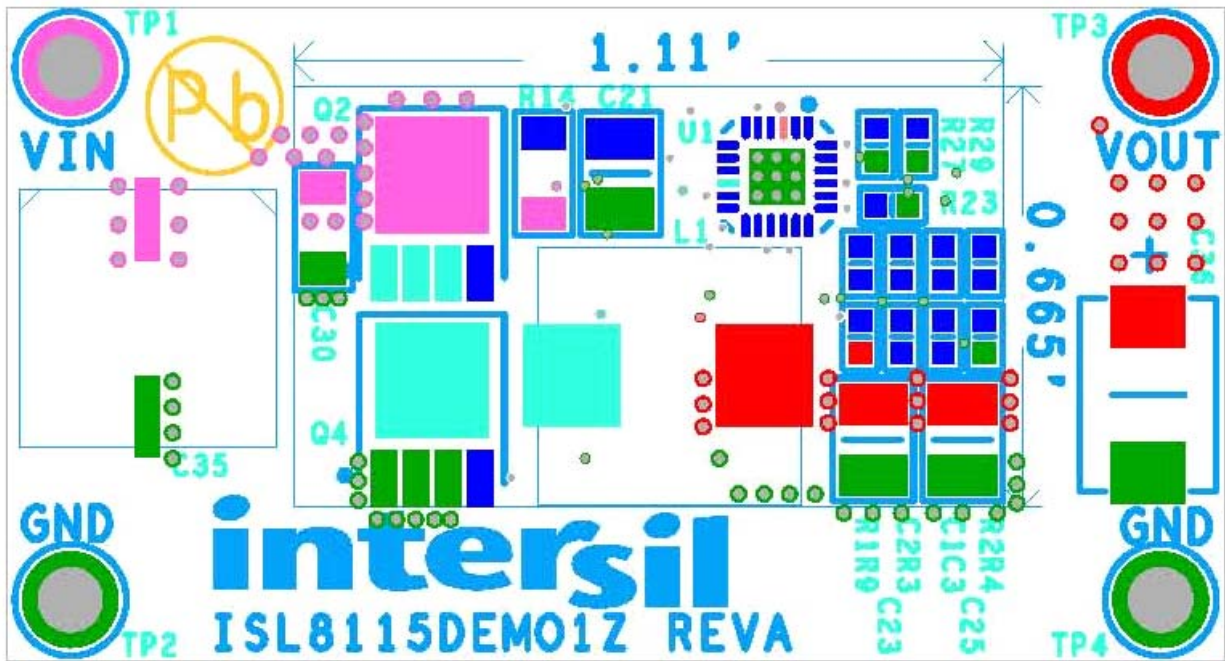

FIGURE 22. TOP

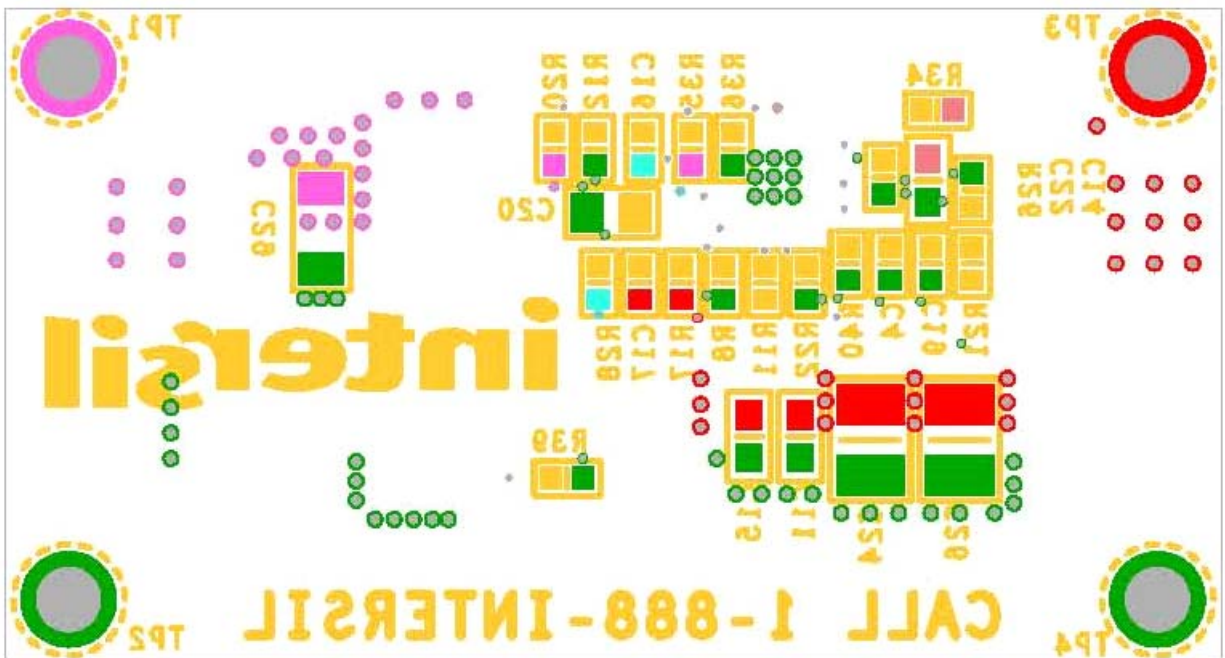

FIGURE 23. BOTTOM



# PCB Layout

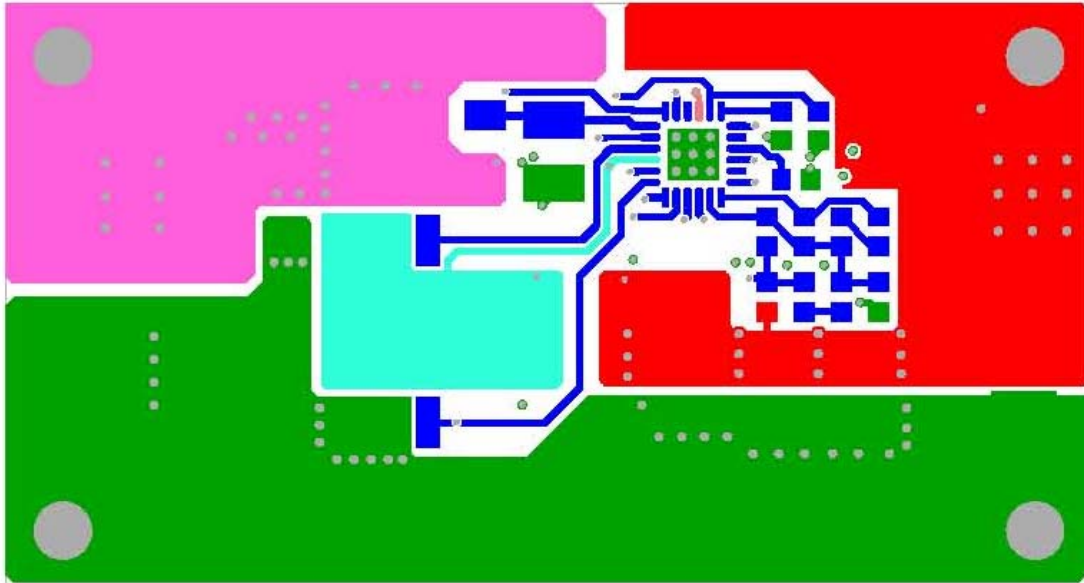

FIGURE 24. TOP LAYER

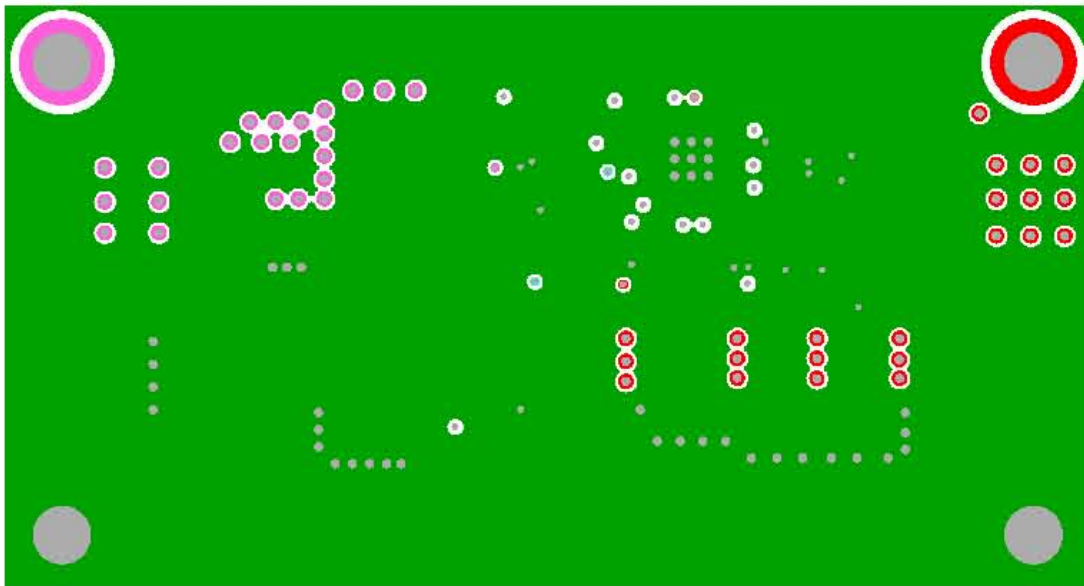

FIGURE 25. LAYER 2

## PCB Layout (Continued)

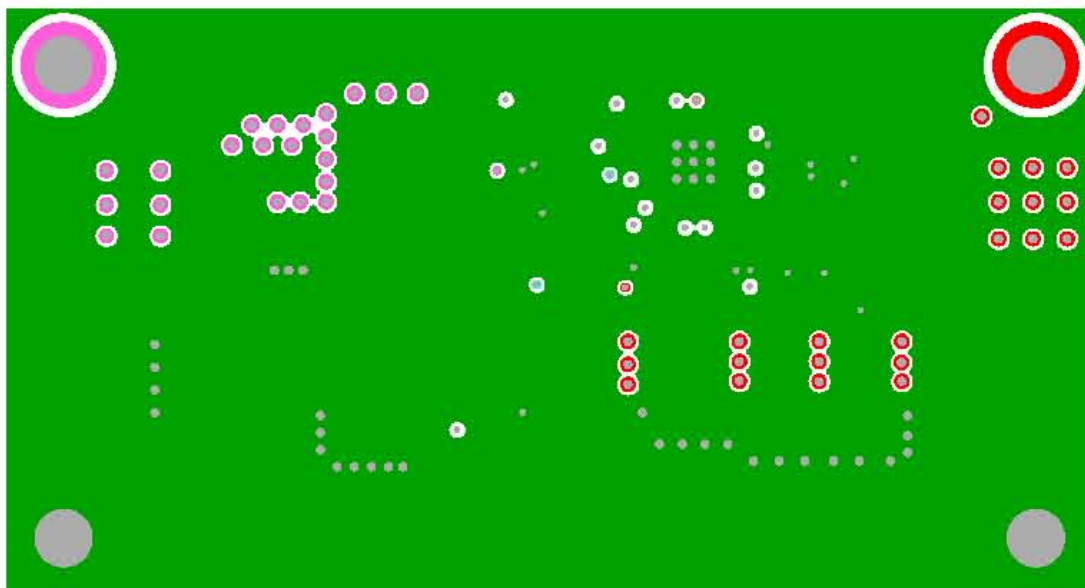

FIGURE 26. LAYER 3

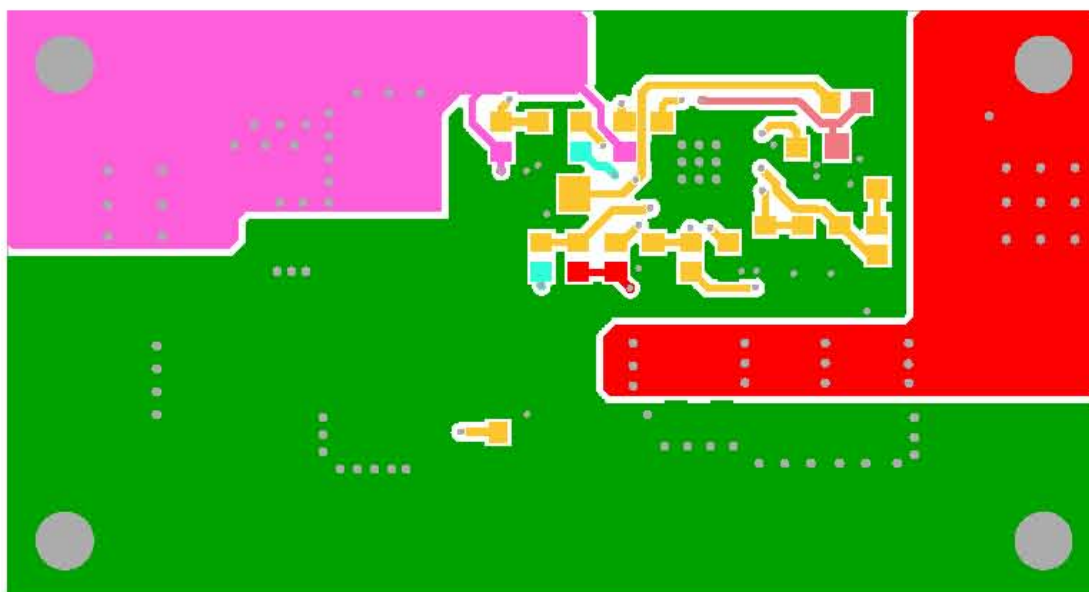

FIGURE 27. BOTTOM LAYER