

ISL8115EVAL2Z

Synchronous Buck Converter

AN1882
Rev 2.00
February 5, 2014

Introduction

ISL8115EVAL2Z is a Synchronous Buck Converter implementing Intersil's wide input range PWM controller ISL8115. Utilizing voltage mode control with input feed forward, the ISL8115EVAL2Z maintains a constant loop gain for optimal transient response, especially for applications with a wide input voltage range. For a more detailed description of the ISL8115 functionality, refer to the [ISL8115](#) data sheet.

This application note includes the test setup, typical performance waveforms, schematic, layout and bill of materials (BOM).

Evaluation Board Specifications

TABLE 1. EVALUATION BOARD ELECTRICAL SPECIFICATIONS

SPEC	DESCRIPTION	MIN	TYP	MAX	UNIT
V _{IN}	Board Input Range	25	28	36	V
V _{OUT}	Output Voltage		5		V
I _{OUT}	Output Rated Current		20		A
I _{OC}	Overcurrent Threshold		22		A
F _{SW}	Switch Frequency		220		kHz
Input UVP	Rising threshold		22.4		V
	Falling threshold		24.2		V
η	Efficiency at 50% load		92.53		%



FIGURE 1. ISL8115EVAL2Z EVALUATION BOARD

ISL8115 Key Features

- Wide V_{IN} range operation: 2.97V to 36V; up to 5.5V output and 30A load current per phase.
- Fast transient response
 - Voltage-mode PWM leading-edge modulation with non-linear control
 - Input voltage feed-forward
- Integrated 5V high speed 4A MOSFET gate drivers
 - Internal bootstrap diode
- Oscillator programmable from 150kHz to 1.5MHz
 - Frequency synchronization to external clock signal
- Diode emulation mode for light load efficiency improvement
- Output OVP/UVP; OCP and OTP
- Power-good open drain output
- Adjustable soft-start
- Pre-bias start-up function
- Excellent output voltage regulation
 - 0.6V ±1.0% internal reference (-40°C ~ +125°C)
 - 0.6V ±0.7% internal reference (-40°C ~ +105°C)
 - Differential voltage sensing

Applications

- Power supply for datacom/telecom and POL
- Wide input voltage range buck regulators
- High current density power supplies RF power amplifier bias compensation

Recommended Equipment

- Input power source up to 36V supply voltage with 125W power supply ability.
- Electronic load with 100W power sinking ability
- Voltmeters and ammeters
- 100MHz quad-trace oscilloscope

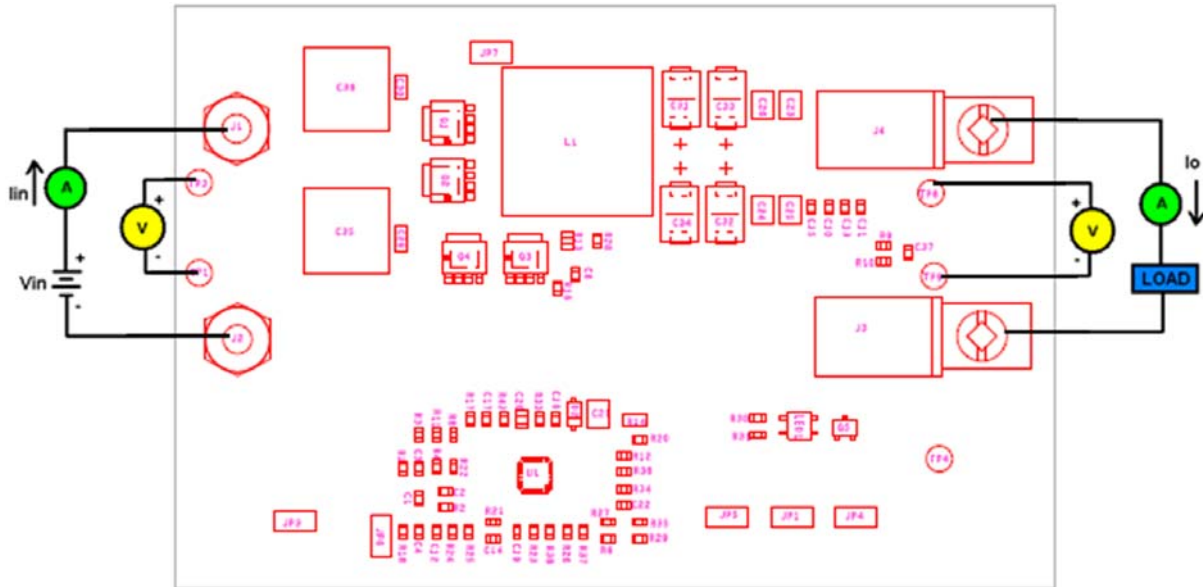

FIGURE 2. ISL8115EVAL2Z TEST SET-UP

Quick Test Setup

1. Ensure that the Evaluation board is correctly connected to the power supply and the electronic load prior to applying any power. Please refer to Figure 2 for proper set-up.
2. Set the input voltage to 28V, turn on the power supply and observe output voltage. The output voltage should variation should be within 5%.
3. Adjust load current within 20A. The output voltage variation should be within 5%.
4. Use oscilloscope to observe output ripple voltage and phase node ringing. For accurate measurement, please refer to Figure 3 for proper set-up.

Note: Test points TP1; TP3; TP8; TP9 are for voltage measurement only. Do not allow high current through these test points.

Probe Set-up

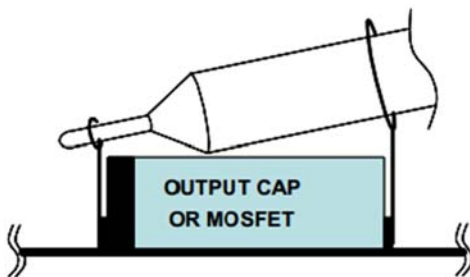

FIGURE 3. OSCILLOSCOPE PROBE SET-UP

Design Guide

The ISL8115EVAL2Z is optimized for 25V to 36V input voltage range. However, the evaluation board can be modified to support multiple applications due to the customer requirements. Please refer to the datasheet for the detailed information.

Output Voltage Adjustment

The output voltage can be set by the resistor R4, R1. In order to keep the existing compensation parameters unchanged, adjust R4 to set the output voltage by the following Equation 1:

$$R4 = \frac{0.6V \times R1}{V_{out} - 0.6V} \tag{EQ. 1}$$

VMON monitors the output for UVP and OVP, the resistor divider value of R11/R8 should be the same with the R1/R4.

Synchronization

ISL8115EVAL2Z board can be synchronized with an external clock. Apply a clock signal (10% to 90% duty cycle) in the range of 150kHz to 1.5MHz to the FSET pin makes the internal frequency synchronized with the external clock. Please remove R27 when the sync function is implemented.

Typical Performance Curves Unless otherwise specified, the input voltage is 28V.

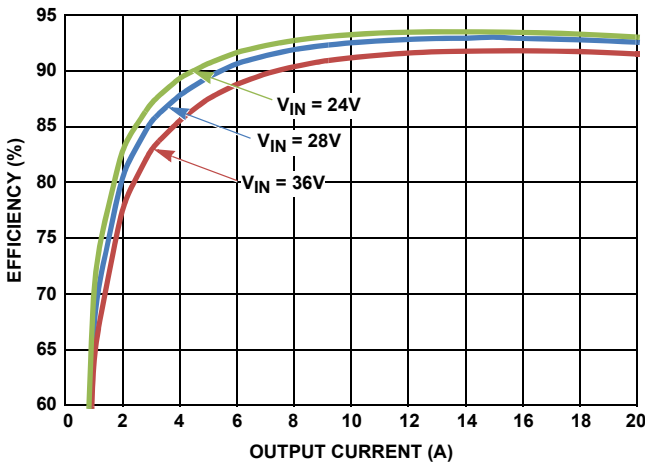

FIGURE 4. EFFICIENCY vs LOAD CURRENT AT CCM MODE

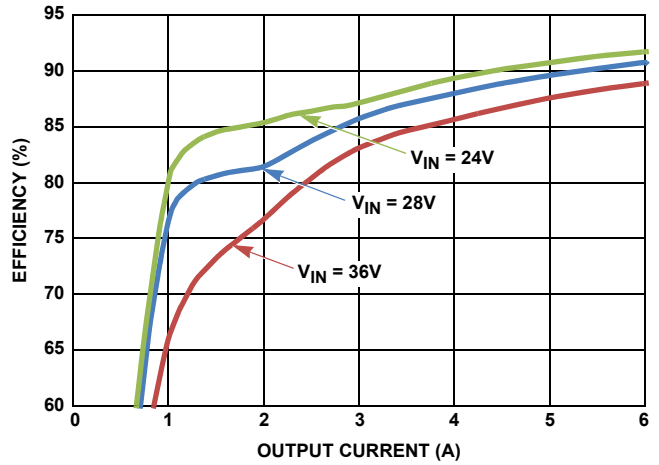

FIGURE 5. EFFICIENCY vs LOAD CURRENT AT DEM MODE

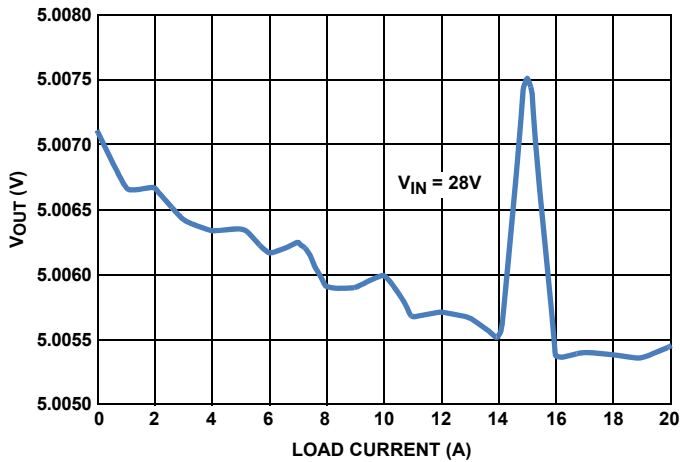

FIGURE 6. V_{OUT} LOAD REGULATION AT CCM MODE

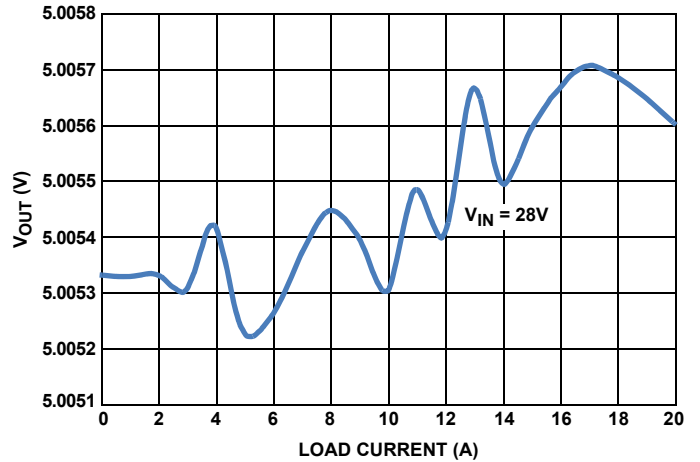

FIGURE 7. V_{OUT} LOAD REGULATION AT DEM MODE

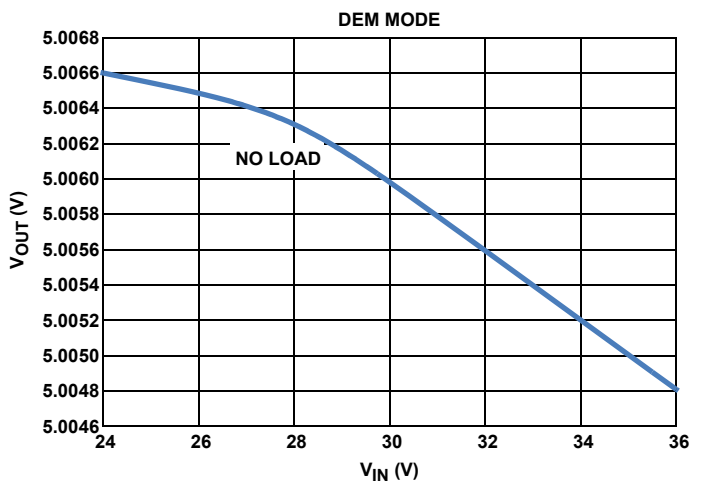
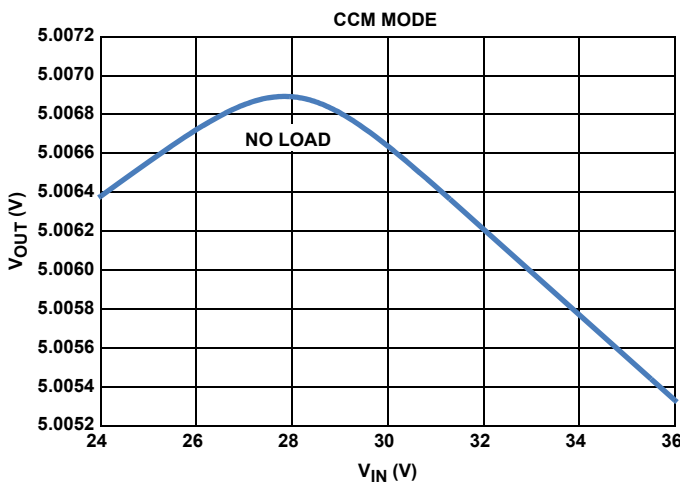

FIGURE 8. LINE REGULATION AT NO LOAD CONDITION

Typical Performance Curves Unless otherwise specified, the input voltage is 28V. (Continued)

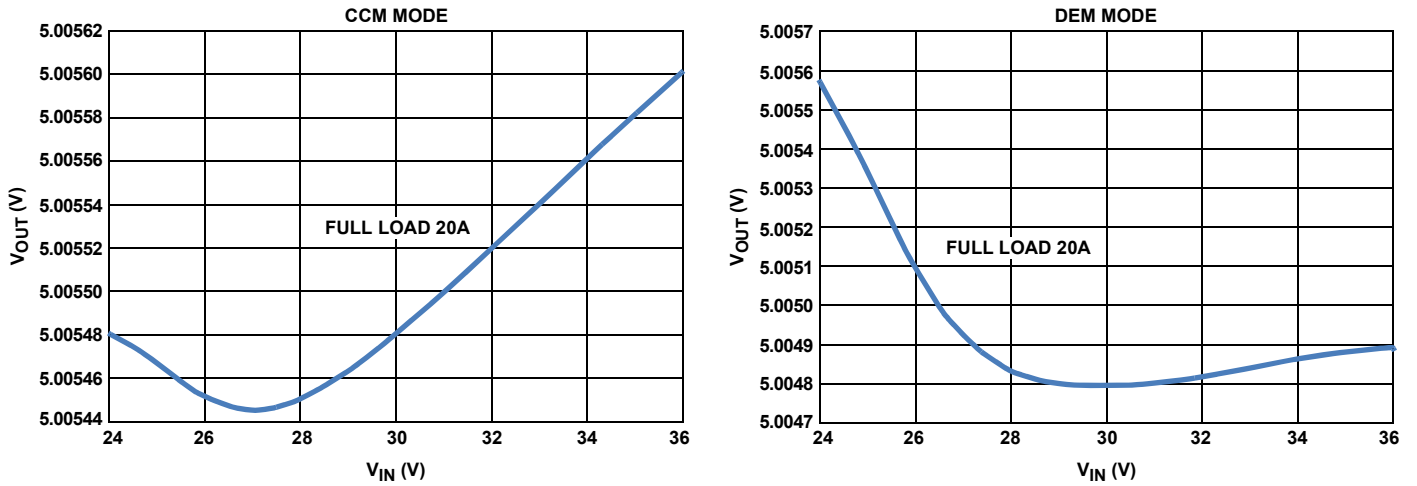

FIGURE 9. LINE REGULATION AT FULL LOAD CONDITION

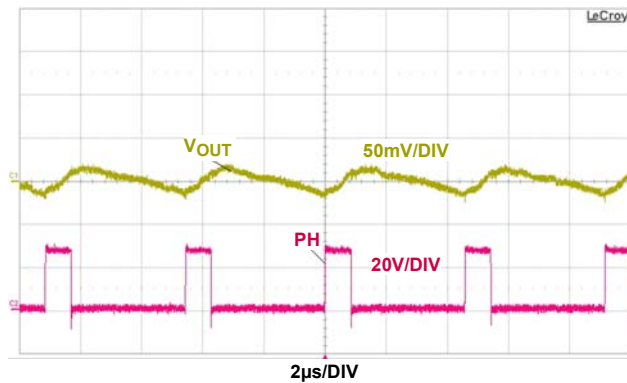

FIGURE 10. OUTPUT VOLTAGE RIPPLE AT 20A LOAD CONDITION

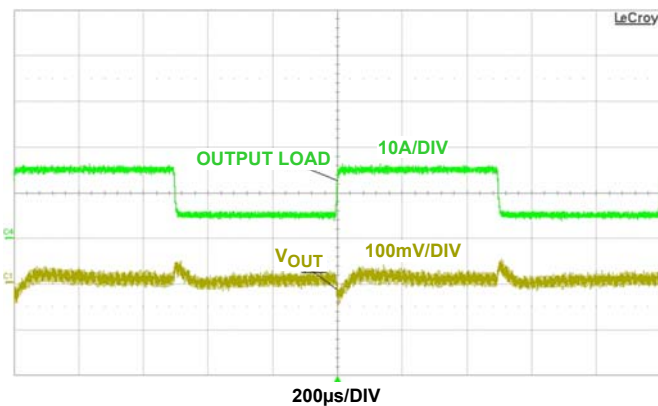

FIGURE 11. 5A-15A; 2A/µs AT CCM MODE

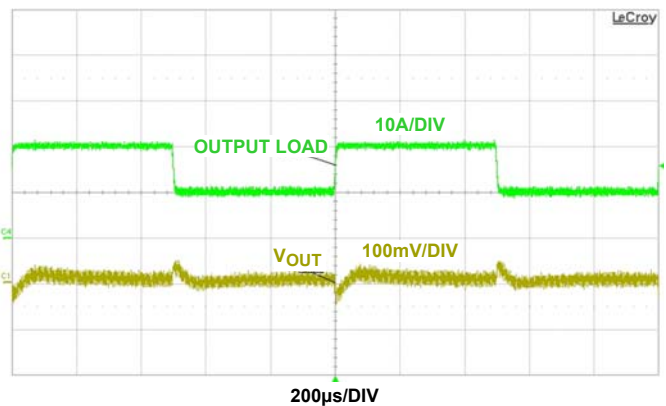

FIGURE 12. 10A -20A; 2A/µs AT CCM MODE

Typical Performance Curves Unless otherwise specified, the input voltage is 28V. (Continued)

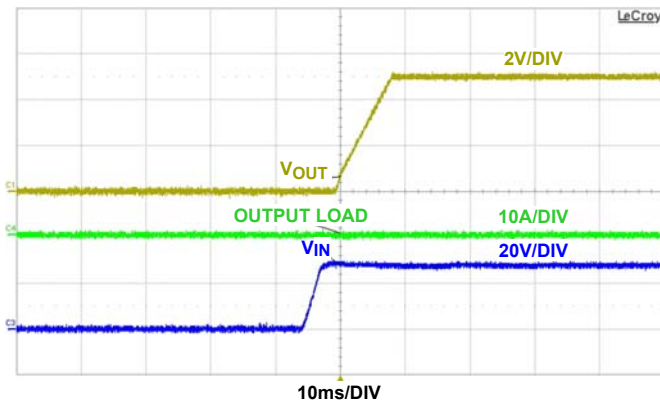

FIGURE 13. START-UP AT 0A LOAD CONDITION

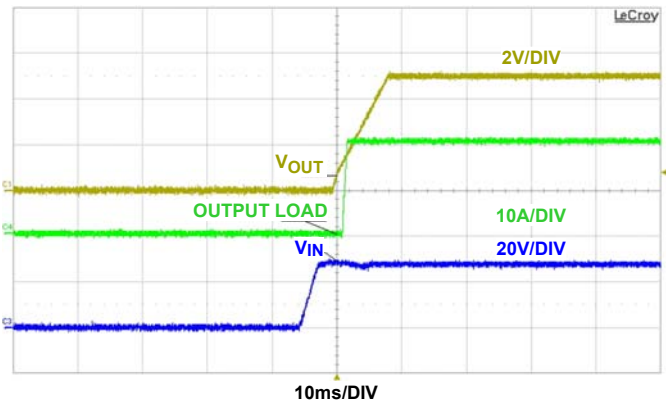

FIGURE 14. START-UP AT 20A LOAD CONDITION

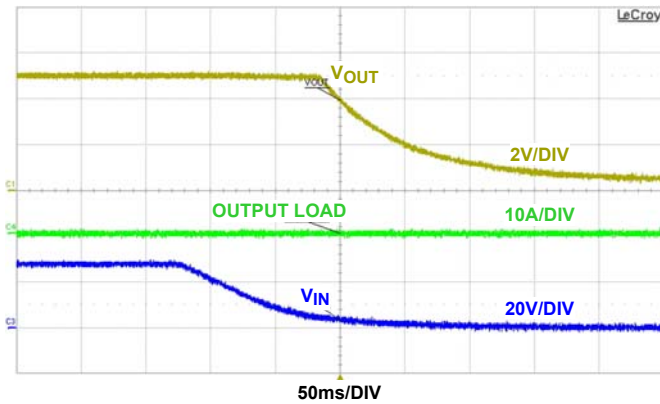

FIGURE 15. SHUTDOWN AT 0A LOAD CONDITION

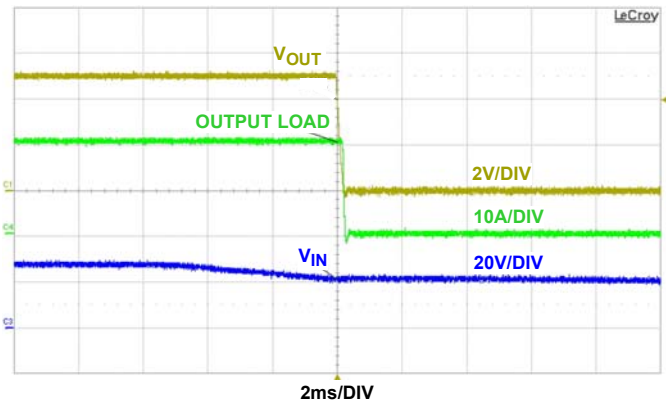

FIGURE 16. SHUTDOWN AT 20A LOAD CONDITION

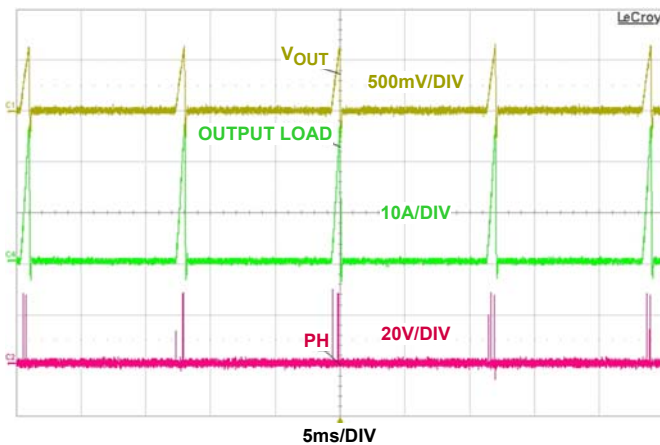

FIGURE 17. OCP AT 27A LOAD

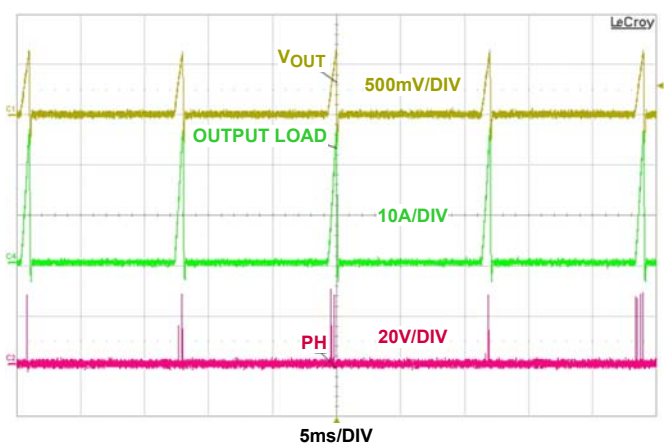
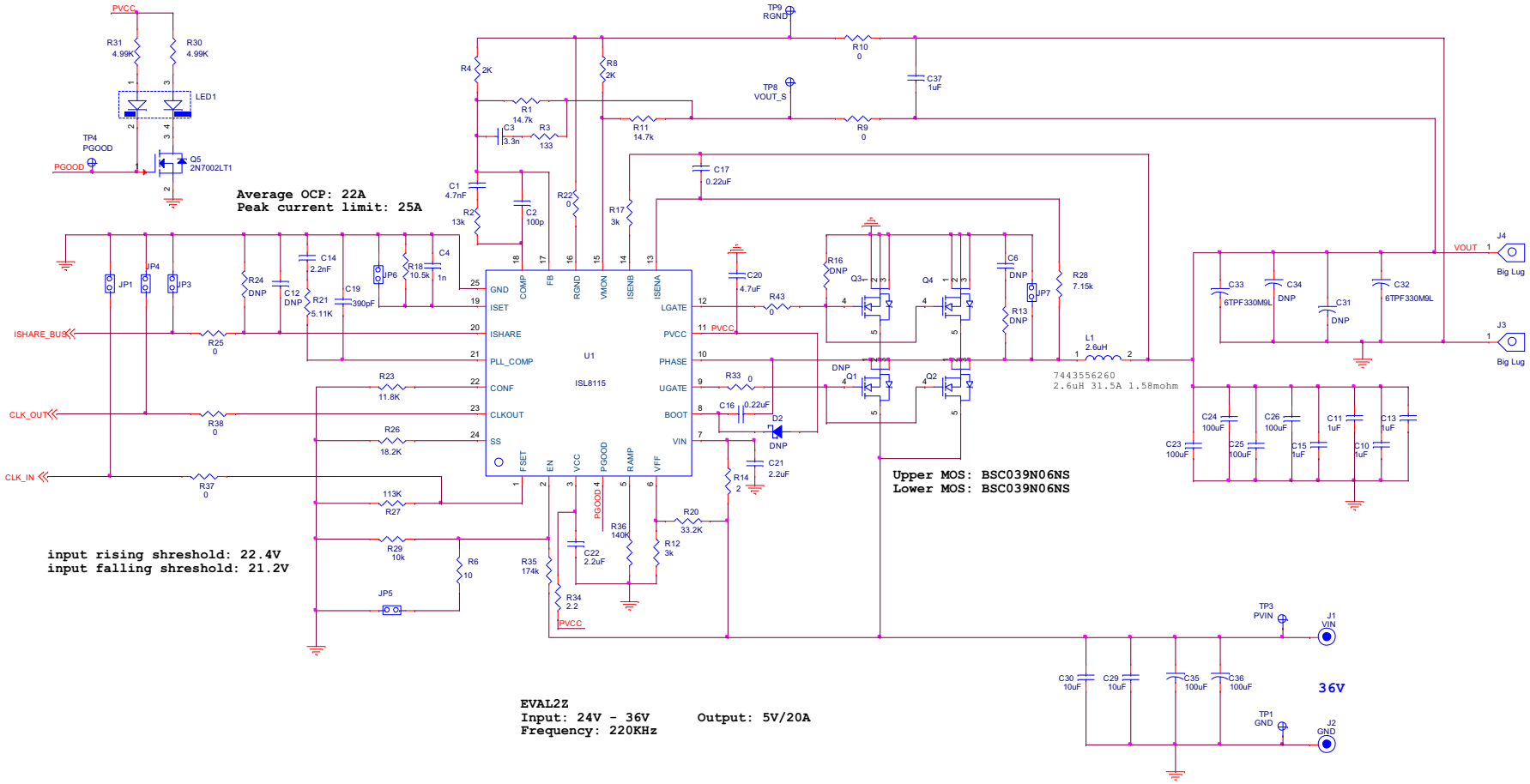

FIGURE 18. SHORT PROTECTION

Schematic



Bill of Materials

QTY	REFERENCE	VALUE	DESCRIPTION	PART #	VENDOR
1	C1	4.7nF	CAP CER 4700pF 50V 10% X7R 0603	Generic	Generic
1	C2	100p	CAP CER 100pF 50V 5% NPO 0603	Generic	Generic
1	C3	3.3n	CAP CER 3300pF 50V 10% X7R 0603	Generic	Generic
1	C4	1n	CAP CER 1000pF 50V 5% NPO 0603	Generic	Generic
5	C6, C12, R13, R16, R24	DNP			
5	C10, C11, C13, C15, C37	1µF	CAP CER 1µF 10V 10% X5R 0603	Generic	Generic
1	C14	2.2nF	CAP CER 2200pF 50V 10% NPO 0603	Generic	Generic
2	C16, C17	0.22µF	CAP CER 0.22µF 16V 10% X7R 0603	Generic	Generic
1	C19	390pF	CAP CER 390pF 50V 5% NPO 0603	Generic	Generic
1	C20	4.7µF	CAP CER 4.7µF 6.3V 10% X5R 0805	Generic	Generic
1	C21	2.2µF	CAP CER 2.2µF 25V 10% X7R 1210	C3225X7R1E225K/1.60	TDK
1	C22	2.2µF	CAP CER 2.2µF 6.3V 20% X5R 0603	Generic	Generic
4	C23, C24, C25, C26	100µF	CAP CER 100µF 6.3V 20% X5R 1210	C3225X5R0J107M250AC	TDK
2	C29, C30	10µF	CAP CER 10µF 50V 10% X5R 1206	C3216X5R1H106K160AB	TDK
2	C31, C34	DNP	CAP TANT 330µF 6.3V 20% 2917	6TPF330M9L	Panasonic
2	C32, C33	6TPF330M9L	CAP TANT 330µF 6.3V 20% 2917	6TPF330M9L	Panasonic
2	C35, C36	100µF	CAP ALUM 100µF 50V 20% SMD	PCV1H101MCL2GS	nichicon
1	D2	DNP	DIODE SCHOTTKY 40V SOD123		
4	JP1, JP3, JP4, JP5	Jumper	JUMPER PLUG 2POS DOUBLE ROW	XG8T-0231	Omron
2	JP6, JP7	DNP	JUMPER PLUG 2POS DOUBLE ROW		
1	J1	VIN	POST BINDING BANANA INSULATED RE	111-0707-001	Johnson Components
1	J2	GND	POST BINDING BANANA INSULATED BL	111-0703-001	Johnson Components
2	J3, J4	Big Lug	CONN- Big Lug TERMINAL POST	KPA8CTP	Burndy
1	LED1	LXA3025IGC-TR	LED	LNJ162C3XRA	Panasonic
1	L1	2.6µH	INDUCTOR POWER 2.6µH 31.5A SMD	7443556260	WE-Midcom
1	Q1	DNP	MOSFET N-CH 60V 19A TDSO8		
3	Q2, Q3, Q4	BSC039N06NS	MOSFET N-CH 60V 19A TDSO8	BSC039N06NS	
1	Q5	2N7002LT1	MOSFET N-CH 60V 115MA SOT-23	2N7002LT1	ON Semiconductor
2	R1, R11	14.7k	RES 14.7kΩ 1/10W 1% 0603 SMD	Generic	Generic
1	R2	13k	RES 13.0kΩ 1/10W 1% 0603 SMD	Generic	Generic
1	R3	133	RES 133Ω 1/10W 1% 0603 SMD	Generic	Generic
2	R4, R8	2k	RES 2.00kΩ 1/10W 1% 0603 SMD	Generic	Generic
1	R6	10	RES 10.0Ω 1/10W 1% 0603 SMD	Generic	Generic
8	R9, R10, R22, R25, R33, R37, R38, R43	0	RES 0.0Ω 1/10W JUMP 0603 SMD	Generic	Generic
2	R12, R17	3k	RES 3.00kΩ 1/10W 1% 0603 SMD	Generic	Generic
1	R14	2	RES 2.00Ω 1/4W 1% 1206 SMD	Generic	Generic
1	R18	10.5k	RES 10.5kΩ 1/10W 1% 0603 SMD	Generic	Generic
1	R20	33.2k	RES 33.2kΩ 1/10W 1% 0603 SMD	Generic	Generic
1	R21	5.11k	RES 5.11kΩ 1/10W 1% 0603 SMD	Generic	Generic

Bill of Materials (Continued)

QTY	REFERENCE	VALUE	DESCRIPTION	PART #	VENDOR
1	R23	11.8k	RES 11.8kΩ 1/10W 1% 0603 SMD	Generic	Generic
1	R26	18.2k	RES 18.2kΩ 1/10W 1% 0603 SMD	Generic	Generic
1	R27	113k	RES 113kΩ 1/10W 1% 0603 SMD	Generic	Generic
1	R28	7.15k	RES 7.15kΩ 1/10W 1% 0603 SMD	Generic	Generic
1	R29	10k	RES 10kΩ 1/10W 1% 0603 SMD	Generic	Generic
2	R30, R31	4.99K	RES 4.99kΩ 1/10W 1% 0603 SMD	Generic	Generic
1	R34	2.2	RES 2.2Ω 1/10W 1% 0603 SMD	Generic	Generic
1	R35	174k	RES 174kΩ 1/10W 1% 0603 SMD	Generic	Generic
1	R36	140k	RES 140kΩ 1/10W 1% 0603 SMD	Generic	Generic
1	TP1	GND	Test point	SPCJ-123-01	Jolo
1	TP3	PVIN	Test point	SPCJ-123-01	Jolo
1	TP4	PGOOD	Test point	SPCJ-123-01	Jolo
1	TP8	VOUT_S	Test point	SPCJ-123-01	Jolo
1	TP9	RGND	Test point	SPCJ-123-01	Jolo
1	U1	ISL8115	Sync Buck PWM Controller 24Ld QFN	ISL8115FRTZ	Intersil

Assembly Drawing

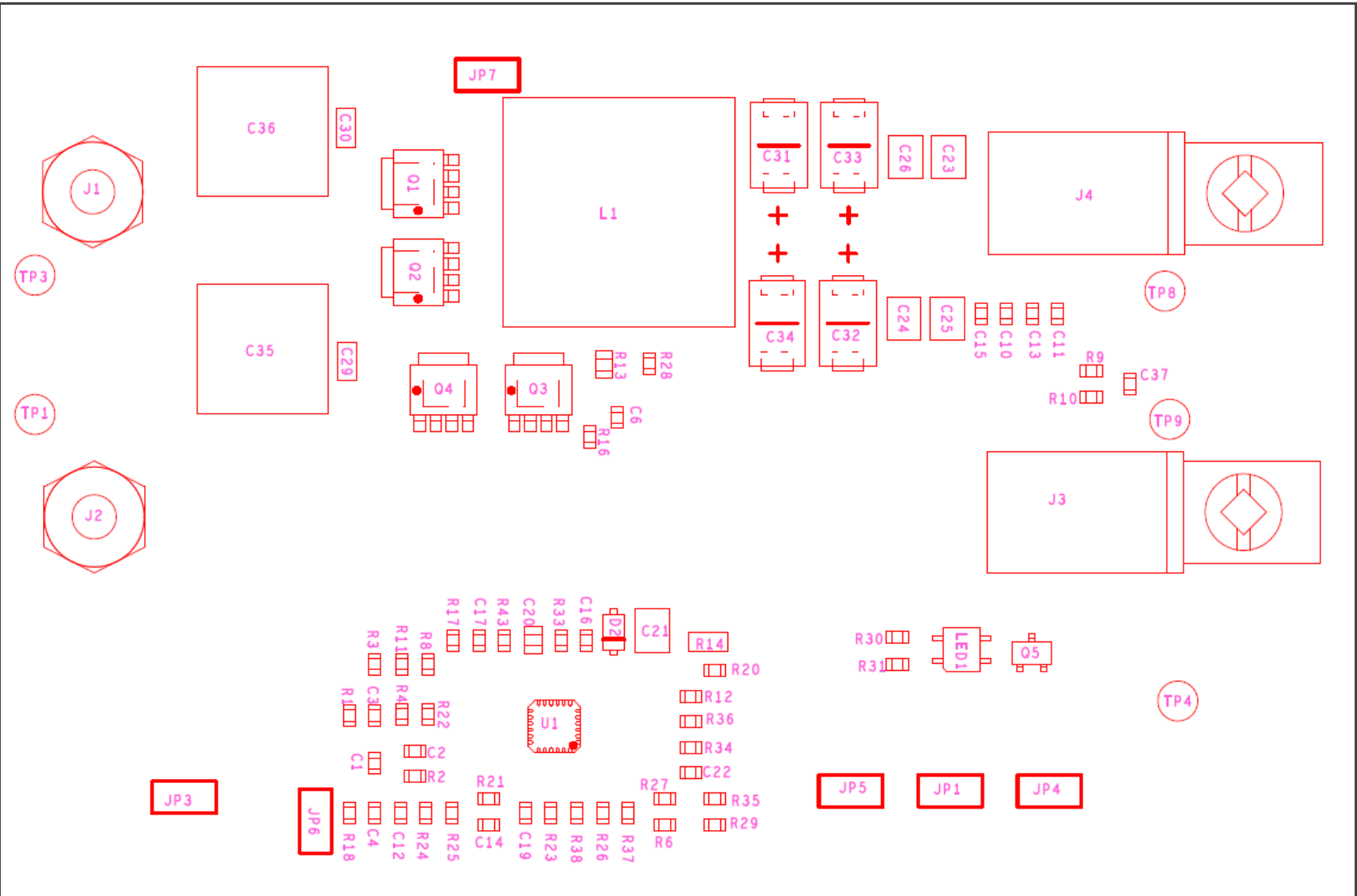

PCB Layout

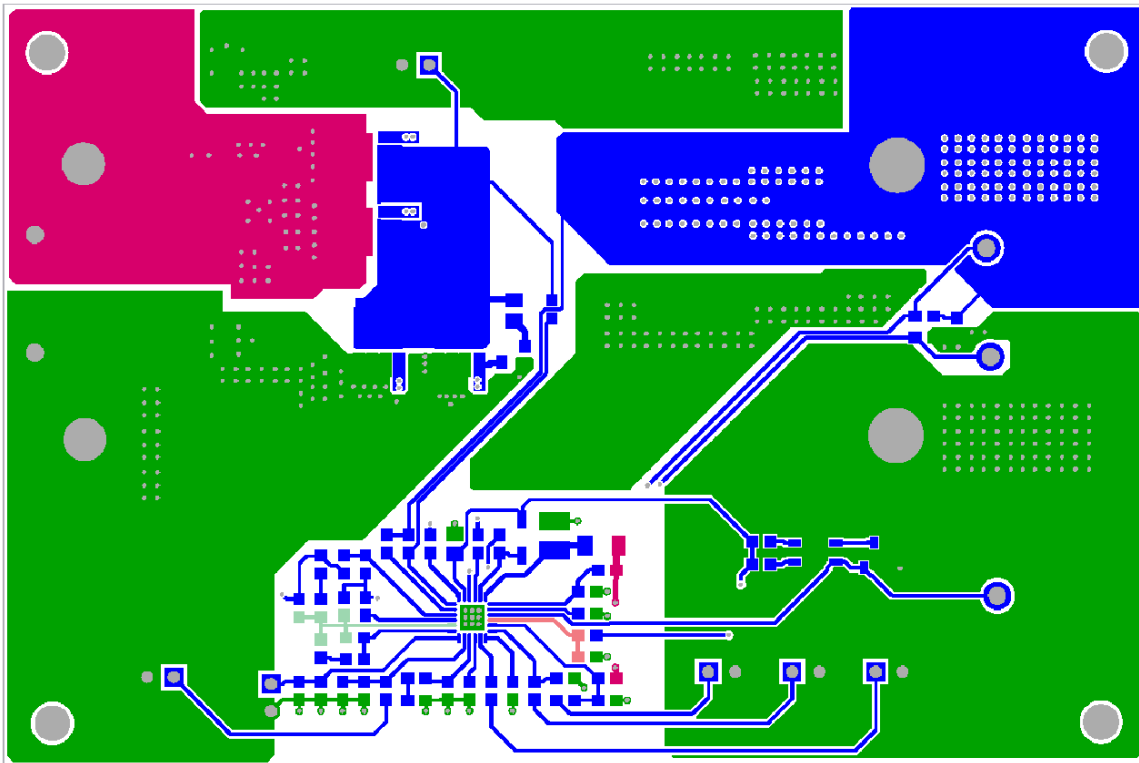

FIGURE 19. TOP LAYER

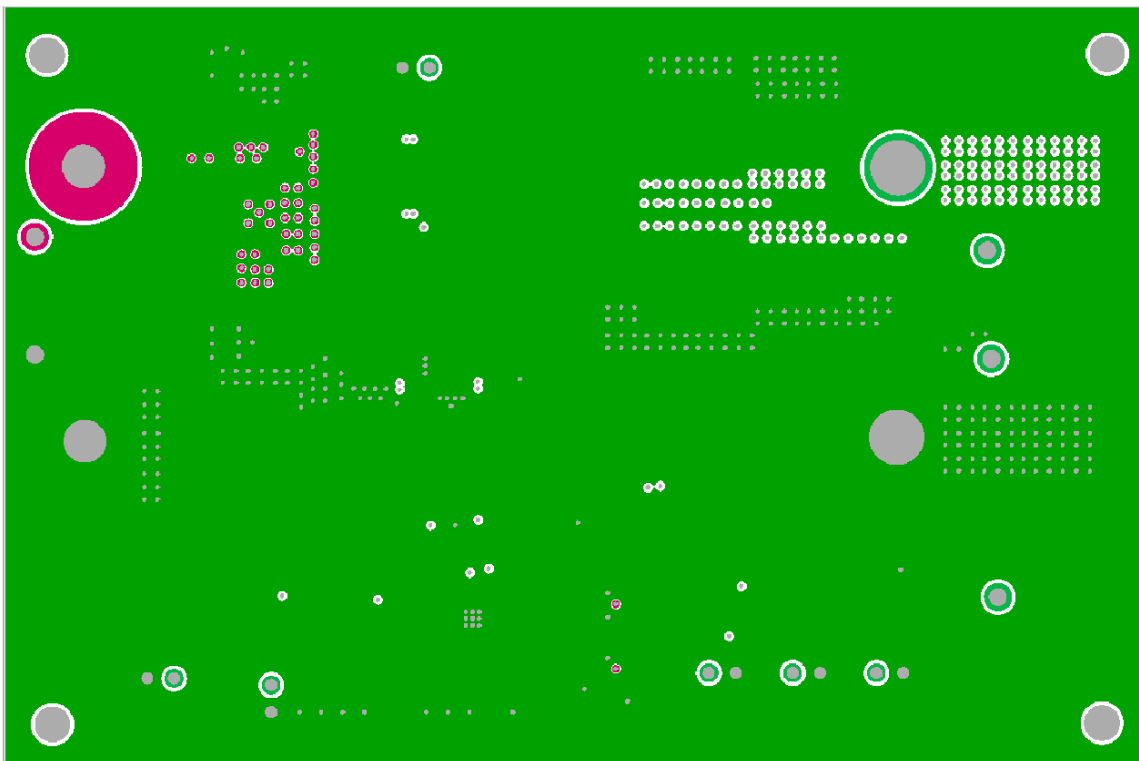

FIGURE 20. LAYER 2

PCB Layout (Continued)

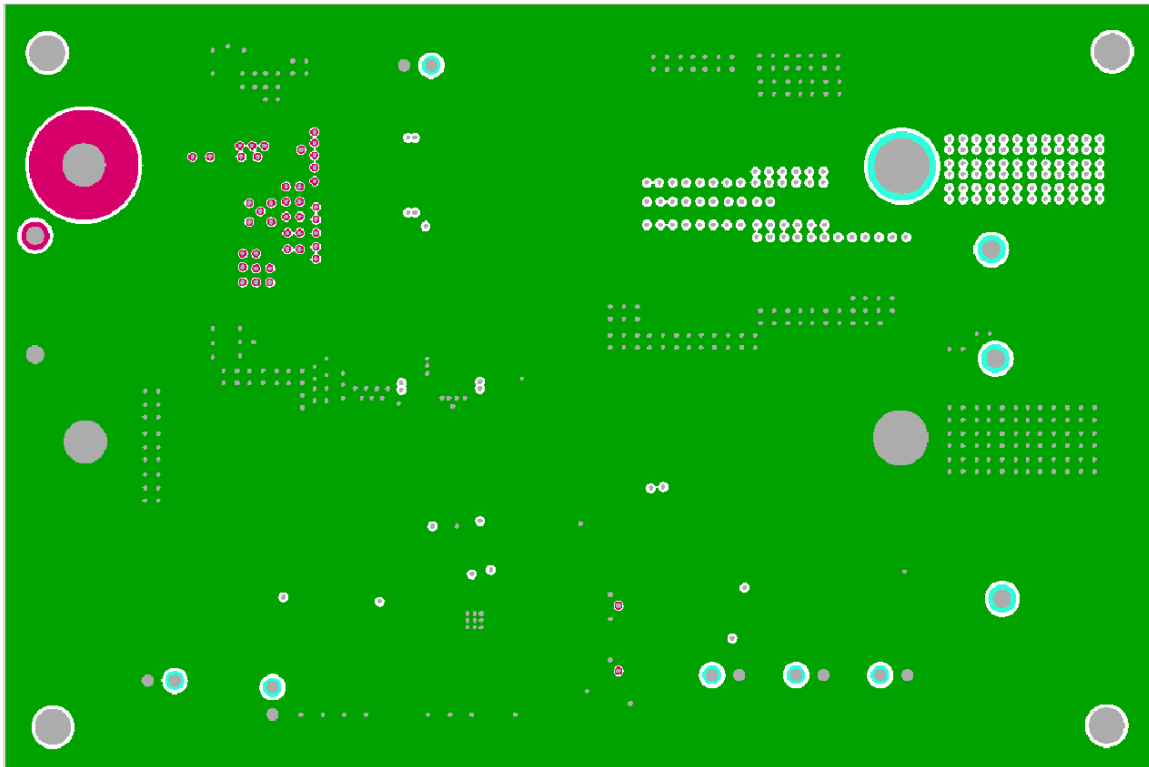

FIGURE 21. LAYER 3

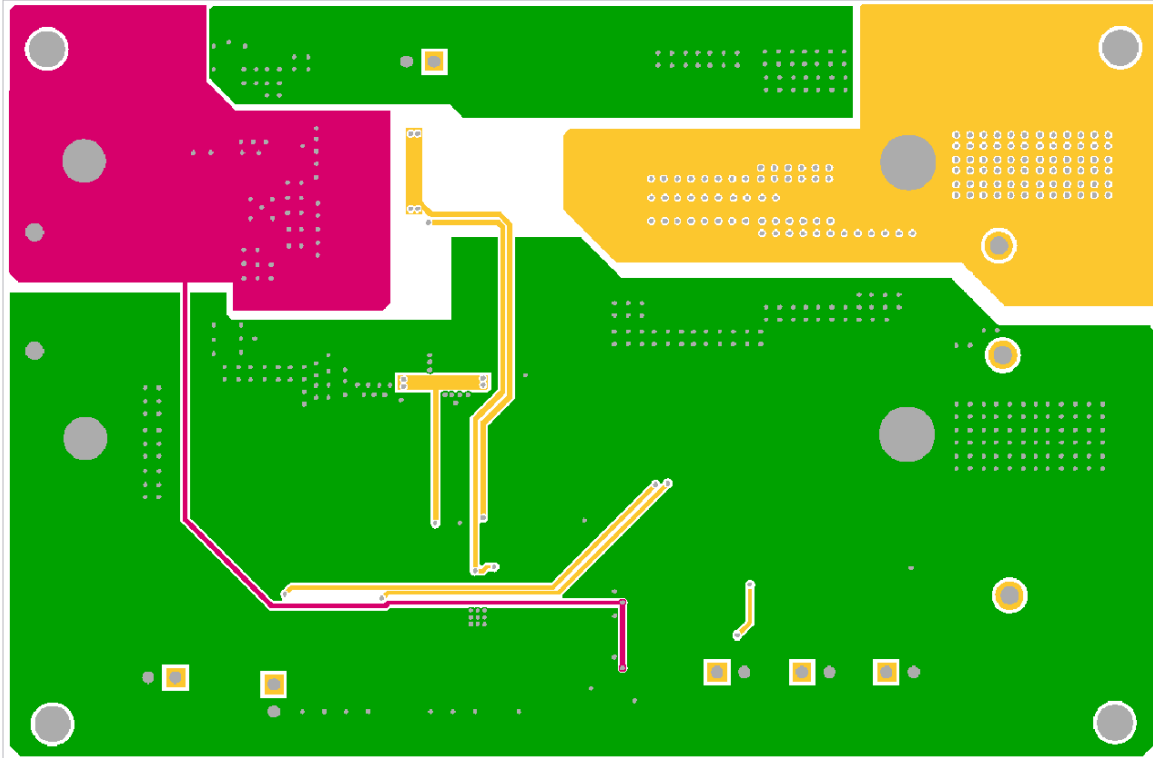

FIGURE 22. LAYER 4