

ISL81601EVAL1Z

User's Manual: Evaluation Board

Industrial Analog and Power

ISL81601EVAL1Z

Evaluation Board

UG162
Rev.1.00
Aug 6, 2018

1. Overview

The ISL81601EVAL1Z evaluation board (shown in [Figure 5 on page 8](#)) features the [ISL81601](#), a 60V high voltage synchronous buck-boost controller that offers external soft-start, independent enable functions and integrates UV/OV/OC/OT protection. A programmable switching frequency ranging from 100kHz to 600kHz helps to optimize inductor size while the strong gate driver delivers up to 20A for the buck-boost output.

1.1 Key Features

- Wide input range: 9V to 60V
- Bi-directional operation
- High light-load efficiency in pulse skipping DEM operation
- Programmable soft-start
- Optional DEM/PWM operation
- Optional CC/HICCUP OCP protection
- Supports prebias output with soft-start
- PGOOD indicator
- OVP, OTP, and UVP protection
- Back biased from output to improve efficiency

1.2 Specifications

The ISL81601EVAL1Z evaluation board is designed for high current applications. The current rating of the ISL81601EVAL1Z is limited by the FETs and inductor selected. The ISL81601EVAL1Z electrical ratings are shown in [Table 1](#).

Table 1. Electrical Rating

Parameter	Rating
Input Voltage	9V to 60V
Switching Frequency	200kHz
Output Voltage	12V
Output Current	10A
OCP Set Point	Minimum 11A at ambient room temperature

1.3 Ordering Information

Part Number	Description
ISL81601EVAL1Z	High Voltage Buck-Boost Controller Evaluation Board

1.4 Related Literature

For a full list of related documents, visit our website

- [ISL81601](#) product page

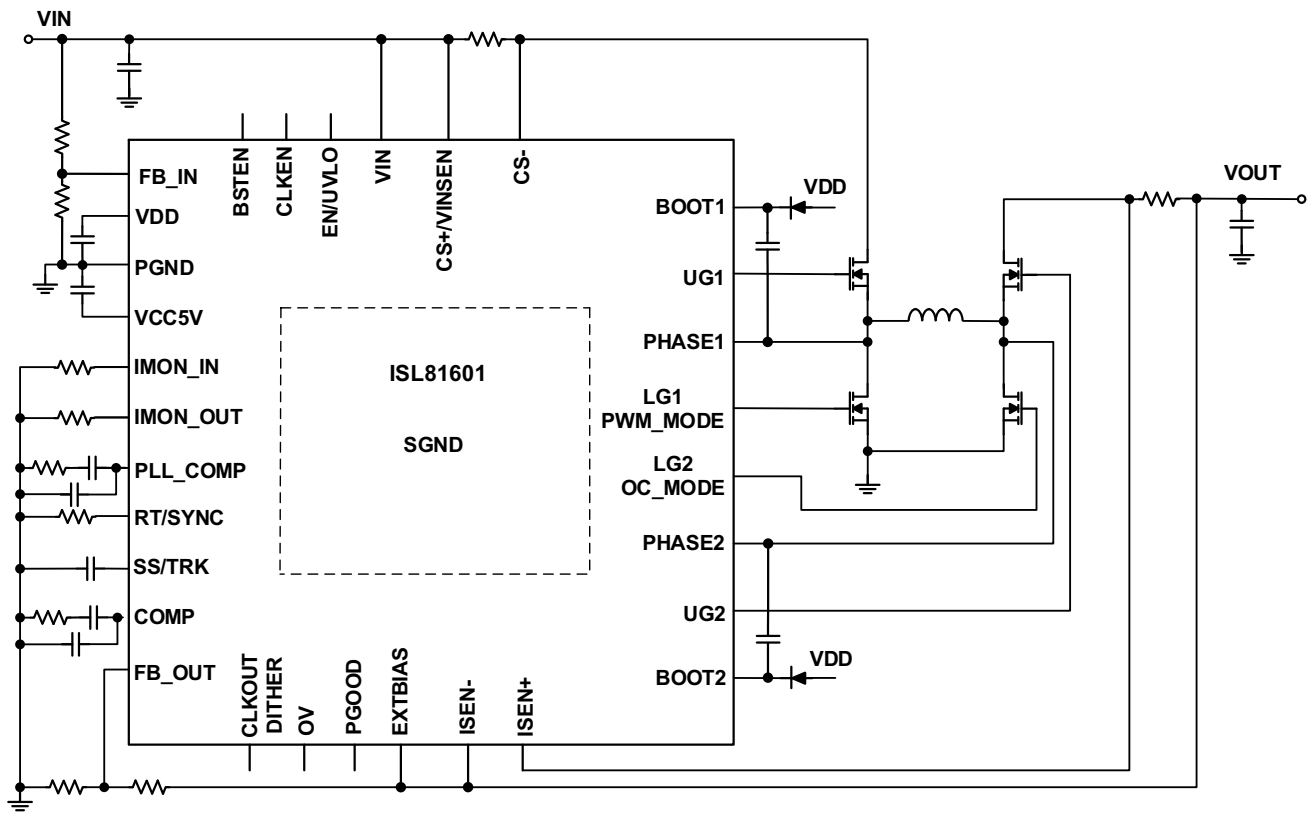

Figure 1. ISL81601EVAL1Z Block Diagram

2. Functional Description

The ISL81601EVAL1Z is the same test board used by Renesas application engineers and IC designers to evaluate the performance of the ISL81601 QFN IC. The board provides an easy and complete evaluation of all the IC and board functions.

As shown in [Figure 4 on page 6](#), 9V to 60V VIN is supplied to J1 (+) and J2 (-). The regulated 12V output on J4 (+) and J5 (-) can supply up to 10A to the load. Due to the high power efficiency, the evaluation board can run at 10A continuously without airflow at room temperature ambient conditions.

Test points TP1 through TP28 provide easy access to the IC pin and external signal injection terminals.

As shown in [Table 2 on page 5](#), connector J8 provides selection of either Forced PWM mode (shorting Pin 1 and Pin 2) or DEM mode (shorting Pin 2 and Pin 3). Connector J9 provides selection of either constant current limit (shorting Pin 1 and Pin 2) or HICCUP OCP (shorting Pin 2 and Pin 3). Connector J3 provides an option to disable the converter by shorting its Pin 1 and Pin 2.

2.1 Recommended Testing Equipment

The following materials are recommended for testing:

- 0V to 60V power supply with at least 30A source current capability
- Electronic loads capable of sinking current up to 20A
- Digital Multimeters (DMMs)
- 100MHz quad-trace oscilloscope

2.2 Operating Range

The input voltage range is from 9V to 60V for an output voltage of 12V. If the output voltage is set to a lower value, the minimum V_{IN} can be reset to a lower value by changing the ratio of R_2 and R_3 . The minimum EN threshold that V_{IN} can be set to is 4.5V.

The rated load current is 10A with the OCP point set at minimum 11A at ambient room temperature conditions. The operating temperature range of this board is -40°C to $+85^{\circ}\text{C}$. Note that airflow is needed for higher temperature ambient conditions.

2.3 Bi-Directional Operation

Refer to [Figure 2](#) for proper setup. Float the FBI pin (J7) and set the mode to CCM before powering on the board. The rated voltage of the super capacitor must be higher than 12V.

- (1) Adjust the input voltage higher than 9V. Switch on the input power source.
- (2) Switch off the input power source after the super capacitor is fully charged.

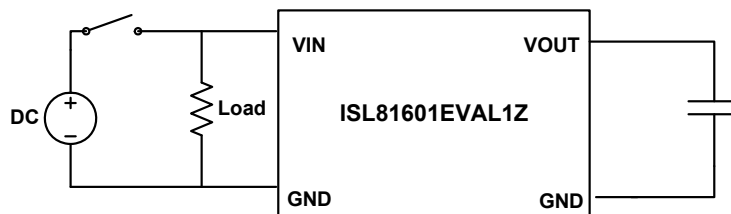

Figure 2. Proper Setup for Bi-Directional Operation

2.4 Quick Test Guide

- (1) Jumper J8 provides the option to select PWM or DEM. Jumper J9 provides the option to select constant current limit or HICCUP. Refer to [Table 2](#) for the operating options. Ensure that the circuit is correctly connected to the supply and electronic loads before applying any power. Refer to [Figure 4 on page 6](#) for proper setup.
- (2) Turn on the power supply.
- (3) Adjust input voltage V_{IN} within the specified range and observe the output voltage. The output voltage variation should be within 3%.
- (4) Adjust the load current within the specified range and observe the output voltage. The output voltage variation should be within 3%.
- (5) Use an oscilloscope to observe output voltage ripple and phase node ringing. For accurate measurement, refer to [Figure 3](#) for proper test setup.

Table 2. Operating Options

Jumper	Position	Function
3	EN-GND	Disable output
	EN Floating	Enable output
6	I_{IN} Floating	Enable input current limit
	I_{IN} -VCC5	Disable input current limit
7	FBI-GND	Disable V_{IN} limit
	FBI Floating	Enable V_{IN} limit
8	Pin 1-2	PWM
	Pin 2-3	DEM
9	Pin 1-2	Constant current limit
	Pin 2-3	HICCUP

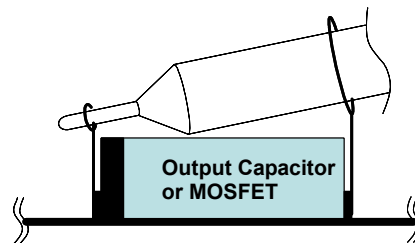

Figure 3. Proper Probe Setup to Measure Output Ripple and Phase Node Ringing

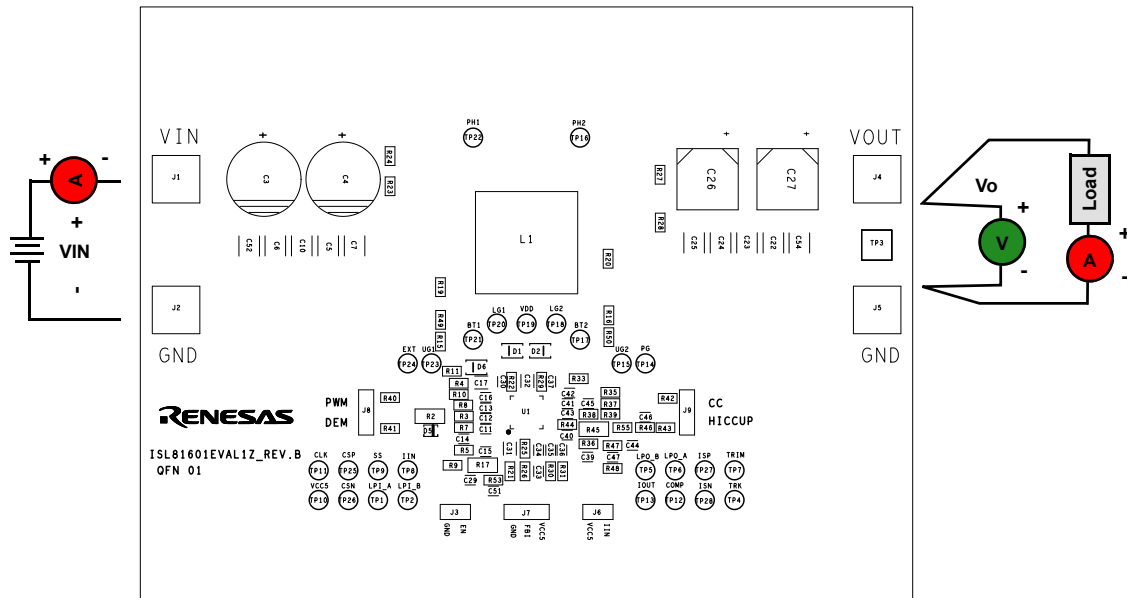

Figure 4. Proper Test Setup

3. PCB Layout Guidelines

Careful attention to Printed Circuit Board (PCB) layout requirements is necessary for successful implementation of an ISL81601 based DC/DC converter. The ISL81601 switches at a very high frequency; therefore the switching times are very short. At these switching frequencies, even the shortest trace has significant impedance and the peak gate drive current rises significantly in an extremely short time. The transition speed of the current from one device to another causes voltage spikes across the interconnecting impedances and parasitic circuit elements. These voltage spikes can degrade efficiency, generate EMI, and increase device voltage stress and ringing. Careful component selection and proper PC board layout minimizes the magnitude of these voltage spikes.

Three sets of components are critical when using the ISL81601 DC/DC converter:

- Controller
- Switching power components
- Small signal components

The switching power components are the most critical to the layout because they switch a large amount of energy, which tends to generate a large amount of noise. The critical small signal components are those connected to sensitive nodes or those supplying critical bias currents. A multilayer PCB is recommended.

Complete the following steps to optimize the PCB layout.

- (1) Place the input capacitors, buck FETs, inductor, boost FETs, and output capacitor first. Isolate these power components on dedicated areas of the board with their ground terminals adjacent to one another. Place the input and output high frequency decoupling ceramic capacitors very close to the MOSFETs.
- (2) If signal components and the IC are placed separately from the power train, Renesas recommends us full ground planes in the internal layers with shared SGND and PGND to simplify the layout design. Otherwise, use separate ground planes for the power ground and the small signal ground. Connect the SGND and PGND together close to the IC. DO NOT connect them together anywhere else.
- (3) The loop formed by the input capacitor, the buck top FET, and the buck bottom FET must be as small as possible. The loop formed by the output capacitor, the boost top FET, and the boost bottom FET must also be as small as possible.
- (4) Ensure the current paths from the input capacitor to the buck FETs, the power inductor, the boost FETs, and the output capacitor are as short as possible with maximum allowable trace widths.
- (5) Place the PWM controller IC close to the lower FETs. The low-side FETs gate drive connections should be short and wide. The IC should be placed over a quiet ground area. Avoid switching ground loop currents in this area.
- (6) Place the VDD bypass capacitor very close to the VDD pin of the IC and connect its ground end to the PGND pin. Connect the PGND pin to the ground plane by a via. Do not connect the PGND pin directly to the SGND EPAD.
- (7) Place the gate drive components (BOOT diodes and BOOT capacitors) together near the controller IC.
- (8) Place the output capacitors as close to the load as possible. Use short, wide copper regions to connect output capacitors to load to avoid inductance and resistances.
- (9) Use copper filled polygons or wide, short traces to connect the junction of the buck or boost upper FET, buck or boost lower FET, and output inductor. Keep the buck and boost PHASE nodes connection to the IC short. DO NOT unnecessarily oversize the copper islands for the PHASE nodes. Because the phase nodes are subjected to very high dv/dt voltages, the stray capacitor formed between these islands and the surrounding circuitry tends to couple switching noise.
- (10) Route all high speed switching nodes away from the control circuitry.
- (11) Create a separate small analog ground plane near the IC. Connect the SGND pin to this plane. All small signal grounding paths including feedback resistors, current monitoring resistors and capacitors, soft-starting capacitors, loop compensation capacitors and resistors, and EN pull-down resistors should be connected to this SGND plane.
- (12) Use a pair of traces with minimum loop for the input or output current sensing connection.
- (13) Ensure the feedback connection to the output capacitor is short and direct.

3.1 ISL81601VAL1Z Evaluation Board

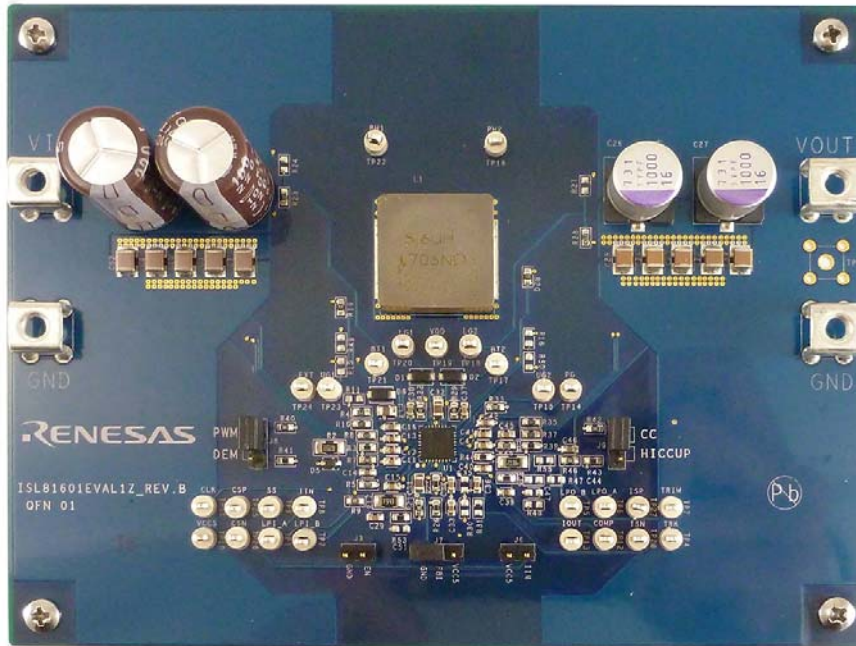

Figure 5. ISL81601VAL1Z Evaluation Board, Top View

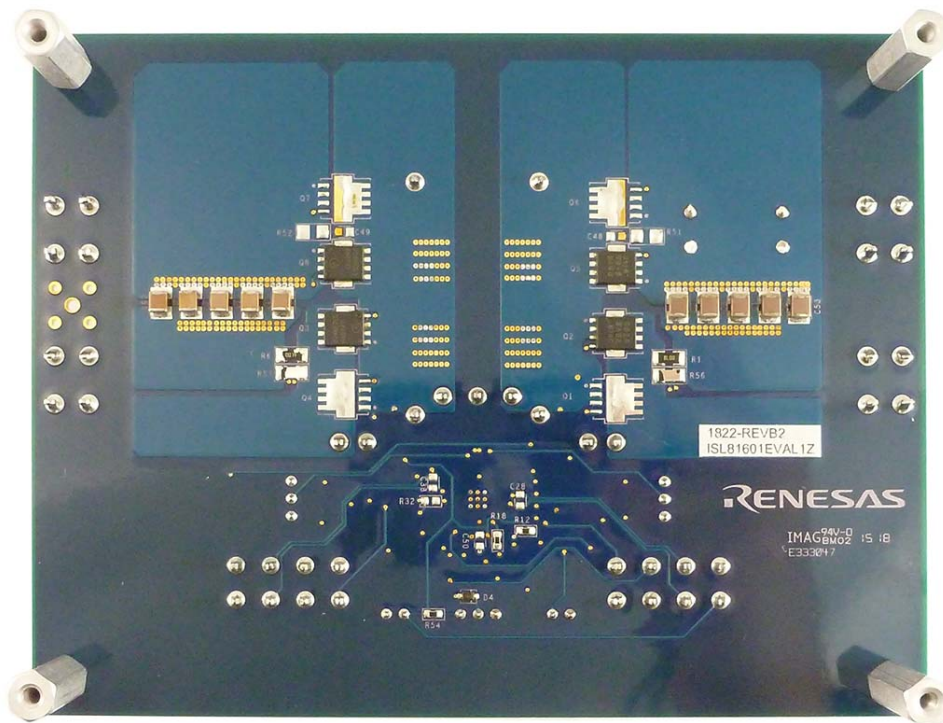

Figure 6. ISL81601VAL1Z Evaluation Board, Bottom View

3.2 ISL81601VAL1Z Circuit Schematic

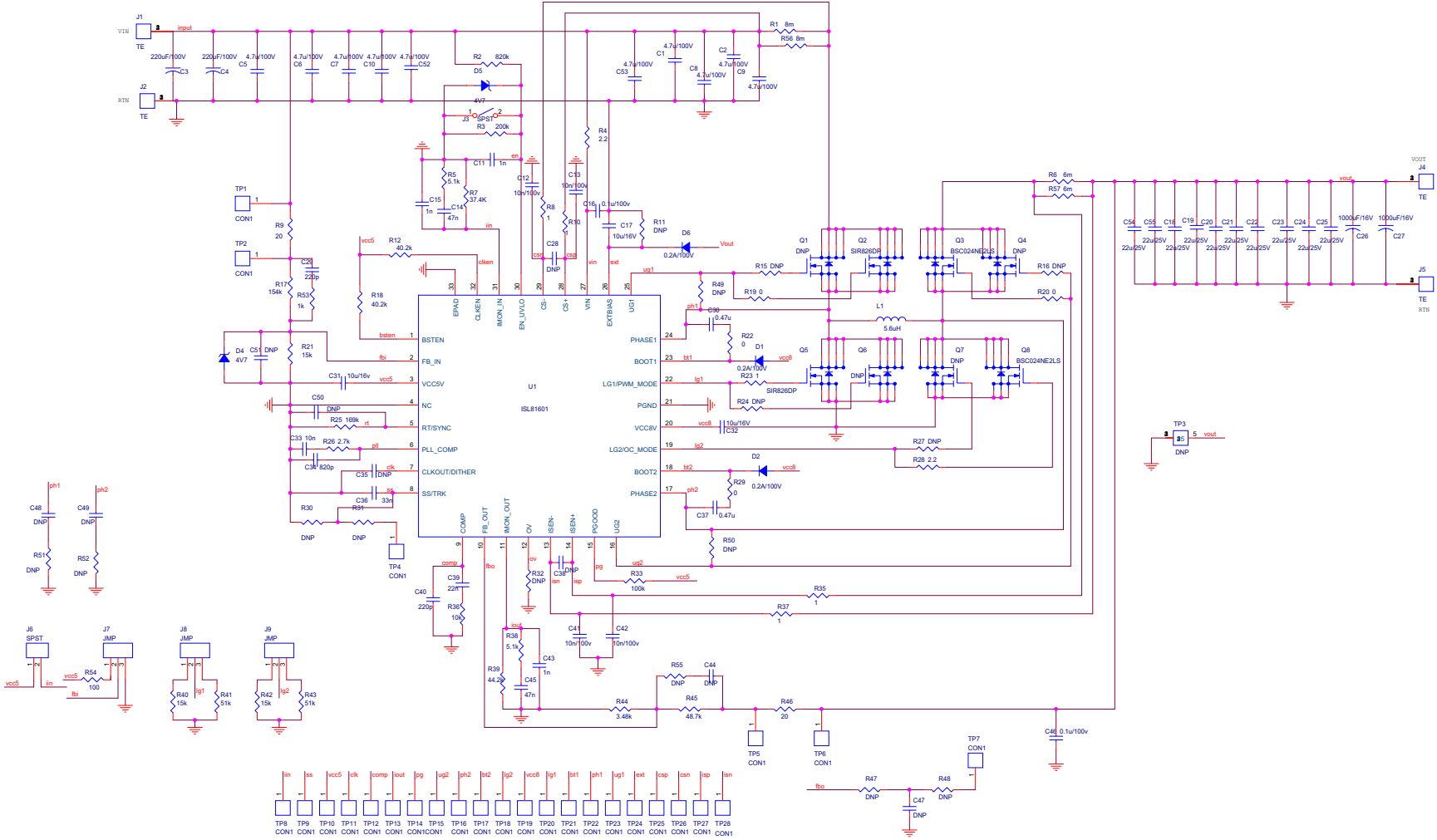

Figure 7. Schematic

3.3 Bill of Materials

Qty	Reference Designator	Description	Manufacturer	Manufacturer Part
1		PWB-PCB, ISL81601EVAL1Z, REVA, ROHS	Imagineering INC	ISL81601EVAL1ZREVAPCB
1	C33	CAP-AEC-Q200, SMD, 0603, 0.01 μ F, 50V, 10%, X7R, ROHS	TDK	CGA3E2X7R1H103K080AE
10	C1, C2, C5, C6, C7, C8, C9, C10, C52, C53	CAP-AEC-Q200, SMD, 1210, 4.7 μ F, 100V, 10%, X7S, ROHS	TDK	CGA6M3X7S2A475K200AE
1	C39	CAP-AEC-Q200, SMD, 0603, 0.022 μ F, 25V, 10%, X7R, ROHS	TDK	CGJ3E2X7R1E223K080AA
1	C36	CAP-AEC-Q200, SMD, 0603, 0.033 μ F, 25V, 10%, X7R, ROHS	TDK	CGJ3E2X7R1E333K080AA
2	C14, C45	CAP-AEC-Q200, SMD, 0603, 0.047 μ F, 25V, 10%, X7R, ROHS	TDK	CGJ3E2X7R1E473K080AA
2	C16, C46	CAP-BOARDFLEX, SMD, 0603, 0.1 μ F, 100V, 10%, X7R, ROHS	Murata	GRJ188R72A104KE11D
3	C17, C31, C32	CAP, SMD, 0805, 10 μ F, 16V, 10%, X7S, ROHS	Murata	GRM21BC71C106KE11L
10	C18, C19, C20, C21, C22, C23, C24, C25, C54, C55	CAP, SMD, 1210, 22 μ F, 25V, 10%, X7R, ROHS	Murata	GRM32ER71E226KE15L
3	C11, C15, C43	CAP, SMD, 0603, 1000pF, 50V, 10%, X7R, ROHS	AVX	06035C102KAT2A
4	C12, C13, C41, C42	CAP, SMD, 0603, 0.01 μ F, 100V, 10%, X7R, ROHS	Kemet	C0603C103J1RACTU
1	C29	CAP, SMD, 0603, 220pF, 100V, 5%, X7R, ROHS	Panasonic	ECJ-1VB2A221K
1	C40	CAP, SMD, 0603, 220pF, 50V, 10%, X7R, ROHS	Murata	GRM188R71H221KA01D
2	C30, C37	CAP, SMD, 0603, 0.47 μ F, 25V, 10%, X7R, ROHS	Murata	GRM188R71E474KA12D
1	C34	CAP, SMD, 0603, 820pF, 50V, 10%, X7R, ROHS	Kemet	C0603C821K5RACTU
0	C28, C35, C38, C44, C47, C48, C49, C50, C51	CAP, SMD, 0603, DNP-PLACE HOLDER, ROHS		
2	C26, C27	CAP-OSCON, SMD, 10mm, 1000 μ F, 16V, 20%, 12m Ω , ROHS	Sanyo	16SVPF1000M
4	C3, C4	CAP, RADIAL, 12.5x26.5, 220 μ F, 100V, 20%, ALUM.ELEC., 5mm, ROHS	United Chemi-Con	EKZN101ELL221MK25S
1	L1	COIL-PWR INDUCTOR, SMD, 17.15mm, 5.6 μ H, 20%, 28A, 4.23m Ω , ROHS	Vishay	IHLP6767GZER5R6M11
27	TP1, TP2, TP4-TP28	CONN-COMPACT TEST PT, VERTICAL, WHT, ROHS	Keystone	5007
2	J3, J6	CONN-HEADER, 1x2, BRKAWY 1x36, 2.54mm, ROHS	BERG/FCI	68000-236HLF
3	J7, J8, J9	CONN-HEADER, 1x3, BREAKAWY 1x36, 2.54mm, ROHS	BERG/FCI	68000-236HLF
3	D1, D2, D6	DIODE-RECTIFIER, SMD, 2P, S0D-123FL, 100V, 1A, ROHS	On Semiconductor	MBR1H100SFT3G

Qty	Reference Designator	Description	Manufacturer	Manufacturer Part
2	D4, D5	DIODE-ZENER, SMD, SOD-323, 4.7V, 6%, 300mW, ROHS	Diodes, INC.	MM3Z4V7T1G
1	U1	IC-60V 4-SWITCH PWM CONTROLLER, 32P, QFN, 5x5, ROHS	Renesas Electronics America	ISL81601FRZ
2	Q3, Q8	TRANSIST-MOS, N-CHANNEL, SMD, 8P, PG-TDSON, 25V, 25A, ROHS	Infineon Technology	BSC024NE2LSATMA1
2	Q2, Q5	TRANSISTOR-MOS, N-CHANNEL, SMD, 8P, PPK SO-8, 80V, 60A, ROHS	Vishay/Siliconix	SIR826DP-T1-GE3
4	R8, R10, R23, R35, R37	RES, SMD, 0603, 1Ω, 1/10W, 1%, TF, ROHS	Panasonic	ERJ-3RQF1R0V
2	R9, R46	RES, SMD, 0603, 20Ω, 1/10W, 1%, TF, ROHS	Panasonic	ERJ-3EKF20R0V
2	R4, R28	RES, SMD, 0603, 2.2Ω, 1/10W, 1%, TF, ROHS	Panasonic	ERJ-3RQF2R2V
4	R19, R20, R22, R29	RES, SMD, 0603, 0Ω, 1/10W, TF, ROHS	Venkel	CR0603-10W-000T
1	R54	RES, SMD, 0603, 100Ω, 1/10W, 1%, TF, ROHS	Venkel	CR0603-10W-1000FT
1	R53	RES, SMD, 0603, 1k, 1/10W, 1%, TF, ROHS	Panasonic	ERJ-3EKF1001V
1	R36	RES, SMD, 0603, 10k, 1/10W, 1%, TF, ROHS	Venkel	CR0603-10W-1002FT
1	R33	RES, SMD, 0603, 100k, 1/10W, 1%, TF, ROHS	Venkel	CR0603-10W-1003FT
3	R21, R40, R42	RES, SMD, 0603, 15k, 1/10W, 1%, TF, ROHS	Panasonic	ERJ-3EKF1502V
1	R25	RES, SMD, 0603, 169k, 1/10W, 1%, TF, ROHS	Venkel	CR0603-10W-1693FT
1	R53	RES, SMD, 0603, 200k, 1/10W, 1%, TF, ROHS	Venkel	CR0603-10W-2003FT
1	R26	RES, SMD, 0603, 2.7k, 1/10W, 1%, TF, ROHS	Venkel	CR0603-10W-2701FT
1	R44	RES, SMD, 0603, 3.48k, 1/10W, 1%, TF, ROHS	Panasonic	ERJ-3EKF3481V
1	R7	RES, SMD, 0603, 37.4k, 1/10W, 1%, TF, ROHS	Yageo	RC0603FR-0737K4L
2	R12, R18	RES, SMD, 0603, 40.2k, 1/10W, 1%, TF, ROHS	Yageo	RC0603FR-0740K2L
1	R39	RES, SMD, 0603, 44.2k, 1/10W, 1%, TF, ROHS	Venkel	CR0603-10W-4422FT
2	R5, R38	RES, SMD, 0603, 5.1k, 1/10W, 1%, TF, ROHS	Venkel	CR0603-10W-5101FT
2	R41, R43	RES, SMD, 0603, 51k, 1/10W, 1%, TF, ROHS	Yageo	RC0603FR-0751KL
0	R14, R15, R16, R24, R27, R30, R31, R32, R47, R48, R49, R50, R55	RES, SMD, 0603, DNP-PLACE HOLDER, ROHS		
1	R17	RES, SMD, 1206, 154k, 1/4W, 1%, TF, ROHS	Yageo	RC1206FR-07154KL

Qty	Reference Designator	Description	Manufacturer	Manufacturer Part
1	R45	RES, SMD, 1206, 48.7k, 1/4W, 1%, TF, ROHS	Yageo	RC1206FR-0748K7L
1	R2	RES, SMD, 1206, 820k, 1/4W, 1%, TF, ROHS	Yageo	AC1206FR-07820KL
0	R51, R52	RES, SMD, 1206, DNP, DNP, DNP, TF, ROHS		
2	R6, R57	RES, SMD, 1206, 0.006Ω, 1W, 1%, TF, ROHS	Rohm	PMR18EZPFU6L00
2	R1, R56	RES, SMD, 1206, 0.008Ω, 1W, 1%, TF, ROHS	Rohm	PMR18EZPFU8L00
4	Four corners	SCREW, 4-40X1/4in, PHILLIPS, PANHEAD, STAINLESS, ROHS	Building Fasteners	PMSSS 440 0025 PH
4	Four corners	STANDOFF, 4-40X3/4in, F/F, HEX, ALUMINUM, 0.25 OD, ROHS	Keystone	2204
4	J1, J2, J4, J5	HDWARE, TERMINAL, M4 METRIC SCREW, TH, 4P, SNAP-FIT, ROHS	Keystone	7795
1	Place assy in bag	BAG, STATIC, 6X8, ZIPLOC, ROHS	Uline	S-2262
0	Q1, Q4, Q6, Q7	DO NOT POPULATE OR PURCHASE		
0	TP3	DO NOT POPULATE OR PURCHASE		
1	AFFIX TO BACK OF PCB	LABEL-DATE CODE_LINE 1: YRWK/REV#, LINE 2: BOM NAME	Renesas Electronics America	LABEL-DATE CODE

3.4 Board Layout

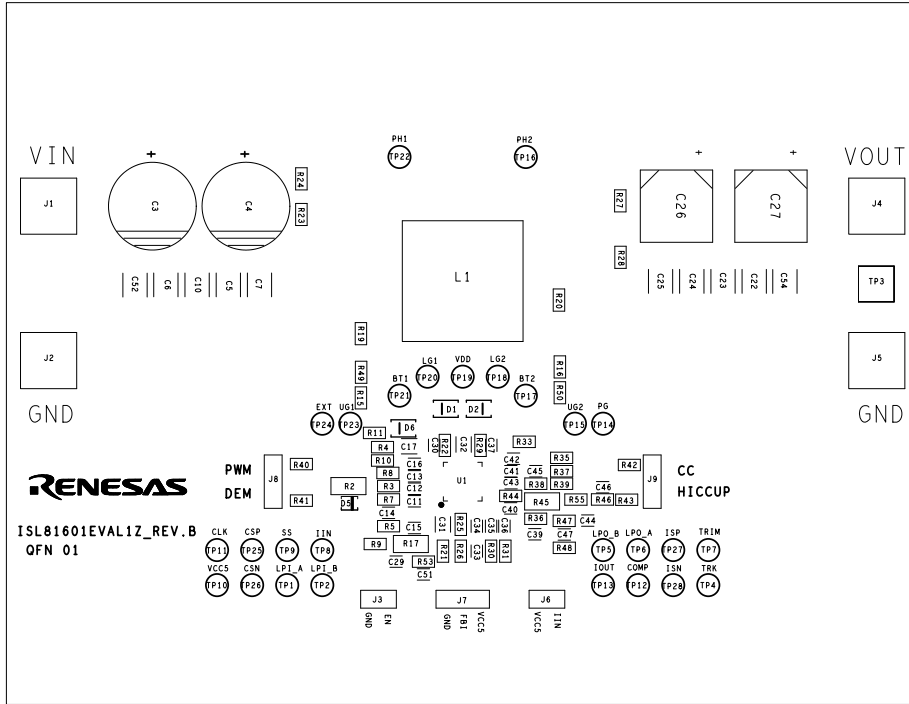

Figure 8. Silkscreen Top

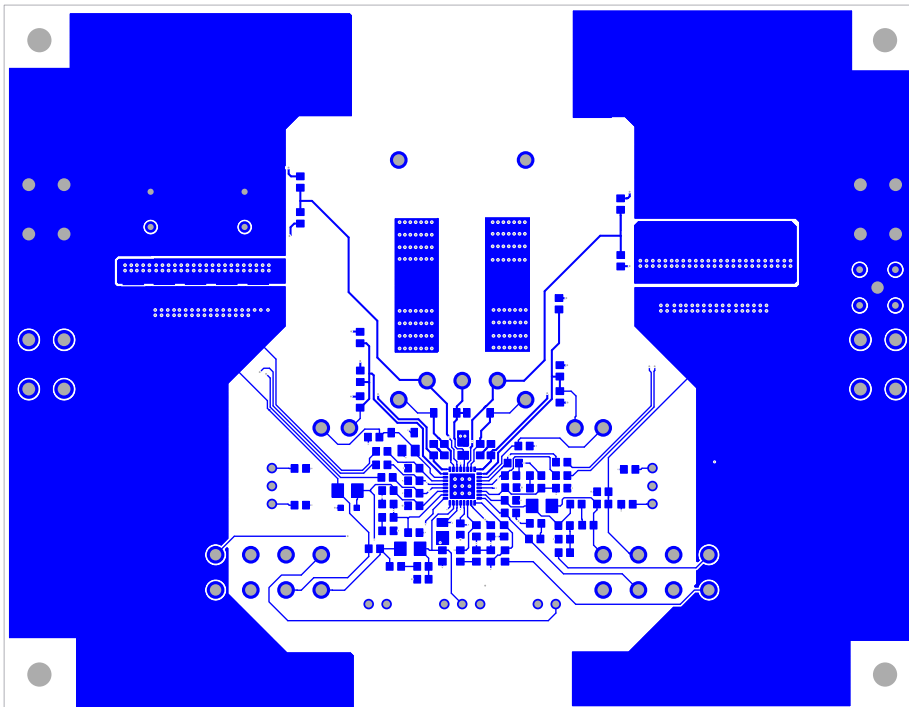

Figure 9. Top Layer

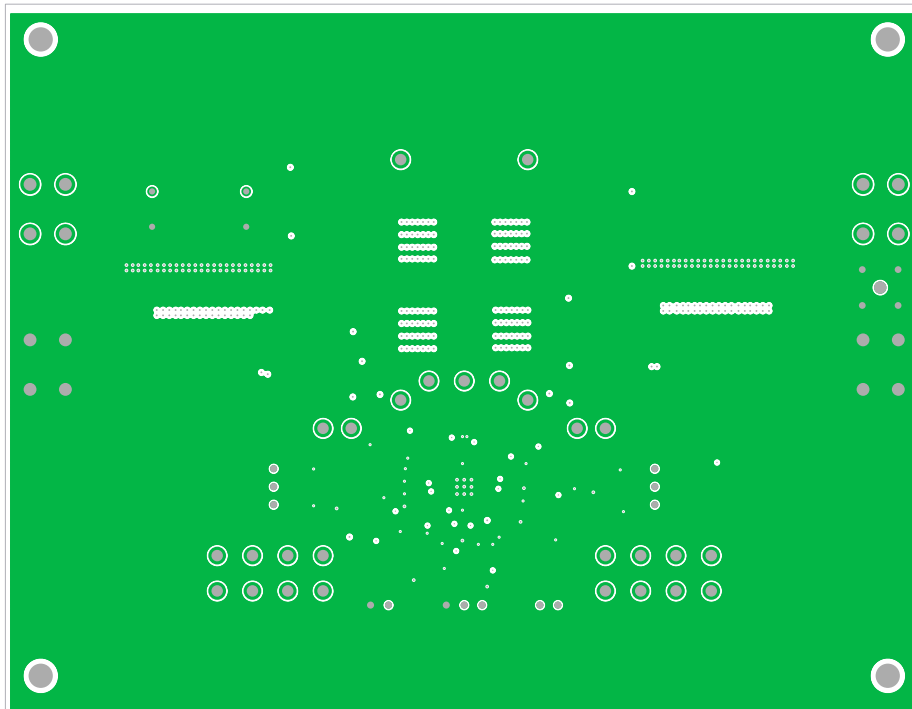

Figure 10. Second Layer (Solid Ground)

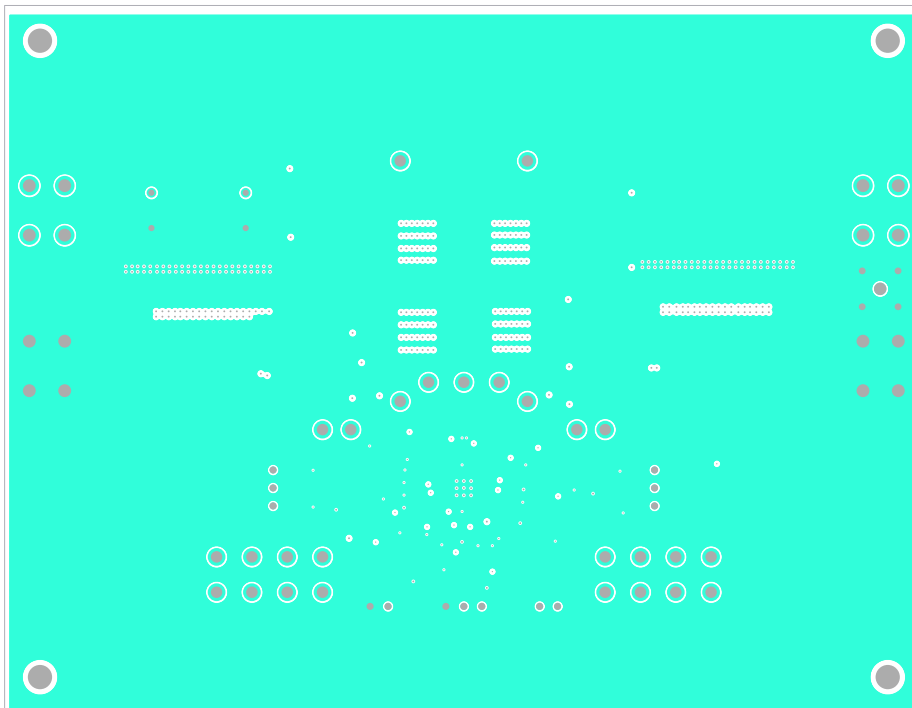

Figure 11. Third Layer

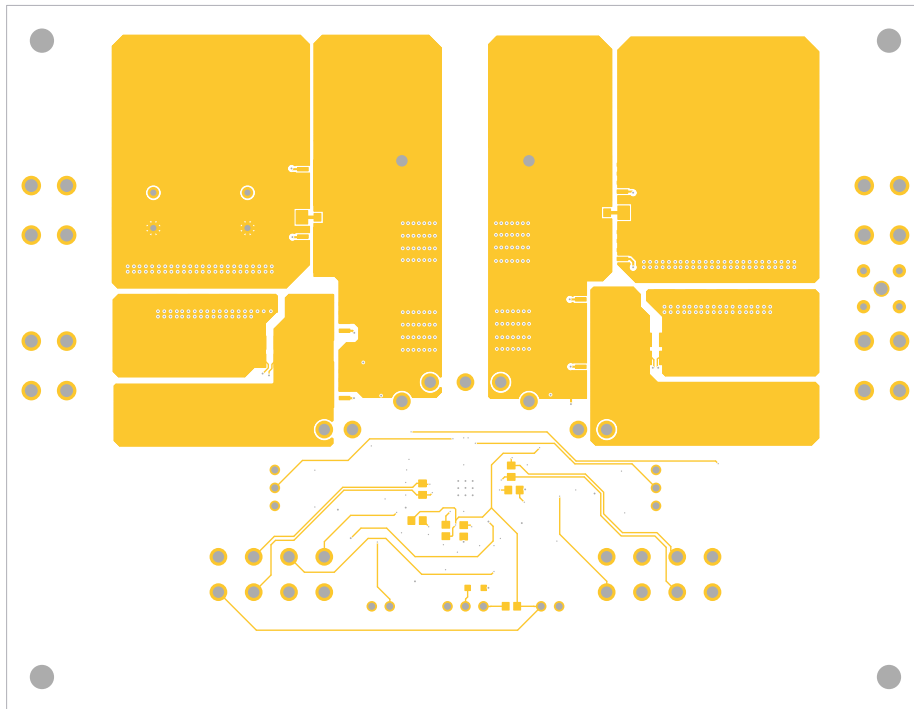

Figure 12. Bottom Layer

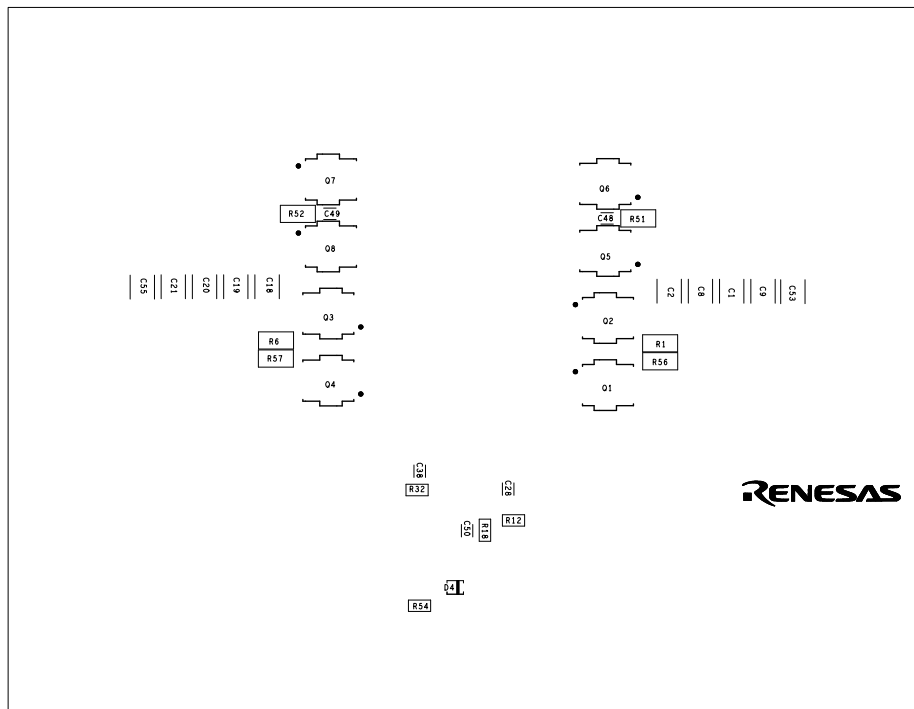

Figure 13. Silkscreen Bottom

4. Typical Performance Curves

$V_{IN} = 12V$, unless otherwise noted.

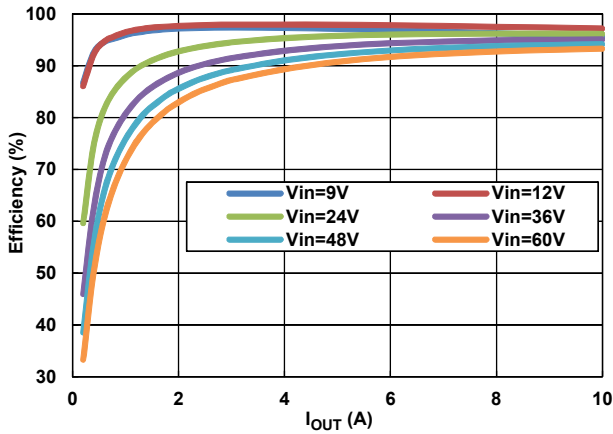

Figure 14. Efficiency, CCM

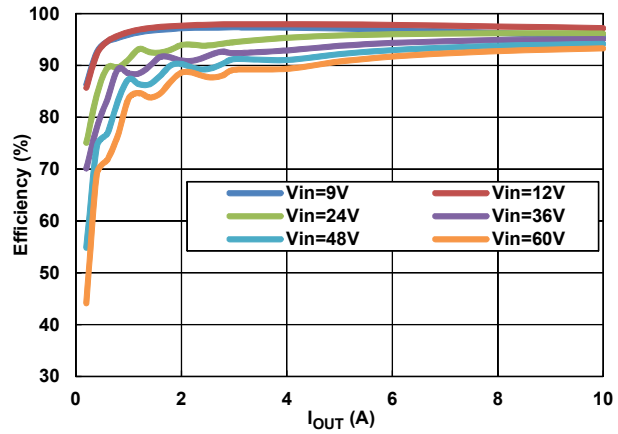

Figure 15. Efficiency, DEM

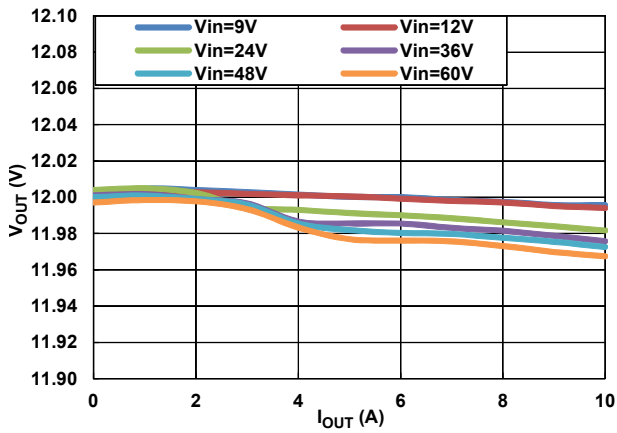

Figure 16. Load Regulation, CCM

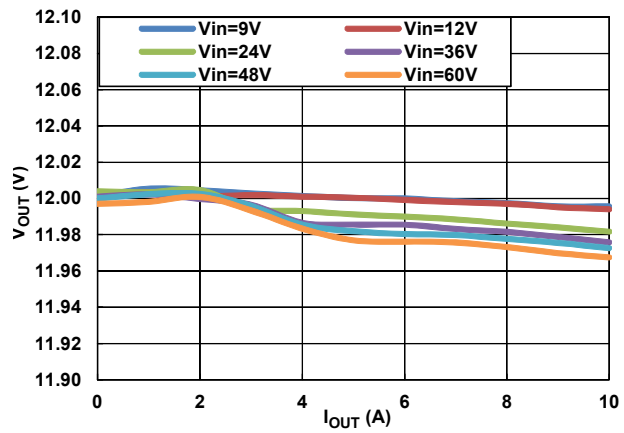

Figure 17. Load Regulation, DEM

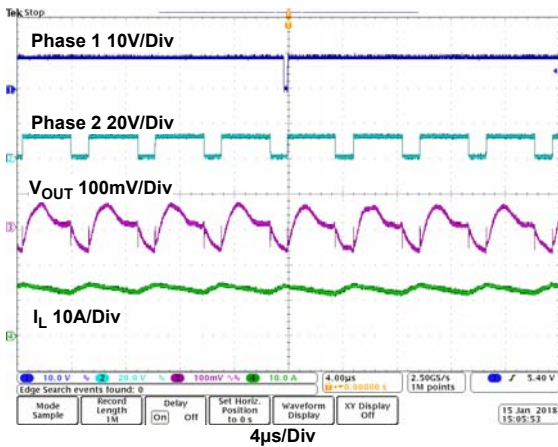

Figure 18. Phase 1, Phase 2, V_{OUT} and Inductor Current, $V_{IN} = 9V$, $I_{OUT} = 10A$

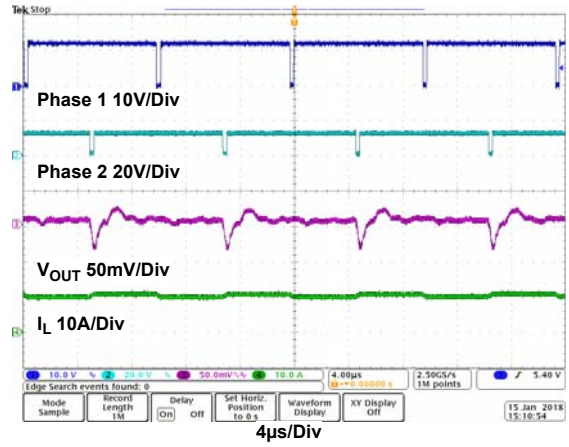

Figure 19. Phase 1, Phase 2, V_{OUT} and Inductor Current, $V_{IN} = 12V$, $I_{OUT} = 10A$

$V_{IN} = 12V$, unless otherwise noted. (Continued)

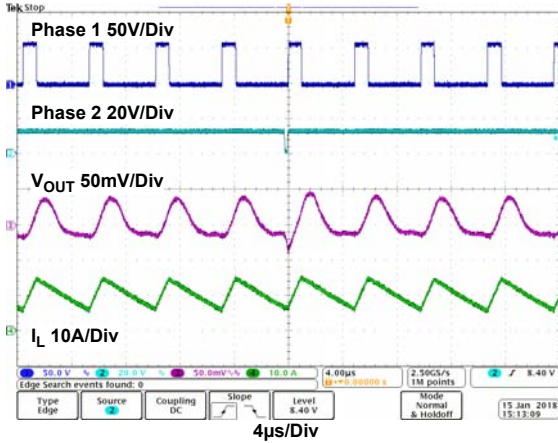

Figure 20. Phase 1, Phase 2, V_{OUT} and Inductor Current, $V_{IN} = 60V$, $I_{OUT} = 10A$

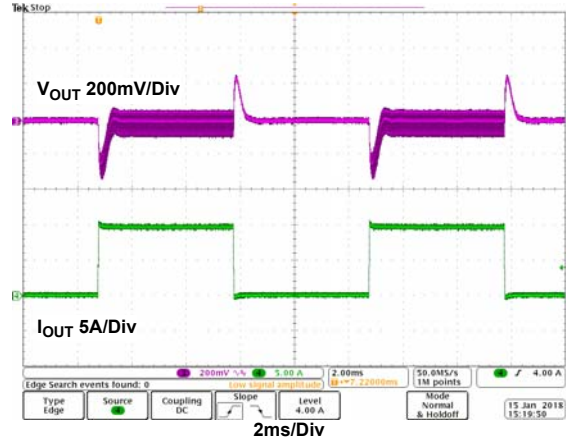

Figure 21. Load Transient, $V_{IN} = 9V$, $I_{OUT} = 0A$ to $10A$, $2.5A/\mu s$, CCM

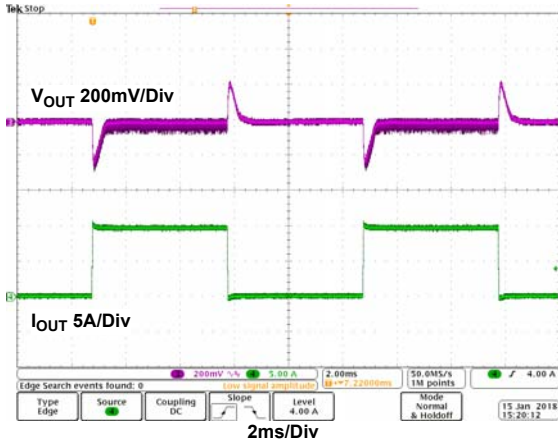

Figure 22. Load Transient, $V_{IN} = 12V$, $I_{OUT} = 0A$ to $10A$, $2.5A/\mu s$, CCM

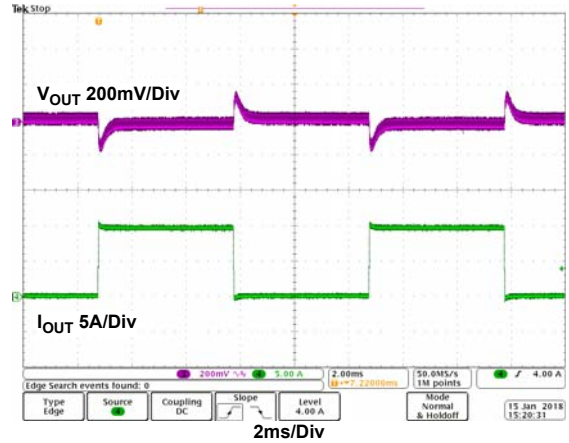

Figure 23. Load Transient, $V_{IN} = 60V$, $I_{OUT} = 0A$ to $10A$, $2.5A/\mu s$, CCM

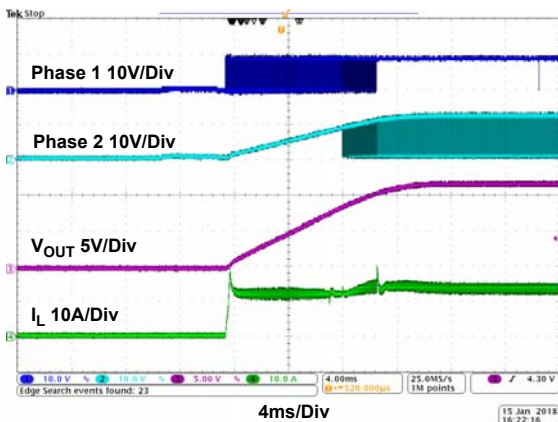

Figure 24. Start-Up Waveform, $V_{IN} = 9V$, $I_{OUT} = 10A$, CCM

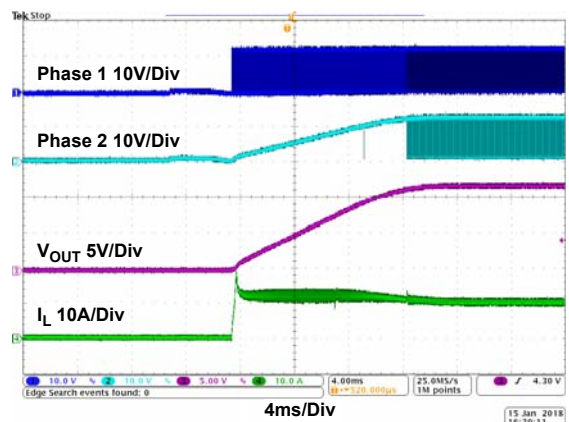

Figure 25. Start-Up Waveform, $V_{IN} = 12V$, $I_{OUT} = 10A$, CCM

$V_{IN} = 12V$, unless otherwise noted. (Continued)

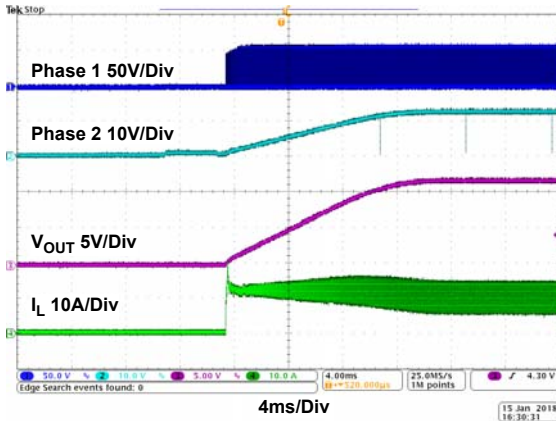

Figure 26. Start-Up Waveform, $V_{IN} = 60V$, $I_{OUT} = 10A$, CCM

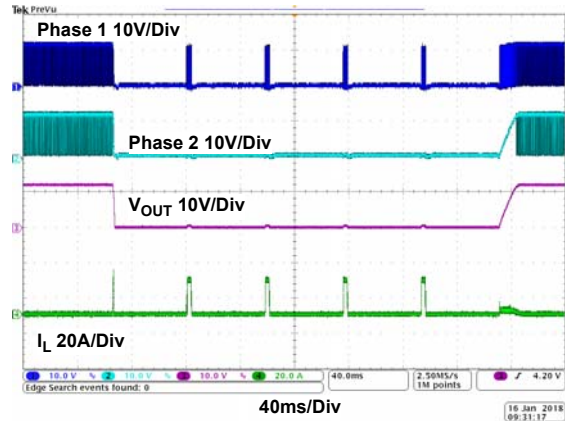

Figure 27. Short-Circuit Waveform

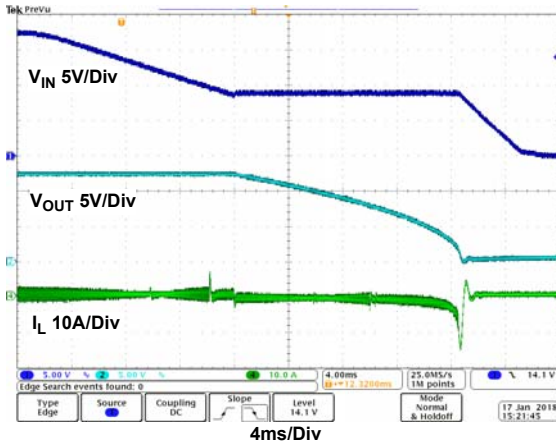

Figure 28. Bi-Directional Operation, $V_{IN} = 18V$, $V_{in_limit} = 9V$, $I_{IN} = 1A$

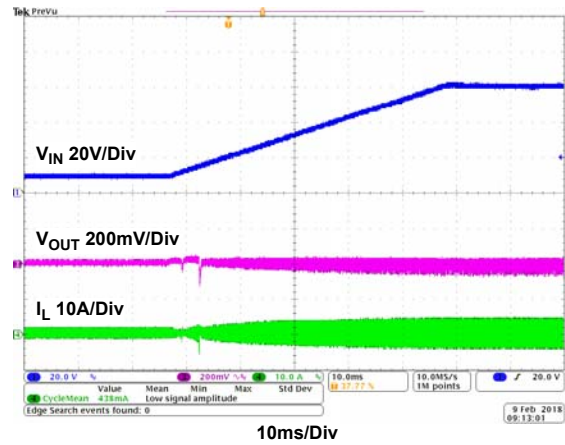

Figure 29. Line Transient, $V_{IN} = 9V$ to $60V$, $1V/ms$, $I_{OUT} = 0A$

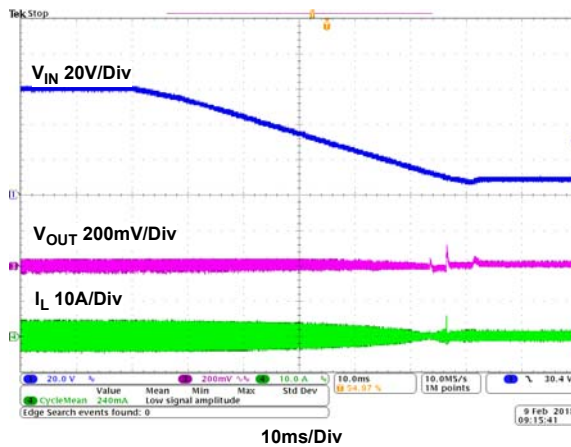

Figure 30. Line Transient, $V_{IN} = 60V$ to $9V$, $1V/ms$, $I_{OUT} = 0A$

5. Revision History

Rev.	Date	Description
1.00	Aug 6, 2018	Corrected BOM for components C12, C13, C41, C42, and C29 on page 10. Updated board pictures and layout files.
0.00	Mar 26, 2018	Initial release

Notice

1. Descriptions of circuits, software and other related information in this document are provided only to illustrate the operation of semiconductor products and application examples. You are fully responsible for the incorporation or any other use of the circuits, software, and information in the design of your product or system. Renesas Electronics disclaims any and all liability for any losses and damages incurred by you or third parties arising from the use of these circuits, software, or information.
2. Renesas Electronics hereby expressly disclaims any warranties against and liability for infringement or any other claims involving patents, copyrights, or other intellectual property rights of third parties, by or arising from the use of Renesas Electronics products or technical information described in this document, including but not limited to, the product data, drawings, charts, programs, algorithms, and application examples.
3. No license, express, implied or otherwise, is granted hereby under any patents, copyrights or other intellectual property rights of Renesas Electronics or others.
4. You shall not alter, modify, copy, or reverse engineer any Renesas Electronics product, whether in whole or in part. Renesas Electronics disclaims any and all liability for any losses or damages incurred by you or third parties arising from such alteration, modification, copying or reverse engineering.
5. Renesas Electronics products are classified according to the following two quality grades: "Standard" and "High Quality". The intended applications for each Renesas Electronics product depends on the product's quality grade, as indicated below.
"Standard": Computers; office equipment; communications equipment; test and measurement equipment; audio and visual equipment; home electronic appliances; machine tools; personal electronic equipment; industrial robots; etc.
"High Quality": Transportation equipment (automobiles, trains, ships, etc.); traffic control (traffic lights); large-scale communication equipment; key financial terminal systems; safety control equipment; etc.
Unless expressly designated as a high reliability product or a product for harsh environments in a Renesas Electronics data sheet or other Renesas Electronics document, Renesas Electronics products are not intended or authorized for use in products or systems that may pose a direct threat to human life or bodily injury (artificial life support devices or systems; surgical implantations; etc.), or may cause serious property damage (space system; undersea repeaters; nuclear power control systems; aircraft control systems; key plant systems; military equipment; etc.). Renesas Electronics disclaims any and all liability for any damages or losses incurred by you or any third parties arising from the use of any Renesas Electronics product that is inconsistent with any Renesas Electronics data sheet, user's manual or other Renesas Electronics document.
6. When using Renesas Electronics products, refer to the latest product information (data sheets, user's manuals, application notes, "General Notes for Handling and Using Semiconductor Devices" in the reliability handbook, etc.), and ensure that usage conditions are within the ranges specified by Renesas Electronics with respect to maximum ratings, operating power supply voltage range, heat dissipation characteristics, installation, etc. Renesas Electronics disclaims any and all liability for any malfunctions, failure or accident arising out of the use of Renesas Electronics products outside of such specified ranges.
7. Although Renesas Electronics endeavors to improve the quality and reliability of Renesas Electronics products, semiconductor products have specific characteristics, such as the occurrence of failure at a certain rate and malfunctions under certain use conditions. Unless designated as a high reliability product or a product for harsh environments in a Renesas Electronics data sheet or other Renesas Electronics document, Renesas Electronics products are not subject to radiation resistance design. You are responsible for implementing safety measures to guard against the possibility of bodily injury, injury or damage caused by fire, and/or danger to the public in the event of a failure or malfunction of Renesas Electronics products, such as safety design for hardware and software, including but not limited to redundancy, fire control and malfunction prevention, appropriate treatment for aging degradation or any other appropriate measures. Because the evaluation of microcomputer software alone is very difficult and impractical, you are responsible for evaluating the safety of the final products or systems manufactured by you.
8. Please contact a Renesas Electronics sales office for details as to environmental matters such as the environmental compatibility of each Renesas Electronics product. You are responsible for carefully and sufficiently investigating applicable laws and regulations that regulate the inclusion or use of controlled substances, including without limitation, the EU RoHS Directive, and using Renesas Electronics products in compliance with all these applicable laws and regulations. Renesas Electronics disclaims any and all liability for damages or losses occurring as a result of your noncompliance with applicable laws and regulations.
9. Renesas Electronics products and technologies shall not be used for or incorporated into any products or systems whose manufacture, use, or sale is prohibited under any applicable domestic or foreign laws or regulations. You shall comply with any applicable export control laws and regulations promulgated and administered by the governments of any countries asserting jurisdiction over the parties or transactions.
10. It is the responsibility of the buyer or distributor of Renesas Electronics products, or any other party who distributes, disposes of, or otherwise sells or transfers the product to a third party, to notify such third party in advance of the contents and conditions set forth in this document.
11. This document shall not be reprinted, reproduced or duplicated in any form, in whole or in part, without prior written consent of Renesas Electronics.
12. Please contact a Renesas Electronics sales office if you have any questions regarding the information contained in this document or Renesas Electronics products.
(Note 1) "Renesas Electronics" as used in this document means Renesas Electronics Corporation and also includes its directly or indirectly controlled subsidiaries.
(Note 2) "Renesas Electronics product(s)" means any product developed or manufactured by or for Renesas Electronics.

(Rev.4.0-1 November 2017)



SALES OFFICES

Renesas Electronics Corporation

<http://www.renesas.com>

Refer to "<http://www.renesas.com/>" for the latest and detailed information.

California Eastern Laboratories, Inc.
4590 Patrick Henry Drive, Santa Clara, California 95054-1817, U.S.A.
Tel: +1-408-919-2500, Fax: +1-408-988-0279

Renesas Electronics Canada Limited
9251 Yonge Street, Suite 8309 Richmond Hill, Ontario Canada L4C 9T3
Tel: +1-905-237-2004

Renesas Electronics Europe Limited
Dukes Meadow, Millboard Road, Bourne End, Buckinghamshire, SL8 5FH, U.K
Tel: +44-1628-651-700

Renesas Electronics Europe GmbH
Arcadiastrasse 10, 40472 Düsseldorf, Germany
Tel: +49-211-6503-0, Fax: +49-211-6503-1327

Renesas Electronics (China) Co., Ltd.
Room 1709 Quantum Plaza, No.27 ZhichunLu, Haidian District, Beijing, 100191 P. R. China
Tel: +86-10-8235-1155, Fax: +86-10-8235-7679

Renesas Electronics (Shanghai) Co., Ltd.
Unit 301, Tower A, Central Towers, 555 Langao Road, Putuo District, Shanghai, 200333 P. R. China
Tel: +86-21-2226-0888, Fax: +86-21-2226-0999

Renesas Electronics Hong Kong Limited
Unit 1601-1611, 16/F., Tower 2, Grand Century Place, 193 Prince Edward Road West, Mongkok, Kowloon, Hong Kong
Tel: +852-2265-6688, Fax: +852 2886-9022

Renesas Electronics Taiwan Co., Ltd.
13F, No. 363, Fu Shing North Road, Taipei 10543, Taiwan
Tel: +886-2-8175-9600, Fax: +886 2-8175-9670

Renesas Electronics Singapore Pte. Ltd.
80 Bendemeer Road, Unit #06-02 Hyflux Innovation Centre, Singapore 339949
Tel: +65-6213-0200, Fax: +65-6213-0300

Renesas Electronics Malaysia Sdn.Bhd.
Unit 1207, Block B, Menara Amcorp, Amcorp Trade Centre, No. 18, Jln Persiaran Barat, 46050 Petaling Jaya, Selangor Darul Ehsan, Malaysia
Tel: +60-3-7955-9390, Fax: +60-3-7955-9510

Renesas Electronics India Pvt. Ltd.
No.77C, 100 Feet Road, HAL 2nd Stage, Indiranagar, Bangalore 560 038, India
Tel: +91-80-67208700, Fax: +91-80-67208777

Renesas Electronics Korea Co., Ltd.
17F, KAMCO Yangjae Tower, 262, Gangnam-daero, Gangnam-gu, Seoul, 06265 Korea
Tel: +82-2-558-3737, Fax: +82-2-558-5338