

ISL854102DEMO3Z

User's Manual: Demonstration Board

Industrial Analog and Power

ISL854102DEMO3Z

Demonstration Board

UG137
Rev.0.00
Sep 12, 2017

1. Overview

The ISL854102DEMO3Z board uses the ISL854102 in an isolated buck-boost configuration. The primary output is configured to be -5V and the secondary output is +5V. The board is used to demonstrate the performance of the [ISL854102](#) wide V_{IN} synchronous buck regulator, configured as a buck-boost converter to support an inverting primary output and a non-inverting secondary output.

The ISL854102 is the higher current version of the family of ISL85410 (1A), ISL854102 (1.2A), and ISL85418 (0.8A), which are offered in a 4mmx3mm 12 Ld DFN package with 1mm maximum height.

1.1 Key Features

- Wide input voltage range of 3.5V to 40V
- Synchronous operation for high efficiency
- Integrated high-side and low-side NMOS devices
- Internal fixed (500kHz) or adjustable (300kHz to 2MHz) switching frequency
- Continuous output current up to 0.5A at primary output and 0.5A at secondary output
- Internal or external soft-start
- Minimal external components required
- Power-good and enable functions available

1.2 Specifications

These boards have been configured and optimized for the following operating conditions:

- $V_{IN} = 24V$
- $V_{OUT_PRI} = -5V$, $V_{OUT_SEC} = +5V$
- $I_{MAX_PRI} = 0.5A$, $I_{MAX_SEC} = 0.5A$
- $f_{SW} = 500kHz$

1.3 Ordering Information

Part Number	Description
ISL854102DEMO3Z	ISL854102 demonstration board

1.4 Related Literature

- For a full list of related documents, visit our website
 - [ISL854102](#) product page

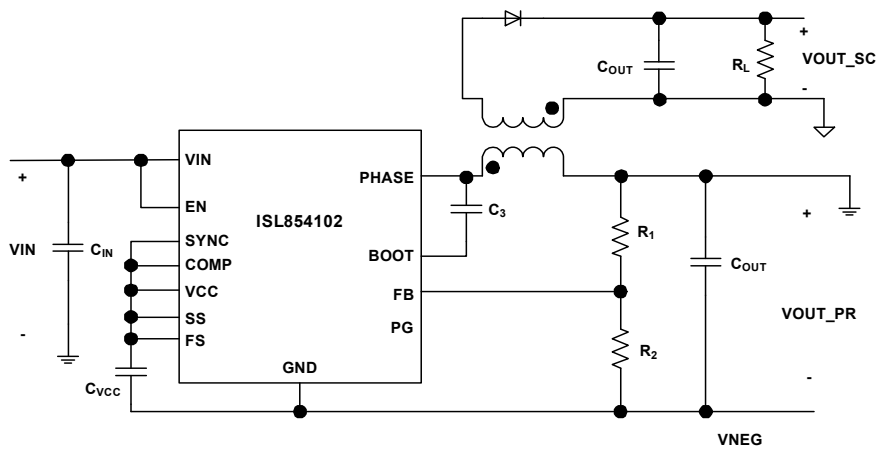

Figure 1. Block Diagram

2. Functional Description

2.1 Recommended Equipment

The following materials are recommended for testing:

- 0V to 50V power supply with at least 2A source current capability
- Resistive loads capable of sinking current up to 1A
- Digital Multimeters (DMMs)
- 100MHz quad-trace oscilloscope

2.2 Quick Setup Guide

- (1) Ensure that the circuit is correctly connected to the supply and loads before applying any power.
- (2) Connect the bias supply to VIN, the plus terminal to VIN, and the negative return to GND.
- (3) Verify that SW1 is in the ON position.
- (4) Turn on the power supply.
- (5) Verify the output voltage is -5V for V_{NEG} and between 5.0V to 5.5V for V_{OUT_SC}.

2.3 Evaluating the Other Output Voltage

The ISL854102DEMO3Z board outputs are preset to ±5V; however, output voltages can be adjusted from 0.6V to 15V. The output voltage programming resistor, R₂, will depend on the desired output voltage of the regulator and the value of the feedback resistor R₁, as shown in [Equation 1](#).

$$R_2 = R_1 \left(\frac{0.6}{V_{OUT} - 0.6} \right) \quad (\text{EQ. 1})$$

If the output voltage desired is 0.6V, then R₁ is shorted. Note that if V_{OUT} is less than 1.8V, the switching frequency and compensation must be changed for 300kHz operation due to minimum on-time limitation. Refer to the [ISL854102](#) datasheet for further information.

[Table 1](#) shows the component selection that should be used for the respective V_{OUT}.

Table 1. External Component Selection

V _{OUT} (V)	L ₁ (μH)	C ₅ + C ₆ (μF)	R ₁ (kΩ)	R ₂ (kΩ)	C ₄ (pF)	R ₁₂ (kΩ)	R ₃ (kΩ)	C ₇ (pF)	C ₈ (pF)	R ₁₅ (kΩ)
12	47	2x22	90.9	4.75	100	DNP (Note 1)	200	2200	100	1.5
5	22	47+22	90.9	12.4	220	DNP (Note 1)	80.6	2200	100	0.56
3.3	22	47+22	90.9	20	100	DNP (Note 1)	80.6	2200	100	0.3

Note:

1. Connect FS to V_{CC}.

2.4 Frequency Control

The ISL854102 has an FS pin that controls the frequency of operation. Programmable frequency allows for optimization between efficiency and external component size. It also allows low frequency operation for low V_{OUTS} when minimum on-time would limit the operation otherwise. The default switching frequency is 500kHz when FS is tied to V_{CC} (R₁₃ = 0). By removing R₁₃, the switching frequency can be changed from 300kHz (R₁₄ = 340k) to 2MHz (R₁₄ = 32.4k). Refer to [ISL854102](#) datasheet for calculating the value of R₁₄. Do not leave this pin floating.

2.5 Disabling/Enabling Function

The ISL854102DEMO3Z board contains a SW1 switch that enables or disables the part, thus allowing low quiescent current state. [Table 2](#) details this function.

Table 2. Switch Settings

S1	On/Off Control
ON	Enable V_{OUT}
OFF	Disable V_{OUT}

2.6 SYNC Control

The ISL854102DEMO3Z board has a SYNC pin that allows an external synchronization frequency to be applied. The default board configuration has $R_9 = 200k$ connected to V_{CC} , which defaults to PWM operation mode and also to the preselected switching frequency set by R_{14} . See the [ISL854102](#) datasheet and previous section [“Frequency Control” on page 4](#) for details.

2.7 Soft-Start/COMP Control

R_{11} selects between internal ($R_{11} = 0$) and external soft-start. R_8 selects between internal ($R_8 = 0$) and external compensation. For applications in which repetitive restarts of the IC are required, a $350k\Omega$ resistor in parallel to CSS is recommended to allow its fast discharge. Refer to the pin description table of the [ISL854102](#) datasheet.

3. PCB Layout Guidelines

3.1 ISL854102DEMO3Z Demonstration Board

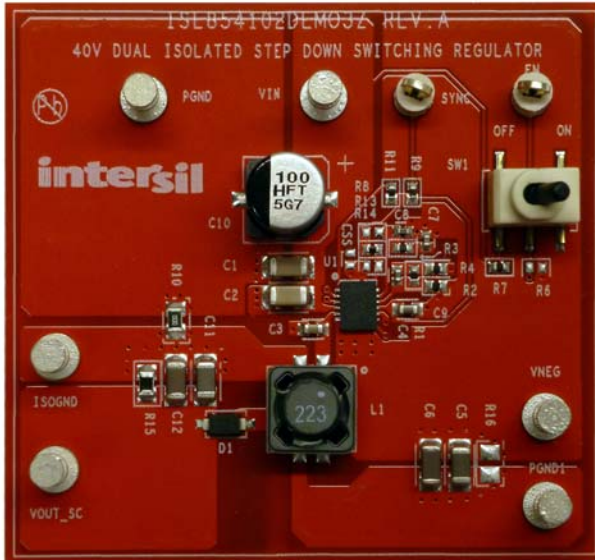

Figure 2. ISL854102DEMO3Z Top



Figure 3. ISL854102DEMO3Z Bottom

3.2 ISL854102DEMO3Z Schematic

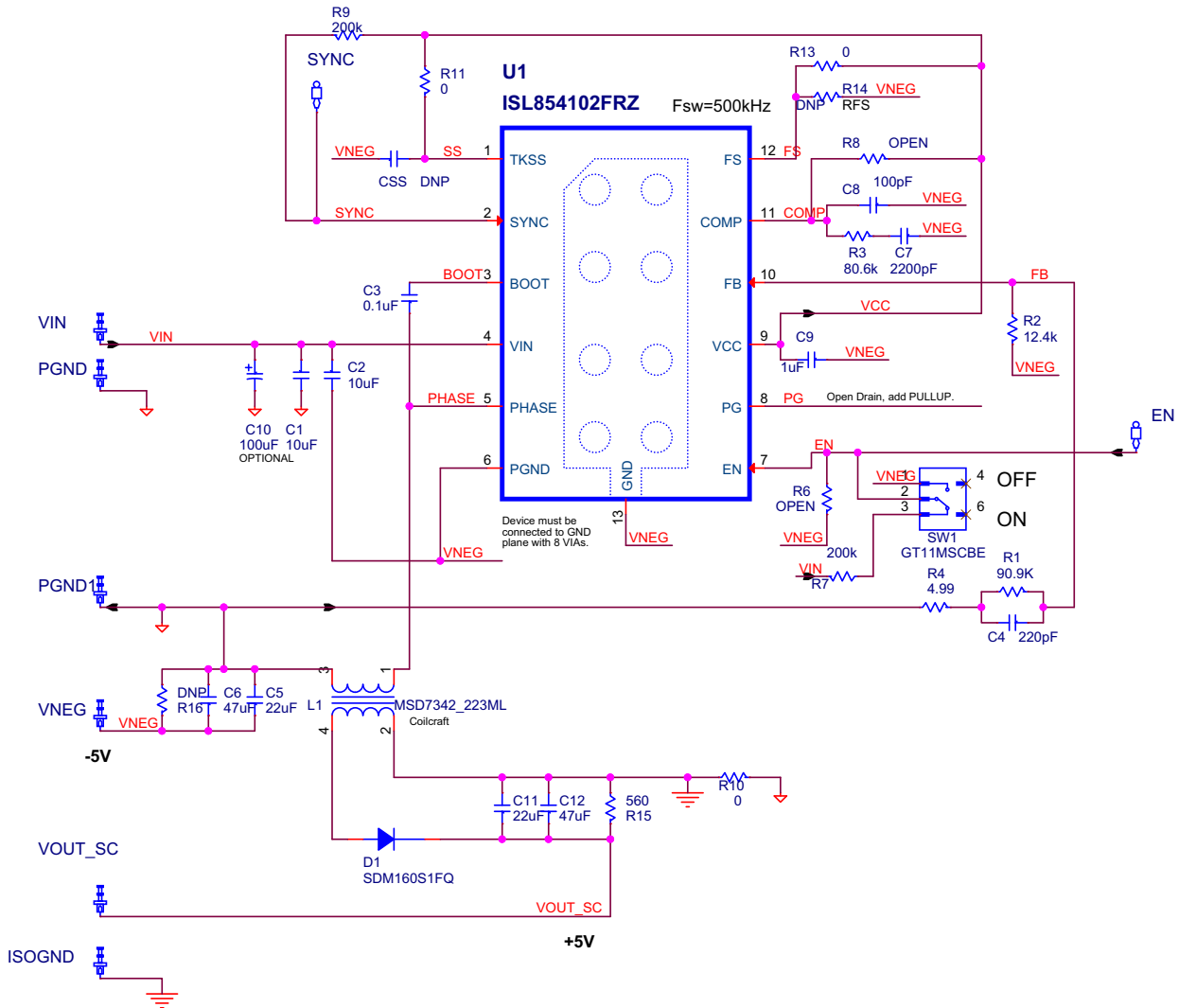

Figure 4. Schematic

3.3 Bill of Materials

Manufacturer Part	Qty	Reference Designator	Description	Manufacturer
EEE-FTH101XAP	1	C10 (Optional)	CAP ALUM 100 μ F 20% 50V SMD	PANASONIC
C3216X5R1H106K	2	C1, C2	CAP, SMD, 1206, 10 μ F, 50V, 10%, X5R, ROHS	TDK
06035C104KAT2A	1	C3	CAP, SMD, 0603, 0.1 μ F, 50V, 10%, X7R, ROHS	AVX
ECU-E1H221JCQ	1	C4	CAP, SMD, 0402, 220pF, 50V, 1%, NP0, ROHS	PANASONIC
CGA5L1X5R1C226M160AC	2	C5, C11	CAP, SMD, 1206, 22 μ F, 16V, 20%, X5R, ROHS	TDK
C3216X5R0J476M	2	C6, C12	CAP, SMD, 1206, 47 μ F, 16V, 20%, X5R, ROHS	TDK
0402C222JAT	1	C7	CAP, SMD, 0402, 2200pF, 50V, 5%, NP0, ROHS	AVX
04025A101JAT2A	1	C8	CAP, SMD, 0402, 100pF, 50V, 1%, NP0, ROHS	AVX
GRM188R61C105KA12D	1	C9	CAP, SMD, 0603, 1 μ F, 16V, 10%, X5R, ROHS	MURATA
1514-2	6	VIN, PGND, PGND1, ISOGND, VNEG, VOUT_SC	CONN-TURRET, TERMINAL POST, TH, ROHS	KEYSTONE
5007	2	EN, SYNC	CONN-MINI TEST POINT, VERTICAL, WHITE, ROHS	KEYSTONE
310-43-164-41-001000	2	J1, J2	CCONN-BRD-BRD, TH, 1x2, SKTSTRIP-1x64, 2.54mm, TIN, ROHS	MILL-MAX
SDM160S1FQ	1	D1	SCHOTTKY DIODE, SMD, 2P, SOD-123F, 60V, 1A, ROHS	DIODES, INC.
ISL854102FRZ for ISL854102DEMO3Z	1	U1	IC 40V BUCK REGULATOR, 12P, DFN, 3x4, ROHS	INTERSIL
MSD7342-223ML	1	L1	COUPLED INDUCTOR, SMD, 4P, 22 μ H, ROHS	COILCRAFT
CRCW040290K9FKED	1	R1	RES, SMD, 0402, 90.9k, 1/16W, 1%, TF, ROHS	VISHAY/DALE
CRCW040212K4FKED	1	R2	RES, SMD, 0402, 12.4k, 1/16W, 1%, TF, ROHS	VISHAY/DALE
CR0402-16W-8062FT	1	R3	RES, SMD, 0402, 80.6k, 1/16W, 1%, TF, ROHS	VENKEL
CR0402-16W-4R99FT	1	R4	RES, SMD, 0402, 4.99 Ω , 1/10W, 1%, TF, ROHS	VENKEL
MCR01MZPF2003	2	R7, R9	RES, SMD, 0402, 200k, 1/16W, 1%, TF, ROHS	ROHM
	0	R6, R8, R14	RES, SMD, 0402, DNP-PLACE HOLDER, ROHS	
CR0402-16W-000T	1	R11, R13	RES, SMD, 0402, 0 Ω , 1/16W, TF, ROHS	VENKEL
CR0805-10W-000T	1	R10	RES, SMD, 0805, 0 Ω , 1/8W, TF, ROHS	VENKEL
ERJ-P6WF5600V	1	R15	RES, SMD, 0805, 560 Ω , 1/2W, 1%, TF, ROHS	PANASONIC
	1	R16	RES, SMD, 0805, DNP-PLACE HOLDER, ROHS	PANASONIC
GT11MSCBE	1	SW1	SWITCH-TOGGLE, SMD, 6PIN, SPDT, 2 POS, ON-NONE-ON, ROHS	ITT INDUSTRIES/ C&K DIVISION
D810 (212403-012)	1	PLACE ASSY IN BAG	BAG, STATIC, 3x5, ZIP LOC	INTERSIL COMMON STOCK

3.4 Board Layout

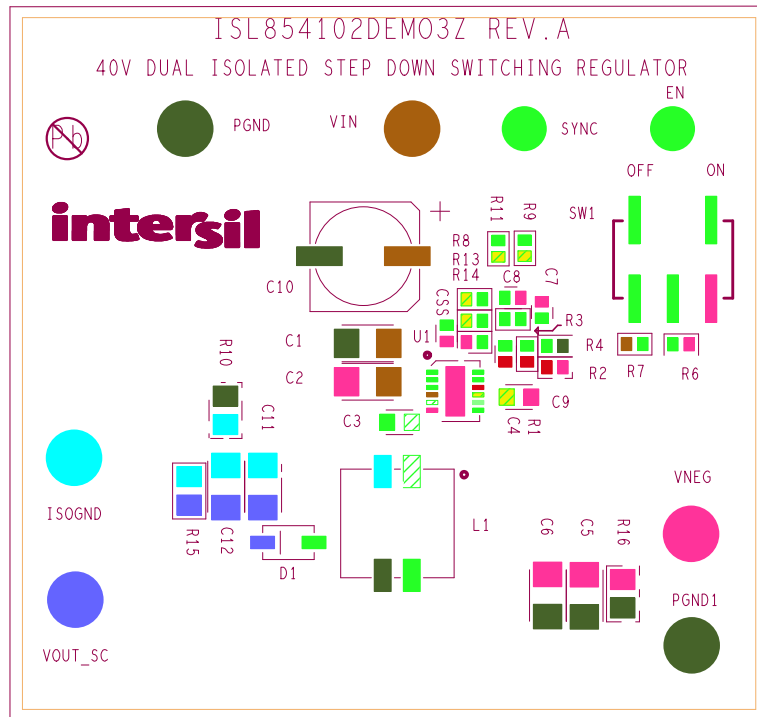

Figure 5. Silkscreen Top

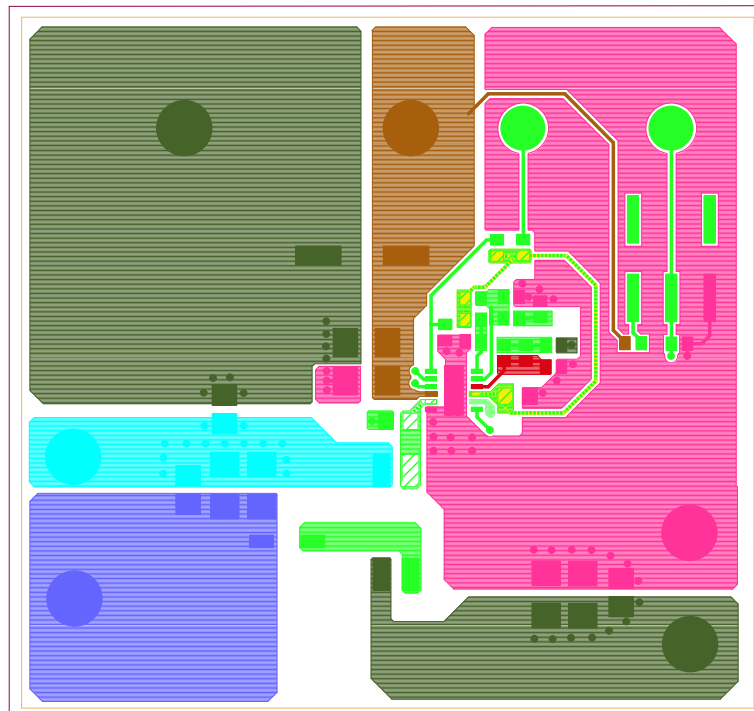

Figure 6. Layer 1

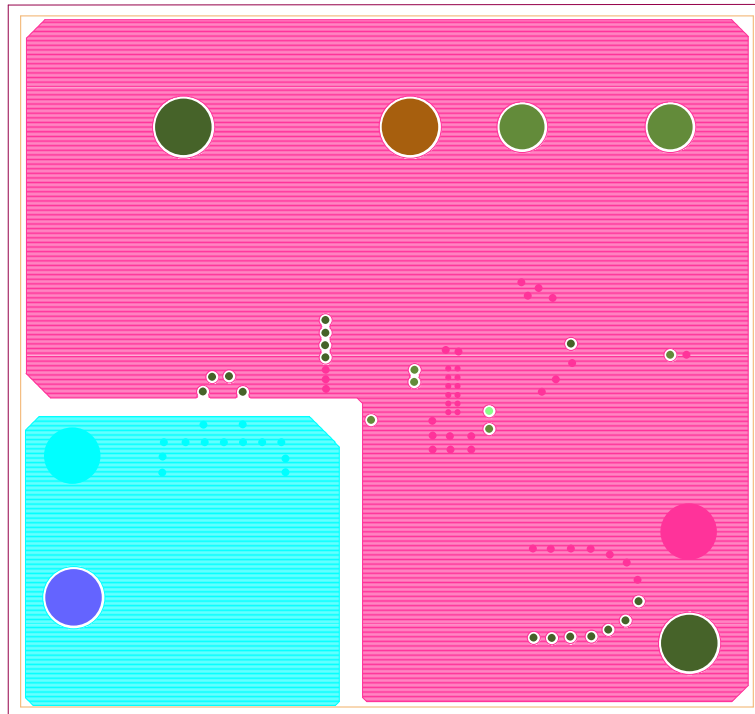

Figure 7. Layer 2

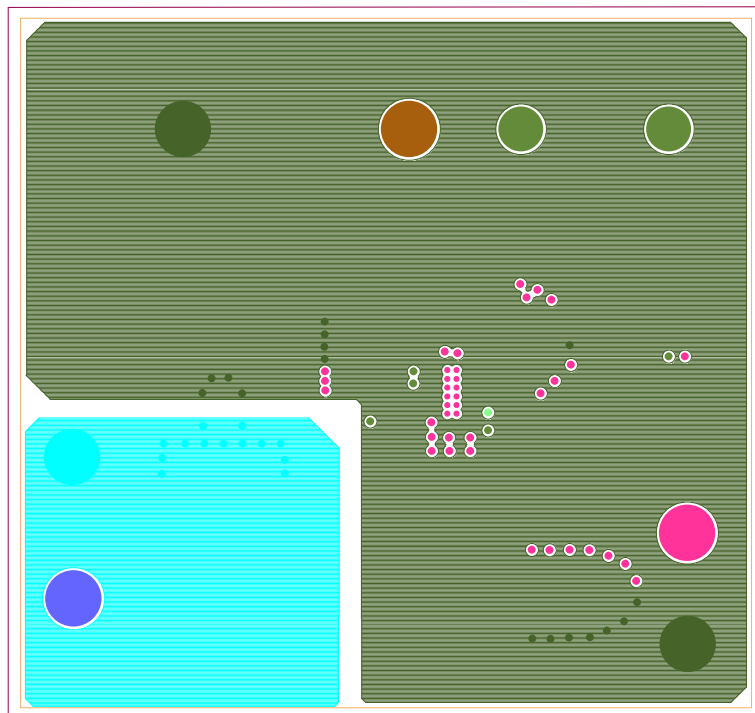

Figure 8. Layer 3

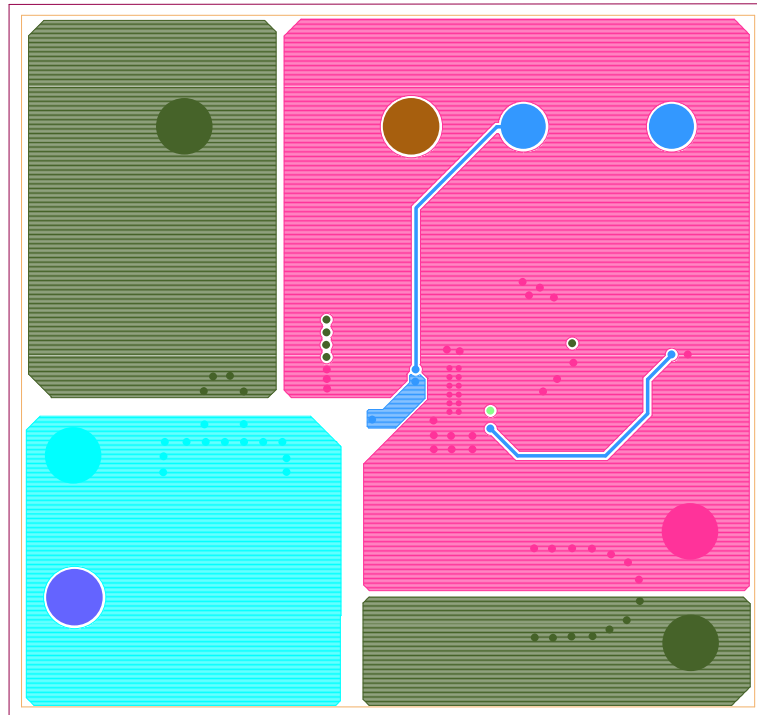

Figure 9. Layer 4

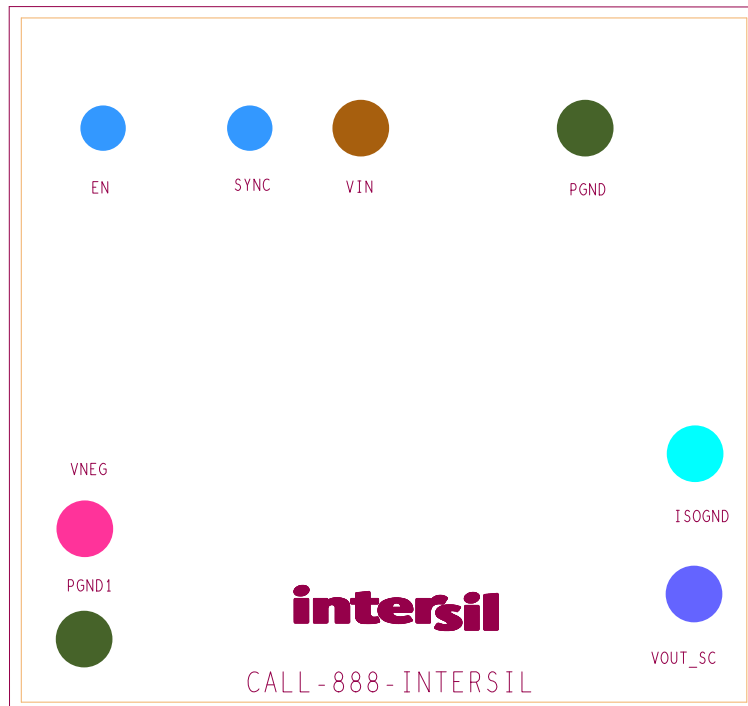

Figure 10. Silkscreen Bottom

4. Typical Performance Curves

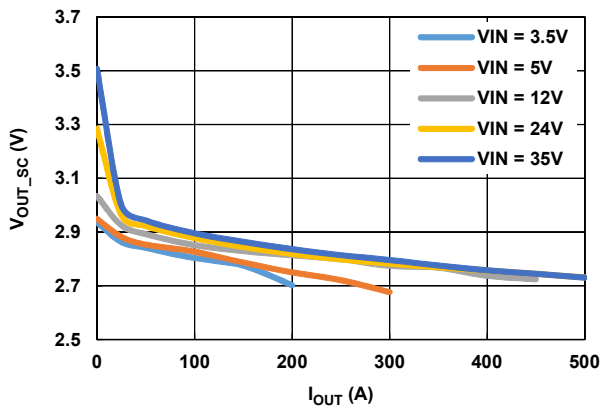

Figure 11. V_{OUT_SC} Regulation vs I_{OUT} ($V_{OUT} = 3.3V$)

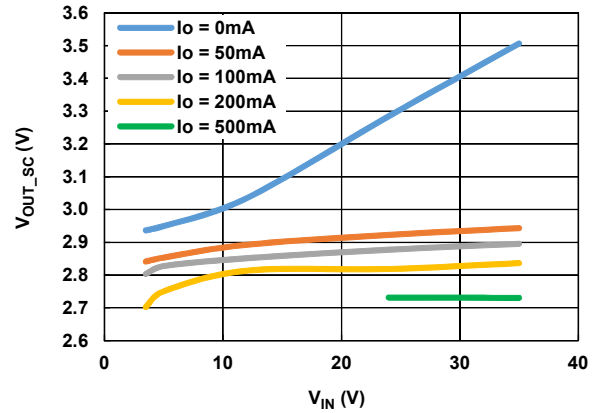

Figure 12. V_{OUT_SC} Regulation vs V_{IN} ($V_{OUT} = 3.3V$)

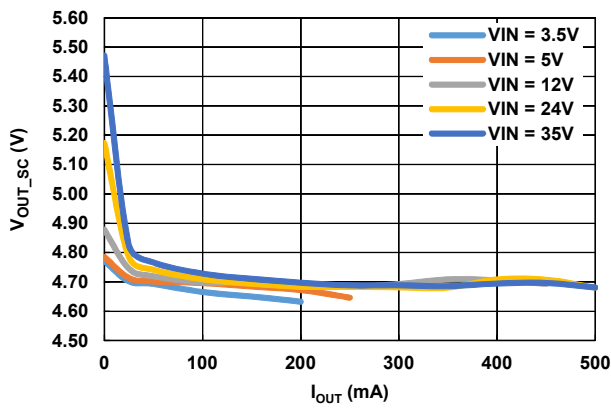

Figure 13. V_{OUT_SC} Regulation vs I_{OUT} ($V_{OUT} = 5V$)

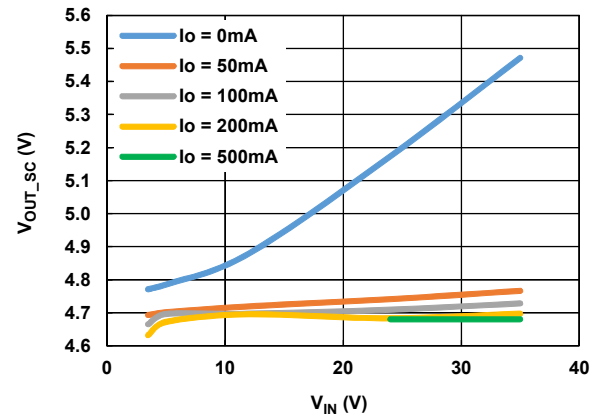

Figure 14. V_{OUT_SC} Regulation vs V_{IN} ($V_{OUT} = 5V$)

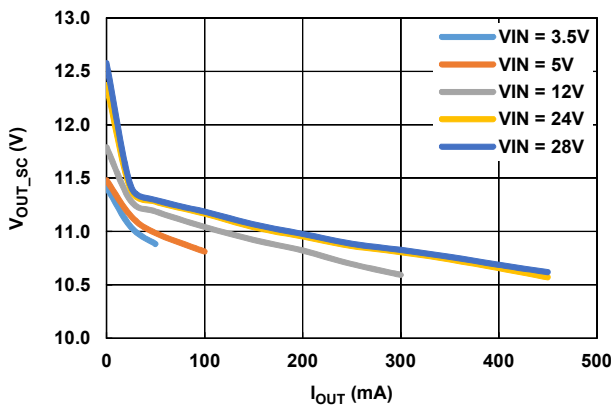

Figure 15. V_{OUT_SC} Regulation vs I_{OUT} ($V_{OUT} = 12V$)

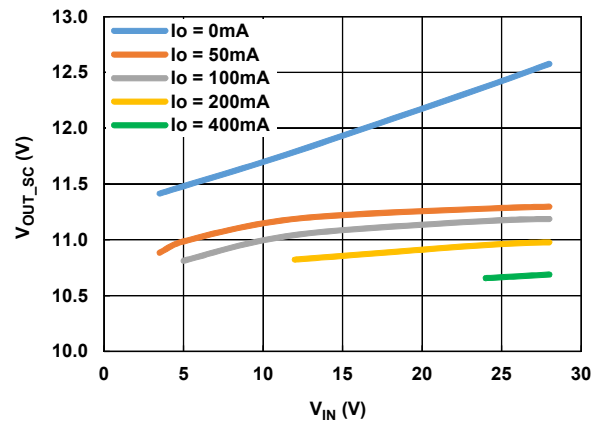

Figure 16. V_{OUT_SC} Regulation vs V_{IN} ($V_{OUT} = 12V$)

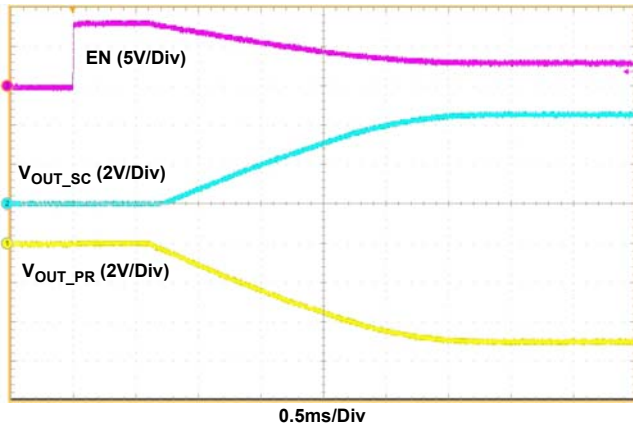

Figure 17. Start-Up by EN ($V_{IN} = 3.5V$, $V_{OUT_PR} = -5V$, $V_{OUT_SC} = +5V$ at $I_{OUT_PR} = 0.1A$, $I_{OUT_SC} = 0.1A$, FCCM)

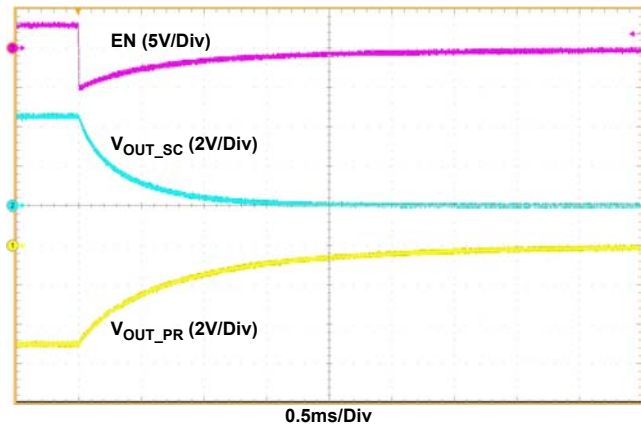

Figure 18. Shut-Down by EN ($V_{IN} = 3.5V$, $V_{OUT_PR} = -5V$, $V_{OUT_SC} = +5V$ at $I_{OUT_PR} = 0.1A$, $I_{OUT_SC} = 0.1A$, FCCM)

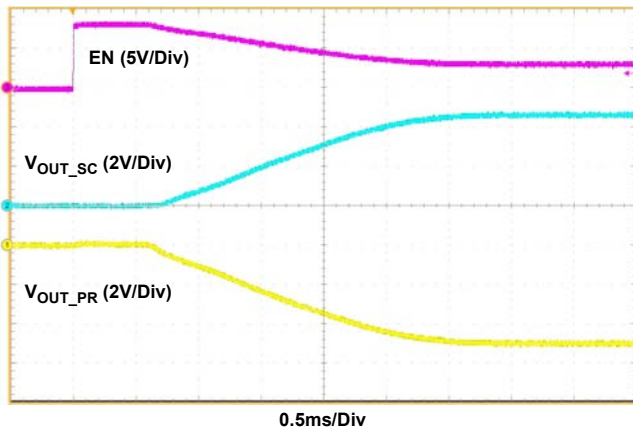

Figure 19. Start-Up by EN ($V_{IN} = 24V$, $V_{OUT_PR} = -5V$, $V_{OUT_SC} = +5V$ at $I_{OUT_PR} = 0.2A$, $I_{OUT_SC} = 0.2A$, FCCM)

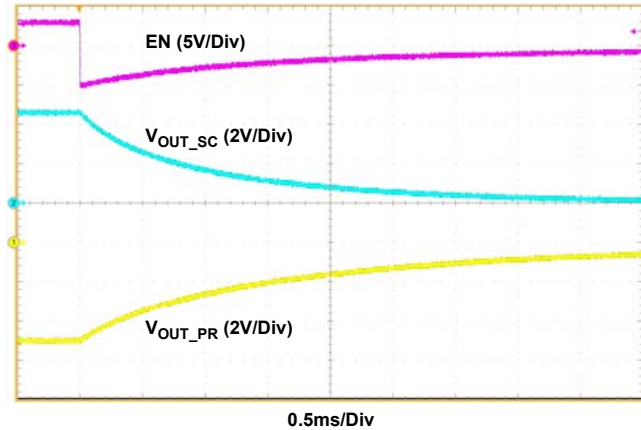

Figure 20. Shut-Down by EN ($V_{IN} = 24V$, $V_{OUT_PR} = -5V$, $V_{OUT_SC} = +5V$ at $I_{OUT_PR} = 0.2A$, $I_{OUT_SC} = 0.2A$, FCCM)

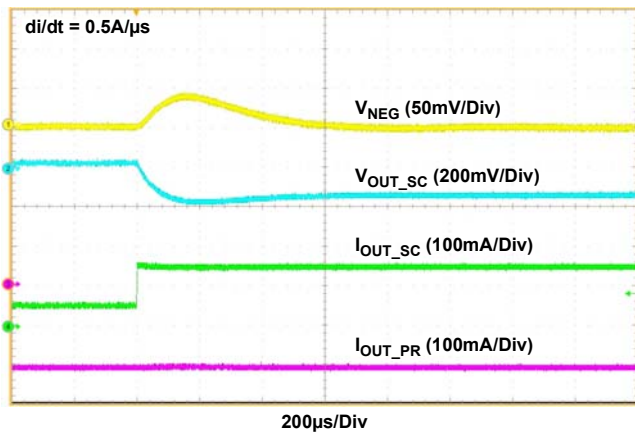

Figure 21. Loading Transient ($V_{IN} = 3.5V$, $V_{OUT_PR} = -5V$, $V_{OUT_SC} = +5V$ at $I_{OUT_PR} = -200mA$, $I_{OUT_SC} = 50mA$ to $150mA$, FCCM)

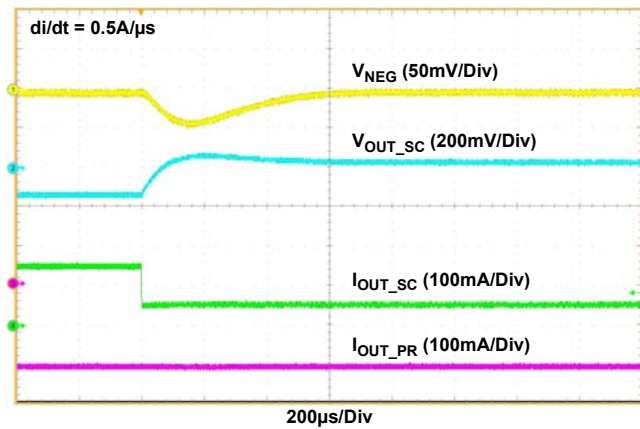

Figure 22. Unloading Transient ($V_{IN} = 3.5V$, $V_{OUT_PR} = -5V$, $V_{OUT_SC} = +5V$ at $I_{OUT_PR} = -200mA$, $I_{OUT_SC} = 150mA$ to $50mA$, FCCM)

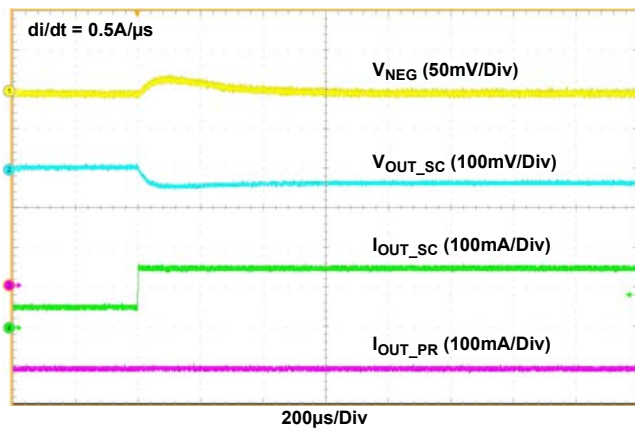

Figure 23. Loading Transient ($V_{IN} = 24V$, $V_{OUT_PR} = -5V$, $V_{OUT_SC} = +5V$ at $I_{OUT_PR} = -200mA$, $I_{OUT_SC} = 50mA$ to $150mA$, FCCM)

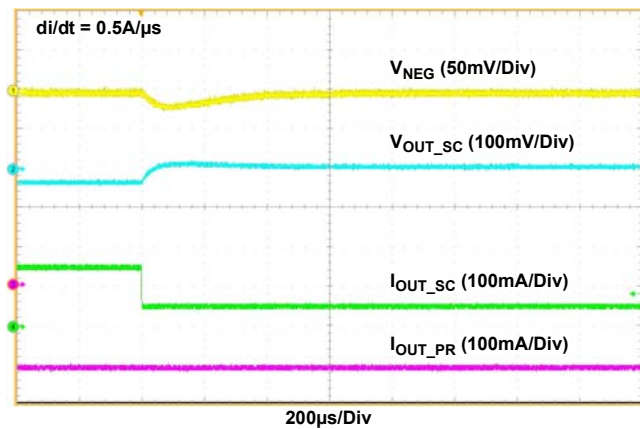

Figure 24. Unloading Transient ($V_{IN} = 24V$, $V_{OUT_PR} = -5V$, $V_{OUT_SC} = +5V$ at $I_{OUT_PR} = -200mA$, $I_{OUT_SC} = 150mA$ to $50mA$, FCCM)

5. Revision History

Rev.	Date	Description
0.00	Sep 12, 2017	Initial release

© Copyright Intersil Americas LLC 2017. All Rights Reserved.
All trademarks and registered trademarks are the property of their respective owners.

Intersil Corporation reserves the right to make changes in circuit design, software and/or specifications at any time without notice. Accordingly, the reader is cautioned to verify that the document is current before proceeding.

For information regarding Intersil Corporation and its products, see www.intersil.com