

ISL85415DEMO1Z

Wide VIN 500mA Synchronous Buck Regulator

AN1860
Rev 2.00
May 16, 2014

Description

The ISL85415DEMO1Z kit is intended for use for point-of-load applications sourcing from 3V to 36V. The kit is used to demonstrate the performance of the ISL85415 Wide VIN Low Quiescent Current High Efficiency Sync Buck Regulator with 500mA output current.

The ISL85415 is offered in a 4mmx3mm 12 Ld DFN package with 1mm maximum height. The converter occupies 1.516 cm² area.

Key Features

- Wide input voltage range 3V to 36V
- Synchronous operation for high efficiency
- No compensation required
- Integrated high-side and low-side NMOS devices
- Selectable PFM or forced PWM mode at light loads
- Internal fixed (500kHz) or adjustable switching frequency 300kHz to 2MHz
- Continuous output current up to 500mA
- Internal or external soft-start
- Minimal external components required
- Power-good and enable functions available

Recommended Equipment

The following materials are recommended to perform testing:

- 0V to 50V power supply with at least 2A source current capability
- Electronic Loads capable of sinking current up to 1.5A
- Digital multimeters (DMMs)
- 100MHz quad-trace oscilloscope
- Signal generator

Quick Setup Guide

1. Ensure that the circuit is correctly connected to the supply and loads prior to applying any power.
2. Connect the bias supply to VIN, the plus terminal to VIN (P4) and the negative return to GND (P5).
3. Turn on the power supply.
4. Verify the output voltage is 3.3V for V_{OUT}.

Evaluating the Other Output Voltage

The ISL85415DEMO1Z kit output is preset to 3.3V; however, output voltages can be adjusted from 0.6V to 15V. The output voltage programming resistor, R₂, will depend on the desired output voltage of the regulator and the value of the feedback resistor R₁, as shown in [Equation 1](#).

$$R_2 = R_1 \left(\frac{0.6}{V_{OUT} - 0.6} \right) \quad (\text{EQ. 1})$$

If the output voltage desired is 0.6V, then R₁ is shorted. Please note that if V_{OUT} is less than 1.8V, the switching frequency and compensation must be changed for 300kHz operation due to minimum on-time limitation. Please refer to datasheet [ISL85415](#) for further information.

[Table 1](#) on [page 2](#) shows the component selection that should be used for the respective V_{OUTs}.



FIGURE 1. FRONT OF EVALUATION BOARD ISL85415DEMO1Z

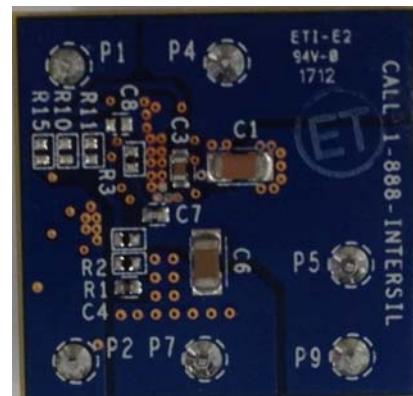

FIGURE 2. BACK OF EVALUATION BOARD ISL85415DEMO1Z

TABLE 1. EXTERNAL COMPONENT SELECTION

V _{OUT} (V)	L ₁ (μH)	C _{OUT} (μF)	R ₁ (kΩ)	R ₂ (kΩ)	C _{FB} (pF)	R _{FS} (kΩ)	R _{COMP} (kΩ)	C _{COMP} (pF)
12	45	10	90.9	4.75	22	115	100	470
5	22	2x22	90.9	12.4	100	120	100	470
3.3	22	2x22	90.9	20	100	120	100	470
2.5	22	2x22	90.9	28.7	100	120	100	470
1.8	22	22	100	50	22	120	50	470

Frequency Control

The ISL85415 has an FS pin that controls the frequency of operation. Programmable frequency allows for optimization between efficiency and external component size. It also allows low frequency operation for low V_{OUTS} when minimum on time would limit the operation otherwise. Default switching frequency is 500kHz when FS is tied to V_{CC} (R₁₀ = 0). By removing R₁₀ the switching frequency could be changed from 300kHz (R₁₂ = 340k) to 2MHz (R₁₂ = 32.4k). Please refer to datasheet [ISL85415](#) for calculating the value of R₁₀. Do not leave this pin floating.

Disabling/Enabling Function

ISL85415DEMO1Z board has EN pin tied to VCC via R7. This keeps the part enabled all the time. To disable the part, remove R7 and populate R8 with a 0Ω resistor.

SYNC Control

The ISL85415 evaluation board has a SYNC pin that allows external synchronization frequency to be applied. Default board configuration has R₆ = 200k to V_{CC}, which defaults to PWM operation mode and also to the pre-selected switching frequency set by R₁₂ (see datasheet and previous section "[Frequency Control](#)" for details). If this pin is tied to GND the IC will operate in PFM mode. For PFM operation, remove R₆ and populate R₉ with 0Ω resistor.

Soft-Start /COMP Control

R₁₅ selects between internal (R₁₅ = 0) and external soft-start. R₁₁ selects between internal (R₁₁ = 0) and external compensation. Please refer to Pin Description Table (Page 3) of the [ISL85415](#) datasheet.

ISL85415DEMO1Z Schematic

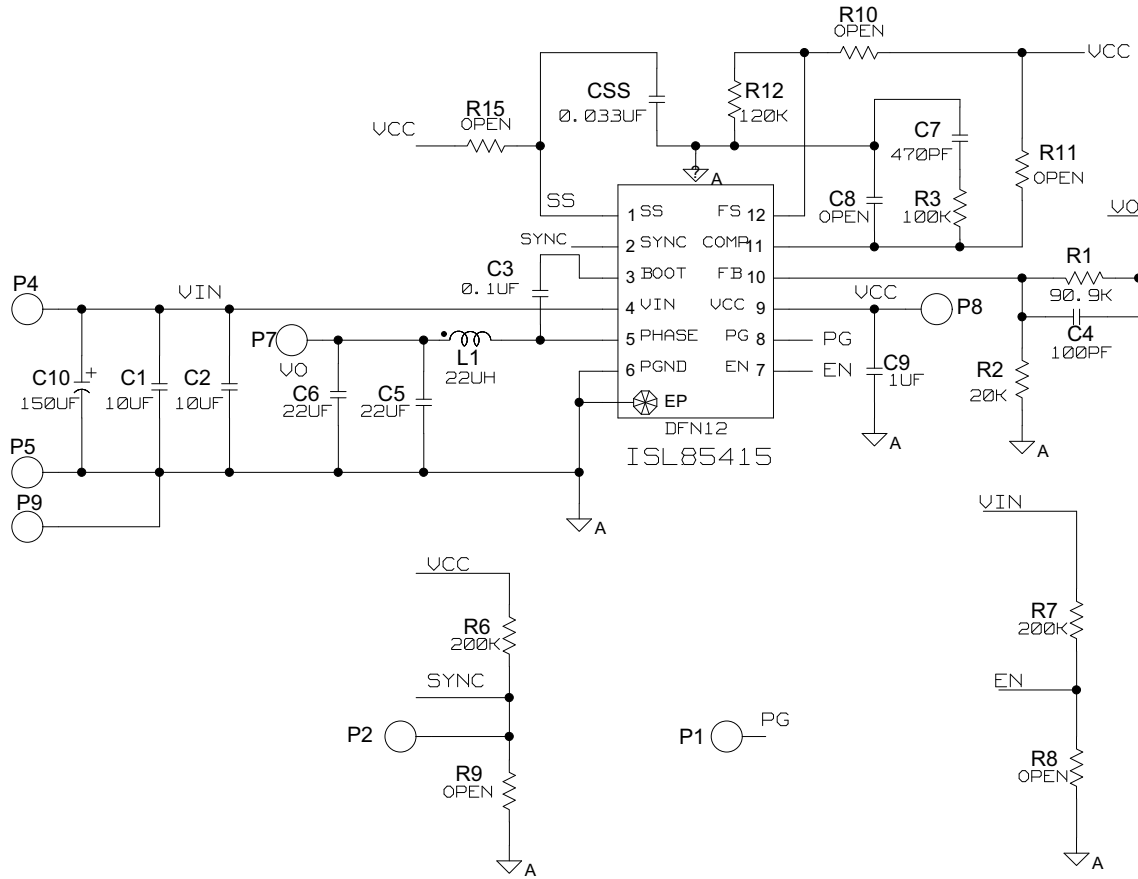

NOTE: If the IC is used in an application where the input test leads have large parasitic inductance, the input electrolytic capacitor C10 may be added to prevent transient voltages on the input pin.

ISL85415DEMO1Z Bill of Materials

PART NUMBER	QTY	UNIT	REFERENCE DESIGNATOR	DESCRIPTION	MANUFACTURER	MANUFACTURER PART
ISL85400EVAL2ZREVAPCB	1	ea	LABEL-RENAME BOARD	PWB-PCB, ISL85400EVAL2Z, REVA, ROHS	INTERSIL	ISL85400EVAL2ZREVAPCB
EEE-FK1H151P-T (DNP)	1	ea	C10 (OPTIONAL)	CAP, SMD, 10.3mm, 150µF, 50V, 20%, ROHS, ALUM.ELEC.	PANASONIC	EEE-FK1H151P
H1044-00101-50V5-T	1	ea	C4	CAP, SMD, 0402, 100pF, 50V, 5%, COG, ROHS	MURATA	GRM1555C1H101JZ01D
H1044-00333-16V10-T	1	ea	CSS	CAP, SMD, 0402, 33000pF, 16V, 10%, X7R, ROHS	MURATA	GRM36X7R333K016AQ
H1044-00471-50V10-T	1	ea	C7	CAP, SMD, 0402, 470pF, 50V, 10%, X7R, ROHS	PANASONIC	ECJ-0EB1H471K
H1044-DNP	0	ea	C8	CAP, SMD, 0402, DNP-PLACE HOLDER, ROHS		
H1045-00104-50V10-T	1	ea	C3	CAP, SMD, 0603, 0.1µF, 50V, 10%, X7R, ROHS	AVX	06035C104KAT2A
H1045-00105-16V10-T	1	ea	C9	CAP, SMD, 0603, 1µF, 16V, 10%, X5R, ROHS	MURATA	GRM188R61C105KA12D
H1065-00106-50V10-T	2	ea	C1, C2	CAP, SMD, 1206, 10µF, 50V, 10%, X5R, ROHS	TDK	C3216X5R1H106K
H1065-00226-6R3V10-T	2	ea	C5, C6	CAP, SMD, 1206, 22µF, 6.3V, 10%, X5R, ROHS	MURATA	GRM31CR60J226KE19L
74408943220	1	ea	L1	COIL-PWR INDUCTOR, SMD, 4.8mm, 22µH, 20%, 1.1A, ROHS	Würth Electronics	74408943220
5000	2	ea	P4, P7	CONN-MINI TEST PT, VERTICAL, RED, ROHS	KEYSTONE	5000
5001	2	ea	P5, P9	CONN-MINI TEST PT, VERTICAL, BLK, ROHS	KEYSTONE	5001
5002	2	ea	P1, P2	CONN-MINI TEST POINT, VERTICAL, WHITE, ROHS	KEYSTONE	5002
ISL85415FRZ	1	ea	U1	IC-500mA BUCK REGULATOR, 12P, DFN, 3x4, ROHS	INTERSIL	ISL85415FRZ
H2510-01003-1/16W1-T	1	ea	R3	RES, SMD, 0402, 100k, 1/16W, 1%, TF, ROHS	PANASONIC	ERJ2RKF1003
H2510-01203-1/16W1-T	1	ea	R12	RES, SMD, 0402, 120k, 1/16W, 1%, TF, ROHS	ROHM	MCR01MZPF1203
H2510-02002-1/16W1-T	1	ea	R2	RES, SMD, 0402, 20k, 1/16W, 1%, TF, ROHS	PANASONIC	ERJ2RKF2001
H2510-02003-1/16W1-T	2	ea	R6, R7	RES, SMD, 0402, 200k, 1/16W, 1%, TF, ROHS	ROHM	MCR01MZPF2003
H2510-09092-1/16W1-T	1	ea	R1	RES, SMD, 0402, 90.9k, 1/16W, 1%, TF, ROHS	VISHAY/DALE	CRCW040290K9FKED

ISL85415DEMO1Z Bill of Materials (Continued)

PART NUMBER	QTY	UNIT	REFERENCE DESIGNATOR	DESCRIPTION	MANUFACTURER	MANUFACTURER PART
H2510-DNP	0	ea	R8-R11, R15	RES, SMD, 0402, DNP, DNP, DNP, TF, ROHS		
2X3-STATIC-BAG	1	ea	PLACE ASSY IN BAG	BAG, STATIC, 2x3, ZIP LOC	TBD	S-6509
LABEL-DATE CODE	1	ea	AFFIX TO BACK OF PCB	LABEL-DATE CODE_BOM REV#_SERIAL# LABEL ON ZIL & QUEL	INTERSIL	LABEL-DATE CODE
LABEL-RENAME BOARD	1	ea	RENAME TOP PCB TO: ISL85415DEMO1Z	LABEL, TO RENAME BOARD	INTERSIL	LABEL-RENAME BOARD

ISL85415DEMO1Z Board Layout

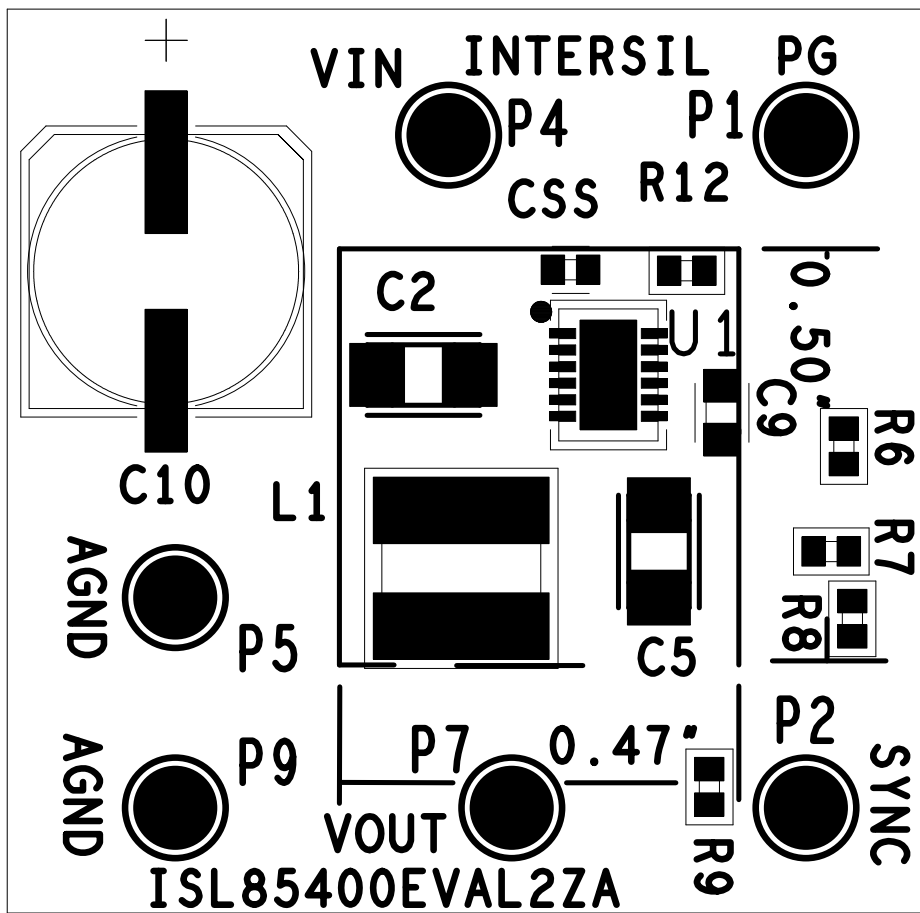

FIGURE 3. SILK SCREEN TOP

ISL85415DEMO1Z Board Layout (Continued)

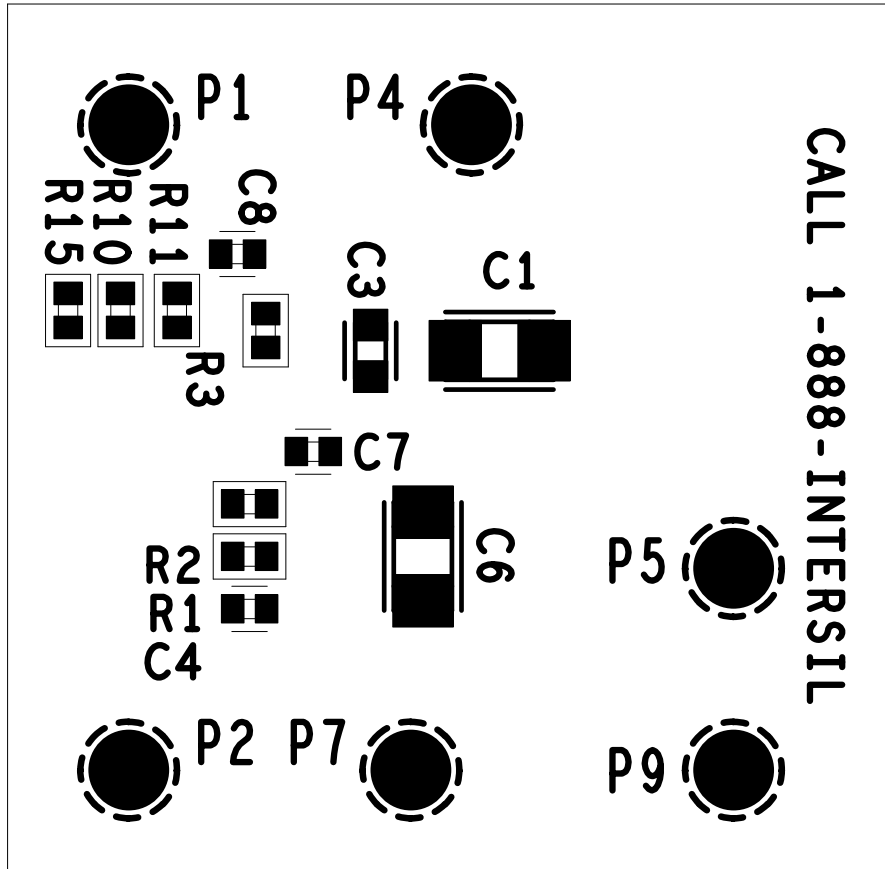

FIGURE 4. SILKSCREEN BOTTOM

Efficiency Curves $F_{SW} = 800kHz, T_A = +25^\circ C$

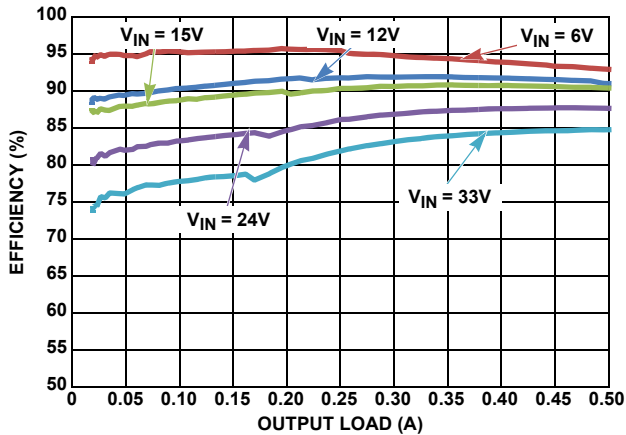

FIGURE 5. EFFICIENCY vs LOAD, PFM, $V_{OUT} = 5V$

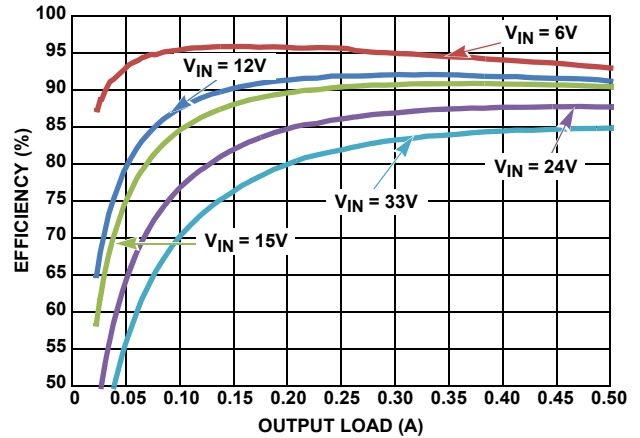

FIGURE 6. EFFICIENCY vs LOAD, PWM, $V_{OUT} = 5V$

Efficiency Curves $F_{SW} = 800kHz, T_A = +25^{\circ}C$ (Continued)

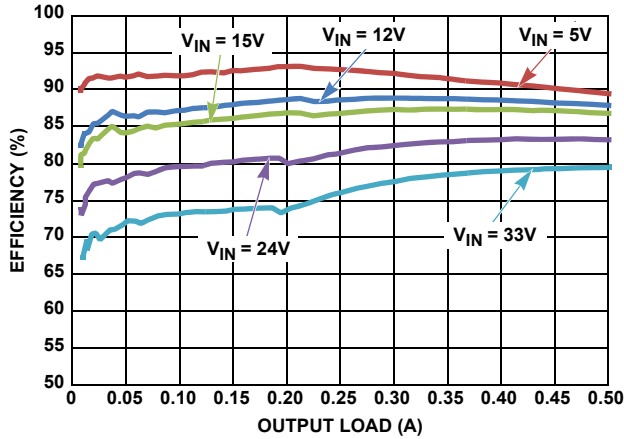

FIGURE 7. EFFICIENCY vs LOAD, PFM, $V_{OUT} = 3.3V$

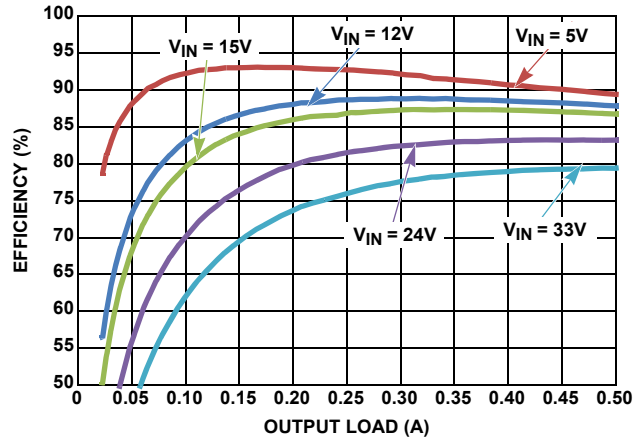

FIGURE 8. EFFICIENCY vs LOAD, PWM, $V_{OUT} = 3.3V$

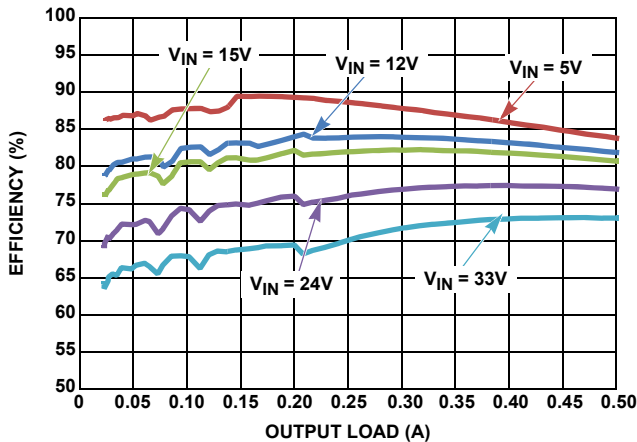

FIGURE 9. EFFICIENCY vs LOAD, PFM, $V_{OUT} = 1.8V$

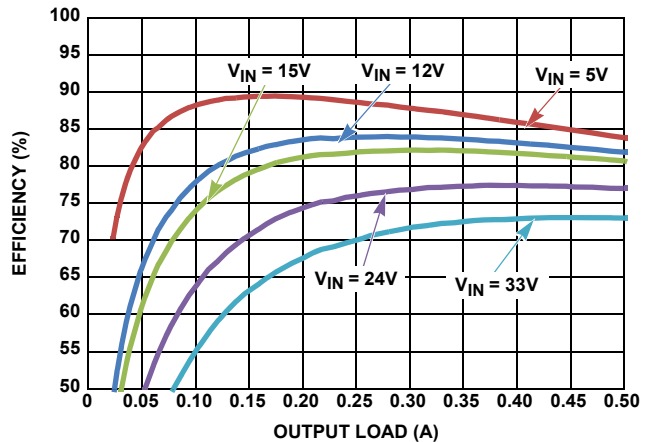

FIGURE 10. EFFICIENCY vs LOAD, PWM, $V_{OUT} = 1.8V$

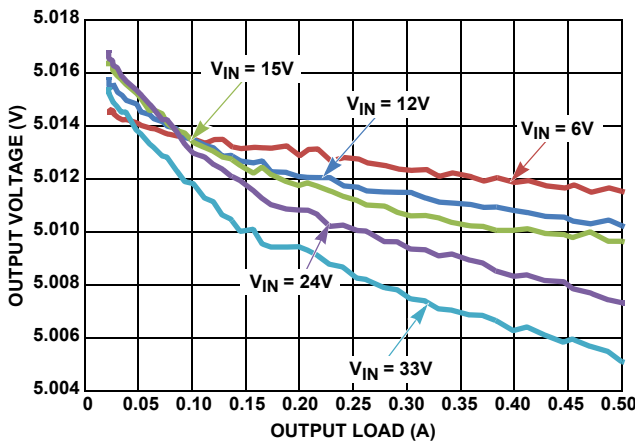

FIGURE 11. V_{OUT} REGULATION vs LOAD, PWM, $V_{OUT} = 5V$

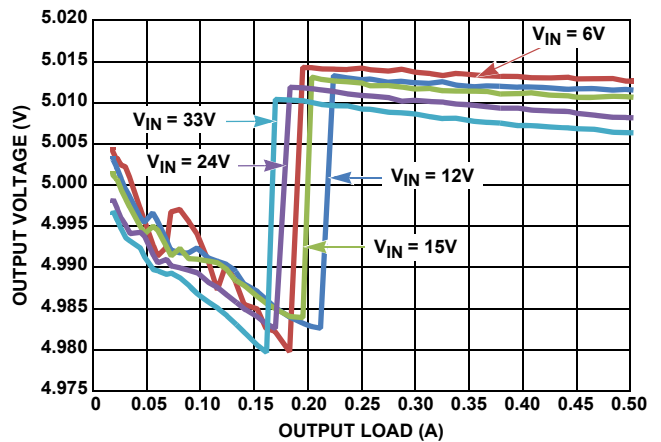

FIGURE 12. V_{OUT} REGULATION vs LOAD, PFM, $V_{OUT} = 5V$

Efficiency Curves $F_{SW} = 800kHz, T_A = +25^\circ C$ (Continued)

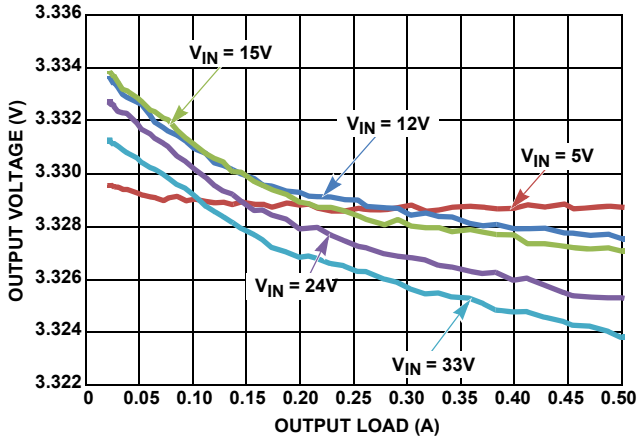

FIGURE 13. V_{OUT} REGULATION vs LOAD, PWM, $V_{OUT} = 3.3V$

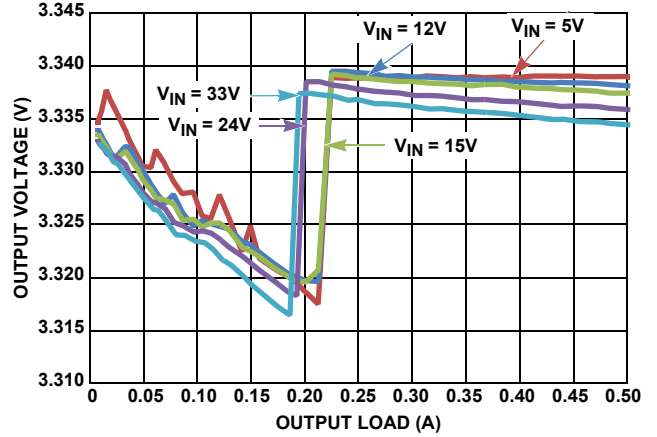

FIGURE 14. V_{OUT} REGULATION vs LOAD, PFM, $V_{OUT} = 3.3V$

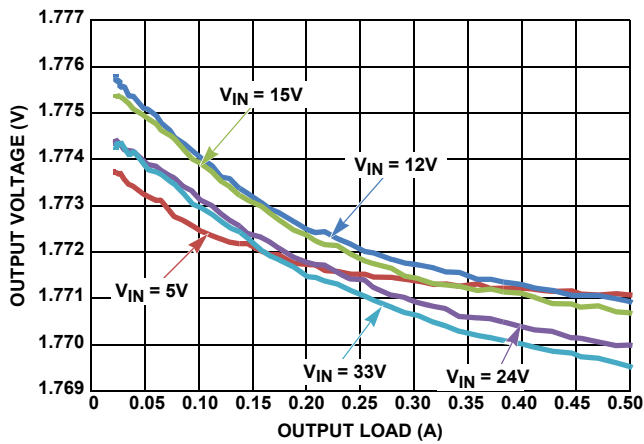

FIGURE 15. V_{OUT} REGULATION vs LOAD, PWM, $V_{OUT} = 1.8V$

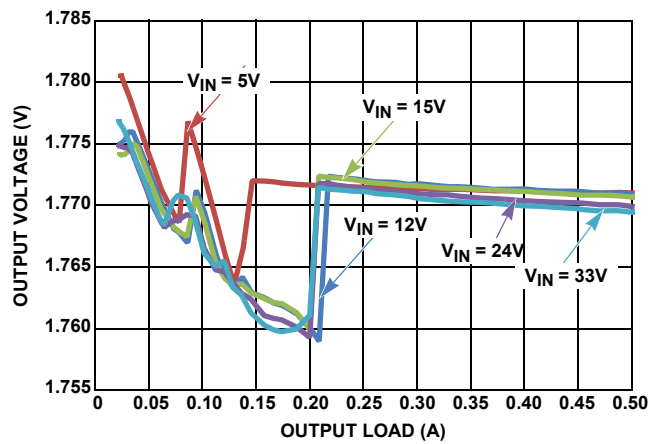

FIGURE 16. V_{OUT} REGULATION vs LOAD, PFM, $V_{OUT} = 1.8V$

Typical Performance Curves $V_{IN} = 24V, V_{OUT} = 3.3V, F_{SW} = 800kHz, T_A = +25^\circ C$

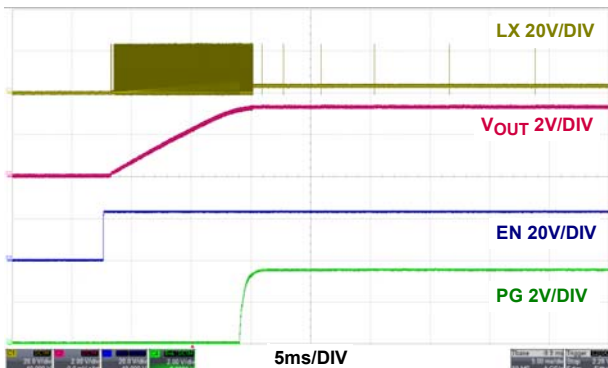

FIGURE 17. START-UP AT NO LOAD, PFM

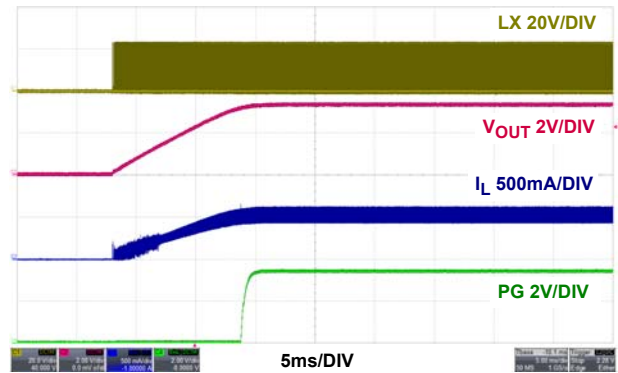

FIGURE 18. START-UP AT 500mA, PWM

Typical Performance Curves $V_{IN} = 24V, V_{OUT} = 3.3V, F_{SW} = 800kHz, T_A = +25^\circ C.$ (Continued)

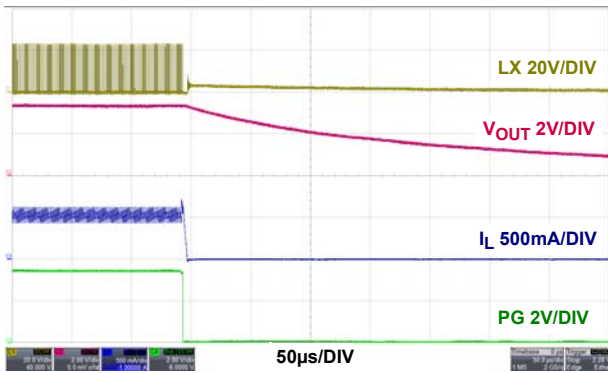

FIGURE 19. SHUTDOWN AT 500mA, PWM

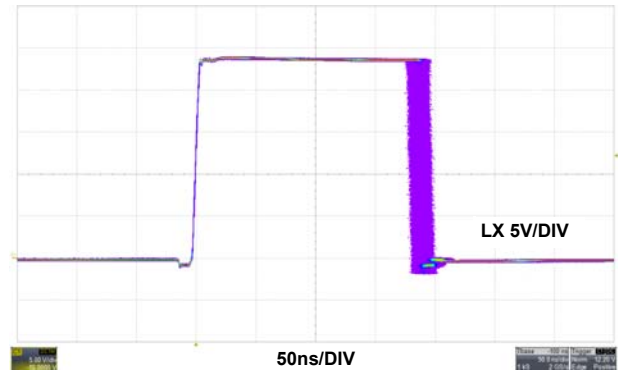

FIGURE 20. JITTER AT 500mA, PWM

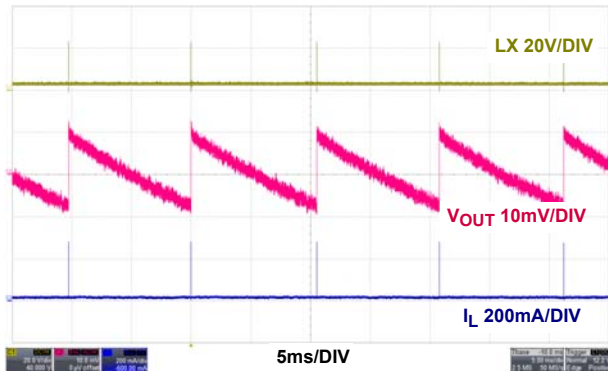

FIGURE 21. STEADY STATE AT NO LOAD, PFM

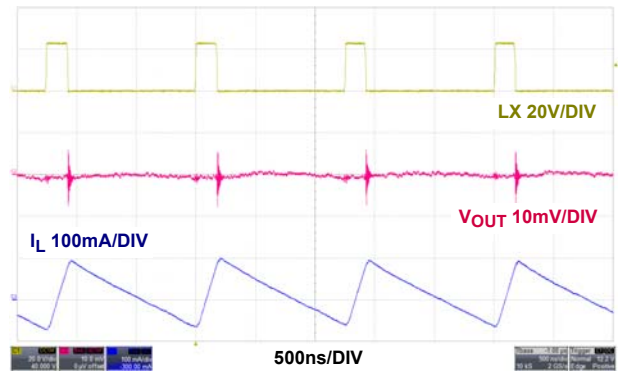

FIGURE 22. STEADY STATE AT NO LOAD, PWM

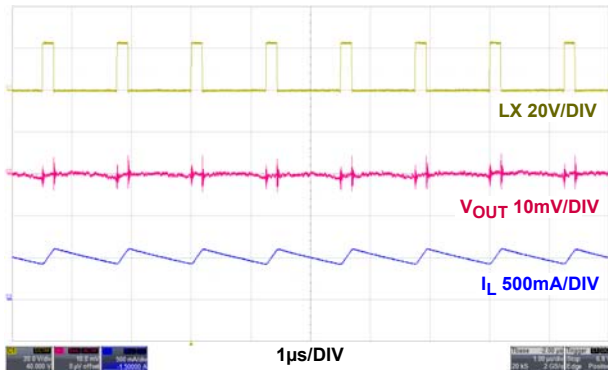

FIGURE 23. STEADY STATE AT 500mA LOAD, PWM

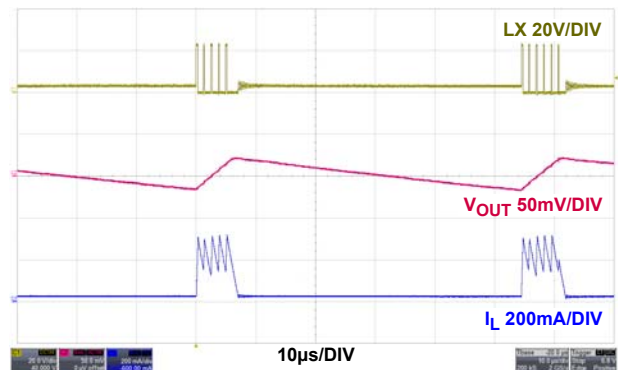

FIGURE 24. LIGHT LOAD OPERATION AT 20mA, PFM

Typical Performance Curves $V_{IN} = 24V, V_{OUT} = 3.3V, F_{SW} = 800kHz, T_A = +25^\circ C.$ (Continued)

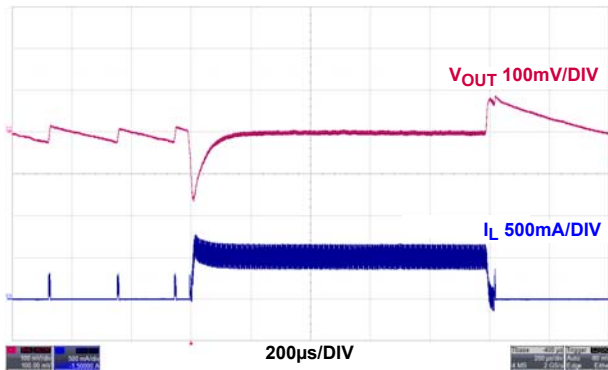

FIGURE 25. LOAD TRANSIENT, PFM

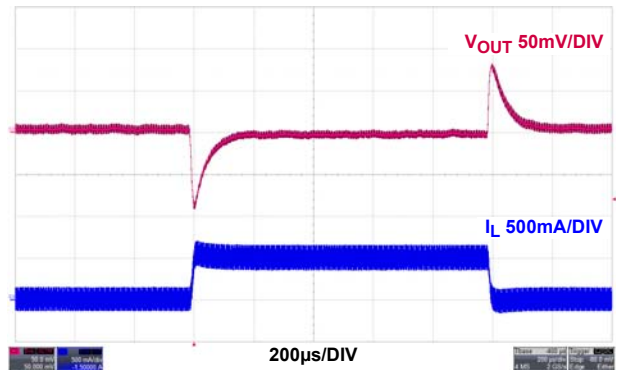

FIGURE 26. LOAD TRANSIENT, PWM

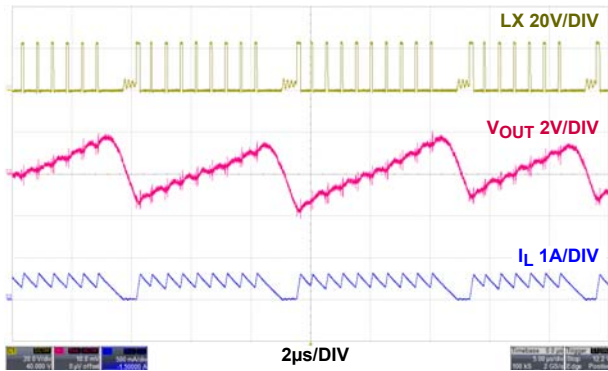

FIGURE 27. PFM TO PWM TRANSITION

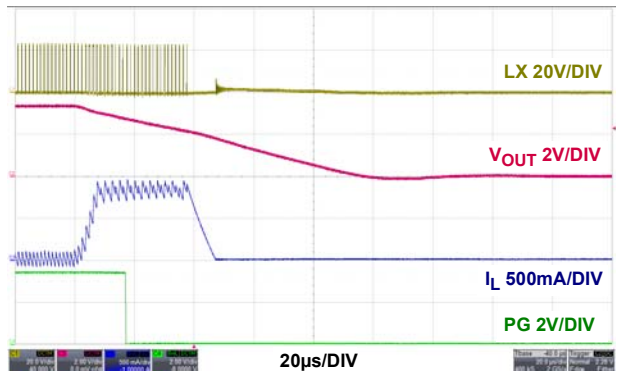

FIGURE 28. OVERCURRENT PROTECTION, PWM

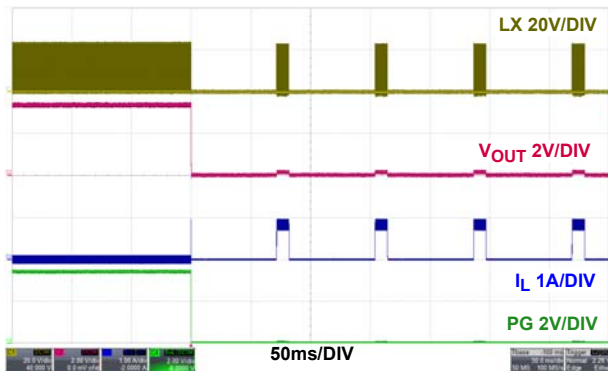

FIGURE 29. OVERCURRENT PROTECTION HICCUP, PWM

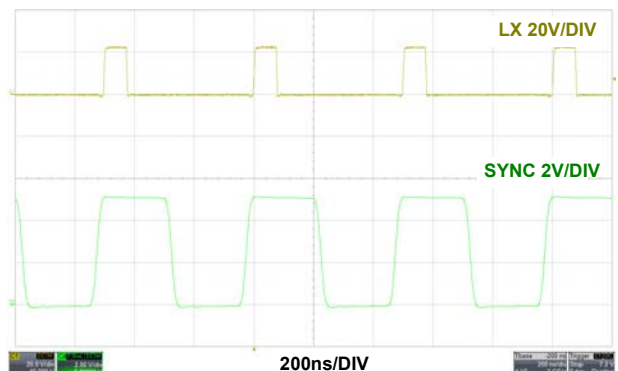

FIGURE 30. SYNC AT 500mA LOAD, PWM

Typical Performance Curves $V_{IN} = 24V, V_{OUT} = 3.3V, F_{SW} = 800kHz, T_A = +25^\circ C.$ (Continued)

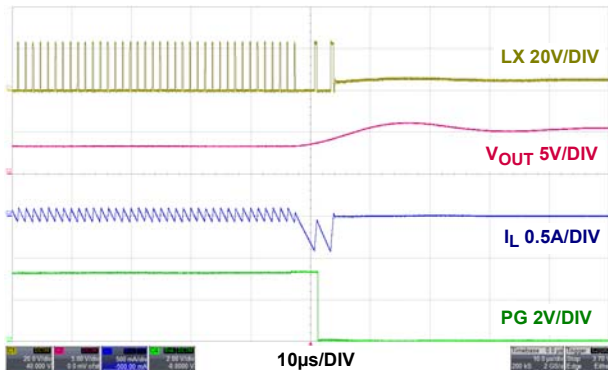

FIGURE 31. NEGATIVE CURRENT LIMIT, PWM

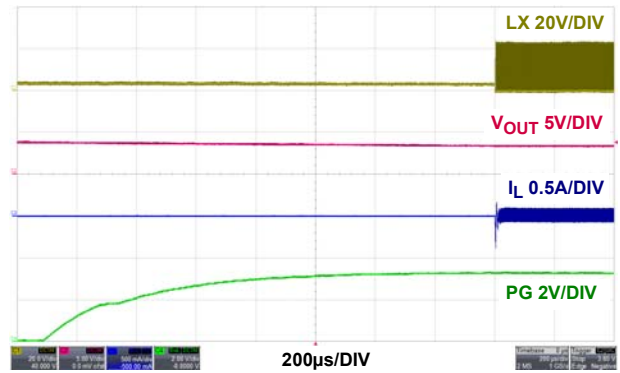

FIGURE 32. NEGATIVE CURRENT LIMIT RECOVERY, PWM

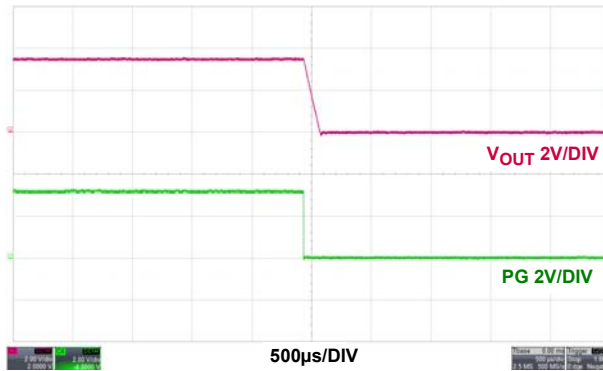

FIGURE 33. OVER-TEMPERATURE PROTECTION, PWM