

ISL9003A

Low Noise LDO with Low I<sub>Q</sub> and High PSRR

FN6299  
Rev 5.00  
July 18, 2014

ISL9003A is a high performance single low noise, high PSRR LDO that delivers a continuous 150mA of load current. It has a low standby current and is stable with 1μF of MLCC output capacitance with an ESR of up to 200mΩ.

The ISL9003A has a very high PSRR of 90dB and output noise is 20μV<sub>RMS</sub> (typical). When coupled with a no load quiescent current of 31μA (typical), and 0.5μA shutdown current, the ISL9003A is an ideal choice for portable wireless equipment.

The ISL9003A comes in many fixed voltage options with ±1.8% output voltage accuracy over temperature, line and load. Other output voltage options are available on request.

**Pinouts**

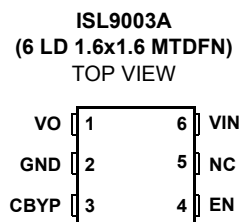
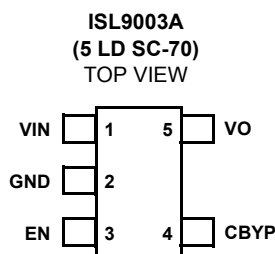

**Features**

- High Performance LDO with 150mA Continuous Output
- Excellent Transient Response to Large Current Steps
- Excellent Load Regulation:  
<0.1% voltage change across full range of load current
- Very High PSRR: >90dB at 1kHz
- Wide Input Voltage Capability: 2.3V to 6.5V
- Extremely Low Quiescent Current: 31μA
- Low Dropout Voltage: Typically 200mV at 150mA
- Low Output Noise: Typically 20μV<sub>RMS</sub> at 100μA (1.5V)
- Stable with 1μF to 4.7μF Ceramic Capacitors
- Shutdown Pin Turns Off LDO with 1μA (max) Standby Current
- Soft-start Limits Input Current Surge During Enable
- Current Limit and Overheat Protection
- ±1.8% Accuracy Over all Operating Conditions
- 5 Ld SC-70 Package or 6 Ld μTDFN Package
- -40°C to +85°C Operating Temperature Range
- Pb-Free (RoHS compliant)

**Applications**

- PDAs, Cell Phones and Smart Phones
- Portable Instruments, MP3 Players
- Handheld Devices Including Medical Handhelds

## Ordering Information

PART NUMBER ( <a href="#">Note 1</a> )	PART MARKING	V <sub>O</sub> VOLTAGE (V) ( <a href="#">Note 2</a> )	TEMP. RANGE (°C)	PACKAGE Pb-Free Tape and Reel	PKG. DWG.
ISL9003AIENZ-T ( <a href="#">Notes 3, 4</a> )	CBK	3.30	-40 to +85	5 Ld SC-70	P5.049
ISL9003AIEMZ-T ( <a href="#">Notes 3, 4</a> )	CBJ	3.00	-40 to +85	5 Ld SC-70	P5.049
ISL9003AIEKZ-T ( <a href="#">Notes 3, 4</a> )	CCE	2.85	-40 to +85	5 Ld SC-70	P5.049
ISL9003AIEJZ-T ( <a href="#">Notes 3, 4</a> )	CCD	2.80	-40 to +85	5 Ld SC-70	P5.049
ISL9003AIEHZ-T ( <a href="#">Notes 3, 4</a> )	CCC	2.75	-40 to +85	5 Ld SC-70	P5.049
ISL9003AIERZ-T ( <a href="#">Notes 3, 4</a> )	CDZ	2.60	-40 to +85	5 Ld SC-70	P5.049
ISL9003AIEFZ-T ( <a href="#">Notes 3, 4</a> )	CCB	2.50	-40 to +85	5 Ld SC-70	P5.049
ISL9003AIECZ-T ( <a href="#">Notes 3, 4</a> )	CBY	1.80	-40 to +85	5 Ld SC-70	P5.049
ISL9003AIEBZ-T ( <a href="#">Notes 3, 4</a> )	CBW	1.50	-40 to +85	5 Ld SC-70	P5.049
ISL9003AIRUBZ-T ( <a href="#">Note 5</a> )	L	1.50	-40 to +85	6 Ld $\mu$ TDFN	L6.1.6x1.6A
ISL9003AIRUCZ-T ( <a href="#">Note 5</a> )	G	1.80	-40 to +85	6 Ld $\mu$ TDFN	L6.1.6x1.6A
ISL9003AIRUFZ-T ( <a href="#">Note 5</a> )	F	2.50	-40 to +85	6 Ld $\mu$ TDFN	L6.1.6x1.6A
ISL9003AIRURZ-T ( <a href="#">Note 5</a> )	M2	2.60	-40 to +85	6 Ld $\mu$ TDFN	L6.1.6x1.6A
ISL9003AIRUHZ-T ( <a href="#">Note 5</a> )	H	2.75	-40 to +85	6 Ld $\mu$ TDFN	L6.1.6x1.6A
ISL9003AIRUJZ-T ( <a href="#">Note 5</a> )	J	2.80	-40 to +85	6 Ld $\mu$ TDFN	L6.1.6x1.6A
ISL9003AIRUKZ-T ( <a href="#">Note 5</a> )	K	2.85	-40 to +85	6 Ld $\mu$ TDFN	L6.1.6x1.6A
ISL9003AIRUMZ-T ( <a href="#">Note 5</a> )	M	3.00	-40 to +85	6 Ld $\mu$ TDFN	L6.1.6x1.6A
ISL9003AIRUNZ-T ( <a href="#">Note 5</a> )	N	3.30	-40 to +85	6 Ld $\mu$ TDFN	L6.1.6x1.6A

### NOTES:

1. Please refer to [TB347](#) for details on reel specifications.
2. For other output voltages, contact Intersil Marketing.
3. The part marking is located on the bottom of the part.
4. These Intersil Pb-free plastic packaged products employ special Pb-free material sets, molding compounds/die attach materials, and 100% matte tin plate plus anneal (e3 termination finish, which is RoHS compliant and compatible with both SnPb and Pb-free soldering operations). Intersil Pb-free products are MSL classified at Pb-free peak reflow temperatures that meet or exceed the Pb-free requirements of IPC/JEDEC J STD-020.
5. These Intersil Pb-free plastic packaged products employ special Pb-free material sets; molding compounds/die attach materials and NiPdAu plate - e4 termination finish, which is RoHS compliant and compatible with both SnPb and Pb-free soldering operations. Intersil Pb-free products are MSL classified at Pb-free peak reflow temperatures that meet or exceed the Pb-free requirements of IPC/JEDEC J STD-020.

**Absolute Maximum Ratings**

Supply Voltage ( $V_{IN}$ )	+7.1V
$V_O$ Pin	+3.6V
All Other Pins	-0.3V to ( $V_{IN} + 0.3V$ )

**Recommended Operating Conditions**

Ambient Temperature Range ( $T_A$ )	-40°C to +85°C
Supply Voltage ( $V_{IN}$ )	2.3V to 6.5V

**Thermal Information**

Thermal Resistance	$\theta_{JA}$ (°C/W)
5 Ld SC-70 Package (Note 6)	231
6 Ld $\mu$ TDFN Package (Note 7)	125
Junction Temperature Range	-40°C to +125°C
Operating Temperature Range	-40°C to +85°C
Storage Temperature Range	-65°C to +150°C
Pb-free Reflow Profile	see <a href="#">TB493</a>

**CAUTION:** Do not operate at or near the maximum ratings listed for extended periods of time. Exposure to such conditions may adversely impact product reliability and result in failures not covered by warranty.

**NOTES:**

- $\theta_{JA}$  is measured with the component mounted on a high effective thermal conductivity test board in free air. See Tech Brief [TB379](#) for details.
- $\theta_{JA}$  is measured in free air with the component mounted on a high effective thermal conductivity test board with "direct attach" features. See Tech Brief [TB379](#).

**Electrical Specifications** Unless otherwise noted, all parameters are guaranteed over the operational supply voltage and temperature range of the device as follows:  $T_A = -40^\circ\text{C}$  to  $+85^\circ\text{C}$ ;  $V_{IN} = (V_O + 0.5V)$  to 6.5V with a minimum  $V_{IN}$  of 2.3V;  $C_{IN} = 1\mu\text{F}$ ;  $C_O = 1\mu\text{F}$ ;  $C_{BYP} = 0.01\mu\text{F}$ .

PARAMETER	SYMBOL	TEST CONDITIONS	MIN (Note 10)	TYP	MAX (Note 10)	UNITS			
<b>DC CHARACTERISTICS</b>									
Supply Voltage	$V_{IN}$		2.3		6.5	V			
Ground Current	$I_{DD}$	Output Enabled; $I_O = 0\mu\text{A}$ ; $V_{IN} < 4.2V$		31	40	$\mu\text{A}$			
		Output Enabled; $I_O = 0\mu\text{A}$ ; Full voltage range			57	$\mu\text{A}$			
Shutdown Current	$I_{DDS}$			0.5	1.2	$\mu\text{A}$			
UVLO Threshold	$V_{UV+}$		1.9	2.1	2.3	V			
	$V_{UV-}$		1.6	1.8	2.0	V			
Regulation Voltage Accuracy		Initial accuracy at $V_{IN} = V_O + 0.5V$ , $I_O = 10\text{mA}$ , $T_J = +25^\circ\text{C}$	-0.7		+0.7	%			
		$V_{IN} = V_O + 0.5V$ to 6.5V, $I_O = 10\mu\text{A}$ to 150mA, $T_J = +25^\circ\text{C}$	-0.8		+0.8	%			
		$V_{IN} = V_O + 0.5V$ to 6.5V, $I_O = 10\mu\text{A}$ to 150mA, $T_J = -40^\circ\text{C}$ to $+125^\circ\text{C}$	-1.8		+1.8	%			
Maximum Output Current	$I_{MAX}$	Continuous	150			mA			
Internal Current Limit	$I_{LIM}$		175	265	355	mA			
Drop-out Voltage (Note 9)	$V_{DO1}$	$I_O = 150\text{mA}$ ; $V_O < 2.5V$		300	500	mV			
	$V_{DO2}$	$I_O = 150\text{mA}$ ; $2.5V \leq V_O \leq 2.8V$		250	400	mV			
	$V_{DO3}$	$I_O = 150\text{mA}$ ; $2.8V < V_O$		200	325	mV			
Thermal Shutdown Temperature	$T_{SD+}$			140		$^\circ\text{C}$			
	$T_{SD-}$			110		$^\circ\text{C}$			
<b>AC CHARACTERISTICS</b>									
Ripple Rejection (Note 8)		$I_O = 10\text{mA}$ , $V_{IN} = 2.8V(\text{min})$ , $V_O = 1.8V$ , $C_{BYP} = 0.1\mu\text{F}$				at 1kHz	90		dB
						at 10kHz	70		dB
						at 100kHz	50		dB
Output Noise Voltage (Note 8)		$V_O = 1.5V$ , $T_A = +25^\circ\text{C}$ , $C_{BYP} = 0.1\mu\text{F}$				BW = 10Hz to 100kHz, $I_O = 100\mu\text{A}$	20		$\mu\text{V}_{RMS}$
						BW = 10Hz to 100kHz, $I_O = 10\text{mA}$	30		$\mu\text{V}_{RMS}$

**Electrical Specifications** Unless otherwise noted, all parameters are guaranteed over the operational supply voltage and temperature range of the device as follows:  $T_A = -40^{\circ}\text{C}$  to  $+85^{\circ}\text{C}$ ;  $V_{IN} = (V_O + 0.5\text{V})$  to  $6.5\text{V}$  with a minimum  $V_{IN}$  of  $2.3\text{V}$ ;  $C_{IN} = 1\mu\text{F}$ ;  $C_O = 1\mu\text{F}$ ;  $C_{BYP} = 0.01\mu\text{F}$ . **(Continued)**

PARAMETER	SYMBOL	TEST CONDITIONS	MIN (Note 10)	TYP	MAX (Note 10)	UNITS
<b>DEVICE START-UP CHARACTERISTICS</b>						
Device Enable time	$t_{EN}$	Time from assertion of the EN pin to when the output voltage reaches 95% of the $V_O(\text{nom})$ .		250	500	$\mu\text{s}$
LDO Soft-start Ramp Rate	$t_{SSR}$	Slope of linear portion of LDO output voltage ramp during start-up		30	60	$\mu\text{s}/\text{V}$
<b>EN PIN CHARACTERISTICS</b>						
Input Low Voltage	$V_{IL}$		-0.3		0.4	V
Input High Voltage	$V_{IH}$		1.4		$V_{IN} + 0.3$	V
Input Leakage Current	$I_{IL}, I_{IH}$				0.1	$\mu\text{A}$
Pin Capacitance	$C_{PIN}$	Informative		5		pF

NOTES:

- Limits established by characterization and are not production tested.
- $V_O = 0.98 \cdot V_O(\text{NOM})$ ; Valid for  $V_O$  greater than  $1.85\text{V}$ .
- Parameters with MIN and/or MAX limits are 100% tested at  $+25^{\circ}\text{C}$ , unless otherwise specified. Temperature limits established by characterization and are not production tested.

**Typical Performance Curves**

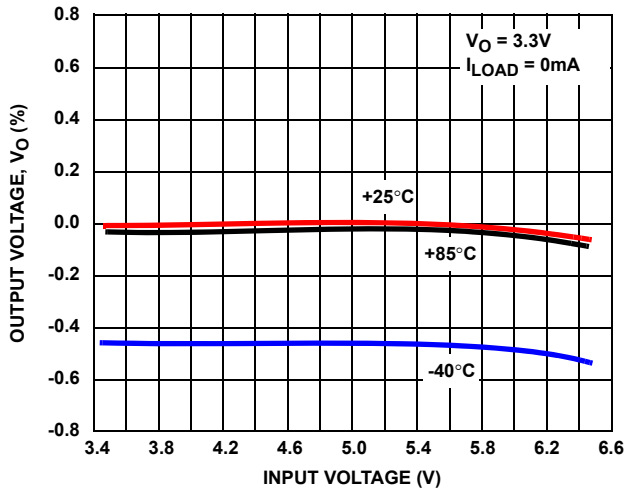

FIGURE 1. OUTPUT VOLTAGE vs INPUT VOLTAGE (3.3V OUTPUT)

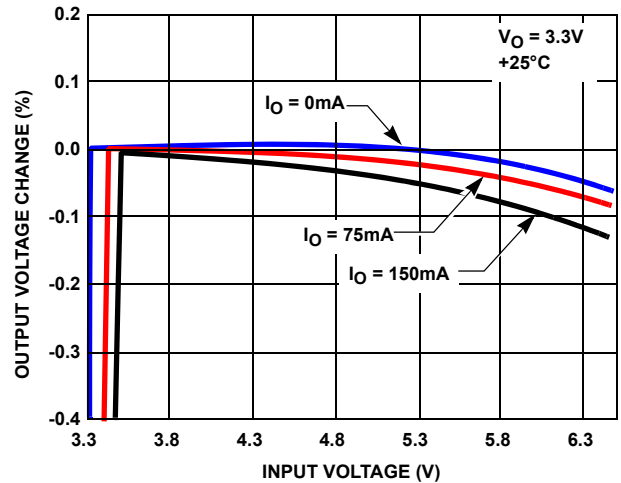

FIGURE 2. OUTPUT VOLTAGE CHANGE (%) vs INPUT VOLTAGE (3.3V OUTPUT)

Typical Performance Curves (Continued)

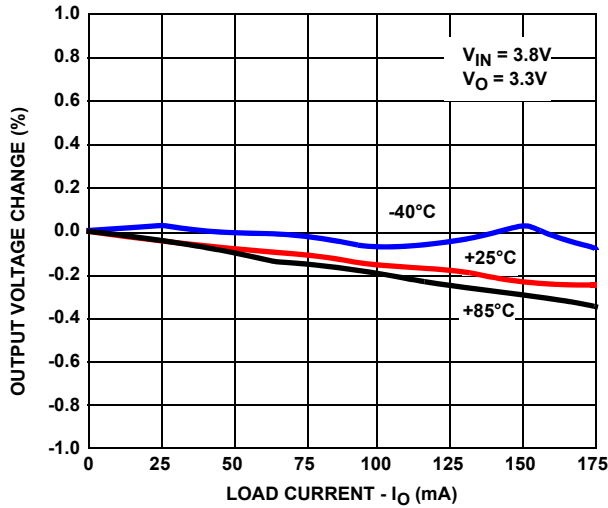

FIGURE 3. OUTPUT VOLTAGE vs LOAD CURRENT

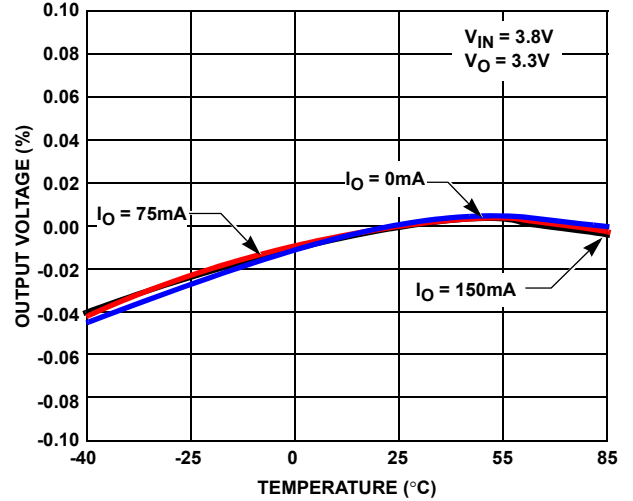

FIGURE 4. OUTPUT VOLTAGE vs TEMPERATURE

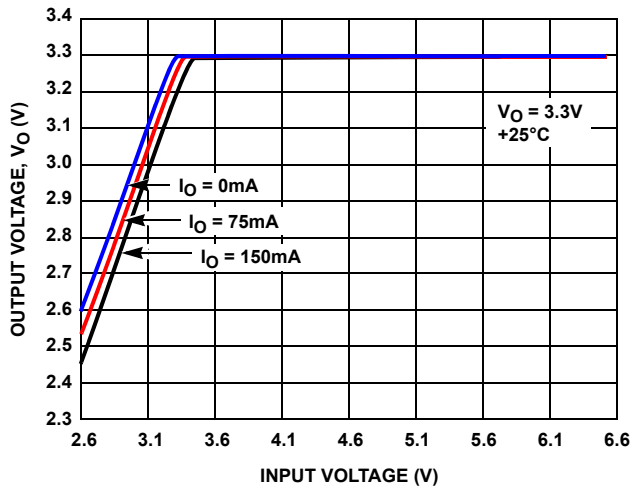

FIGURE 5. DROPOUT VOLTAGE vs INPUT VOLTAGE (3.3V OUTPUT)

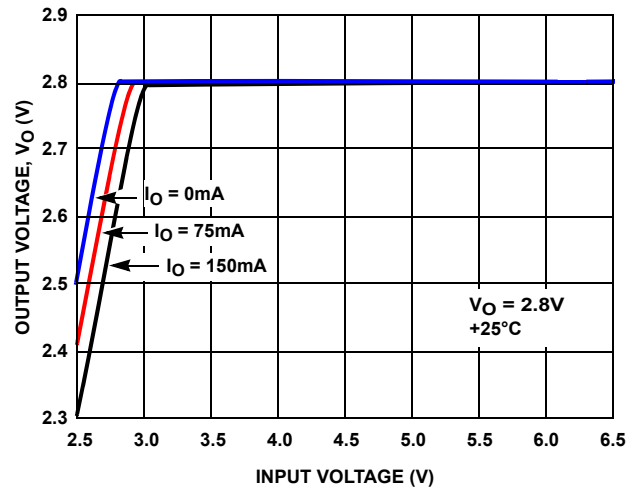

FIGURE 6. DROPOUT VOLTAGE vs INPUT VOLTAGE (2.8V OUTPUT)

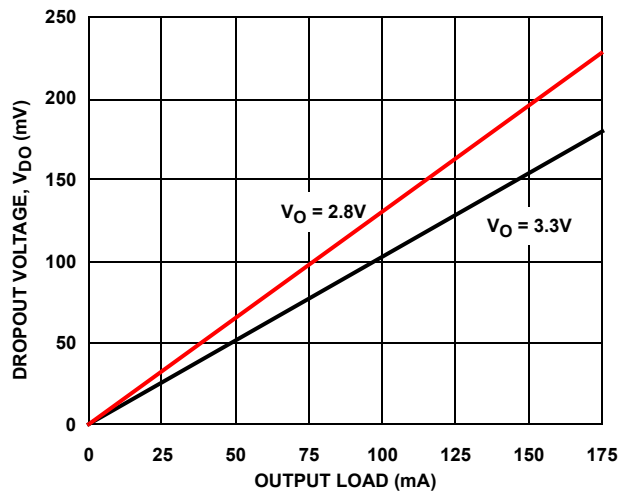

FIGURE 7. DROPOUT VOLTAGE vs LOAD CURRENT

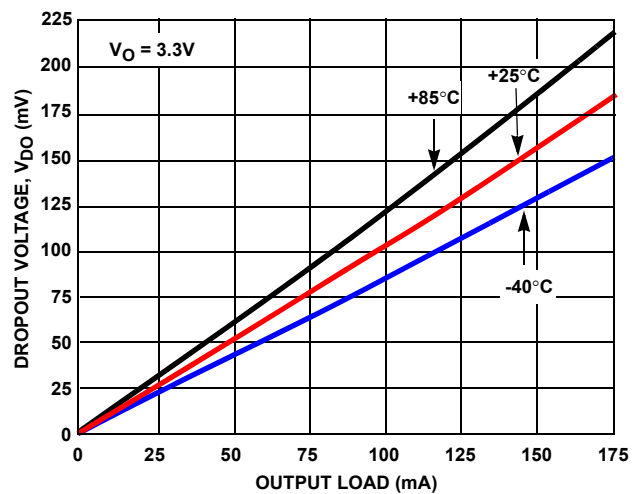

FIGURE 8. DROPOUT VOLTAGE vs LOAD CURRENT

Typical Performance Curves (Continued)

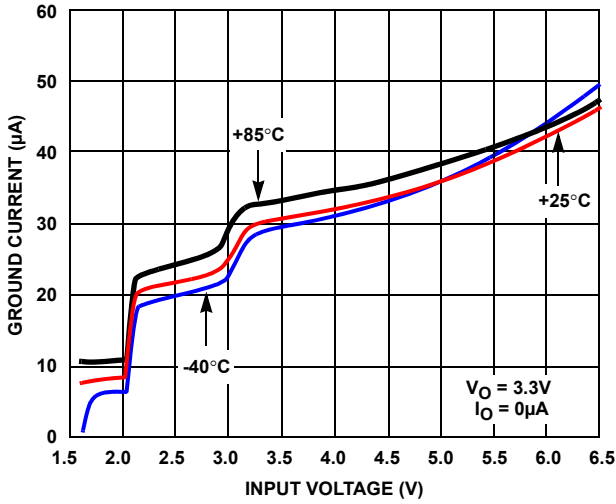

FIGURE 9. GROUND CURRENT vs INPUT VOLTAGE

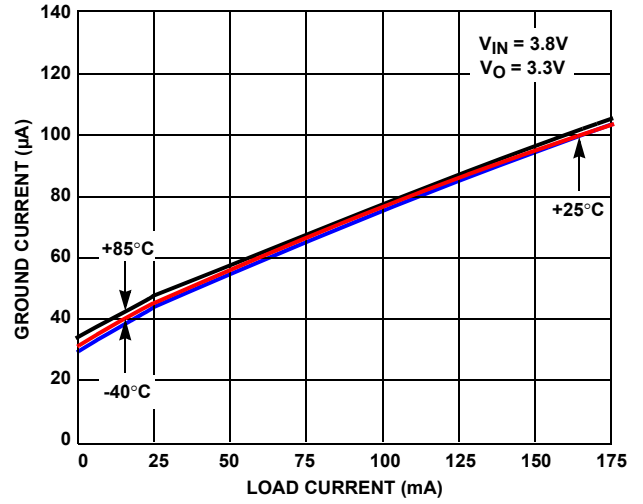

FIGURE 10. GROUND CURRENT vs LOAD

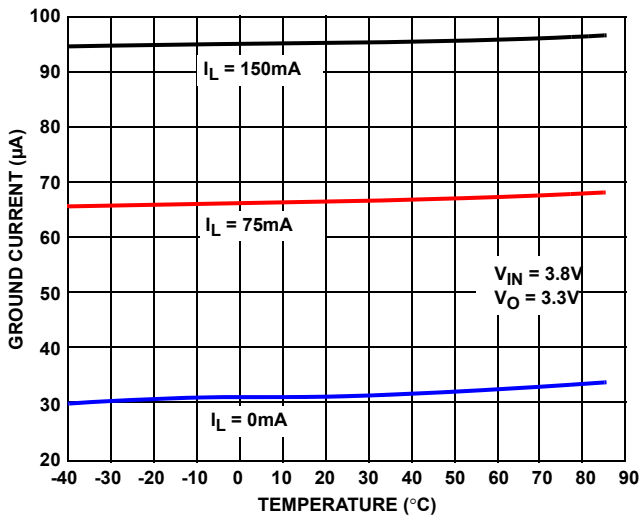

FIGURE 11. GROUND CURRENT vs TEMPERATURE

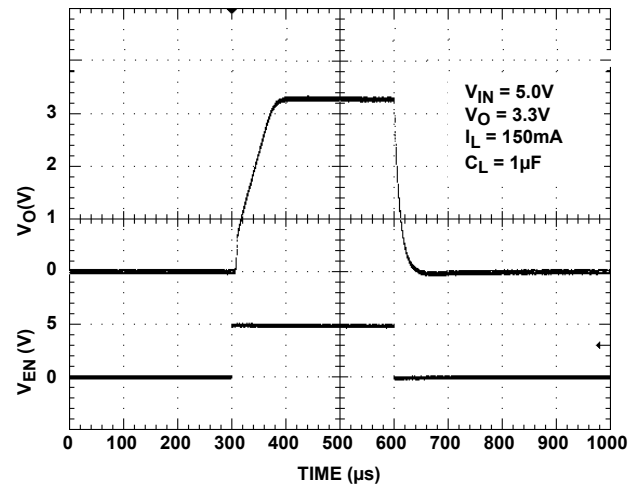

FIGURE 12. TURN ON/TURN OFF RESPONSE

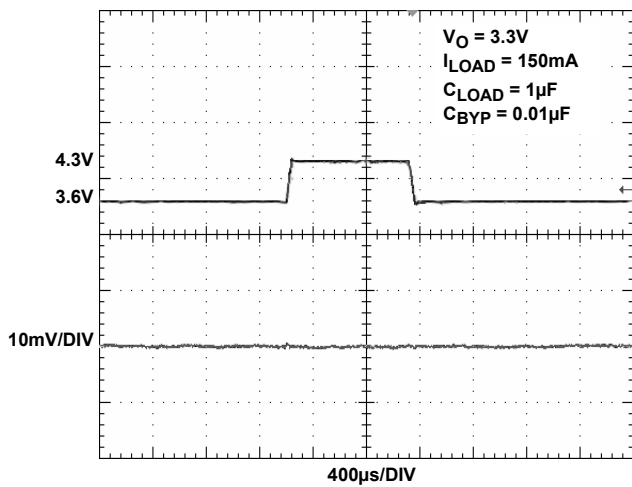

FIGURE 13. LINE TRANSIENT RESPONSE, 3.3V OUTPUT

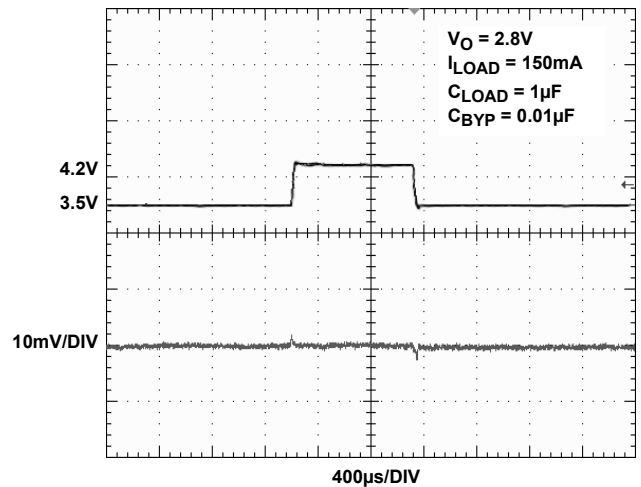

FIGURE 14. LINE TRANSIENT RESPONSE, 2.8V OUTPUT

Typical Performance Curves (Continued)

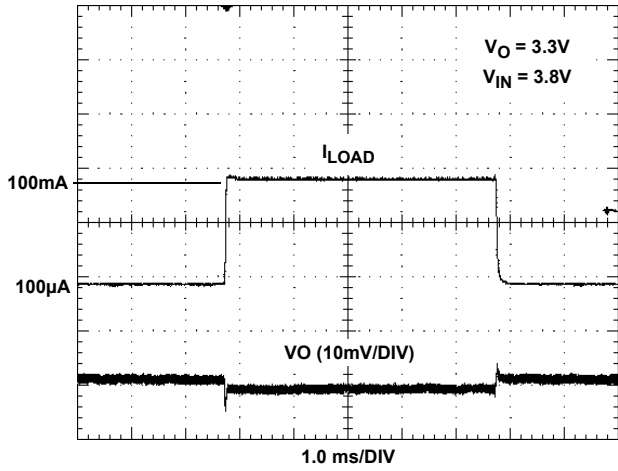

FIGURE 15. LOAD TRANSIENT RESPONSE

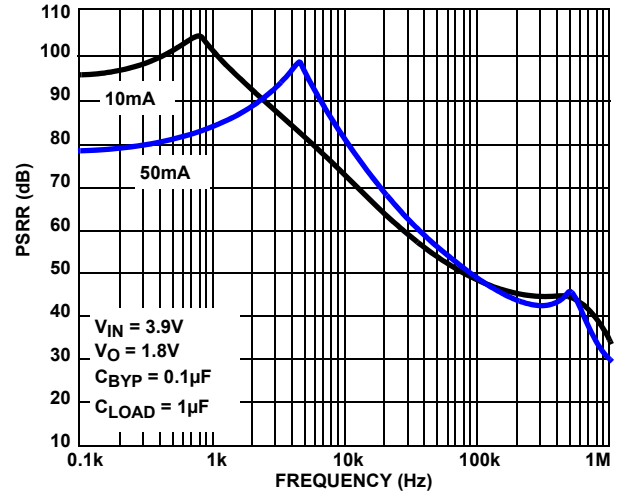

FIGURE 16. PSRR vs FREQUENCY

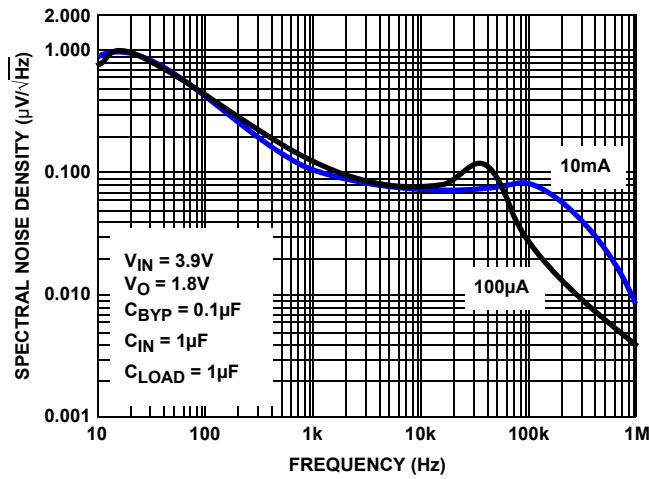
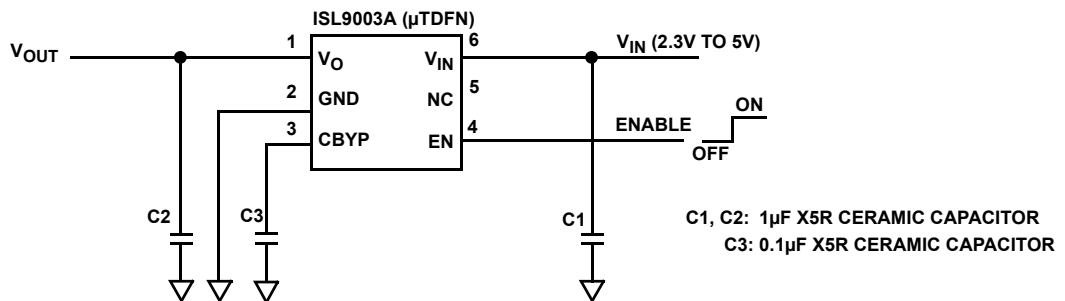
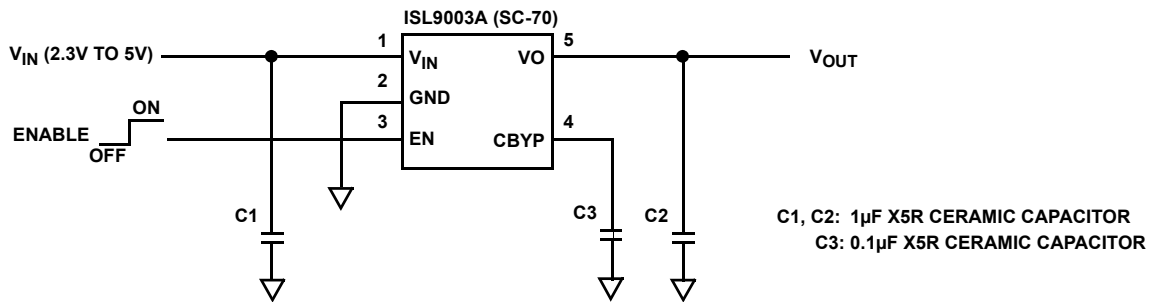

FIGURE 17. SPECTRAL NOISE DENSITY vs FREQUENCY

**Pin Description**

5 LD SC-70 PIN NUMBER	6 LD $\mu$ TDFN PIN NUMBER	PIN NAME	DESCRIPTION
1	6	V <sub>IN</sub>	Supply Voltage/LDO Input. Connect a 1 $\mu$ F capacitor to GND.
2	2	GND	GND is the connection to system ground. Connect to PCB Ground plane.
3	4	EN	Output Enable. When this signal goes high, the LDO is turned on.
4	3	CBYP	Reference Bypass Capacitor Pin. Optionally connect capacitor of value 0.01 $\mu$ F to 1 $\mu$ F between this pin and GND to tune in the desired noise and PSRR performance.
5	1	V <sub>O</sub>	LDO Output. Connect a 1 $\mu$ F capacitor of value to GND.
-	5	NC	No Connect.

**Typical Application**





## Block Diagram

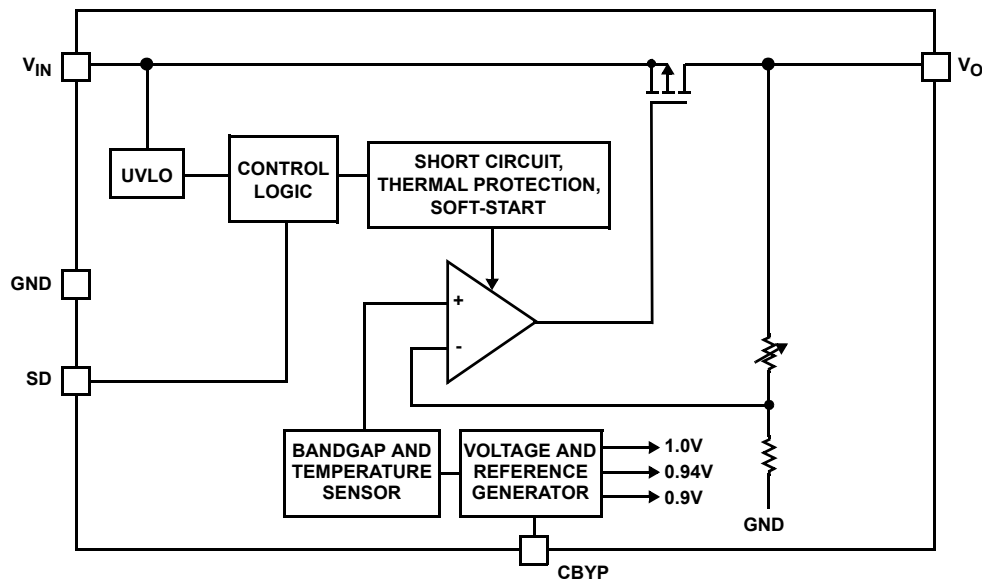

### Functional Description

The ISL9003A contains all circuitry required to implement a high performance LDO. High performance is achieved through a circuit that delivers fast transient response to varying load conditions. In a quiescent condition, the ISL9003A adjusts its biasing to achieve the lowest standby current consumption.

The device also integrates current limit protection, smart thermal shutdown protection, and soft-start. Smart Thermal shutdown protects the device against overheating. Soft-start minimizes start-up input current surges without causing excessive device turn-on time.

### Power Control

The ISL9003A has an enable pin, (EN), to control power to the LDO output. When EN is low, the device is in shutdown mode. In this condition, all on-chip circuits are off, and the device draws minimum current, typically less than  $0.3\mu\text{A}$ . When the EN pin goes high, the device first polls the output of the UVLO detector to ensure that VIN voltage is at least 2.1V (typical). Once verified, the device initiates a start-up sequence. During the start-up sequence, trim settings are first read and latched. Then, sequentially, the bandgap, reference voltage and current generation circuitry turn-on. Once the references are stable, the LDO powers-up.

During operation, whenever the VIN voltage drops below about 1.84V, the ISL9003A immediately disables the LDO output. When VIN rises back above 2.1V (assuming the EN pin is high), the device re-initiates its start-up sequence and LDO operation resumes automatically.

### Reference Generation

The reference generation circuitry includes a trimmed bandgap, a trimmed voltage reference divider, a trimmed

current reference generator, and an RC noise filter. The filter includes the external capacitor connected to the CBYP pin. A  $0.01\mu\text{F}$  capacitor connected CBYP implements a 100Hz lowpass filter, and is recommended for most high performance applications. For the lowest noise application, a  $0.1\mu\text{F}$  or greater CBYP capacitor should be used. This filters the reference noise to below the 10Hz to 1kHz frequency band, which is crucial in many noise-sensitive applications.

The bandgap generates a zero temperature coefficient (TC) voltage for the regulator reference and other voltage references required for current generation and over-temperature detection.

A current generator provides references required for adaptive biasing as well as references for LDO output current limit and thermal shutdown determination.

### LDO Regulation and Programmable Output Divider

The LDO Regulator is implemented with a high-gain operational amplifier driving a PMOS pass transistor. The design of the ISL9003A provides a regulator that has low quiescent current, fast transient response, and overall stability across all operating and load current conditions. LDO stability is guaranteed for a  $1\mu\text{F}$  to  $4.7\mu\text{F}$  output capacitor that has a tolerance better than 20% and ESR less than  $200\text{m}\Omega$ . The design is performance-optimized for a  $1\mu\text{F}$  capacitor. Unless limited by the application, use of an output capacitor value above  $4.7\mu\text{F}$  is not recommended as LDO performance improvement is minimal. Soft-start circuitry integrated into each LDO limits the initial ramp-up rate to about  $30\mu\text{s}/\text{V}$  to minimize current surge. The ISL9003A provides short-circuit protection by limiting the output current to about 265mA (typ).

The LDO uses an independently trimmed 1V reference as its input. An internal resistor divider drops the LDO output voltage down to 1V. This is compared to the 1V reference for regulation. The resistor division ratio is programmed in the factory.

### **Overheat Detection**

The bandgap outputs a proportional-to-temperature current that is indicative of the temperature of the silicon. This current is compared with references to determine if the device is in danger of damage due to overheating. When the die temperature reaches about +140 °C, the LDO momentarily shuts down until the die cools sufficiently. In the overheat condition, if the LDO sources more than 50mA it will be shut off. Once the die temperature falls back below about +110 °C, the disabled LDO is re-enabled and soft-start automatically takes place.

### **Exposed Thermal Pad**

The ISL9003A with  $\mu$ TDFN package has an exposed thermal pad at the bottom side of the package. The PCB layout should connect the exposed pad to some copper on the component layer for a good thermal conductivity. Since the copper area on the component layer is limited by the surrounding pins of the package, it is more effective to use some thermal vias to conduct the heat to other copper layers if possible.

Electrically the copper and vias connecting to the exposed pad should be isolated from any other pin connection, they are strictly for thermal enhancement purpose.

© Copyright Intersil Americas LLC 2006-2014. All Rights Reserved.  
All trademarks and registered trademarks are the property of their respective owners.

For additional products, see [www.intersil.com/en/products.html](http://www.intersil.com/en/products.html)

Intersil products are manufactured, assembled and tested utilizing ISO9001 quality systems as noted in the quality certifications found at [www.intersil.com/en/support/qualandreliability.html](http://www.intersil.com/en/support/qualandreliability.html)

*Intersil products are sold by description only. Intersil may modify the circuit design and/or specifications of products at any time without notice, provided that such modification does not, in Intersil's sole judgment, affect the form, fit or function of the product. Accordingly, the reader is cautioned to verify that datasheets are current before placing orders. Information furnished by Intersil is believed to be accurate and reliable. However, no responsibility is assumed by Intersil or its subsidiaries for its use; nor for any infringements of patents or other rights of third parties which may result from its use. No license is granted by implication or otherwise under any patent or patent rights of Intersil or its subsidiaries.*

For information regarding Intersil Corporation and its products, see [www.intersil.com](http://www.intersil.com)

**Small Outline Transistor Plastic Packages (SC70-5)**

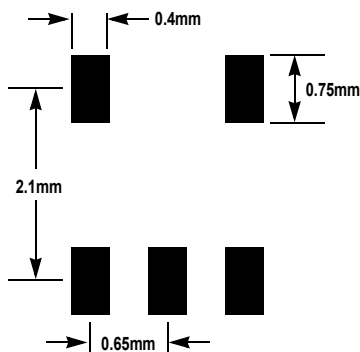
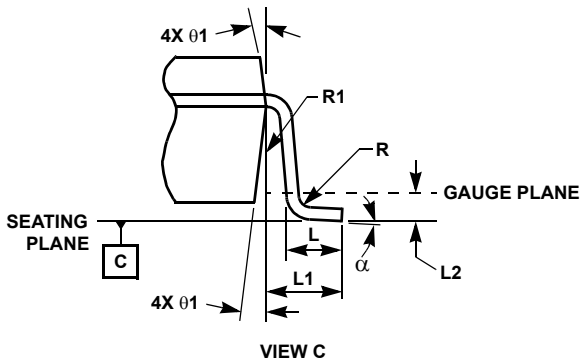
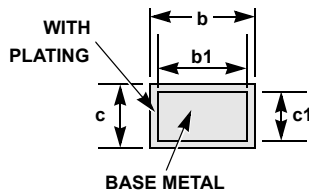
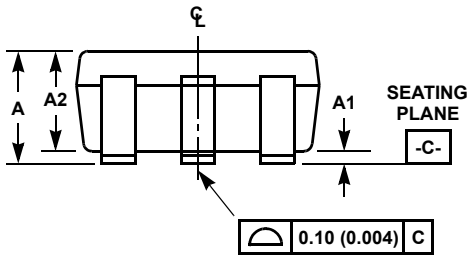
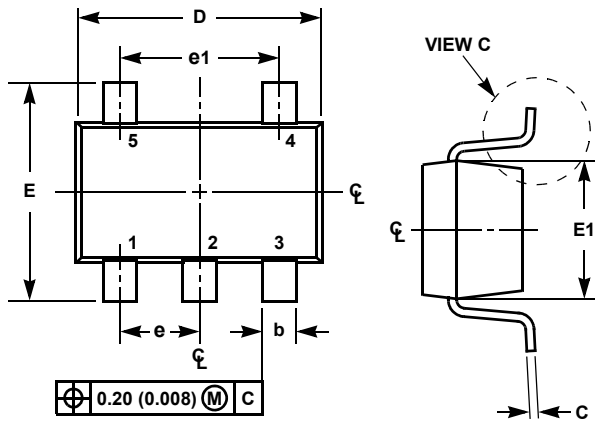

TYPICAL RECOMMENDED LAND PATTERN

**P5.049**

**5 LEAD SMALL OUTLINE TRANSISTOR PLASTIC PACKAGE**

SYMBOL	INCHES		MILLIMETERS		NOTES
	MIN	MAX	MIN	MAX	
A	0.031	0.043	0.80	1.10	-
A1	0.000	0.004	0.00	0.10	-
A2	0.031	0.039	0.80	1.00	-
b	0.006	0.012	0.15	0.30	-
b1	0.006	0.010	0.15	0.25	-
c	0.003	0.009	0.08	0.22	6
c1	0.003	0.009	0.08	0.20	6
D	0.073	0.085	1.85	2.15	3
E	0.071	0.094	1.80	2.40	-
E1	0.045	0.053	1.15	1.35	3
e	0.0256 Ref		0.65 Ref		-
e1	0.0512 Ref		1.30 Ref		-
L	0.010	0.018	0.26	0.46	4
L1	0.017 Ref.		0.420 Ref.		-
L2	0.006 BSC		0.15 BSC		-
α	0°	8°	0°	8°	-
N	5		5		5
R	0.004	-	0.10	-	-
R1	0.004	0.010	0.15	0.25	-

Rev. 3 7/07

**NOTES:**

1. Dimensioning and tolerances per ASME Y14.5M-1994.
2. Package conforms to EIAJ SC70 and JEDEC MO-203AA.
3. Dimensions D and E1 are exclusive of mold flash, protrusions, or gate burrs.
4. Footlength L measured at reference to gauge plane.
5. "N" is the number of terminal positions.
6. These Dimensions apply to the flat section of the lead between 0.08mm and 0.15mm from the lead tip.
7. Controlling dimension: MILLIMETER. Converted inch dimensions are for reference only.