

ISL9016A

150mA Dual LDO with Low Noise, High PSRR and Low I_Q

FN8865
Rev 0.00
August 3, 2016

The [ISL9016A](#) is a high performance dual LDO capable of providing up to 150mA current on each channel. It features a low standby current and very high PSRR and is stable with output capacitance of 1μF to 4.7μF with an ESR of up to 200mΩ.

The device integrates a separate enable function for each output. The quiescent current is typically 49μA when only one LDO is enabled and typically 80μA when both LDOs are enabled. When both LDOs are under shutdown condition, the drawing current is typically less than 1μA.

The ISL9016A provides a wide input voltage range from 1.8V to 6.5V. It also has a high PSRR of 80dB at 1kHz and 45dB at 1MHz. The ISL9016A also provides output current limit, overheat protection, reverse current protection, as well as excellent load transient response.

The ISL9016A is offered in a tiny 1.6mmx1.6mm 6 Ld UTDFN package. Output voltage options are available from 1.2V to 2.8V. Several combinations of voltage outputs are standard and others may be available upon request.

Features

- Dual integrated 150mA high performance LDOs
- High PSRR: 80dB at 1kHz and 45dB at 1MHz
- Reverse current protection
- Low quiescent current
 - 49μA (single LDO enabled)/80μA (dual LDOs enabled)
- Excellent load transient response
- Typically ±0.8% output voltage accuracy
- Low output noise: typically 25μV_{RMS}
- Wide input voltage capability: 1.8V to 6.5V
- Low dropout voltage: typically 120mV at 150mA
- Separate enable control for each LDO
- Stable with 1μF to 4.7μF ceramic output capacitors
- Soft-start to limit input current surge during enable
- Current limit and overheat protection
- Tiny 6 Ld 1.6mmx1.6mm UTDFN package
- Pb-free (RoHS Compliant)

Applications

- PDAs, cell phones and smart phones
- Portable instruments, MP3/4 players, PMP, DSC
- Handheld devices including medical handhelds

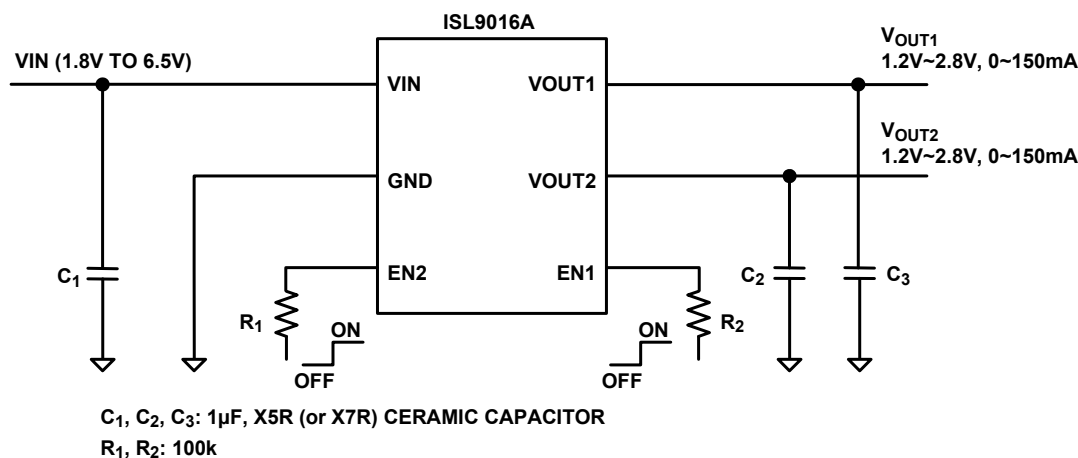
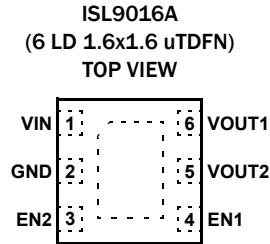

FIGURE 1. TYPICAL APPLICATION DIAGRAM

Pin Configuration



Pin Descriptions

PIN #	PIN NAME	DESCRIPTION
1	VIN	Supply Voltage/LDO input. Connect a 1 μ F capacitor to GND.
2	GND	GND is the connection to system ground. Connect to PCB ground plane.
3	EN2	LDO2 Enable pin. Enable = High, Disable = Low. A 100k resistor should be connected between EN2 and the control voltage rail. Do NOT leave it floating.
4	EN1	LDO1 Enable pin. Enable = High, Disable = Low. A 100k resistor should be connected between EN1 and the control voltage rail. Do NOT leave it floating.
5	VOUT2	LDO2 Output. Connect capacitor with a value from 1 μ F to 4.7 μ F to GND (1 μ F recommended).
6	VOUT1	LDO1 Output. Connect capacitor with a value from 1 μ F to 4.7 μ F to GND (1 μ F recommended).
-	E-Pad	Connect the e-pad to the system ground.

Ordering Information

PART NUMBER (Notes 1, 3)	PART MARKING	V _{OUT1} VOLTAGE (V) (Note 2)	V _{OUT2} VOLTAGE (V) (Note 2)	TEMP RANGE (°C)	TAPE AND REEL (UNITS)	PACKAGE (RoHS COMPLIANT)	PKG DWG. #
ISL9016AIRUWJZ-T	W2	1.2	2.8	-40 to +85	3k	6 Ld UTDFN	L6.1.6x1.6A
ISL9016AIRUJCZ-T	W1	2.8	1.8	-40 to +85	3k	6 Ld UTDFN	L6.1.6x1.6A
ISL9016AIRUNCZ-T	W3	3.3	1.8	-40 to +85	3k	6 Ld UTDFN	L6.1.6x1.6A

NOTES:

1. Please refer to [TB347](#) for details on reel specifications.
2. For other output voltages, contact Intersil marketing or local sales office.
3. These Intersil Pb-free plastic packaged products employ special Pb-free material sets; molding compounds/die attach materials and NiPdAu plate-e4 termination finish, which is RoHS compliant and compatible with both SnPb and Pb-free soldering operations. Intersil Pb-free products are MSL classified at Pb-free peak reflow temperatures that meet or exceed the Pb-free requirements of IPC/JEDEC J STD-020.
4. For Moisture Sensitivity Level (MSL), please see device information page for [ISL9016A](#). For more information on MSL please see techbrief [TB363](#).

TABLE 1. KEY DIFFERENCES BETWEEN FAMILY OF PARTS

PART NUMBER	DUAL /SINGLE	MAXIMUM OUTPUT CURRENT (mA)	OUTPUT VOLTAGES (V)
ISL9016A	Dual	150	1.2 to 2.8
ISL9021A	Single	250	0.9 to 3.3
ISL9008A	Single	150	1.5 to 3.3

Absolute Maximum Ratings

V_{IN} to GND	-0.3V to +7.1V
All Other Pins to GND	-0.3 to ($V_{IN} + 0.3$)V
ESD Rating	
Human Body Model	2kV
Charged Device Model	1.5kV
Machine Model	200V

Thermal Information

Thermal Resistance	θ_{JA} (°C/W)
6 Ld uTDFN Package (Note 5)	117.5
Junction Temperature Range	-40°C to +125°C
Operating Temperature Range	-40°C to +85°C
Storage Temperature Range	-65°C to +150°C
Pb-Free Reflow Profile (*)	see TB487

Recommended Operating Conditions

Supply Voltage (V_{IN})	1.8V to 6.5V
Each LDO Load Current	up to 150mA
Ambient Temperature Range (T_A)	-40°C to +85°C

CAUTION: Do not operate at or near the maximum ratings listed for extended periods of time. Exposure to such conditions may adversely impact product reliability and result in failures not covered by warranty.

NOTE:

- θ_{JA} is measured in free air with the component mounted on a high effective thermal conductivity test board with “direct attach” features. See Tech Brief [TB379](#).

Electrical Specifications Typical specifications are measured at the following conditions: $T_A = +25^\circ\text{C}$; $V_{IN} = (V_{OUT} + 0.5\text{V})$ to 6.5V with a minimum V_{IN} of 1.8V; $C_{IN} = 1\mu\text{F}$; $C_O = 1\mu\text{F}$. **Boldface limits apply across the operating temperature range, -40°C to +85°C.**

PARAMETER	SYMBOL	TEST CONDITIONS	MIN (Note 8)	TYP	MAX (Note 8)	UNIT
DC CHARACTERISTICS						
Supply Voltage	V_{IN}		1.8		6.5	V
UVLO Threshold	V_{UV+}			1.710	1.775	V
	V_{UV-}		1.55	1.62		
Input Quiescent Current		Quiescent condition: $I_{OUT1} = 0\mu\text{A}$; $I_{OUT2} = 0\mu\text{A}$				
	I_{DD1}	One LDO active		49	67	μA
	I_{DD2}	Both LDO active		80	100	μA
Shutdown Current	I_{DDS}	At +25°C		0.1	1.0	μA
Regulation Voltage Accuracy		$V_{IN} = V_{OUT} + 0.5\text{V}$ to 6.5V, $I_{OUT} = 10\mu\text{A}$ to 150mA, $T_A = +25^\circ\text{C}$	-0.8		+0.8	%
		$V_{IN} = V_{OUT} + 0.5\text{V}$ to 6.5V, $I_{OUT} = 10\mu\text{A}$ to 150mA, $T_A = -40^\circ\text{C}$ to +85°C	-1.8		+1.8	%
Maximum Output Current	I_{MAX}	Each LDO, Continuous	150			mA
Internal Current Limit	I_{LIM}		175	265	355	mA
Dropout Voltage (Note 6)	V_{D01}	$I_{OUT} = 150\text{mA}$; $1.2\text{V} \leq V_{OUT} \leq 2.1\text{V}$		250	425	mV
	V_{D02}	$I_{OUT} = 150\text{mA}$; $2.1\text{V} \leq V_{OUT} \leq 2.8\text{V}$		200	325	mV
	V_{D03}	$I_{OUT} = 150\text{mA}$; $2.8\text{V} \leq V_{OUT}$		120	200	mV
Thermal Shutdown Temperature	T_{SD+}			145		°C
	T_{SD-}			110		°C
AC CHARACTERISTICS						
Ripple Rejection		$I_{OUT} = 10\text{mA}$, $V_{IN} = 3.7\text{V}$ (minimum), $V_{OUT} = 2.7\text{V}$, $T_A = +25^\circ\text{C}$				
		At 1kHz		80		dB
		At 10kHz		60		dB
		At 100kHz		50		dB
		At 1MHz		45		dB
Output Noise Voltage		$V_{IN} = 4.2\text{V}$, $I_{OUT} = 10\text{mA}$, $T_A = +25^\circ\text{C}$, BW = 10Hz to 100kHz		25		μV_{RMS}

Electrical Specifications Typical specifications are measured at the following conditions: $T_A = +25^\circ\text{C}$; $V_{IN} = (V_{OUT} + 0.5\text{V})$ to 6.5V with a minimum V_{IN} of 1.8V; $C_{IN} = 1\mu\text{F}$; $C_O = 1\mu\text{F}$. **Boldface limits apply across the operating temperature range, -40°C to $+85^\circ\text{C}$. (Continued)**

PARAMETER	SYMBOL	TEST CONDITIONS	MIN (Note 8)	TYP	MAX (Note 8)	UNIT
DEVICE START-UP CHARACTERISTICS						
Device Enable Time	t_{EN}	Time from assertion of the ENx pin to when the output voltage reaches 95% of the V_{OUT} (nominal)		400	600	μs
LDO Soft-Start Ramp Rate	t_{SSR}	Slope of linear portion of LDO output voltage ramp during start-up		30	60	$\mu\text{s}/\text{V}$
EN PIN CHARACTERISTICS						
Input Low Voltage	V_{IL}	$T_A = -20^\circ\text{C}$ to $+85^\circ\text{C}$	-0.3		0.4	V
Input High Voltage	V_{IH}		1.1		$V_{IN} + 0.3$	V
Input Leakage Current	I_{IL}, I_{IH}				0.1	μA
REVERSE CURRENT CHARACTERISTICS						
Output Reverse Leakage Current (Note 7)	I_{ORLC}	$V_{IN} = 0\text{V}, V_{OUT} = 5.5\text{V}$		8	15	μA

NOTES:

- $V_{OX} = 0.98 \cdot V_{OX}(\text{NOM})$; Valid for V_{OX} greater than 1.80V.
- Output reverse leakage current is measured with V_{IN} pin grounded and V_{OUT} pin connected to 5.5V.
- Parameters with MIN and/or MAX limits are 100% tested at $+25^\circ\text{C}$, unless otherwise specified. Temperature limits established by characterization and are not production tested.

Typical Operating Performance

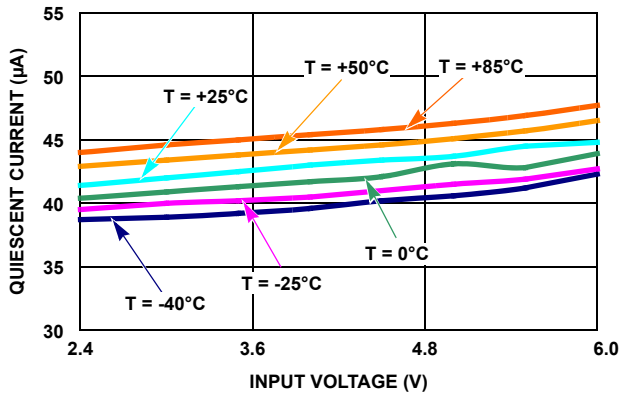

FIGURE 2. QUIESCIENT CURRENT vs INPUT VOLTAGE ($V_{OUT1} = 2.8V$, ONLY LDO1 ENABLED)

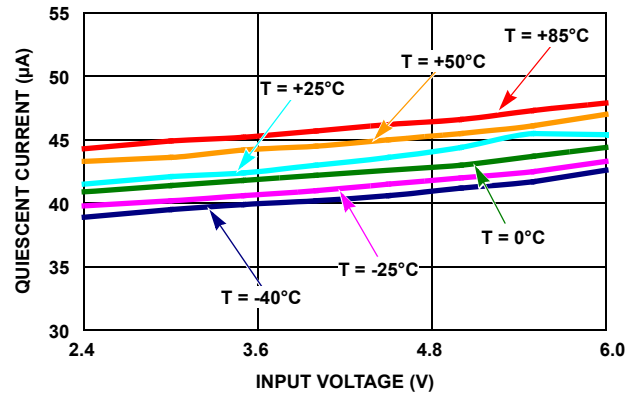

FIGURE 3. QUIESCIENT CURRENT vs INPUT VOLTAGE ($V_{OUT2} = 2.8V$, ONLY LDO2 ENABLED)

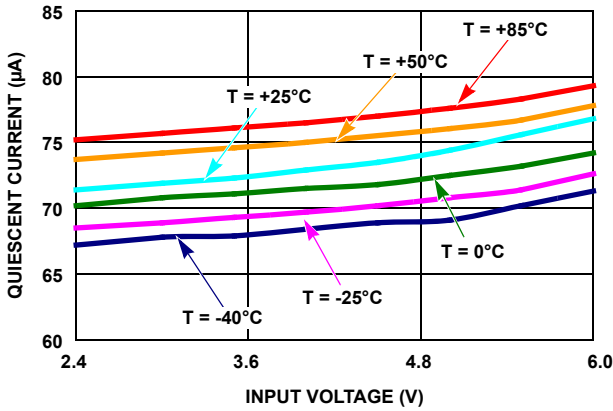

FIGURE 4. QUIESCIENT CURRENT vs INPUT VOLTAGE ($V_{OUT1} = 1.2V$, $V_{OUT2} = 2.8V$, LDO1 AND LDO2 ENABLED)

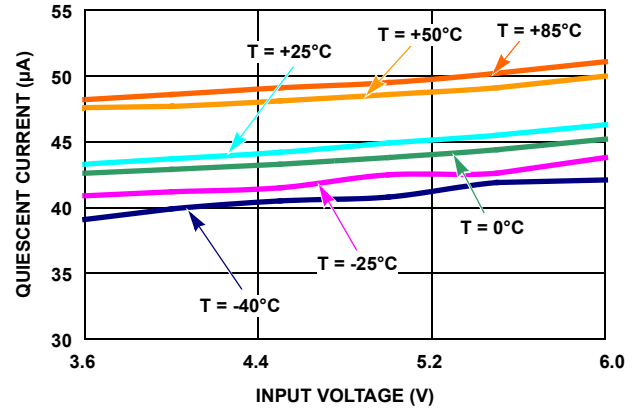

FIGURE 5. QUIESCIENT CURRENT vs INPUT VOLTAGE ($V_{OUT1} = 2.8V$, ONLY LDO1 ENABLED)

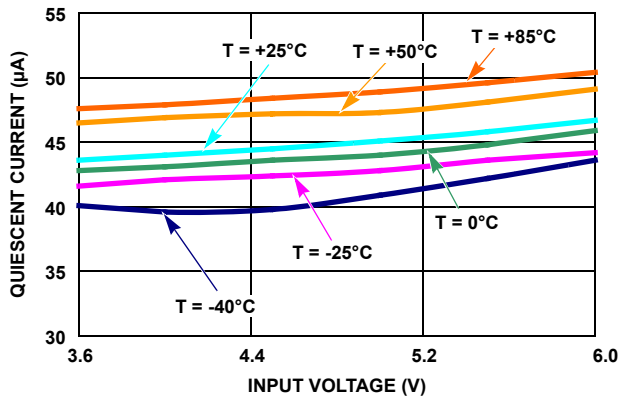

FIGURE 6. QUIESCIENT CURRENT vs INPUT VOLTAGE ($V_{OUT2} = 2.8V$, ONLY LDO2 ENABLED)

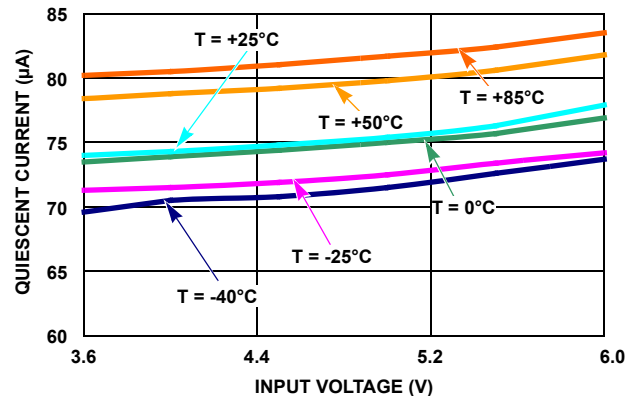

FIGURE 7. QUIESCIENT CURRENT vs INPUT VOLTAGE ($V_{OUT1} = 1.2V$, $V_{OUT2} = 2.8V$, LDO1 AND LDO2 ENABLED)

Typical Operating Performance (Continued)

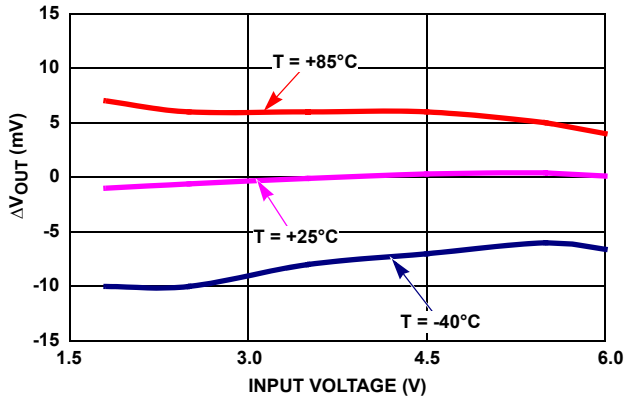

FIGURE 8. ΔV_{OUT} vs INPUT VOLTAGE ($V_{OUT_NOMINAL} = 1.2V$, $I_{OUT} = 50mA$)

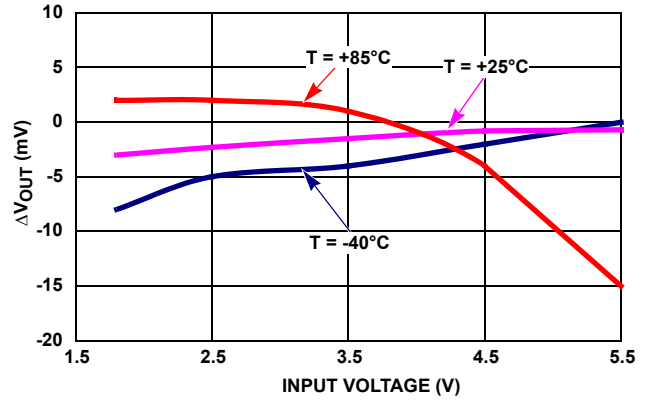

FIGURE 9. ΔV_{OUT} vs INPUT VOLTAGE ($V_{OUT_NOMINAL} = 1.2V$, $I_{OUT} = 150mA$)

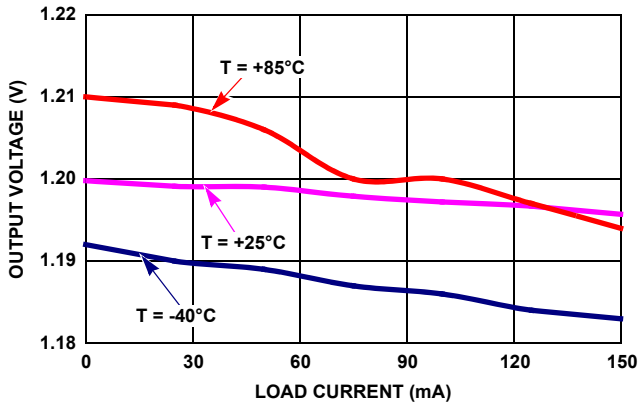

FIGURE 10. LOAD REGULATION ($V_{IN} = 1.8V$, $V_{OUT} = 1.2V$)

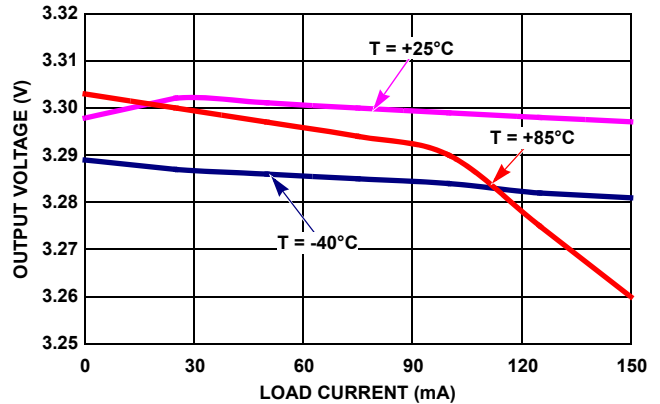

FIGURE 11. LOAD REGULATION ($V_{IN} = 4.5V$, $V_{OUT} = 2.8V$)

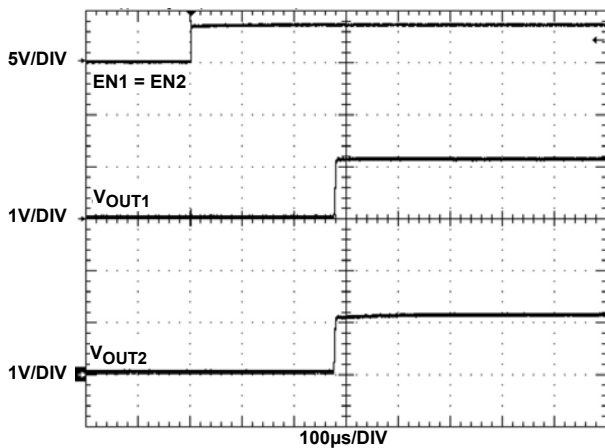

FIGURE 12. ENABLE OPERATION ($V_{IN} = 3.6V$, $V_{OUT1} = V_{OUT2} = 1.2V$)

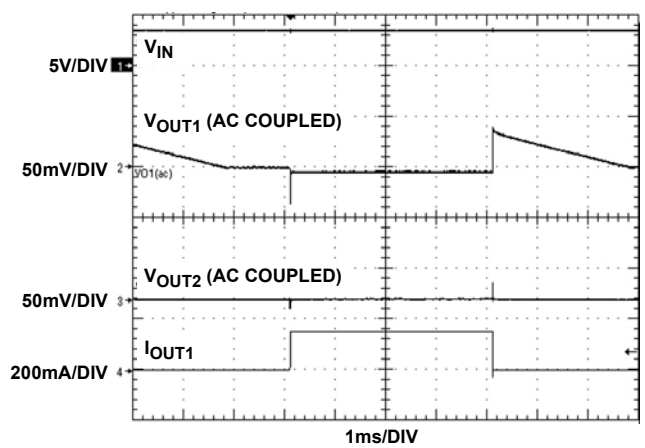

FIGURE 13. LOAD TRANSIENT RESPONSE ($V_{IN} = 3.6V$, $V_{OUT1} = 1.2V$, $V_{OUT2} = 2.8V$, I_{OUT1} 0.01mA TO 150mA)

Typical Operating Performance (Continued)

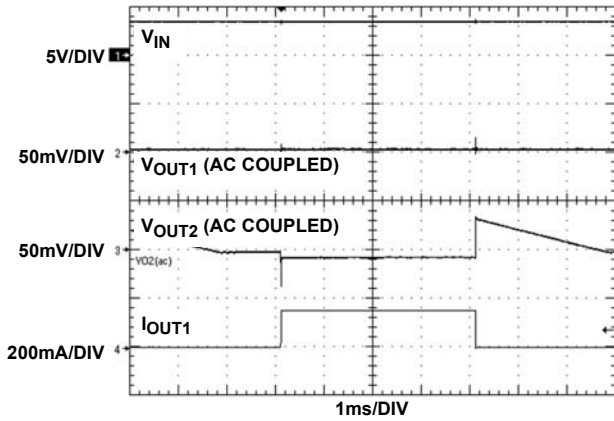

FIGURE 14. LOAD TRANSIENT RESPONSE ($V_{IN} = 3.6V$, $V_{OUT1} = 1.2V$, $V_{OUT2} = 2.8V$, I_{OUT2} 0.01mA TO 150mA)

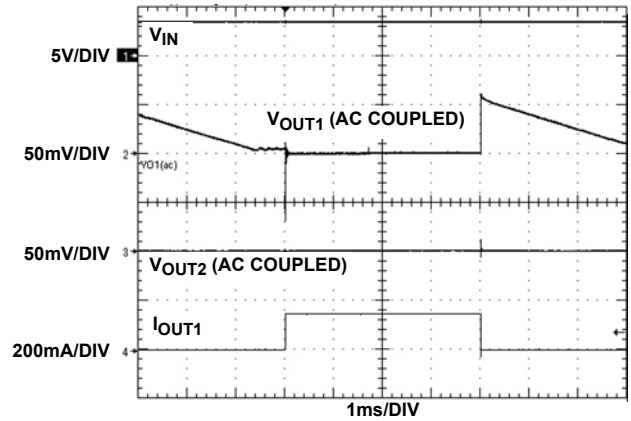

FIGURE 15. LOAD TRANSIENT RESPONSE ($V_{IN} = 3.6V$, $V_{OUT1} = 2.8V$, $V_{OUT2} = 1.8V$, I_{OUT1} 0.01mA TO 150mA)

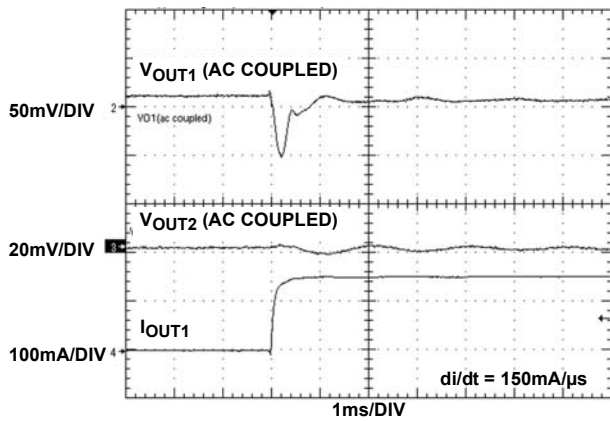

FIGURE 16. LOAD TRANSIENT RESPONSE ($V_{IN} = 1.8V$, $V_{OUT1} = 1.2V$, $V_{OUT2} = 2.8V$, I_{OUT1} 0.01mA TO 150mA)

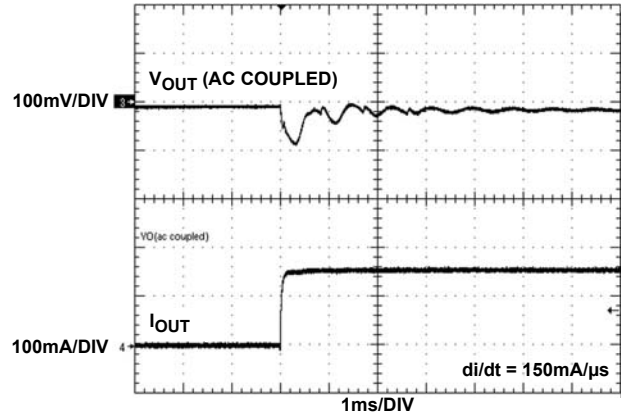

FIGURE 17. LOAD TRANSIENT RESPONSE ($V_{IN} = 3.3V$, $V_{OUT1} = 1.8V$, $V_{OUT2} = 2.8V$, I_{OUT1} 0.01mA TO 150mA)

Block Diagram

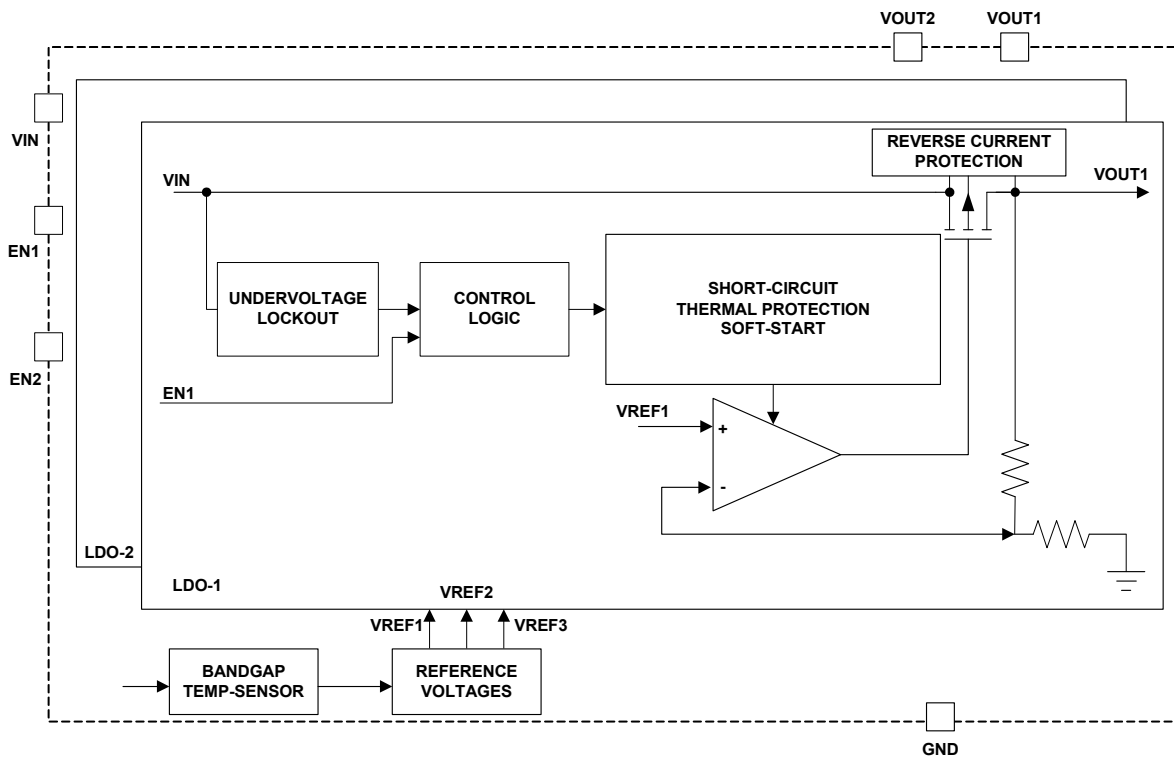

FIGURE 18. BLOCK DIAGRAM

Functional Description

The ISL9016A contains two high performance LDOs. High performance is achieved through a circuit, which delivers fast transient response to varying load conditions. In a quiescent condition, the ISL9016A adjusts its biasing to achieve the lowest standby current consumption.

The device also integrates current limit protection, thermal shutdown protection, reverse current protection and soft-start. Thermal shutdown protects the device against overheating. Soft-start limits the start-up input current surges. In some certain application circuits, the output voltage may be externally held up, meanwhile, the input voltage could be connected to ground, or connected to some voltage lower than the output side, or be left open circuit. The ISL9016A features the reverse current protection; it can limit the current flow from output to input. This protection will automatically initiate when V_{OUT} is detected to be higher than V_{IN} . When V_{IN} is pulled to ground and V_{OUT} is held at 5.5V, the current flow from V_{OUT} to V_{IN} is typically less than $8\mu\text{A}$.

Enable Control

The ISL9016A has two separate enable pins, EN1 and EN2, which independently enable/disable each of the LDO outputs. When both EN1 and EN2 are low, the whole device is in shutdown mode. In this condition, all on-chip circuits are off, and the device draws minimum current, typically less than 0.1mA. When one or both the EN pins go high, the LDO1 and/or LDO2 will be enabled accordingly based on the voltage signal applied on its related EN pin and start from the soft-start. Likewise, when one or both EN pins go low, LDO1 and/or LDO2 will be disabled based on the signal applied on its related EN

pin. A 100k Ω (or above) pull-up resistor should be connected between ENx pin and the external control voltage (as shown in the [Figure 1 on page 1](#)).

LDO Protections

The ISL9016A offers several protections, which make it ideal for using in battery-powered application circuits.

The ISL9016A provides short-circuit protection by limiting the output current to typical 265mA. When a short-circuit happens, the circuit is limited at 265mA (typical). If the short-circuit lasts long enough, the die temperature increases, and the over-temperature protection circuit will turn off the output.

When the die temperature reaches about $+145^{\circ}\text{C}$, the thermal protection starts working. Under the overheat condition, only the LDO sourcing more than 50mA will be shut off. This does not affect the operation of the other LDO. If both LDOs source more than 50mA and an overheat condition occurs, both LDO outputs will be disabled. Once the die temperature falls back to about $+110^{\circ}\text{C}$, the disabled LDOs are re-enabled and soft-start automatically takes place.

In certain applications, the following input/output situations may occur, with output voltage externally held up higher than the input voltage:

1. Input is pulled to ground
2. Input is left open circuit
3. Input is pulled to some intermediate voltage

The ISL9016A provides the reverse current protection to limit the current flow from output to input under these situations. When input is pulled to ground and output is held to 5.5V, the typical reverse current from output to input side is less than 8 μ A.

Input and Output Capacitors

The ISL9016A provides a linear regulator that has low quiescent current, fast transient response, and overall stability across the recommended operating conditions. A ceramic capacitor (X5R or X7R) with a capacitance of 1 μ F to 4.7 μ F with an ESR up to 200m Ω is suitable for the ISL9016A to maintain its output stability. The ground connection of the output capacitor should be connected directly to the GND pin of the device, and also placed close to the device. Similarly for the input capacitor, usually a 1 μ F ceramic capacitor (X5R or X7R) is suitable for most cases, but if large, fast rising-time load transient condition is expected, a higher value input capacitor may be necessary to achieve better performance.

Board Layout Recommendations

A good PCB layout will be an important step to achieve good performance. It is recommended to design the board with separate ground planes for input and output, and connect both ground planes at the GND pin of the device. Consideration should be taken when placing the components and route the trace to minimize the ground impedance, as well as keep the parasitic inductance low. Usually the input/output capacitors should be placed close to the device with good ground connection.

Revision History

The revision history provided is for informational purposes only and is believed to be accurate, but not warranted. Please go to web to make sure you have the latest revision.

DATE	REVISION	CHANGE
August 3, 2016	FN8865.0	Initial Release

About Intersil

Intersil Corporation is a leading provider of innovative power management and precision analog solutions. The company's products address some of the largest markets within the industrial and infrastructure, mobile computing and high-end consumer markets.

For the most updated datasheet, application notes, related documentation and related parts, please see the respective product information page found at www.intersil.com.

You may report errors or suggestions for improving this datasheet by visiting www.intersil.com/ask.

Reliability reports are also available from our website at www.intersil.com/support.

© Copyright Intersil Americas LLC 2016. All Rights Reserved.

All trademarks and registered trademarks are the property of their respective owners.

For additional products, see www.intersil.com/en/products.html

Intersil products are manufactured, assembled and tested utilizing ISO9001 quality systems as noted in the quality certifications found at www.intersil.com/en/support/qualandreliability.html

Intersil products are sold by description only. Intersil may modify the circuit design and/or specifications of products at any time without notice, provided that such modification does not, in Intersil's sole judgment, affect the form, fit or function of the product. Accordingly, the reader is cautioned to verify that datasheets are current before placing orders. Information furnished by Intersil is believed to be accurate and reliable. However, no responsibility is assumed by Intersil or its subsidiaries for its use; nor for any infringements of patents or other rights of third parties which may result from its use. No license is granted by implication or otherwise under any patent or patent rights of Intersil or its subsidiaries.

For information regarding Intersil Corporation and its products, see www.intersil.com