

ISL9021A

250mA Single LDO with Low I<sub>Q</sub>, Low Noise and High PSRR LDO

FN7845  
Rev 3.00  
December 20, 2012

The ISL9021A is a single LDO, which provides high performance, low input voltage and high PSRR. It delivers guaranteed continuous 250mA load current and is stable with 1μF to 4.7μF of output capacitance (±30%) with an ESR range of 5mΩ to 400mΩ.

The input voltage range for the ISL9021A is between 1.5V to 5.5V and the output voltage comes in many fixed voltage options with ±1.8% accuracy over-temperature, line and load ranges. The ISL9021A has typical PSRR of 75dB @ 10kHz and 50dB @ 1MHz.

The reverse current protection feature prevents current from flowing back to the power source when the output voltage is pulled higher than the input.

The ISL9021A is offered in tiny 4-bump 0.975mmx1.155mm WLCSP and 1.6mmx1.6mm 6 Ld μTDFN packages.

**Related Literature**

- See [FN6867](#), ISL9021 “250mA Single LDO with Low IQ, Low Noise and High PSRR LDO”

**Features**

- High performance LDO with 250mA guaranteed continuous output current
- Input voltage range: 1.5V to 5.5V
- Output voltage range: 1.2V to 3.3V
- High PSRR: 75dB @ 10kHz, 50dB @ 1MHz
- Low quiescent current: 35μA
- Dropout voltage: <150mV @ 250mA
- Stable with 1μF to 4.7μF output capacitance (±30%) with an ESR range of 5mΩ to 400mΩ
- ±1.8% output accuracy over-temperature/load/line
- Soft-start limits input current surge during enable
- Current limit and overheat protection
- -40°C to +85°C operating temperature range
- Available in 0.975mmx1.155mm 4-bump WLCSP package and 1.6mmx1.6mm 6 Ld μTDFN
- Pb-free (RoHS compliant)

**Applications**

- PDAs, cell phones and smart phones
- Portable instruments, MP3 players
- Handheld devices including medical handheld

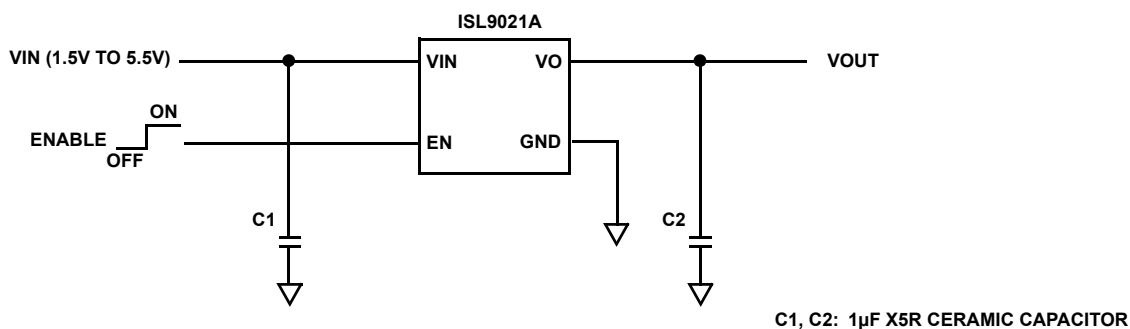
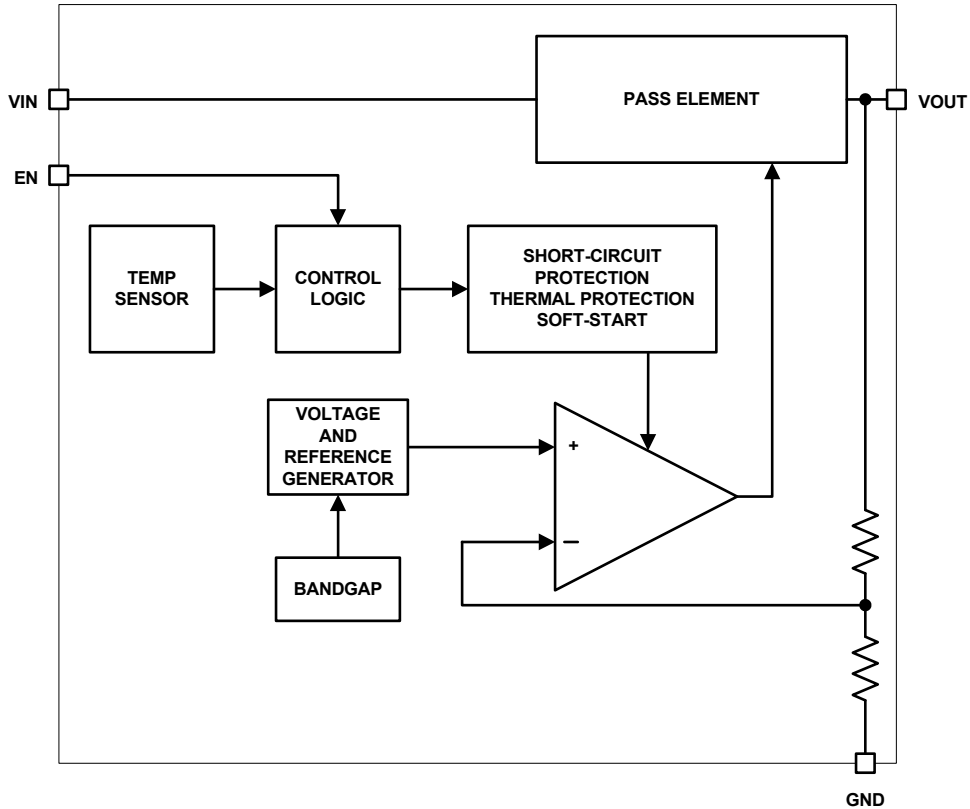

FIGURE 1. TYPICAL APPLICATION

## Block Diagram



## Pin Configurations

ISL9021A  
(6 LD 1.6x1.6  $\mu$ TDFN)  
TOP VIEW

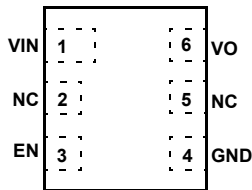

ISL9021A  
(4 BALL 0.975x1.155 WLCSP)  
TOP VIEW

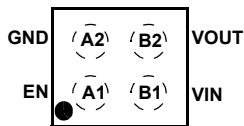

## Pin Descriptions

PIN NAME	$\mu$ TDFN PIN #	WLCSP PIN #	DESCRIPTION
VIN	1	B1	IC Supply/LDO Input. Connect a 1 $\mu$ F capacitor to GND.
NC	2, 5	-	No Connect.
GND	4	A2	System ground pin.
EN	3	A1	LDO Enable. When this signal goes high, the LDO is turned on.
VO, VOUT	6	B2	LDO Output. Connect a 1 $\mu$ F to 4.7 $\mu$ F capacitor to GND.
PAD	-	-	For $\mu$ TDFN package option only. Connect it to the system ground.

## Ordering Information

PART NUMBER (Notes 1, 4)	PART MARKING	V <sub>O</sub> VOLTAGE (V)	TEMP RANGE (°C)	PACKAGE Tape & Reel (Pb-free)	PKG. DWG. #
ISL9021AIINZ-T (Note 2)	21AN	3.3	-40 °C to +85 °C	4 Ball 0.975x1.155 WLCSP	W2x2.4
ISL9021AIIUZ-T (Note 2)	21AU	3.1	-40 °C to +85 °C	4 Ball 0.975x1.155 WLCSP	W2x2.4
ISL9021AIIMZ-T (Note 2)	21AM	3.0	-40 °C to +85 °C	4 Ball 0.975x1.155 WLCSP	W2x2.4
ISL9021AIIKZ-T (Note 2)	21AK	2.85	-40 °C to +85 °C	4 Ball 0.975x1.155 WLCSP	W2x2.4
ISL9021AIIFZ-T (Note 2)	21AF	2.5	-40 °C to +85 °C	4 Ball 0.975x1.155 WLCSP	W2x2.4
ISL9021AIICZ-T (Note 2)	21AC	1.8	-40 °C to +85 °C	4 Ball 0.975x1.155 WLCSP	W2x2.4
ISL9021AIIBZ-T (Note 2)	21AB	1.5	-40 °C to +85 °C	4 Ball 0.975x1.155 WLCSP	W2x2.4
ISL9021AIIWZ-T (Note 2)	21AW	1.2	-40 °C to +85 °C	4 Ball 0.975x1.155 WLCSP	W2x2.4
ISL9021AIRUNZ-T (Note 3)	V6	3.3	-40 °C to +85 °C	6 Ld µTDFN	L6.1.6x1.6
ISL9021AIRUNZ-T7A (Note 3)	V6	3.3	-40 °C to +85 °C	6 Ld µTDFN	L6.1.6x1.6
ISL9021AIRUMZ-T (Note 3)	V5	3.0	-40 °C to +85 °C	6 Ld µTDFN	L6.1.6x1.6
ISL9021AIRUMZ-T7A (Note 3)	V5	3.0	-40 °C to +85 °C	6 Ld µTDFN	L6.1.6x1.6
ISL9021AIRUKZ-T (Note 3)	V4	2.85	-40 °C to +85 °C	6 Ld µTDFN	L6.1.6x1.6
ISL9021AIRUKZ-T7A (Note 3)	V4	2.85	-40 °C to +85 °C	6 Ld µTDFN	L6.1.6x1.6
ISL9021AIRUJZ-T (Note 3)	V3	2.8	-40 °C to +85 °C	6 Ld µTDFN	L6.1.6x1.6
ISL9021AIRUJZ-T7A (Note 3)	V3	2.8	-40 °C to +85 °C	6 Ld µTDFN	L6.1.6x1.6
ISL9021AIRUFZ-T (Note 3)	V2	2.5	-40 °C to +85 °C	6 Ld µTDFN	L6.1.6x1.6
ISL9021AIRUFZ-T7A (Note 3)	V2	2.5	-40 °C to +85 °C	6 Ld µTDFN	L6.1.6x1.6
ISL9021AIRUCZ-T (Note 3)	V1	1.8	-40 °C to +85 °C	6 Ld µTDFN	L6.1.6x1.6
ISL9021AIRUCZ-T7A (Note 3)	V1	1.8	-40 °C to +85 °C	6 Ld µTDFN	L6.1.6x1.6
ISL9021AIRUBZ-T (Note 3)	V0	1.5	-40 °C to +85 °C	6 Ld µTDFN	L6.1.6x1.6
ISL9021AIRUBZ-T7A (Note 3)	V0	1.5	-40 °C to +85 °C	6 Ld µTDFN	L6.1.6x1.6
ISL9021AIRUWZ-T (Note 3)	V7	1.2	-40 °C to +85 °C	6 Ld µTDFN	L6.1.6x1.6
ISL9021AIRUWZ-T7A (Note 3)	V7	1.2	-40 °C to +85 °C	6 Ld µTDFN	L6.1.6x1.6
ISL9021AIRUYZ-T (Note 3)	V8	0.9	-40 °C to +85 °C	6 Ld µTDFN	L6.1.6x1.6
ISL9021AIRUYZ-T7A (Note 3)	V8	0.9	-40 °C to +85 °C	6 Ld µTDFN	L6.1.6x1.6
ISL9021AIINZ-EVZ	Evaluation Board for ISL9021AIINZ				
ISL9021AIIUZ-EVZ	Evaluation Board for ISL9021AIIUZ				
ISL9021AIIMZ-EVZ	Evaluation Board for ISL9021AIIMZ				
ISL9021AIIKZ-EVZ	Evaluation Board for ISL9021AIIKZ				
ISL9021AIIFZ-EVZ	Evaluation Board for ISL9021AIIFZ				
ISL9021AIICZ-EVZ	Evaluation Board for ISL9021AIICZ				
ISL9021AIIBZ-EVZ	Evaluation Board for ISL9021AIIBZ				
ISL9021AIIWZ-EVZ	Evaluation Board for ISL9021AIIWZ				
ISL9021AIRUNZ-EVZ	Evaluation Board for ISL9021AIRUNZ				
ISL9021AIRUMZ-EVZ	Evaluation Board for ISL9021AIRUMZ				
ISL9021AIRUKZ-EVZ	Evaluation Board for ISL9021AIRUKZ				
ISL9021AIRUJZ-EVZ	Evaluation Board for ISL9021AIRUJZ				

## Ordering Information (Continued)

PART NUMBER (Notes 1, 4)	PART MARKING	V <sub>O</sub> VOLTAGE (V)	TEMP RANGE (°C)	PACKAGE Tape & Reel (Pb-free)	PKG. DWG. #
ISL9021AIRUFZ-EVZ	Evaluation Board for ISL9021AIRUFZ				
ISL9021AIRUCZ-EVZ	Evaluation Board for ISL9021AIRUCZ				
ISL9021AIRUBZ-EVZ	Evaluation Board for ISL9021AIRUBZ				
ISL9021AIRUWZ-EVZ	Evaluation Board for ISL9021AIRUWZ				
ISL9021AIRUYZ-EVZ	Evaluation Board for ISL9021AIRUYZ				

### NOTES:

1. Please refer to [TB347](#) for details on reel specifications.
2. These Intersil Pb-free WLCSP and BGA packaged products employ special Pb-free material sets; molding compounds/die attach materials and SnAgCu - e1 solder ball terminals, which are RoHS compliant and compatible with both SnPb and Pb-free soldering operations. Intersil Pb-free WLCSP and BGA packaged products are MSL classified at Pb-free peak reflow temperatures that meet or exceed the Pb-free requirements of IPC/JEDEC J STD-020.
3. These Intersil Pb-free plastic packaged products employ special Pb-free material sets; molding compounds/die attach materials and NiPdAu plate - e4 termination finish, which is RoHS compliant and compatible with both SnPb and Pb-free soldering operations. Intersil Pb-free products are MSL classified at Pb-free peak reflow temperatures that meet or exceed the Pb-free requirements of IPC/JEDEC J STD-020.
4. For Moisture Sensitivity Level (MSL), please see device information page for [ISL9021A](#). For more information on MSL please see techbrief [TB363](#).

## Absolute Maximum Ratings

Supply Voltage (VIN) .....	+6.5V
All Other Pins .....	-0.3 to (VIN + 0.3)V

## Recommended Operating Conditions

Ambient Temperature Range (TA) .....	-40 °C to +85 °C
Supply Voltage (VIN) .....	1.5 to 5.5V
ESD Rating	
Human Body Model .....	5000V
Machine Model .....	250V
Charged Device Model .....	2200V
Latch-Up Passed at +85 °C .....	100mA

## Thermal Information

Thermal Resistance (Typical)	$\theta_{JA}$ (°C/W)	$\theta_{JC}$ (°C/W)
4 Ball WLCSP (Note 5) .....	135.64	N/A
6 Lead $\mu$ TDFN (Notes 6, 7) .....	230	93
Junction Temperature Range .....	-40 °C to +125 °C	
Operating Temperature Range .....	-40 °C to +85 °C	
Storage Temperature Range .....	-65 °C to +150 °C	
Pb-Free Reflow Profile .....	see link below	
	<a href="http://www.intersil.com/pbfree/Pb-FreeReflow.asp">http://www.intersil.com/pbfree/Pb-FreeReflow.asp</a>	

CAUTION: Do not operate at or near the maximum ratings listed for extended periods of time. Exposure to such conditions may adversely impact product reliability and result in failures not covered by warranty.

### NOTES:

- $\theta_{JA}$  is measured in free air with the component mounted on a high effective thermal conductivity test board with “direct attach” features. See Tech Brief [TB379](#).
- $\theta_{JA}$  is measured with the component mounted on a high effective thermal conductivity test board in free air. See Tech Brief [TB379](#) for details.
- For  $\theta_{JC}$ , the “case temp” location is taken at the package top center.

**Electrical Specifications** TA = -40 °C to +85 °C; VIN = (VO + 0.5V) to 5.5V with a minimum VIN of 1.5V; CIN = 1 $\mu$ F; CO = 1 $\mu$ F. **Boldface limits apply over the operating temperature range, -40 °C to +85 °C.**

PARAMETER	SYMBOL	TEST CONDITIONS	MIN (Note 10)	TYP	MAX (Note 10)	UNIT
<b>DC CHARACTERISTICS</b>						
Supply Voltage	VIN		<b>1.5</b>		<b>5.5</b>	V
VIN Undervoltage Lockout Threshold	VUVLO+	VIN Rising		1.425	<b>1.5</b>	V
	VUVLO-	VIN Falling	<b>1.3</b>	1.375		V
Ground Current	IDD	Output Enabled; IO = 0; VIN = 1.5V to 5.5V		35	<b>50</b>	$\mu$ A
Shutdown Current	IDDS	VIN = 5.5V, EN = Low, IO = 0		0.1	<b>1.0</b>	$\mu$ A
Output Voltage Accuracy		VIN = VO + 0.5V to 5.5V, IO = 1mA to 250mA, TJ = +25 °C	-0.8		+0.8	%
		VIN = VO + 0.5V to 5.5V, IO = 1mA to 250mA, TJ = -40 °C to +125 °C	<b>-1.8</b>		<b>+1.8</b>	%
Maximum Output Current	IMAX	Continuous	<b>250</b>			mA
Internal Current Limit	ILIM		<b>260</b>			mA
Dropout Voltage (Notes 8, 9)	VDO	IO = 250mA; VO > 1.8V		150	<b>250</b>	mV
Thermal Shutdown Temperature	TSD			160		°C
Thermal Shutdown Hysteresis				20		°C
<b>AC CHARACTERISTICS</b>						
Ripple Rejection (Note 8)		VIN = 4.5V, VO = 3.3V @ 1kHz		60		dB
		VIN = 4.5V, VO = 3.3V @ 10kHz		75		dB
		VIN = 4.5V, VO = 3.3V @ 1MHz		50		dB
Output Noise Voltage (Note 8)		VIN = 4.2V, TA = +25 °C, BW = 10Hz to 100kHz, IO = 10mA		8.5*VO		$\mu$ V <sub>RMS</sub>
<b>DEVICE START-UP CHARACTERISTICS</b>						
Device Enable Time	tEN	Time from assertion of the EN pin to when the output voltage reaches 95% of the VO (nom)		250	<b>600</b>	$\mu$ s
LDO Soft-start Ramp Rate	tSSR	Slope of linear portion of LDO output voltage ramp during start-up		30	<b>60</b>	$\mu$ s/V

**Electrical Specifications**  $T_A = -40^\circ\text{C}$  to  $+85^\circ\text{C}$ ;  $V_{IN} = (V_O + 0.5\text{V})$  to  $5.5\text{V}$  with a minimum  $V_{IN}$  of  $1.5\text{V}$ ;  $C_{IN} = 1\mu\text{F}$ ;  $C_O = 1\mu\text{F}$ . **Boldface limits apply over the operating temperature range,  $-40^\circ\text{C}$  to  $+85^\circ\text{C}$ . (Continued)**

PARAMETER	SYMBOL	TEST CONDITIONS	MIN (Note 10)	TYP	MAX (Note 10)	UNIT
<b>EN LOGIC CHARACTERISTICS</b>						
Input Low Voltage	$V_{IL}$				<b>0.4</b>	V
Input High Voltage	$V_{IH}$		<b>1.1</b>			V
Input Leakage Current	$I_{IL}, I_{IH}$				<b>0.1</b>	$\mu\text{A}$

NOTES:

- 8. Limits established by characterization and are not production tested.
- 9. Dropout voltage is measured as  $V_{IN} - V_O$ , when  $V_O$  is 4% lower than the value of  $V_O$
- 10. Parameters with MIN and/or MAX limits are 100% tested at  $+25^\circ\text{C}$ , unless otherwise specified. Temperature limits established by characterization and are not production tested.

**Typical Operating Performance**

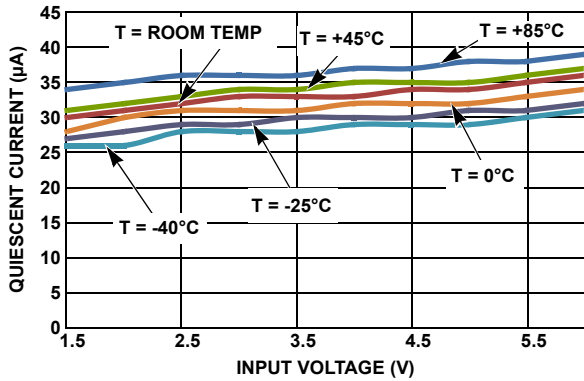

FIGURE 2. QUIESCENT CURRENT vs INPUT VOLTAGE ( $V_{OUT} = 0.9\text{V}$ )

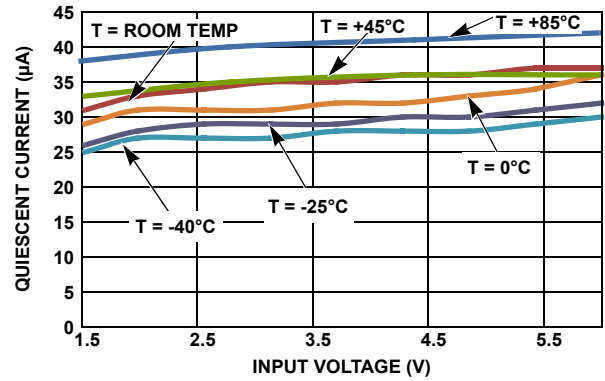

FIGURE 3. QUIESCENT CURRENT vs INPUT VOLTAGE ( $V_{OUT} = 1.85\text{V}$ )

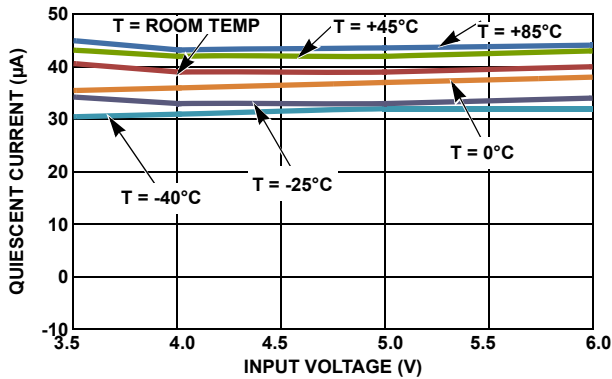

FIGURE 4. QUIESCENT CURRENT vs INPUT VOLTAGE ( $V_{OUT} = 3.3\text{V}$ )

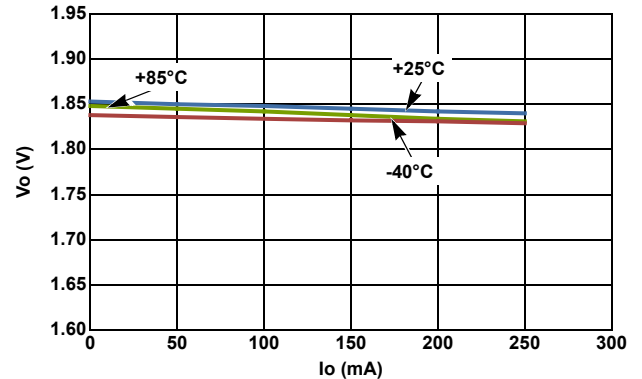

FIGURE 5. LOAD REGULATION vs TEMPERATURE ( $V_{OUT} = 1.85\text{V}$ )

**Typical Operating Performance** (Continued)

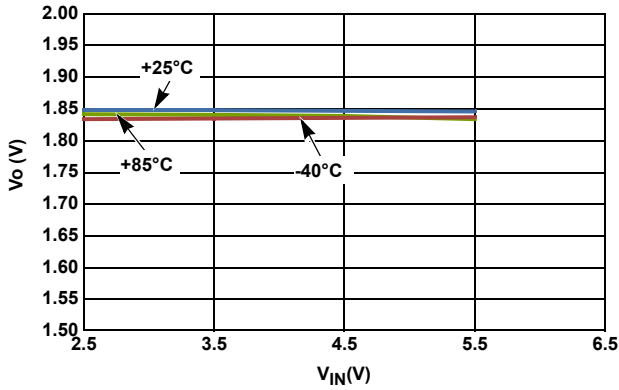

FIGURE 6. LINE REGULATION vs TEMPERATURE ( $V_{OUT} = 1.85V$ )

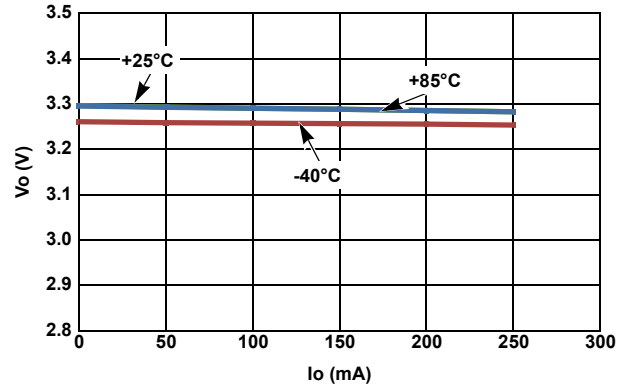

FIGURE 7. LOAD REGULATION vs TEMPERATURE ( $V_{OUT} = 3.3V$ )

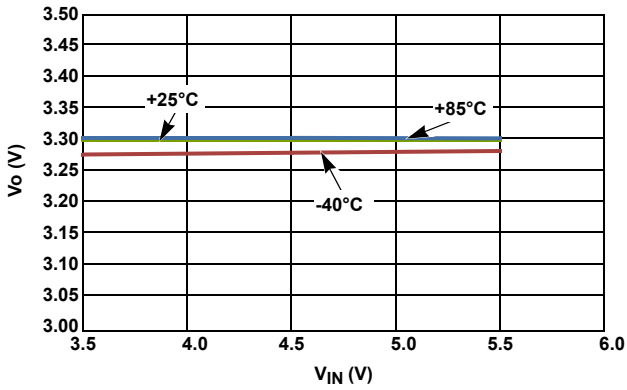

FIGURE 8. LINE REGULATION vs TEMPERATURE ( $V_{OUT} = 3.3V$ )

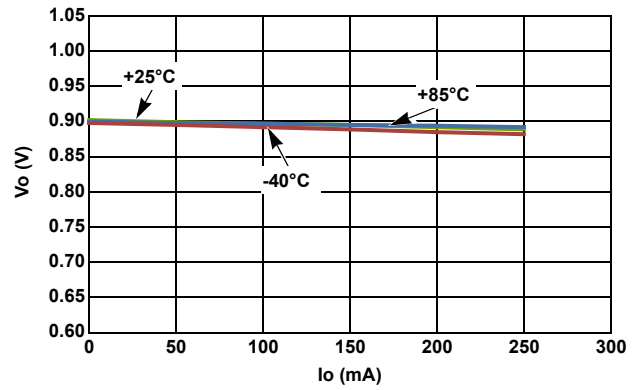

FIGURE 9. LOAD REGULATION vs TEMPERATURE ( $V_{OUT} = 0.9V$ )

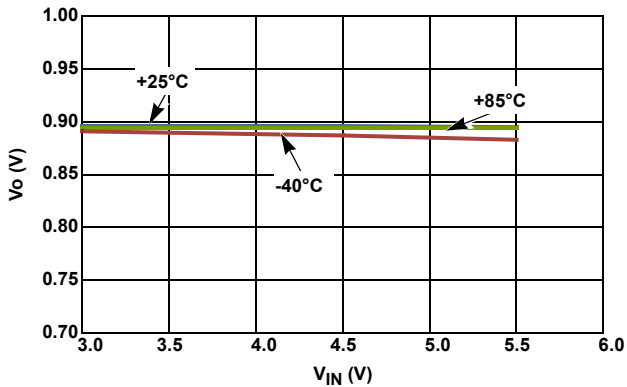

FIGURE 10. LINE REGULATION vs TEMPERATURE ( $V_{OUT} = 0.9V$ )

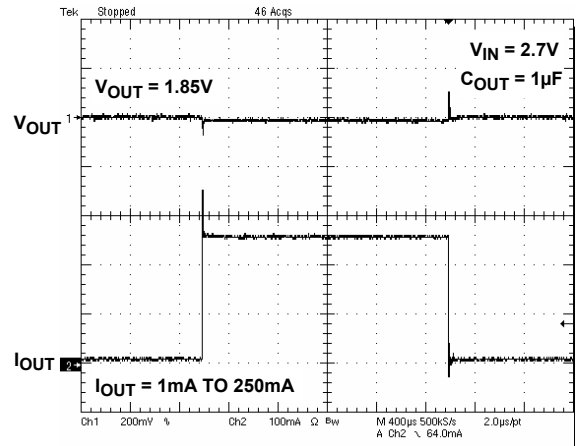

FIGURE 11. LOAD TRANSIENT RESPONSE

## Typical Operating Performance (Continued)

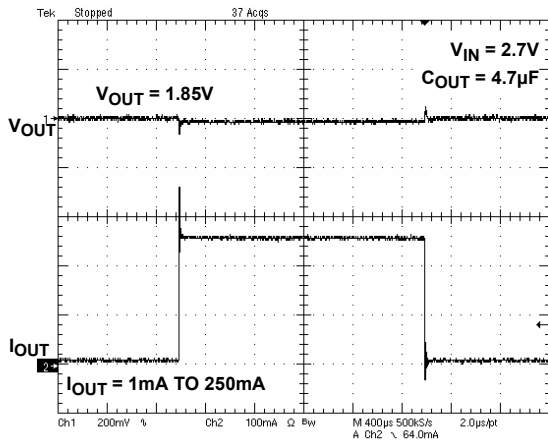

FIGURE 12. LOAD TRANSIENT RESPONSE

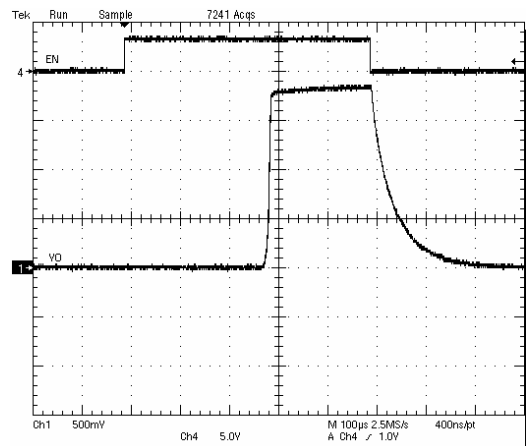

FIGURE 13. ENABLE FUNCTION ( $V_{IN} = 3.6V$ ,  $V_{OUT} = 1.85V$ ,  $C_{OUT} = 1\mu F$ )

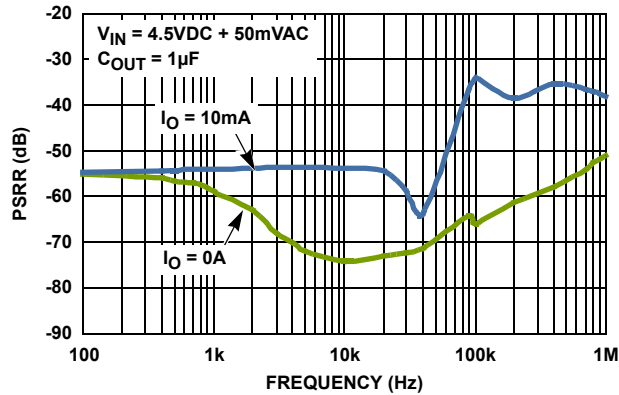

FIGURE 14. POWER SUPPLY REJECTION vs FREQUENCY



---

## Functional Description

The ISL9021A is a high performance low-dropout regulator (LDO) with 250mA sourcing capability. The extra low ground current makes this part a good choice for handheld product applications. The device also incorporates overcurrent, thermal shutdown, reverse current protections, and soft-start features.

Thermal shutdown protects the device against overheating. Soft-start limits the start-up input current surges. In some applications, the output voltage may be externally pulled higher than the input, or the input voltage could be connected to ground, or connected to some voltage lower than the output side. The ISL9021A features reverse current protection; that can block the reverse current from output to input.

### Enable Control

The ISL9021A has an enable pin. When EN is low, the IC is in shutdown mode. In this condition, all on-chip circuits are off, and the device draws minimum current, typically less than 0.1 $\mu$ A(typ). Driving this pin high will turn on the device.

### LDO Protections

The ISL9021A offers several protection functions, making it ideal for use in battery-powered applications. The ISL9021A provides short-circuit protection by limiting the output current at current limit of 260mA (min). If the short circuit lasts long enough, the die temperature increases, and the over-temperature protection circuit will shut down the output. When the die temperature reaches about +145°C, thermal protection starts to work with output being loaded with at least 50mA. Once the die temperature drops to about +110°C, the LDO will resume operation beginning with a soft-start.

The ISL9021A's reverse current protection is intended to block reverse conduction if output voltage is higher than input voltage.

### Input and Output Capacitors

The ISL9021A provides a linear regulator that has low quiescent current, fast transient response, and overall stable operation across the recommended operating conditions. A ceramic capacitor (X5R or X7R) with a capacitance of 1 $\mu$ F to 4.7 $\mu$ F with an ESR up to 400m $\Omega$  is suitable for the ISL9021A to maintain its output stability. The ground connection of the output capacitor should be routed directly to the GND pin of the device, and also placed close to the IC. Similarly for the input capacitor, usually a 1 $\mu$ F ceramic capacitor (X5R or 7R) is suitable for most cases, but if a large, fast rising load transient condition is expected, a higher value input capacitor may be necessary to achieve satisfactory performance.

### Board Layout Recommendations

A good PCB layout is an important step to achieve good performance. It is recommended to design the board with separate ground planes for input and output, and connect both ground planes at the GND pin of the IC. Consideration should be taken when placing the components and routing the trace to minimize the ground impedance, and keep the parasitic inductance low. Usually the input/output capacitors should be placed as close to the IC as possible with a good ground connection.

## Revision History

The revision history provided is for informational purposes only and is believed to be accurate, but not warranted. Please go to web to make sure you have the latest revision.

DATE	REVISION	CHANGE
December 17, 2012	FN7845.3	Added evaluation boards and ISL9021AIIUZ-T to "Ordering Information" on page 3.
December 2, 2011	FN7845.2	Changed CSP package dimension from "2mmx2mm" to "0.975mmx1.155mm" on page 1 to page 3.
October 7, 2011	FN7845.1	Updated "Ordering Information" on page 3 by adding ISL9021AIRUYZ-T and ISL9021AIRUYZ-T7A parts. Made corrections to part markings and added -T7A parts.
May 27, 2011	FN7845.0	Initial Release

## About Intersil

Intersil Corporation is a leader in the design and manufacture of high-performance analog, mixed-signal and power management semiconductors. The company's products address some of the fastest growing markets within the industrial and infrastructure, personal computing and high-end consumer markets. For more information about Intersil or to find out how to become a member of our winning team, visit our website and career page at [www.intersil.com](http://www.intersil.com).

For a complete listing of Applications, Related Documentation and Related Parts, please see the respective product information page. Also, please check the product information page to ensure that you have the most updated datasheet: [ISL9021A](#)

To report errors or suggestions for this datasheet, please go to: [www.intersil.com/askourstaff](http://www.intersil.com/askourstaff)

Reliability reports are available from our website at: <http://rel.intersil.com/reports/search.php>

© Copyright Intersil Americas LLC 2011-2012. All Rights Reserved.  
All trademarks and registered trademarks are the property of their respective owners.

For additional products, see [www.intersil.com/en/products.html](http://www.intersil.com/en/products.html)

Intersil products are manufactured, assembled and tested utilizing ISO9001 quality systems as noted in the quality certifications found at [www.intersil.com/en/support/qualandreliability.html](http://www.intersil.com/en/support/qualandreliability.html)

*Intersil products are sold by description only. Intersil may modify the circuit design and/or specifications of products at any time without notice, provided that such modification does not, in Intersil's sole judgment, affect the form, fit or function of the product. Accordingly, the reader is cautioned to verify that datasheets are current before placing orders. Information furnished by Intersil is believed to be accurate and reliable. However, no responsibility is assumed by Intersil or its subsidiaries for its use; nor for any infringements of patents or other rights of third parties which may result from its use. No license is granted by implication or otherwise under any patent or patent rights of Intersil or its subsidiaries.*

For information regarding Intersil Corporation and its products, see [www.intersil.com](http://www.intersil.com)

# Package Outline Drawing

## L6.1.6x1.6

6 LEAD ULTRA THIN DUAL FLAT NO-LEAD COL PLASTIC PACKAGE (UTDFN COL)

Rev 1, 11/07

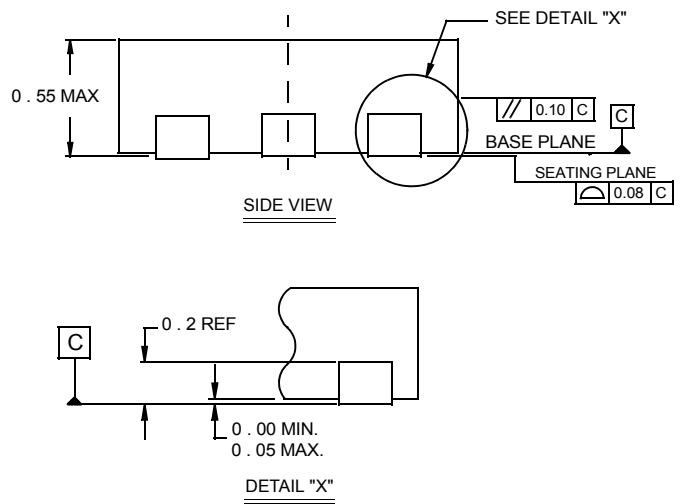
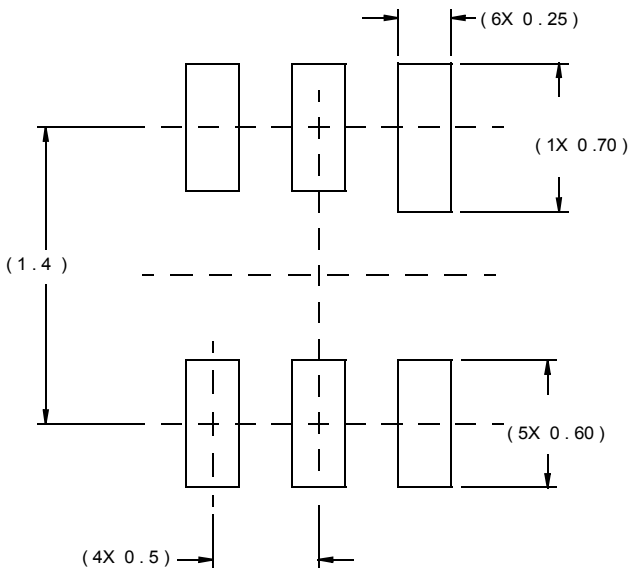
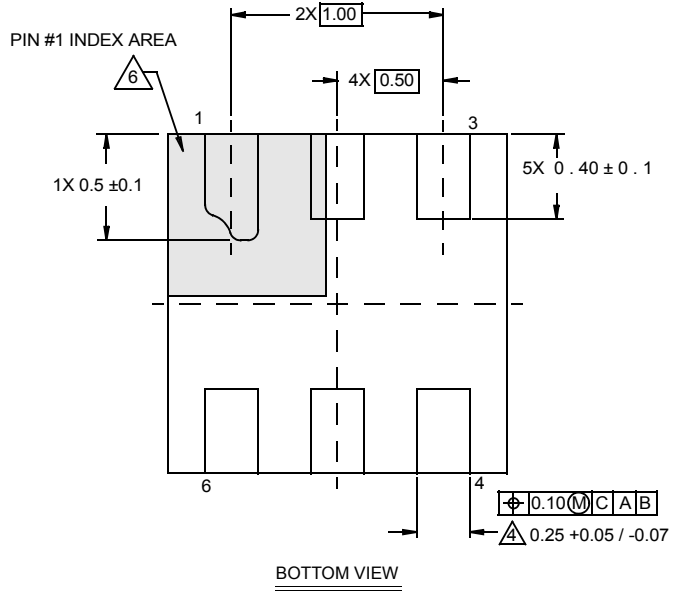
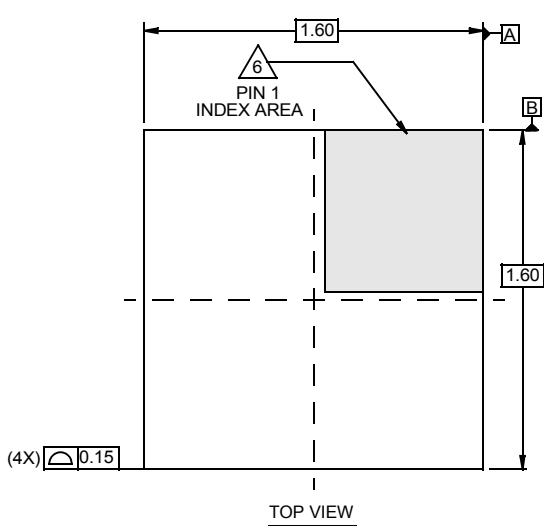

NOTES:

1. Dimensions are in millimeters.  
Dimensions in ( ) for Reference Only.
2. Dimensioning and tolerancing conform to AMSE Y14.5m-1994.
3. Unless otherwise specified, tolerance : Decimal ± 0.05
4. Dimension b applies to the metallized terminal and is measured between 0.15mm and 0.30mm from the terminal tip.
5. Tiebar shown (if present) is a non-functional feature.
6. The configuration of the pin #1 identifier is optional, but must be located within the zone indicated. The pin #1 identifier may be either a mold or mark feature.