

The ISL9206 evaluation kit provides a convenient tool to evaluate the ISL9206 Flexihash™ engine for authentication. The evaluation kit contains four items:

- A Compact Disk (CD) with the evaluation system software for Win98 SE, Win ME, 2000, or XP.
- An ISL6296 interface board that connects a USB port to the XSD bus.
- Two evaluation boards with the ISL9206 part.
- A cable to connect the interface board to the evaluation board.

The ISL9206 evaluation kit is identical to the ISL6296 evaluation kit except the authentication algorithms between the two parts. The evaluation system software is designed for both evaluation kits. The ISL9206 Evaluation System software gives the user complete control of the ISL9206. The interface board translates the PC commands to XSD commands and provides the power to the ISL9206 using the USB bus power. No additional power supply is required to perform the evaluation. An oscilloscope helps to monitor the XSD bus activity. This application note serves as the user manual of the evaluation kit.

NOTE: Please email to cwong03@intersil.com if you find bugs during evaluation or have suggestions.

ISL9206EVAL1 Evaluation Board

The ISL9206EVAL1 board is 1cm x 4cm single-layer board, as shown in Figure 1. The schematic, layout and bill-of-materials (BOM) are given in Appendix B. The board has 5 test points to allow the user conveniently hooking up the scope probes or other test equipment. Two of them are connected to the ground and the remaining three connect to the other three pins of the ISL9206.

ISL9206 Interface Board

The Interface board is also shown in Figure 1. One side of the board is a USB connector and the other side is a three-pin connector for the XSD bus. The XSD-bus connector contains power, XSD and ground lines. The power line provides power to the ISL9206EVAL1 and its voltage is adjustable through the Configuration tab in the evaluation system software (See Evaluation System Software section for more details). The schematic, layout and BOM are given in Appendix C.

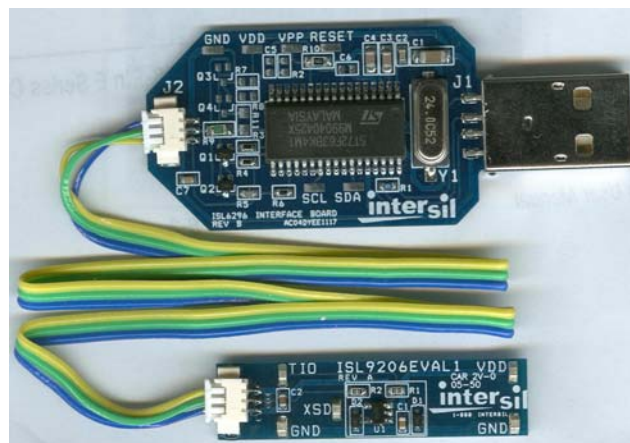

FIGURE 1. PHOTO OF THE EVALUATION KIT (CD NOT INCLUDED)

Software Installation

Installing the software is straightforward and requires only two steps:

1. Open the folder named *Installation* in the CD;
2. Double click *SETUP.EXE* and follow the instructions.

Evaluation Kit Setup

The following are steps for setting up the evaluation system:

1. Connect the ISL9206EVAL1 board to the ISL6296 Interface Board using the provided cable.
2. Plug the Interface Board to the USB port. The Windows Operating System (OS) will automatically recognize the board as a Human Interface Device.
3. Follow the steps given in Appendix A to confirm the installation of the Interface Board in the OS. This step is optional.
4. Hook up a scope probe to the XSD test point to monitor the XSD bus activity.
5. Start up the ISL9206 Evaluation System software that was installed a moment ago and you are ready to evaluate the ISL9206.

Evaluation System Software

When the software is initially started, it asks the user to select either to evaluate the ISL6296 or the ISL9206, as shown in Figure 2. The screens for both parts are identical except the titles of the windows.

The software has five major functional tabs to provide all necessary tools for the evaluation. Figure 7 to 11 show the screen shots for each tab. This section first discusses a few things the user needs to know before using the software, and then explains in detail how to use each tab of the software.



FIGURE 2. SCREEN SHOT OF THE STARTUP SCREEN

Device Address and XSD Bus Speed

Before evaluating the ISL9206, the user needs to confirm that the XSD bus speed of the host matches the speed of the ISL9206, and the device address (0 or 1) in the ISL9206 is set to the proper value. The default configuration (DCFG) address (at bank 0, address 0) contains the device configuration when it is powered up. When an ISL9206 is shipped from the factory, the DCFG is set to the value given in Table 1. Users can always start with the default configuration. Once the two ends can communicate properly, the user can start using the tools. Most part of the evaluation software only addresses device '0'. If the device address is not '0', the user needs to use the XSD Access tab to change the address to '0'. Appendix D provides the techniques if using the default configuration could not make the PC and the ISL9206 talk properly.

TABLE 1. DCFG DEFAULT VALUE WHEN SHIPPED FROM FACTORY

Name	Bit 7	Bit 6	Bit 5	Bit 4	Bit 3	Bit 2	Bit 1	Bit 0
Value	0	0	0	1	1	1	0	0
Function	DAB[1:0]		SPD[1:0]		eINT	ASLP	SLO[1:0]	

Pop-Up Messages

Under certain conditions, the software pops up an error message to indicate to the user that an error just happened. Another possible pop-up message shows up when the user

tries to write to the Default Configuration (DCFG) address. This section explains all the possible pop-up messages.

A BREAK IS RECEIVED

The ISL9206 sends a 'break' signal to the host when any error happens. When the interface receives a 'break' signal, it notices the PC software to pop-up the "A break is received" message, as shown in Figure 3. Usually when a 'break' signal is received, the host needs try to read the status register to find the type of error as well as to clear the error.

READ REGISTER FAILED

When the host tries to read a register in the ISL9206 and did not receive the correct data within a time limit, the host pops up the "Read register failed" message, as shown in Figure 4.

WRITE TO USB BUS FAILED

The message in Figure 5 shows up when the PC fails to communicate with the USB device (the interface board).

WRITE CONFIRMATION

Writing to the default configuration address can potentially change the device address, XSD bus speed, interrupt and auto-sleep configuration, or lockout the secret addresses. In order to prevent the user change the default configuration by accident, the software pops up the message shown in Figure 6 to ask for confirmation. The DCFG value will be changed when the user clicks Yes.

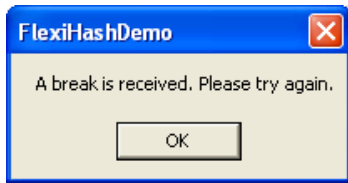

FIGURE 3. "A BREAK IS RECEIVED" POP-UP MESSAGE

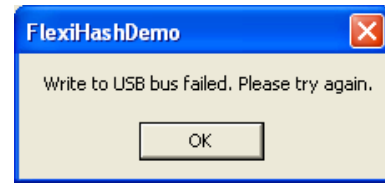

FIGURE 5. "WRITE TO USB BUS FAILED" POP-UP MESSAGE

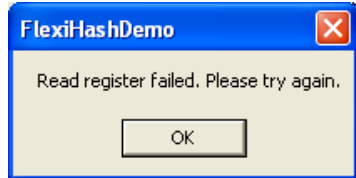

FIGURE 4. "READ REGISTER FAILED" POP-UP MESSAGE

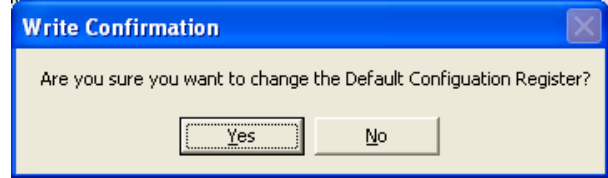

FIGURE 6. "WRITE CONFIRMATION" POP-UP MESSAGE

Authentication Tab

The authentication process takes four steps and this tab allows the user to easily move through the four steps.

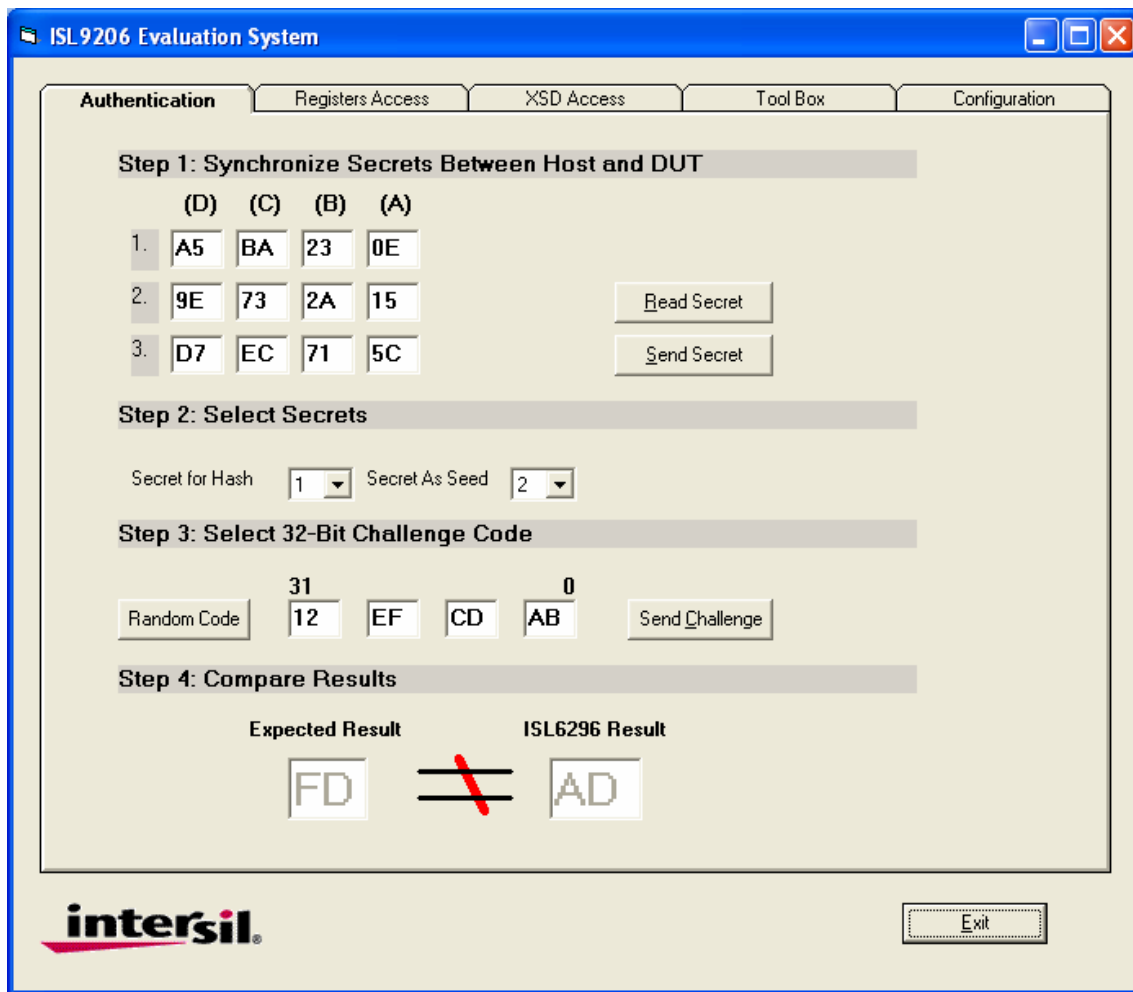

FIGURE 7. SCREEN SHOT OF THE AUTHENTICATION TAB

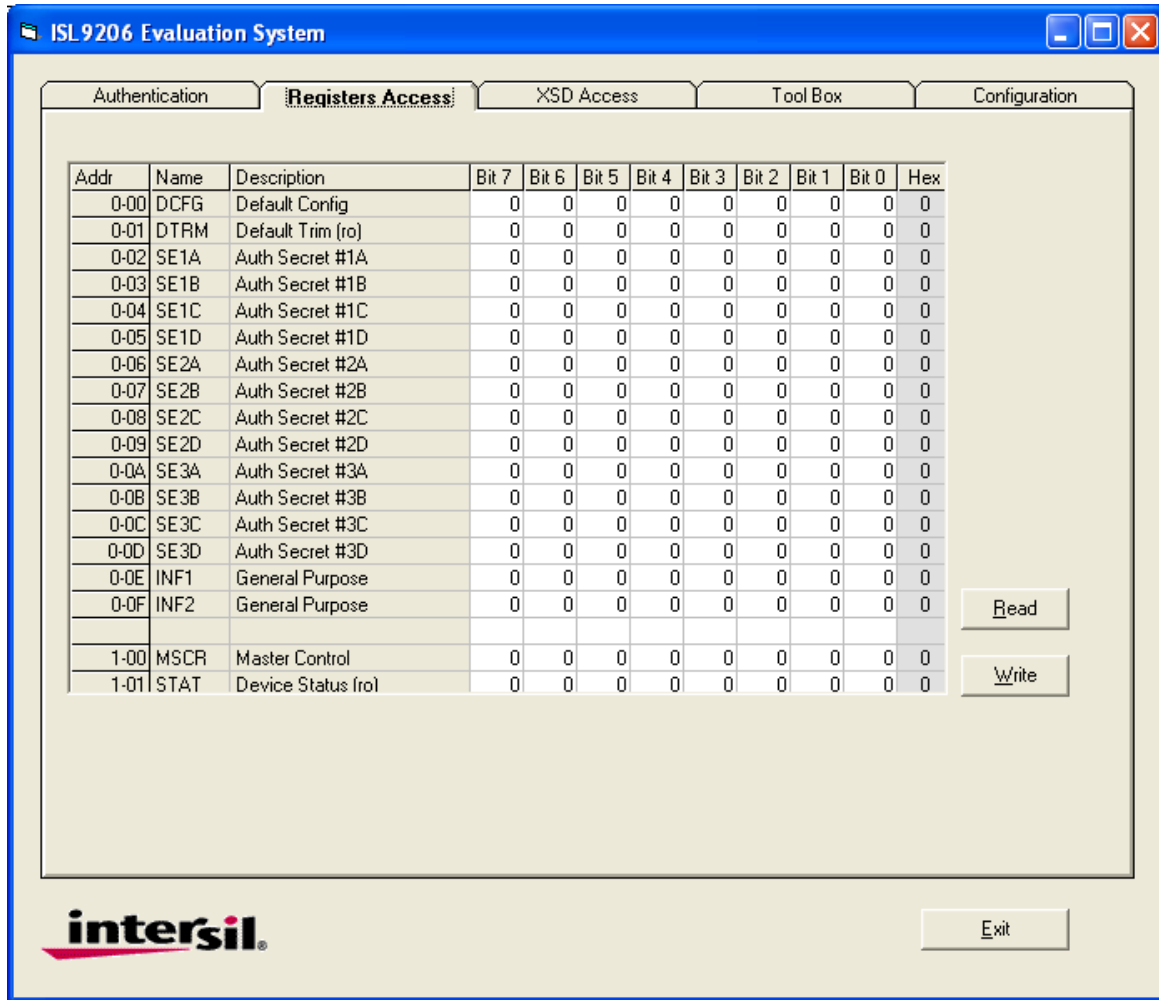

FIGURE 8. SCREEN SHOT OF THE REGISTERS ACCESS TAB

STEP 1: SYNCHRONIZATION OF THE SECRETS

The authentication process requires the same secret be stored in the host and the device. When a challenge is sent, both the host and the device calculate the results based on the same secret and challenge. The results will not match if the secrets in the host and the device do not match.

The secret can be synchronized either by reading the secret from the device or send the secret on the host screen to the device by clicking the *Read Secret* and the *Send Secret* buttons. This tab allows the user to read the secrets from the device (if they are not locked out) or to manually edit the secrets and send them to the device. The secrets are displayed in hexadecimal format. If the secrets in the device are locked out, the host will not be able to read or send the secret.

STEP 2: SELECTION OF THE SECRETS

The ISL9206 has space for three sets of secrets and the authentication algorithm uses one for the Hash engine and one as the seed for the CRC calculator. The second step

requires the user to select the secret for each function respectively.

STEP 2: SENDING CHALLENGE

This step sends the 32-bit challenge to the device. The host will first send the secret selection to the device to ensure that the correct seed is re-loaded before the calculation, and then the displayed challenge code is sent. The user can manually edit the challenge code. The *Random Code* button is for easy random challenge code generation. The challenge code is also displayed in hexadecimal format.

STEP 4: RESULT COMPARISON

Once the challenge code is sent, the PC reads back the hash result from the result register (AUTH). The software has a powerful FlexiHash™ engine built in. The *Expected Result* cell always displays the expected result instantly based on the information on the screen. The result read from the ISL9206 is displayed next to the expected result for easy comparison.

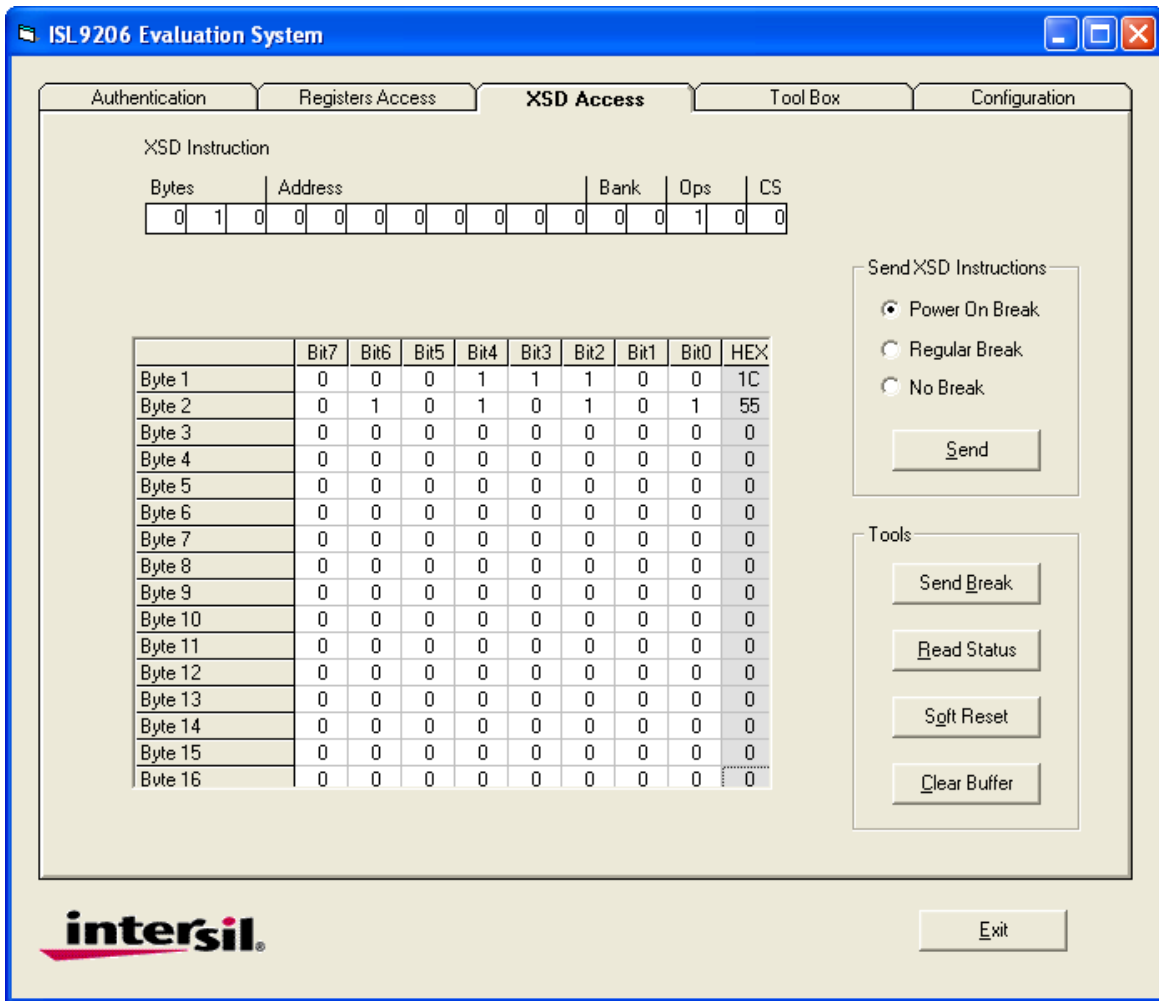

FIGURE 9. SCREEN SHOT OF THE XSD ACCESS TAB

Registers Access Tab

This tab allows the user to read or write to the EEPROM in bank 0, the master control register (MSCR), and the status register (STAT). The default trim (DTRM) byte and the STAT are read-only addresses and are marked with "(ro)". The data are displayed in both binary and hexadecimal forms. To change the value in these addresses, the user can either input in the binary fields or the hexadecimal fields. When the *Read* button is clicked, the host reads all the addresses and updates the results on this tab. When the *Write* button is clicked, the host only sends data to the addresses whose values have been changed. Whenever the user tries to update the DCFG address, the message shown in Figure 6 will pop up to ask for confirmation.

XSD Access Tab

The XSD Access tab is the most powerful tool for evaluating the ISL9206 and requires a good understanding of the ISL9206 in order to use this tool. This tab allows the user to send any XSD instructions to the ISL9206. The 16-bit XSD instruction frame is displayed in the same format as the one given in the datasheet.

The tool also provides a 16-byte table for the XSD data frame. If the instruction is a *Write* instruction, the data that follows the instruction frame should be listed in the table, starting from Byte 1. Byte 1 is the first byte being sent after the instruction frame, followed by Byte 2, and so on. The user can either use the binary fields or the hexadecimal fields for entering the data. When both the instruction and the data are ready, the user can click the *Send* button to send the instruction. If the instruction is a *Read* frame, the data read are listed in the table as well. The first received byte is listed in Byte 1, the second byte is listed in Byte 2, and so on.

There are three options to choose when sending the instructions frame, with "power on break", with "regular break", or "no break". The power-on break is a narrow break that should be used only when the user knows for sure that the device is in the sleep mode. After the narrow break, the device will wake up and send back a break (Refer to the datasheet for more explanation of the narrow power-on break). Figure 14 illustrates the captured waveforms. If the user does not know if the device is in the sleep mode or is

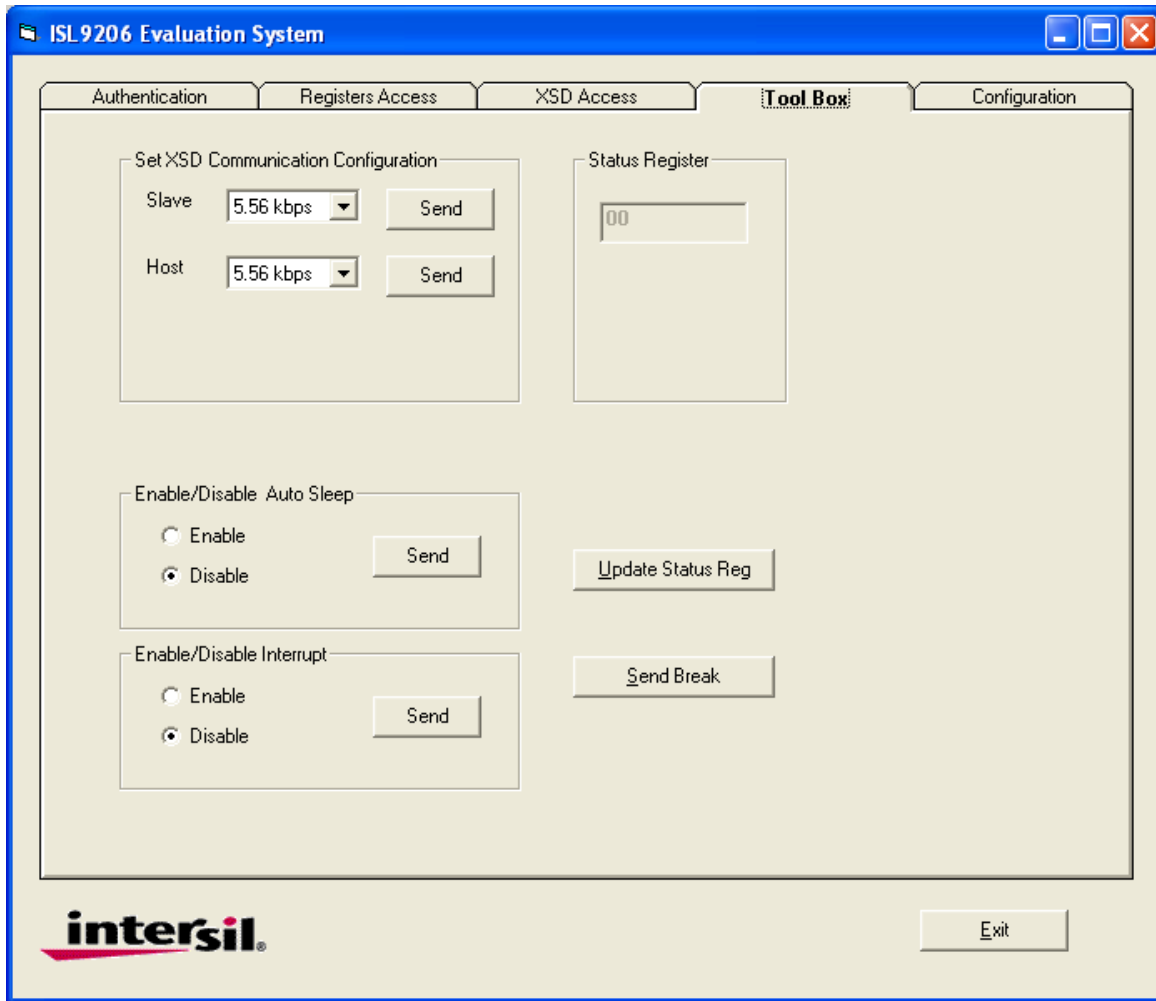

FIGURE 10. SCREEN SHOT OF THE TOOL BOX TAB

awake, the “regular break” option should be chosen, because the long break signal will still wake up a device in sleep mode, or will be ignored if the device is already awake. The send without a break signal can be an option if the user knows for sure that the device is not in the sleep mode.

This tab also offers a few other tools for the convenience of the evaluation. The *Send Break* button sends out a long break when being clicked, allowing the user to reset the XSD bus. The *Read Status* button reads the status register (STAT) into Byte 1 of the table. When a bus error happens, the STAT register needs to be read to clear the error; otherwise, any access to the XSD bus will result in a break signal from the ISL9206. The *Soft Reset* button sets the SRST bit in the master control register (MSCR) to soft-reset the ISL9206. The above two tools can also be implemented using the XSD instructions but is more convenient using these buttons.

Tool Box Tab

This tab is self-explanatory. The most useful tool in this tab is the Set XSD Communication Configuration tool that allows the user to set the host and the slave speeds. The other useful tool is the Enable/Disable Auto Sleep tool.

Configuration Tab

This tab allows the user to adjust the XSD bus voltage. Eventually, this tab will also allow the user to download new firmware to the interface board for upgrading. The latter function is not implemented at this moment.

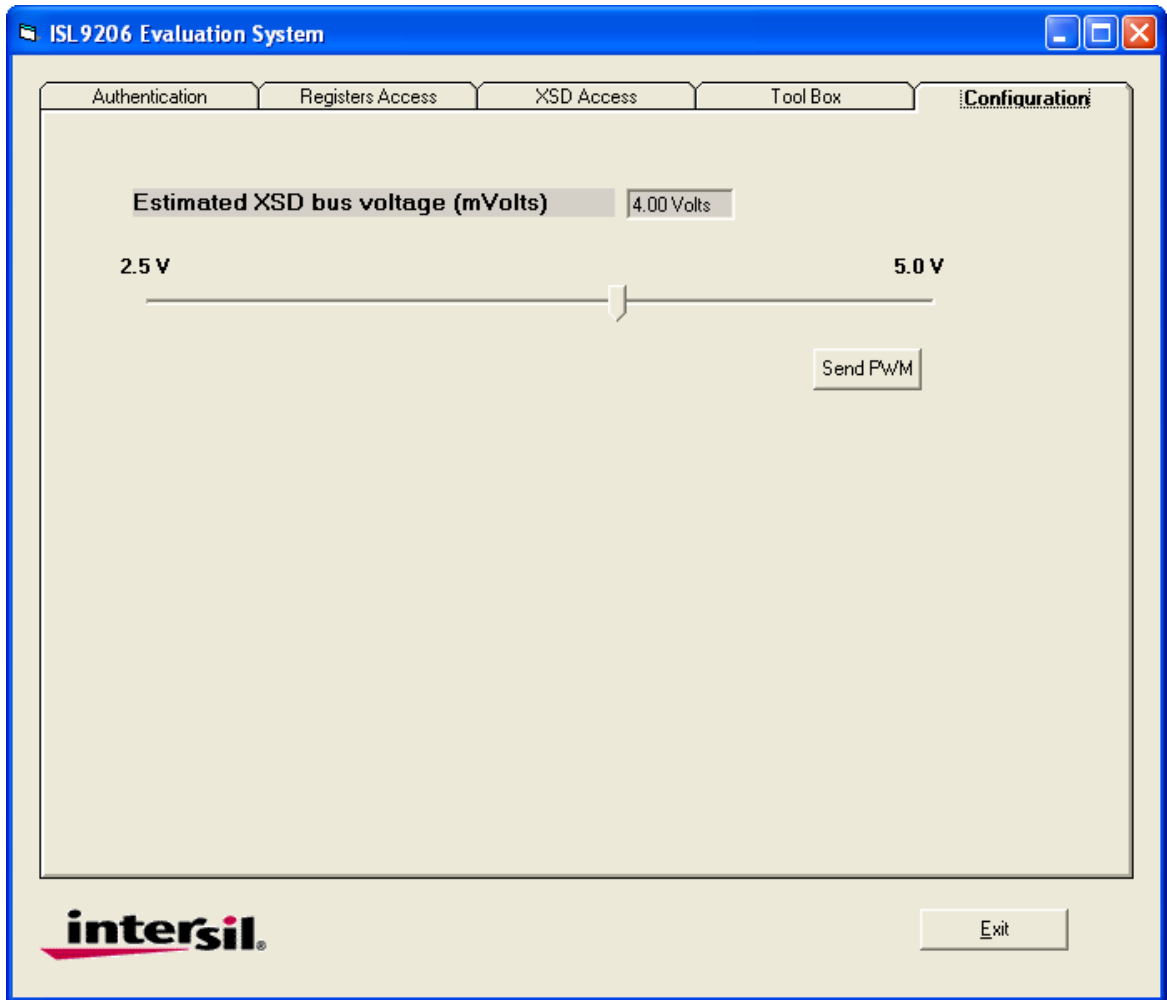

FIGURE 11. SCREEN SHOT OF THE CONFIGURATION TAB

Evaluation Waveforms

The digital signals transferred over the XSD bus can be verified with the help of an oscilloscope. The XSD bus has three digital signals, logic '1', logic '0' and 'break'. Each bit of the digital signals starts with a falling edge. The logic '1' is represented with a signal whose rising edge occurs at approximately 30% of the bit time (BT). The logic '0' has a rising edge occurring at about 70% of BT. A 'break' signal is one whose rising edge happens after 1BT.

Bit '1' and Bit '0'

Figure 12 shows the waveforms for the XSD bus during a transaction. The lower half is a zoomed-in view of the portion of the upper waveform inside the rectangular dash-line box and illustrates how the XSD signal is implemented. The first bit being sent out is the least-significant bit (LSB) of a byte. Figure 12 was captured when the XSD bus was reading 4 bytes of data from the ISL9206 EEPROM. The "A" section of the upper waveform is the 16-bit instruction frame. The "B" section is the 4 bytes from the ISL9206. From the waveform, one can tell that the chip selection field CS = '0', the

OPCODE = '01', the address bank BANK = '00' (EEPROM), and the address = '...01010'. The total byte number is out of the zoomed-in window but it was '100' (4 bytes).

A Complete XSD Transaction

Figure 13 demonstrates a complete XSD transaction of reading the MSCR and STAT registers. The instruction frame for reading these two registers are given in Table 2. Starting from LSB, the instruction frame is: '0, 10, 10, 0000, 0000, 010'. This matches the signals from the scope. Also from the scope waveform, the MSCR and STAT are found out to be, starting from LSB, '0000, 0011', and '0000, 0000' respectively (see Figure 13). Using the XSD Access Tab in the software, the MSCR will be filled into Byte 1 of the table and STAT will be filled into Byte 2. From the MSCR register, one can tell that the Autosleep (ASLP) bit is '0', meaning the auto-sleep mode is turned off.

TABLE 2. INSTRUCTION FRAME FOR READING MSCR AND STAT

BYTE	ADDRESS	BANK	OPCODE	CS
0 1 0	0000,0000	0 1	0 1	0

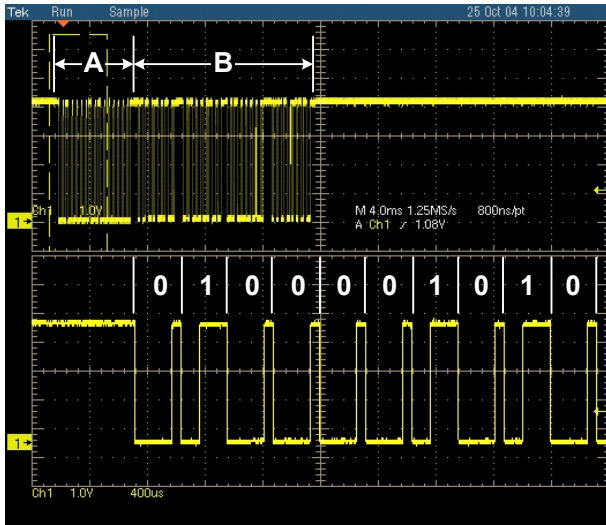

FIGURE 12. CAPTURED SCOPE WAVEFORMS TO SHOW ‘1’ AND ‘0’ OF XSD BUS SIGNALS. A FALLING EDGE SETS THE START OF A BIT TIME AND THE TIMING OF THE RISING EDGE DETERMINES THE BIT VALUE

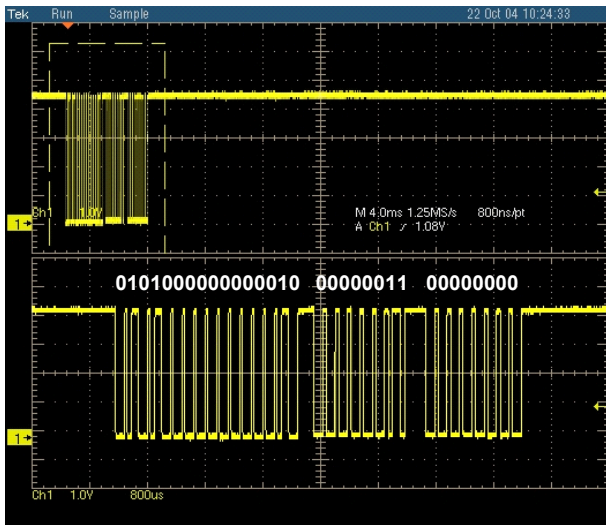

FIGURE 13. CAPTURED SCOPE WAVEFORMS WHEN READING THE MSCR AND STAT REGISTERS

Power-on Break

When the ISL9206 is in sleep mode, the host needs to send a ‘break’ signal to wake up the ISL9206. A ‘break’ signal is a pulse wider than 1BT. When coming out of the sleep mode, the ISL9206 sends a ‘break’ as well. The two ‘break’ signals overlap with each other (merged) and appear to be one pulse. The ‘break’ signal from the ISL9206 is 1.391BT wide, therefore, contains the information for the XSD bus speed (= 1/BT) in the ISL9206. In order to see the ‘break’ signal from the ISL9206, a special narrow ‘break’ (power-on break) signal is provided in the XSD Access tab as an option of the Send button. When this option is selected, the host sends

out a ‘power-on break’ before sending the instruction frame. Figure 14 illustrate the two ‘break’ signals. The narrow one was sent by the host and the wider one was the one returned from the ISL9206 (approximately 480ms). From the 480ms ‘break’ signal, the BT can be calculated as

$$BT = 480ms / 1.391 = 345 \text{ ms}$$

or baud rate is

$$\text{Baud Rate} = 1/BT = 2.90 \text{ kbps}$$

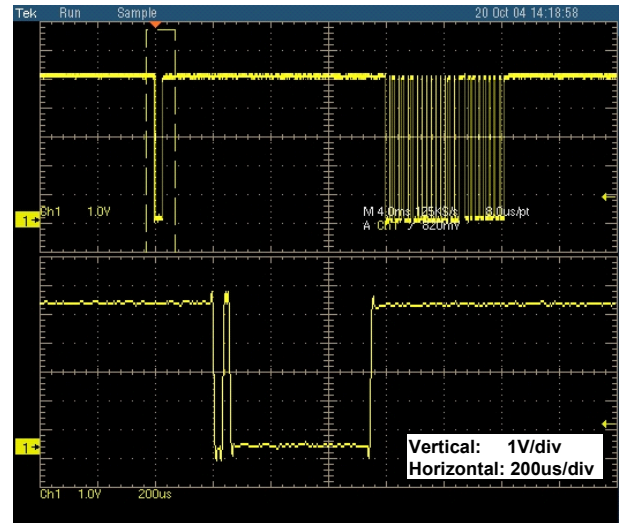

FIGURE 14. POWER-ON BREAK SIGNAL TO WAKE-UP THE ISL9206 FROM SLEEP MODE

Error ‘Break’

When an error occurs during the XSD transaction, a ‘break’ signal is sent by the ISL9206. Figure 15 shows the waveform. A message, as shown in Figure 3, pops up in this case.

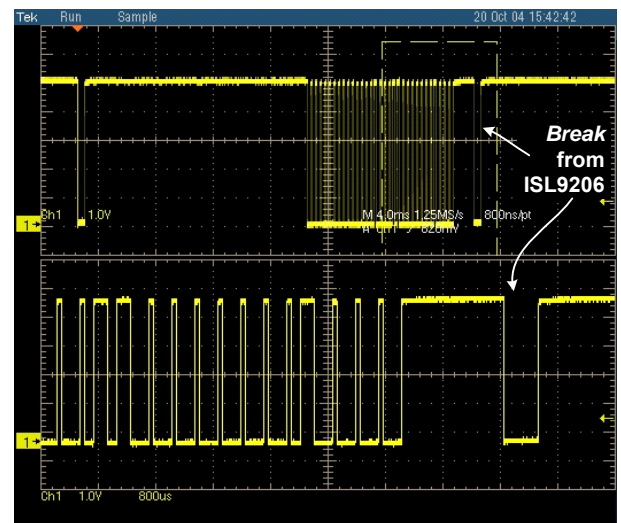

FIGURE 15. ‘BREAK’ SIGNAL SENT BY ISL9206 DUE TO A BUS TRANSACTION ERROR

Summary

The ISL9206 Evaluation Kit provides a convenient platform for users to evaluate the ISL9206. The Authentication Tab demonstrates the authentication process and provides a powerful FlexiHash™ calculator. The Register Access tab allows the user to read from or write to the memories easily. The XSD Access tab provides the tool for evaluating every aspect of the ISL9206. The Tool Box and the Configuration tabs provide other tools such as changing the XSD bus speed or adjust the XSD bus voltage. Most tools, except for the XSD access tool, addresses to device '0'. Users need to change the device address to '0' with the XSD Access tool, if the original address is not '0'. Using an oscilloscope can always monitor the activity on the XSD bus.

Appendix A:

Steps to confirm the Interface Board in the OS after being inserted to the USB port:

1. Right click the "My Computer" icon in the desktop and select "Manage," as shown in Figure 16.
2. Select the Device Manager and the Human Interface Devices folder will lead to the window in Figure 17.
3. Double click the USB Human Interface Device, then Figure 18 will show up.

In Figure 18, one can find "Location: EvaluationKit ISL6296 ...". This is the confirmation that the interface board is properly recognized by the operating system.

The figures are captured in the Win2000 and are very similar in other versions of Microsoft Windows operating Systems.

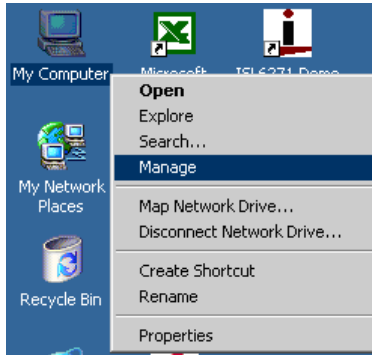

FIGURE 16. SCREEN SHOT OF WHEN RIGHT-CLICKING THE MY COMPUTER ICON ON THE DESKTOP

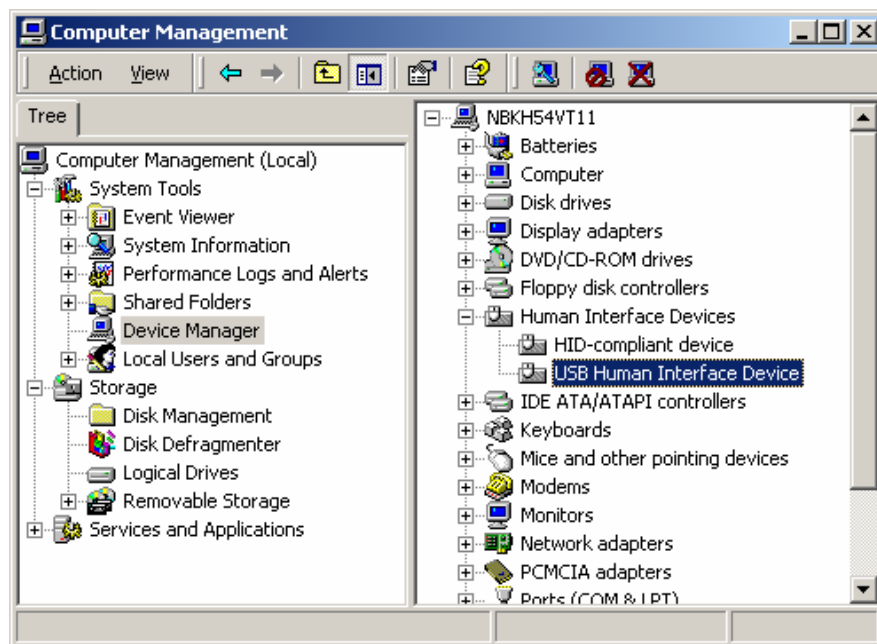

FIGURE 17. SCREEN SHOT OF THE COMPUTER MANAGEMENT FOLDER

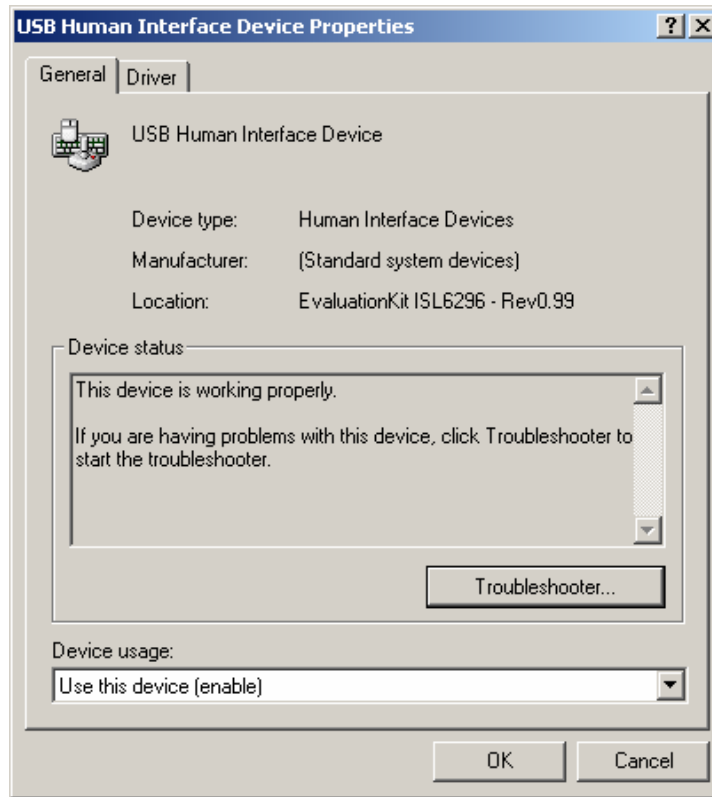

FIGURE 18. SCREEN SHOT OF THE USB HID PROPERTIES WINDOW

Appendix B: ISL9206EVAL1 Board

Figure 19 shows the schematic and Table 3 shows the BOM. Figure 20 is the layout of the silk screen and the top layer.

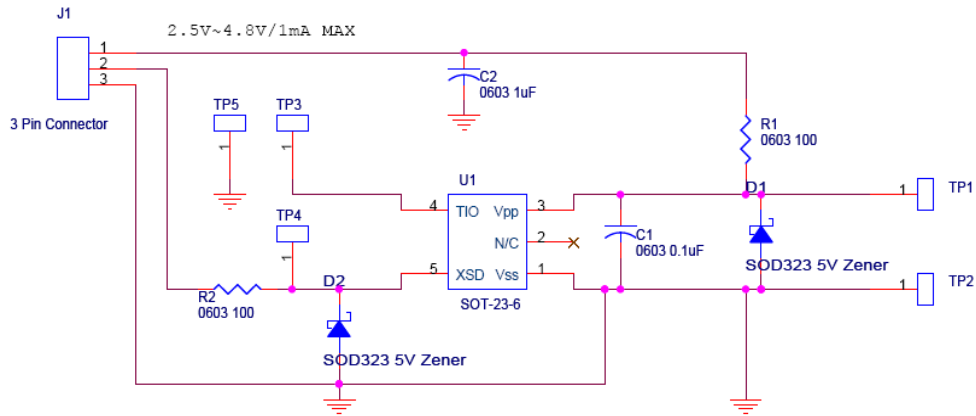

FIGURE 19. SCHEMATIC OF THE EVALUATION BOARD

TABLE 3. BOM FOR THE EVALUATION BOARD

ITEM #	QTY	PART REFERENCE	DESCRIPTION	PART NUMBER	PACKAGE
1	1	C1	0.1μF, 16V, X7R ceramic cap	0603B104K160	0603
2	1	C2	1μF, 6.3V, X5R ceramic cap	0603X105K6R3	0603
3	2	D1, D2	Zener diode, 5.1V	CMDZ5231B	SOD-323
4	1	J1	Single Right Angle 3 Pin Header	WM1754-ND	
5	2	R1, R2	100W, 5%		0603
6	5	TP1, TP2, TP3, TP4, TP5	Miniature Surface Mount Test Point	5015KCT-ND	
7	1	U1	SOT-23, ISL9206	ISL9206	SOT-23

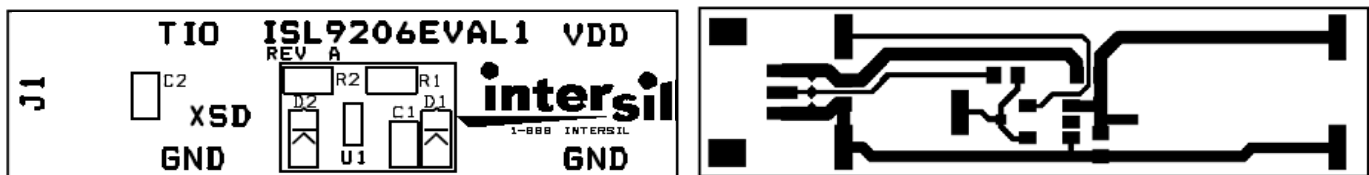

FIGURE 20. LAYOUT OF THE EVALUATION BOARD (SILK SCREEN AND TOP LAYER). THE BOARD DIMENSIONS ARE 1CM X 4CM

Appendix C: Interface Board

The function of the interface board is to translate the PC commands to the XSD commands via the USB port. The schematic for the interface board is shown in Figure 21. The layout and the BOM are given in Figure 22 and Table 4 respectively.

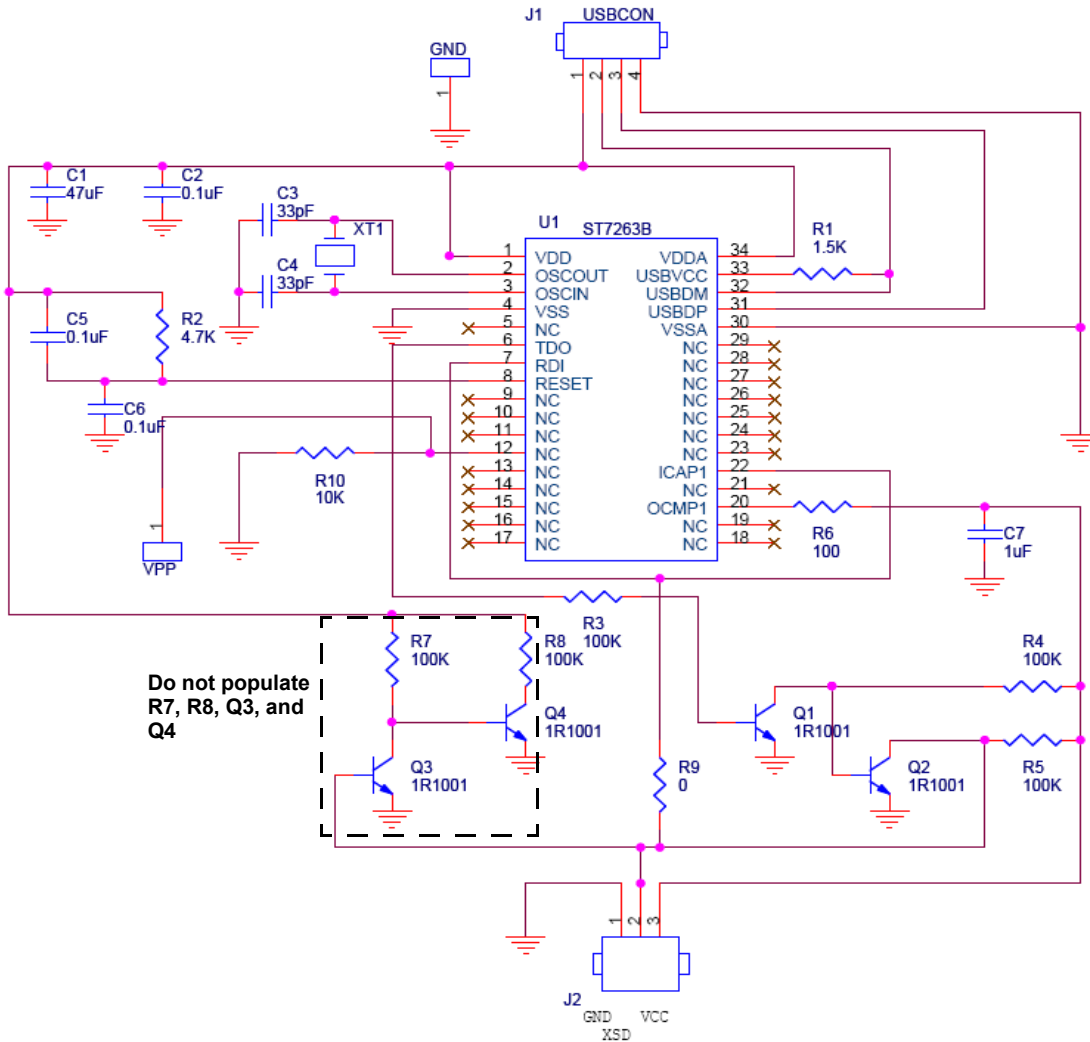

FIGURE 21. SCHEMATIC OF THE USB-TO-XSD INTERFACE BOARD

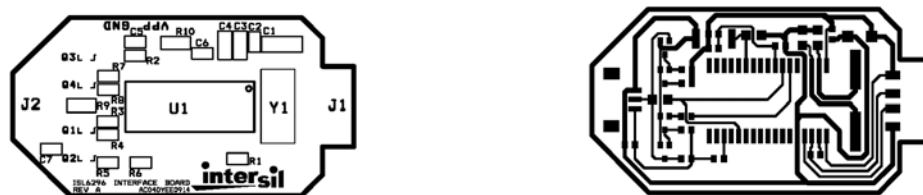

FIGURE 22. LAYOUT OF THE USB-TO-XSD INTERFACE BOARD

TABLE 4. BOM OF THE USB-TO-XSD INTERFACE BOARD

ITEM #	QTY	REFERENCE	DESCRIPTION	PART #	PACKAGE	VENDOR
1	1	C1	4.7 μ F, 10V, X7R ceramic cap	1206X475K100	1206	Walsin
2	3	C2, C5, C6	0.1 μ F, 16V, X7R ceramic cap	0603B104K160	0603	Walsin
3	2	C3, C4	33pF, 50V, NPO ceramic cap	0805CG330J9BB0	0805	Garrett elec
4	1	C7	1 μ F, 6.3V, X5R ceramic cap	0603X105K6R3	0603	Walsin
5	1	R1	1.5k resistor		0603	Various
6	1	R2	4.7k resistor		0603	Various
7	4	R3, R4, R7, R8 (Note)	50k		0603	Various
8	1	R5	5k		0603	Various
9	1	R6	100W		0603	Various
10	1	R9	0W		0805	Various
11	1	R10	10k		0805	Various
12	1	XT1	24MHz, 18pF Crystal Oscillator	300-6145-1-ND		Digikey
13	4	Q1, Q2, Q3, Q4 (Note)	General purpose NPN transistor	CMST3904	SOT-323	Central
14	1	U1	Microcontroller	ST72F63BK4M1	SO-34	ST
15	1	USBCON	USB connector			
16	1	J1	Single Right Angle 3 Pin Header	WM1754-ND		Digikey
17	2	TP1 (VPP), TP2 (GND)	SMD test point	5015KCT-ND		Digikey

NOTE: Do not populate R7, R8, Q3, and Q4.

Appendix D: Techniques to Make Host and ISL9206 Communicate Properly

This appendix describes ways to make the host and the device talk properly, if there is trouble.

1. If the device is in the sleep mode, send a 'power on break' with a read instruction in the XSD Access tab to measure the returned 'break' signal for ISL9206, as shown in Figure 14.
2. Use the method shown in page 8 to calculate the bus speed and then choose the closest host speed using the Tool Box tab.
3. Read the status register using address '0', if no status is returned, then,
4. Try to read the status register using address '1' to confirm the device address is indeed '1'.

If sending a 'power on break' does not lead to a 'break' from the device, then the device is awake. The user needs to try all eight combinations (4 speeds and 2 device addresses) to establish the proper communication.