

## ISL9214A

Li-ion/Li-Polymer Battery Charger Accepting Two Power Sources

FN6698  
Rev 0.00  
May 5, 2008

The ISL9214A is a fully integrated low-cost single-cell Li-ion or Li-polymer battery charger. The charger accepts two power inputs, normally one from a USB (Universal Serial Bus) port and the other from a desktop cradle. The ISL9214A is an ideal charger for smart handheld devices that need to communicate with a personal computer via USB.

The ISL9214A features 28V maximum voltages for both the cradle and the USB inputs. Due to the 28V rated inputs, low-cost, large output tolerance adapters can be used safely. When both inputs are powered, the cradle input is used to charge the battery. The charge current is programmable for the cradle input with a small resistor. The end-of-charge current is also programmable by another external resistor. The charger incorporates Thermaguard™ which protects the IC against over-temperature. If the die temperature rises above a typical value of +125°C, a thermal foldback function reduces the charge current automatically to prevent further temperature rise. The charger has two indication pins. The  $\overline{\text{PPR}}$  (power present) pin outputs an open-drain logic LOW when either the cradle or the USB input power is attached. The  $\overline{\text{CHG}}$  (charge) pin is also an open-drain output that indicates a logic LOW when the charge current is above a minimum current level. When the charge current is below the preset minimum current, the  $\overline{\text{CHG}}$  pin will indicate a logic HIGH signal. This status is latched and will be reset under one of the following events:

1. The part is disabled and re-enabled
2. The selected input source has been removed and re-applied
3. The USBON turns LOW
4. The BAT pin voltage falls below the recharge threshold (~3.9V).

### Ordering Information

PART NUMBER (Note)	PART MARKING	TEMP. RANGE (°C)	PACKAGE (Pb-Free)	PKG. DWG. #
ISL9214AIRZ*	214A	-40 to +85	10 Ld 3x3 DFN	L10.3x3C

\*Add "-T" suffix for tape and reel. Please refer to TB347 for details on reel specifications.

NOTE: These Intersil Pb-free plastic packaged products employ special Pb-free material sets; molding compounds/die attach materials and 100% matte tin plate PLUS ANNEAL - e3 termination finish, which is RoHS compliant and compatible with both SnPb and Pb-free soldering operations. Intersil Pb-free products are MSL classified at Pb-free peak reflow temperatures that meet or exceed the Pb-free requirements of IPC/JEDEC J STD-020.

### Features

- Complete Charger for Single-Cell Li-ion/Polymer Batteries
- **Dual Input Power Sources for Cradle and USB**
- **Low Component Count**
- Integrated Pass Elements
- Fixed 380mA USB Charge Current
- Programmable Cradle Charge Current
- **Charge Current Thermaguard™ for Thermal Protection**
- **28V Maximum Voltages for Cradle and USB Inputs**
- Adapter Presence and Charge Indications
- Less than 0.5µA Leakage Current Off the Battery When No Input Power Attached
- Programmable End-of-Charge Current
- Ambient Temperature Range: -40°C to +85°C
- No External Blocking Diode Required

### Applications

- Smart Handheld Devices
- Cell Phones, PDAs, MP3 Players
- Digital Still Cameras
- Handheld Test Equipment

### Related Literature

- Technical Brief TB363 "Guidelines for Handling and Processing Moisture Sensitive Surface Mount Devices (SMDs)"
- Technical Brief TB389 "PCB Land Pattern Design and Surface Mount Guidelines for QFN Packages"

### Pinout

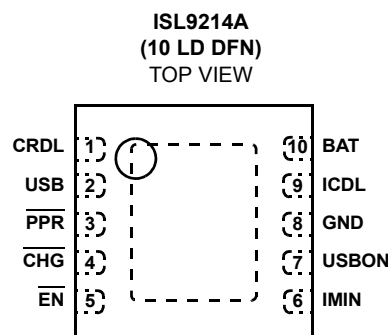



## Typical Applications

### A Simple Charger Accepting Power from Both a USB Port and a Desktop Cradle

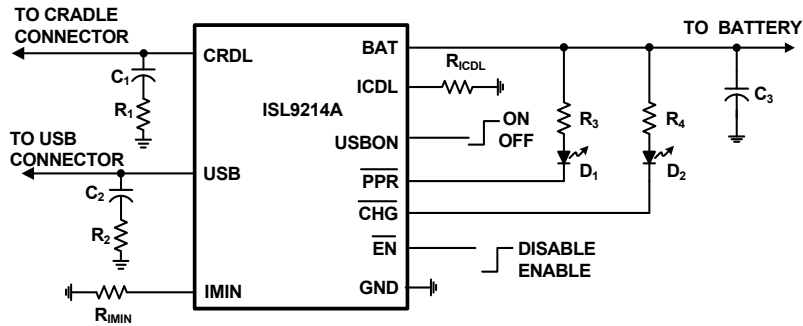

TABLE 1. COMPONENT SELECTION

$R_{ICDL}$	12.4k $\Omega$ for 0.55A cradle charge current
$R_{IMIN}$	10k $\Omega$ for 55mA end-of-charge current
$R_3, R_4$	350 $\Omega$
$C_1, C_2, C_3$	1 $\mu$ F ceramic capacitor
$R_1, R_2$	1 $\Omega$
$D_1, D_2$	LEDs

### A Simple Charger with Programmable Charge Current and Wide Input Voltage Range

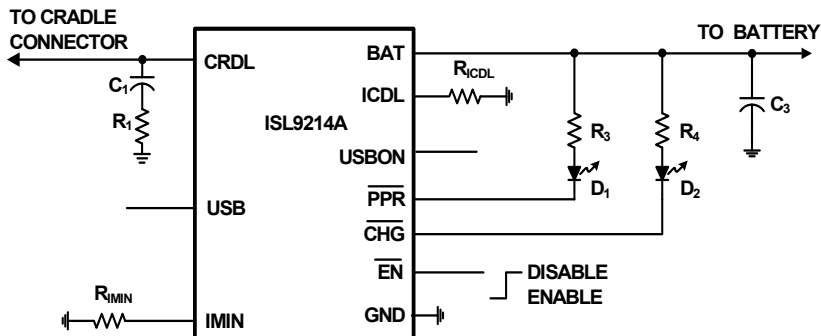

TABLE 2. COMPONENT SELECTION

$R_{ICDL}$	12.4k $\Omega$ for 0.55A cradle charge current
$R_{IMIN}$	10k $\Omega$ for 55mA end-of-charge current
$R_3, R_4$	350 $\Omega$
$C_1, C_3$	1 $\mu$ F ceramic capacitor
$R_1$	1 $\Omega$
$D_1, D_2$	LEDs

**Absolute Maximum Ratings**

Supply Voltage (CRDL, USB) . . . . . -0.3V to 28V  
 Other Input Voltage ( $\overline{EN}$ , USBON, ICDL, IMIN, BAT) . . . -0.3V to 7V  
 Open-Drain Pull-Up Voltage (PPR, CHG) . . . . . -0.3V to 7V

**Recommended Operating Conditions**

Ambient Temperature Range . . . . . -40°C to +85°C  
 Supply Voltage (USB Pin) . . . . . 4.3V to 5.5V  
 Supply Voltage (CRDL Pin) . . . . . 4.3V to 24V  
 Typical Cradle Charge Current . . . . . 100mA to 1A  
 Typical USB Charge Current . . . . . 380mA

**CAUTION:** Do not operate at or near the maximum ratings listed for extended periods of time. Exposure to such conditions may adversely impact product reliability and result in failures not covered by warranty.

**NOTES:**

- $\theta_{JA}$  is measured in free air with the component mounted on a high effective thermal conductivity test board with "direct attach" features. See Tech Brief TB379.
- For  $\theta_{JC}$  the "case temp." location is the center of the exposed metal pad on the package underside.

**Thermal Information**

Thermal Resistance  $\theta_{JA}$  (°C/W)  $\theta_{JC}$  (°C/W)  
 DFN Package (Notes 1, 2) . . . . . 40 2.5  
 Maximum Junction Temperature (Plastic Package) . . . . . +150°C  
 Maximum Storage Temperature Range . . . . . -65°C to +150°C  
 Pb-free reflow profile . . . . . see link below  
<http://www.intersil.com/pbfree/Pb-FreeReflow.asp>

**Electrical Specifications** Typical values are tested at USB = CRDL = 5V and +25°C Ambient Temperature, maximum and minimum values are established over the recommended operating conditions, unless otherwise noted.

PARAMETER	SYMBOL	TEST CONDITIONS	MIN	TYP	MAX	UNITS
<b>POWER-ON RESET</b>						
Rising USB/CRDL Threshold			3.4	3.9	4.2	V
Falling USB/CRDL Threshold			3.15	3.3	3.45	V
<b>VIN-BAT OFFSET VOLTAGE</b>						
Rising Edge	$V_{OS}$	$V_{BAT} = 4.0V$ , use $\overline{CHG}$ pin to indicate the comparator output (Note 3)	-	150	250	mV
Falling Edge	$V_{OS}$		20	80	-	mV
<b>STANDBY CURRENT</b>						
BAT Pin Sink Current	$I_{STANDBY}$	$\overline{EN} = HIGH$ or both inputs are floating	-	0.05	0.5	$\mu A$
CRDL Pin Supply Current	$I_{CRDL}$	$\overline{EN} = HIGH$	-	150	220	$\mu A$
USB Pin Supply Current	$I_{USB}$		-	150	220	$\mu A$
CRDL/USB Pin Supply Current		$\overline{EN} = LOW$ or floating	-	0.55	0.8	mA
<b>VOLTAGE REGULATION</b>						
Output Voltage	$V_{CH}$	Load = 10mA	4.158	4.2	4.242	V
Output Voltage	$V_{CH}$	Load = 10mA ( $T_j = +25^\circ C$ )	4.174	4.2	4.226	V
CRDL PMOS ON-Resistance		$V_{BAT} = 3.8V$ , $I_{CHARGER} = 0.3A$ , ( $T_j = +25^\circ C$ )	200	600	850	$m\Omega$
USB PMOS ON-Resistance		$V_{BAT} = 3.8V$ , $I_{CHARGER} = 0.3A$ , ( $T_j = +25^\circ C$ )	200	600	850	$m\Omega$
<b>CHARGE CURRENT (Note 4)</b>						
ICDL Pin Output Voltage	$V_{ICDL}$	$V_{BAT} = 3.8V$	1.19	1.22	1.25	V
CRDL Input Constant Charge Current	$I_{CHARGE}$	$R_{ICDL} = 12.4k\Omega$ , $V_{BAT}: 2.7V$ to 3.8V	520	550	580	mA
CRDL Input Trickle Charge Current	$I_{TRICKLE}$	$R_{ICDL} = 12.4k\Omega$ , $V_{BAT} = 2.2V$ Given as a % of the CRDL $I_{CHARGE}$	16	18	20	%
CRDL and USB End-of-Charge Threshold	$I_{MIN}$	$R_{IMIN} = 10.0k\Omega$	46.5	55	63.5	mA
USB Input Constant Charge Current	$I_{CHARGE}$	USBON = HIGH, $V_{BAT}: 2.7V$ to 3.8V	332	380	410	mA
USB Input Trickle Charge Current	$I_{TRICKLE}$	$V_{BAT} = 2.2V$	66	80	91	mA
<b>PRECONDITIONING CHARGE THRESHOLD</b>						
Preconditioning Charge Threshold Voltage	$V_{MIN}$		2.5	2.6	2.7	V

**Electrical Specifications** Typical values are tested at USB = CRDL = 5V and +25°C Ambient Temperature, maximum and minimum values are established over the recommended operating conditions, unless otherwise noted. **(Continued)**

PARAMETER	SYMBOL	TEST CONDITIONS	MIN	TYP	MAX	UNITS
<b>RECHARGE THRESHOLD</b>						
Recharge Threshold Voltage	V <sub>RCH</sub>		3.8	3.9	4.0	V
<b>INTERNAL TEMPERATURE MONITORING</b>						
Current Foldback Threshold (Note 5)	T <sub>FOLD</sub>		110	125	140	°C
<b>LOGIC INPUT AND OUTPUT</b>						
USBON Logic Input High			1.3	-	-	V
USBON Logic Input LOW			-	-	0.4	V
$\overline{\text{EN}}$ Pin Logic Input High			1.3	-	-	V
$\overline{\text{EN}}$ Pin Logic Input Low			-	-	0.4	V
$\overline{\text{EN}}$ Pin Internal Pull-Down Resistance			350	600	850	kΩ
USBON Pin internal Pull-Down Resistance			700	1000	1300	kΩ
$\overline{\text{CHG/PPR}}$ Sink Current		Pin Voltage = 0.8V	10	-	-	mA

NOTES:

- The 4.0V V<sub>BAT</sub> is selected so that the  $\overline{\text{CHG}}$  output can be used as the indication for the offset comparator output indication. If the V<sub>BAT</sub> is lower than the POR threshold, no output pin can be used for indication.
- The charge current can be affected by the thermal foldback function if the IC under the test setup cannot dissipate the heat.
- Limits established by characterization and are not production tested.

**Typical Operating Performance**

The test conditions for the Typical Operating Performance are: V<sub>IN</sub> = 5V, T<sub>A</sub> = +25°C, R<sub>ICDL</sub> = 12.4kΩ, R<sub>IMIN</sub> = 10.0kΩ, V<sub>BAT</sub> = 3.7V, Unless Otherwise Noted.

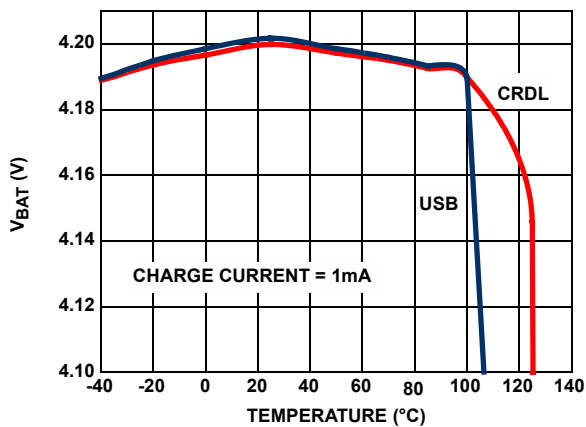

FIGURE 1. CHARGER OUTPUT VOLTAGE vs TEMPERATURE

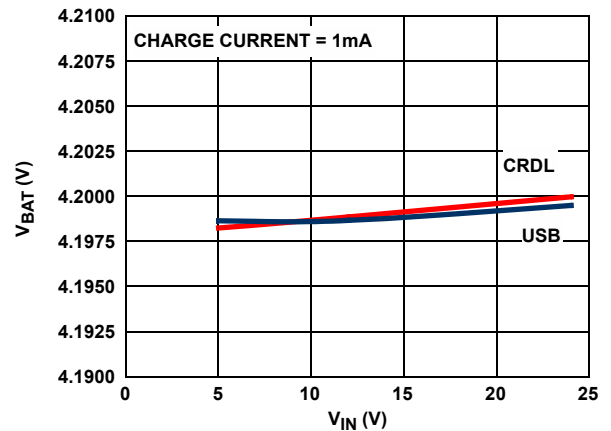

FIGURE 2. CHARGER OUTPUT VOLTAGE vs INPUT VOLTAGE

**Typical Operating Performance**

The test conditions for the Typical Operating Performance are:  $V_{IN} = 5V$ ,  $T_A = +25^\circ C$ ,  $R_{ICDL} = 12.4k\Omega$ ,  $R_{IMIN} = 10.0k\Omega$ ,  $V_{BAT} = 3.7V$ , Unless Otherwise Noted. (Continued)

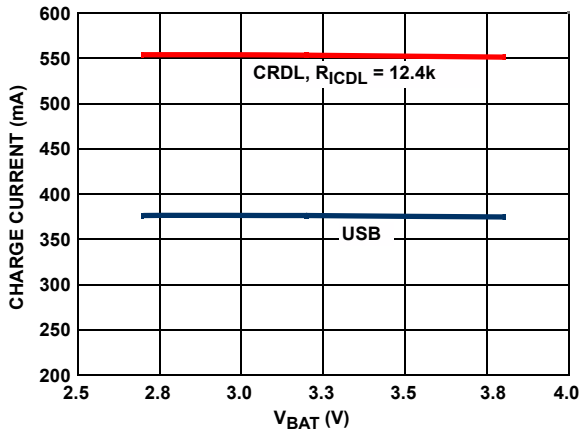

FIGURE 3. CHARGE CURRENT vs OUTPUT VOLTAGE

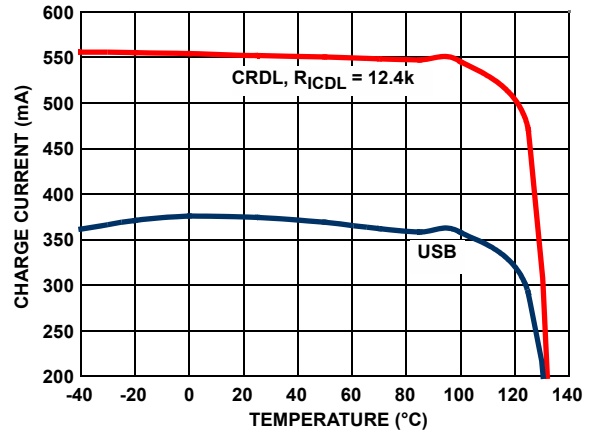

FIGURE 4. CHARGE CURRENT vs AMBIENT TEMPERATURE

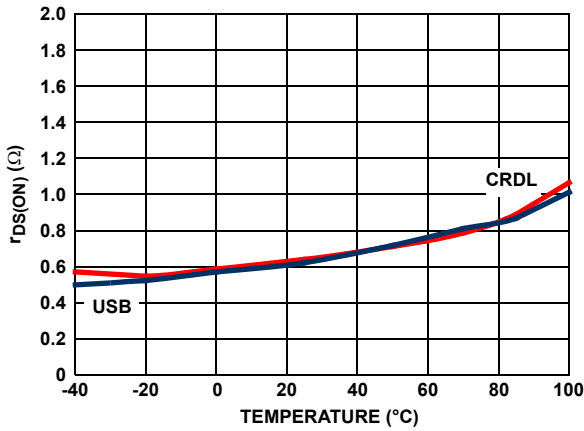

FIGURE 5.  $r_{DS(ON)}$  vs TEMPERATURE AT 3.7V OUTPUT

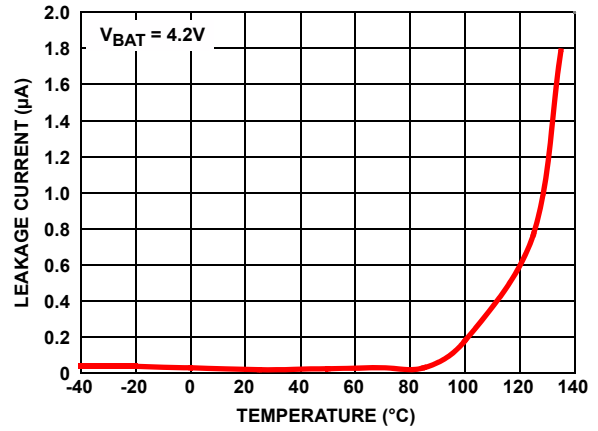

FIGURE 6. REVERSE CURRENT vs TEMPERATURE

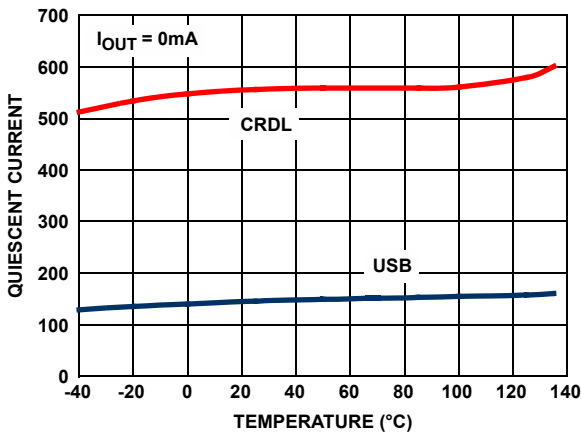

FIGURE 7. CRADLE INPUT QUIESCENT CURRENT vs TEMPERATURE

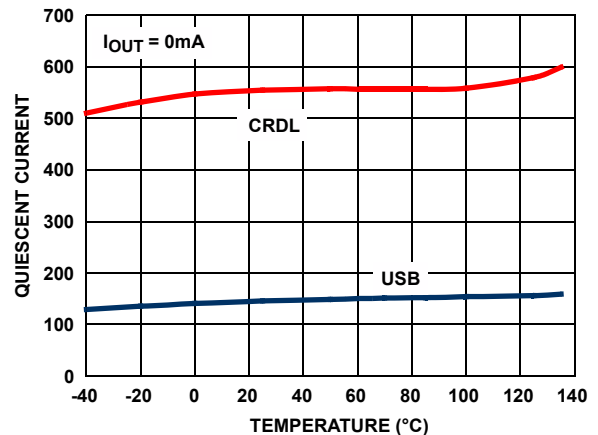

FIGURE 8. USB INPUT QUIESCENT CURRENT vs TEMPERATURE

## Typical Operating Performance

The test conditions for the Typical Operating Performance are:  $V_{IN} = 5V$ ,  $T_A = +25^\circ C$ ,  $R_{ICDL} = 12.4k\Omega$ ,  $R_{IMIN} = 10.0k\Omega$ ,  $V_{BAT} = 3.7V$ , Unless Otherwise Noted. (Continued)

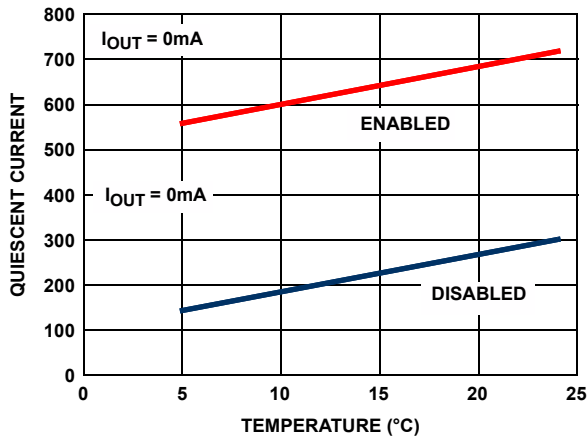

FIGURE 9. CRADLE INPUT QUIESCENT CURRENT vs INPUT VOLTAGE

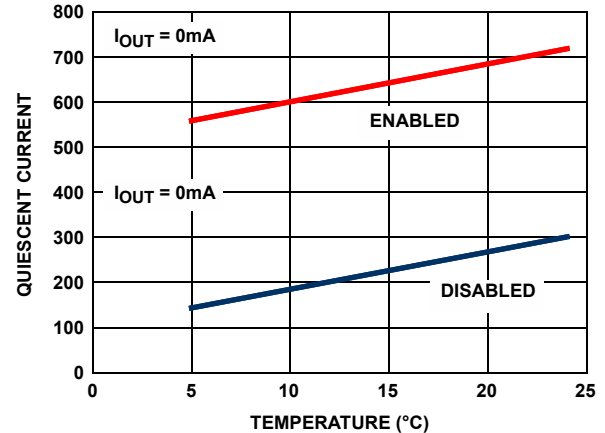

FIGURE 10. USB INPUT QUIESCENT CURRENT vs INPUT VOLTAGE

## Functional Pin Description

### CRDL (Pin 1)

Cradle input. This pin is usually connected to a cradle power input. The maximum input voltage is 28V. The charge current from this pin is programmable with the ICDL pin up to 1A. When this pin is connected to a power source, no charge current is drawn from the USB pin. A  $1\mu F$  or larger value ceramic capacitor is recommended for decoupling.

### USB (Pin 2)

USB input. This pin is usually connected to a USB port power connector and other sources that are also acceptable. The charge current from the USB pin is fixed at typically 380mA. A  $1\mu F$  or larger value ceramic capacitor is recommended for decoupling. It is also recommended to have a  $1\Omega$  resistor in series with the decoupling capacitor to prevent an over-shoot voltage when a USB cable is plugged in.

### PPR (Pin 3)

Power presence indication. An open-drain output pin, which turns ON when either the USB input voltage or the CRDL input voltage is above its POR level, regardless of the charger is enabled or disabled, otherwise it turns OFF. This pin provides a wake-up signal to a microprocessor when either the cradle or the USB power is connected.

### CHG (Pin 4)

Charge indication pin. An open-drain output, which turns ON when the charge current is above programmable threshold, otherwise it turns OFF.

### EN (Pin 5)

Enable logic input. Connect to LOW or leave floating to enable the charger.

### IMIN (Pin 6)

IMIN is the programmable input for the end-of-charge current. IMIN is calculated by using Equation 1:

$$I_{MIN} = \frac{550}{R_{IMIN}} \quad (\text{mA}) \quad (\text{EQ. 1})$$

Where  $R_{IMIN}$  is in  $k\Omega$ . IMIN is applicable for both cradle and USB charging.

### USBON (Pin 7)

The USBON pin is a control input to turn off the USB charge function if desired. Connect to LOW or leave floating to turn off USB charge.

### GND (Pin 8)

System ground.

### ICDL (Pin 9)

The ICDL pin has two functions. The first function is to program the cradle charge current during the constant-current mode. The voltage of this pin is 1.22V during the constant-current mode of the cradle charger. The constant-current mode current is programmed by using Equation 2:

$$I_{CDL} = \frac{6820}{R_{ICDL}} \quad (\text{mA}) \quad (\text{EQ. 2})$$

where  $R_{ICDL}$  is the resistor in  $k\Omega$ , connected to the ICDL pin (see "Typical Applications" on page 3).

It is recommended that the charge current be programmed in the range of 100mA to 1000mA.

The second function of the ICDL pin is to monitor the actual charge current. The voltage of this pin,  $V_{ICDL}$ , is proportional to the actual charge current,  $I_{CHG}$ .

The cradle charge current should be programmed equal or higher than the USB current; otherwise, the ICDL pin voltage will be higher than 1.22V during the constant-current mode when the USB charger is working. The charger still works properly but the accuracy of the current monitoring voltage degrades and saturates at approximately 2.1V.

### BAT (Pin 10)

Charger output pin. Connect this pin to the battery pack or the battery cell. A 1 $\mu$ F or larger value ceramic capacitor is recommended for decoupling. The charger relies on the battery for stability so a battery should always be connected to the BAT pin.

### Description

The ISL9214A is designed for a single-cell Li-ion or Li-polymer battery charging circuit that accepts both a USB port and a desktop cradle as its power source. While the charge-current from the USB input source is fixed at 380mA, the charge current from the cradle input is programmable between 0.1A and 1.0A by the resistor  $R_{ICDL}$ . Similarly, the end-of-charge current is programmable by connecting a resistor at the IMIN pin. The end-of-charge threshold can be calculated with the Equation 1 given in the "Functional Pin Description" on page 7. The same threshold applies to both the cradle and the USB inputs.

### Input Auto Selection

When both input sources are present, the charger selects only one power source to charge the battery. When the CRDL input is higher than the POR threshold, CRDL is selected as the power source, otherwise, the USB input is selected. If the CRDL input voltage is below the battery voltage but the USB input voltage is higher than the battery voltage, then the USB input is used to charge the battery. The control circuit always breaks both internal power devices before switching from one power source to the other to avoid a cross conduction of both power MOSFETs.

### USB Charge Current

When the USB port is selected as the power source, the charge-current is enabled by the logic input at the USBON pin. When the USBON is driven to logic LOW, the charger is disabled. When the USBON is driven to logic HIGH, the charge current is fixed at a typical value of 380mA. Thus, for the USB input, the USBON pin has a similar function as the  $\overline{EN}$  pin. Table 3 describes the USB charge control by both the USBON pin and  $\overline{EN}$  pin:

TABLE 3. USB CHARGE CONTROL

	$\overline{EN} = \text{LOW}$	$\overline{EN} = \text{HIGH}$
USBON = LOW	Disabled	Disabled
USBON = HIGH	Enabled	Disabled

The USBON pin is equivalent to a logic LOW when left floating. Typically, the P-Channel MOSFET for the USB input has an

$r_{DS(ON)}$  of 600m $\Omega$  at room temperature. With a 380mA charge current, the typical head room is 228mV. Thus, if the input voltage drops to a level that the voltage difference between the USB pin and the BAT pin is less than 228mV, the  $r_{DS(ON)}$  becomes a limiting factor of the charge-current; and the charger drops out the constant-current regulation.

### Cradle Charge Current

The cradle charge current is enabled by the  $\overline{EN}$  pin only; the USBON pin has no control on the cradle charge current. The cradle charge current is programmed with the external resistor connected between the ICDL pin and the GND pin. The current can be calculated with Equation 2 given in the ICDL pin description on page 7. The typical  $r_{DS(ON)}$  of the P-Channel MOSFET for the CRDL input is 600m $\Omega$  at room temperature. When the head room between the input and output voltages is small, the actual charge current, similar to the USB case, could be limited by the  $r_{DS(ON)}$ . On the other hand, if the headroom between the input and output voltages is large, the charge current may be limited by the thermal foldback threshold.

### Floating Charge Voltage

The floating voltage during the constant voltage phase is 4.2V. The floating voltage has an 1% accuracy over the ambient temperature range of -40°C to +85°C.

### Trickle Charge Current

When the battery voltage is below the minimum battery voltage  $V_{MIN}$  given in the "Electrical Specification" table on page 4, the charger operates in a trickle/preconditioning mode, where the charge current is typically 18% of the programmed charge current for the cradle input. If power comes from the USB input, the trickle current is approximately 80mA.

### End-Of-Charge Indication

When an EOC condition (charge current falls below  $I_{MIN}$  during constant voltage charge) is encountered, the CHG pin internal open-drain MOSFET turns off. The  $I_{MIN}$  threshold is programmable by the resistor at the IMIN pin for both cradle and USB inputs. Once the EOC condition is reached, the status is latched and can be reset at one of the following conditions:

1. The part is disabled and re-enabled
2. The selected input source has been removed and reapplied
3. The USBON turns LOW and turns back to HIGH for the USB input
4. The BAT pin voltage falls below the recharge threshold (~3.9V)



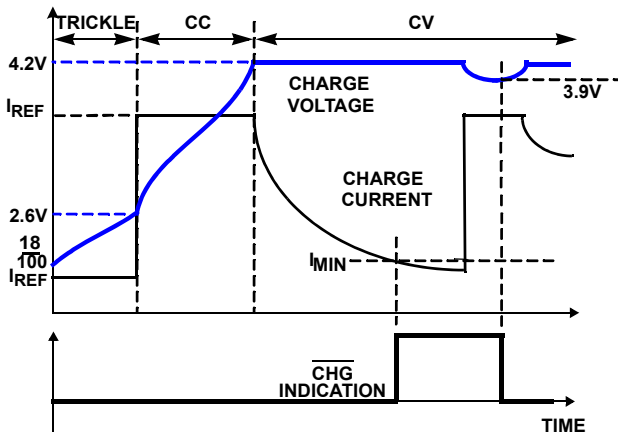

FIGURE 11. TYPICAL CHARGE CYCLE

Figure 11 shows the typical charge profile including the end-of-charge event.

### Power Presence Indication

When either the USB or the cradle input voltage is above the POR threshold, the  $\overline{\text{PPR}}$  pin internal open-drain MOSFET turns on indicating the presence of input power.

### Power-Good Conditions

Even if there is power present, the charger will not deliver any current to the output if the power-good conditions are not met. The following two conditions together define the power-good voltage range:

1.  $V_{\text{CDRL}}$  or  $V_{\text{USB}} > V_{\text{POR}}$
2.  $V_{\text{CDRL}}$  or  $V_{\text{USB}} - V_{\text{BAT}} > V_{\text{OS}}$

where  $V_{\text{POR}}$  is the power-on reset threshold and  $V_{\text{OS}}$  is the offset voltage for the input and output voltage comparator. All of these thresholds have hysteresis, as given in the “Electrical Specification” table on page 4. The charger will not charge the battery if the input voltage does not meet the power-good conditions.

### Thermal Foldback (Thermaguard™)

The thermal foldback function reduces the charge current when the internal temperature reaches the thermal foldback threshold, which is typically  $+125^{\circ}\text{C}$ . This protects the charger from excessive thermal stress at high input voltages.

### Input Bypass Capacitors

Due to the inductance of the power leads of the wall adapter or USB source, the input capacitor type must be properly selected to prevent high voltage transient during a hot-plug event. A tantalum capacitor is a good choice for its high ESR, which provides damping to the voltage transient. Multi-layer ceramic capacitors, however, have a very low ESR, and hence, when chosen as input capacitors, a  $1\Omega$  series resistor must be used (as shown in the “Typical Applications” on page 3) in order to provide adequate damping.

### State Diagram

The state diagram for the charger functions is shown in Figure 12. The diagram starts with the Power-Off state. When at least one input voltage rises above the POR threshold, the charge resets itself. If both input voltages are above the POR threshold, the charger selects the CRDL input as the power source. Then, if the  $\overline{\text{EN}}$  pin is at a logic HIGH voltage, the charger stays in disabled state. If the  $\overline{\text{EN}}$  pin goes LOW, the fast charge starts. Any time the  $\overline{\text{EN}}$  pin turns HIGH, the charger returns to the disabled state. When the EOC condition is reached, the  $\overline{\text{CHG}}$  will turn to logic HIGH to indicate a charge complete status but the charge will continue. The EOC condition is then latched until one of the four re-charge conditions is encountered, as shown in Figure 11.

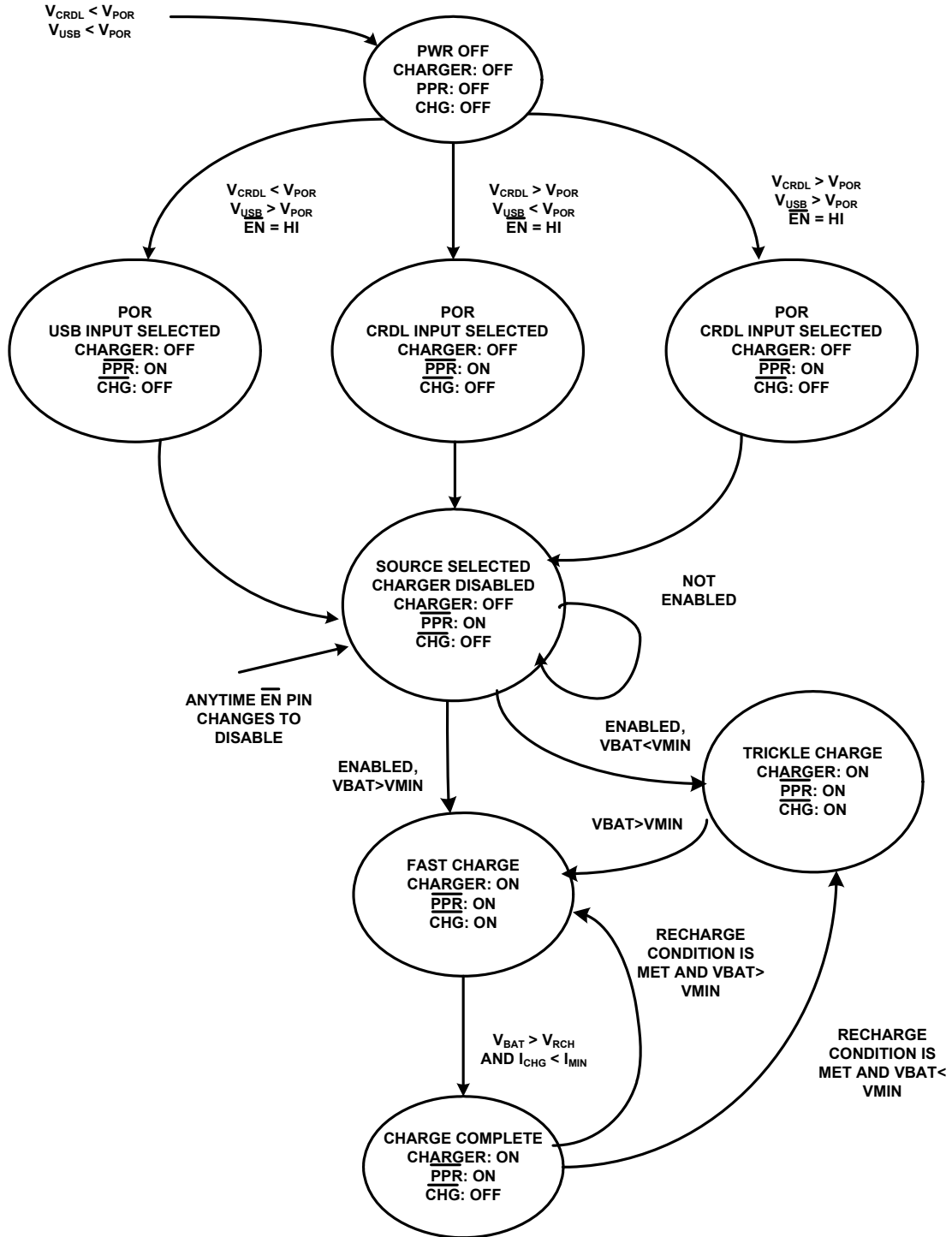

FIGURE 12. STATE DIAGRAM