

ISL9440AEVAL1Z

Triple PWM Step-Down Synchronous Buck Controller and One LDO Evaluation Board

AN1551  
Rev 0.00  
Mar 5, 2010

ISL9440AEVAL1Z Evaluation Board

The ISL9440AEVAL1Z evaluation board features the ISL9440A. The ISL9440A is a quad-output controller that integrates three PWM synchronous buck controllers and one low-dropout linear regulator controller. The ISL9440A offers internal soft-start, independent enable functions and integrates UV/OV/OC/OT protection. Its current mode control architecture and internal compensation network keep peripheral component count minimal. Switching frequency of 600kHz minimizes inductor size while the strong gate drivers deliver up to 12A to each PWM channel.

Table 1 shows the difference in terms of ISL944xx family features.

TABLE 1. FEATURES OF ISL944xx FAMILY

PART NUMBER	EARLY WARNING	SWITCHING FREQUENCY (kHz)	SOFT-STARTING TIME (ms)
ISL9440	Yes	300	1.7
ISL9440A	Yes	600	1.7
ISL9441	No	300	1.7
ISL9440B	Yes	300	Programmable
ISL9440C	Yes	600	Programmable

The ISL9440AEVAL1Z is easy to set up to evaluate the performance of the ISL9440A. Please refer to the "Electrical Specifications" table on page 2 for typical performance summary.

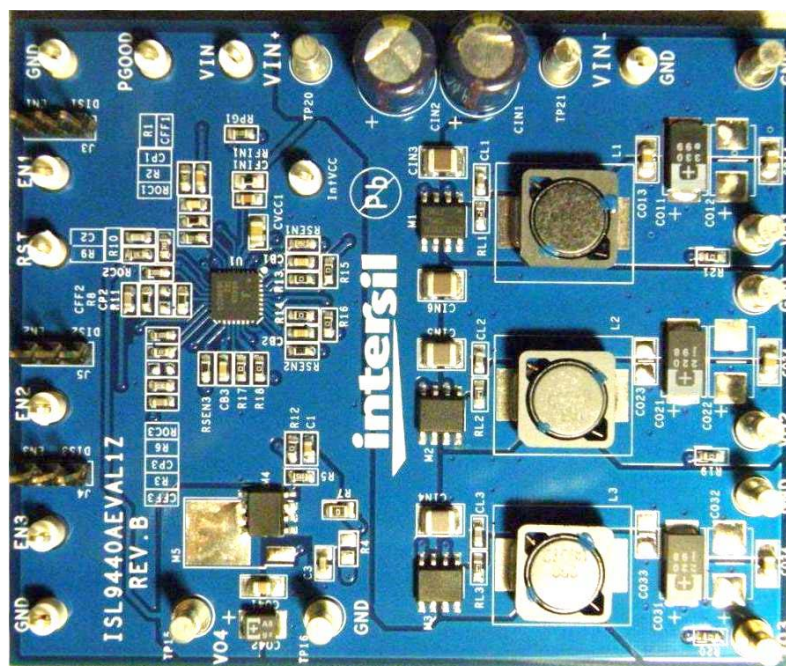

FIGURE 1. ISL9440AEVAL1Z EVALUATION BOARD

## Electrical Specifications

Recommended operation conditions unless otherwise noted. Refer to the "Schematic" on page 7 and "Typical Evaluation Board Performance Curves" on page 4.

PARAMETER	TEST CONDITIONS	MIN	TYP	MAX	UNITS
$V_{IN}$	All outputs are in regulation	6.0	12	16	V
$V_{OUT1}$		0.97	1.00	1.03	V
$V_{OUT2}$		3.25	3.32	3.4	V
$V_{OUT3}$		4.85	5.0	5.15	V
$V_{OUT4}$		2.43	2.50	2.57	V
PWM1 Rated Current	$V_{IN} = 12V$ , $T_A = +25^\circ C$ , No forced airflow, all three PWM outputs are fully loaded		6	7	A
PWM2 Rated Current			6	7	A
PWM3 Rated Current			4	5	A
LDO Rated Current	$R_7 = 0\Omega$ , $R_4$ is not populated		0.8	1.0	A
$V_{OUT1}$ Peak-to-Peak Ripple	$V_{IN} = 12V$ , all three PWM outputs are fully loaded, oscilloscope is with full bandwidth		19.4		mV <sub>P-P</sub>
$V_{OUT2}$ Peak-to-Peak Ripple			36.6		mV <sub>P-P</sub>
$V_{OUT3}$ Peak-to-Peak Ripple			32.2		mV <sub>P-P</sub>

## What's Inside

The Evaluation Board Kit contains the following materials:

- The ISL9440AEVAL1Z
- The ISL9440, ISL9440A, ISL9441 datasheet [FN6383](#)
- This Evaluation Board Kit document (AN1551)

## Recommended Equipment

The following materials are recommended to perform testing:

- 0V to 20V Power Supply with at least 10A source current capability
- Three electronic loads capable of sinking current up to 7A
- Digital Multimeters (DMMs)
- 100MHz Quad-Trace Oscilloscope
- Signal Generator (for load transient tests)

## Quick Test Guide

1. Ensure that the circuit is correctly connected to the supply and electronic loads prior to applying any power. Please refer to Figure 2 for proper set-up.
2. Connect Jumpers  $J_3$ ,  $J_4$  and  $J_5$  in the ENx positions.
3. Turn on the power supply.
4. Adjust input voltage  $V_{IN}$  within the specified range and observe output voltage. The output voltage variation should be within 3%.
5. Adjust load current within the specified range and observe output voltage. The output voltage variation should be within 3%.
6. Use oscilloscope to observe output voltage ripple and phase node ringing. For accurate measurement, refer to Figure 3 for proper test set-up.

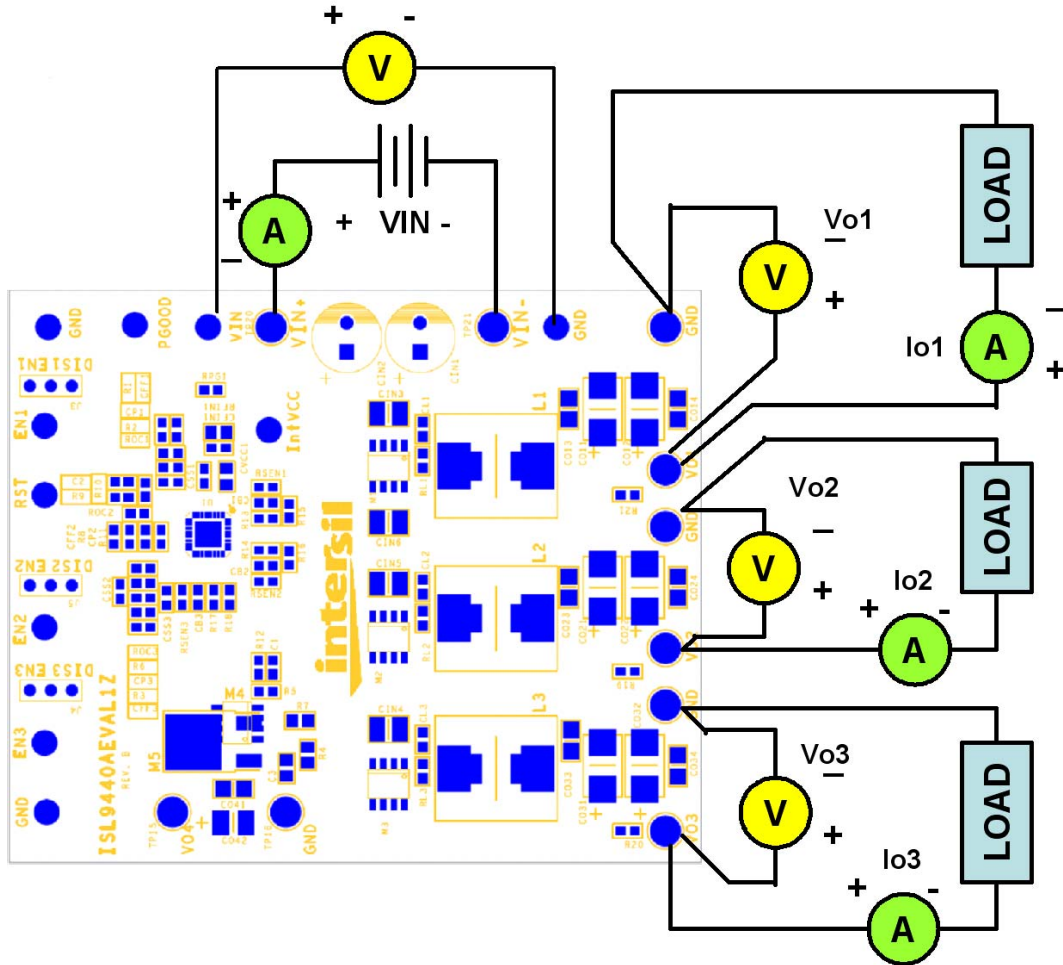

FIGURE 2. PROPER TEST SET-UP

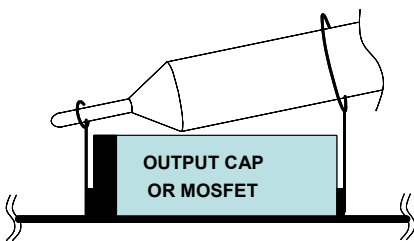

FIGURE 3. PROPER PROBE SET-UP TO MEASURE OUTPUT RIPPLE AND PHASE NODE RINGING

## Load Transient Circuit Set-Up

1. Select a SOIC8 N-Channel MOSFET with VDS breakdown >20V.
2. Install the load transient circuit as indicated on the schematic. Refer to Figure 4 for detail.
3. R<sub>27</sub>, R<sub>22</sub> and R<sub>25</sub> are 10kΩ resistors for discharging the MOSFET gates.
4. R<sub>26</sub>, R<sub>23</sub> and R<sub>24</sub> are current sensing resistors to monitor the load step. For accurate measurement, please use 5% tolerance sensing resistor or better. To alleviate thermal stress, use 0.1Ω or smaller resistance. The resistance of the sensing resistors sets the current scale on the oscilloscope.
5. Apply pulse square waveform across R<sub>27</sub>, R<sub>22</sub> or R<sub>25</sub>. The duty cycle of the pulse waveform should be small (<5%) to limit thermal stress on current sensing resistor and the MOSFETs (M<sub>8</sub>, M<sub>6</sub> or M<sub>7</sub>).
6. The amplitude of the clock sets the current step amplitude. Adjust the clock amplitude and slew rate to set the current step and slew rate.
7. Monitor overshoot and undershoot at corresponding output.

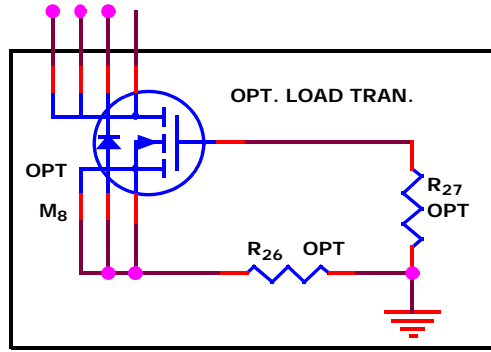

FIGURE 4. LOAD TRANSIENT CIRCUIT FOR PWM1

## Typical Evaluation Board Performance Curves

$V_{IN} = 12V$ ,  
Unless Otherwise Noted.

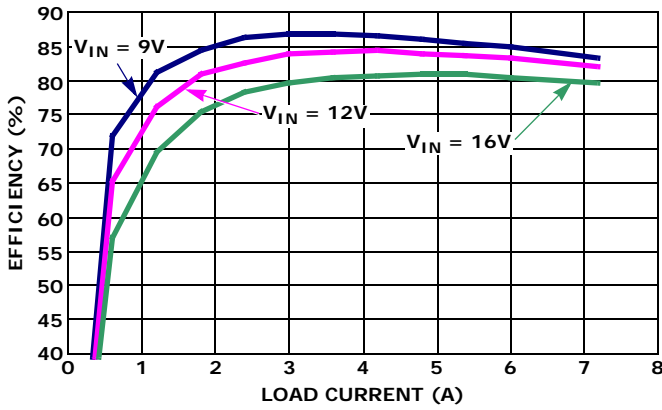

FIGURE 5. PWM1 EFFICIENCY vs LOAD ( $V_O = 1.0V$ )

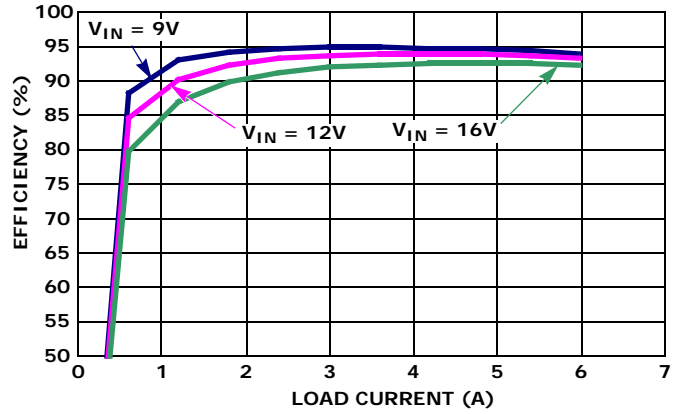

FIGURE 6. PWM2 EFFICIENCY vs LOAD ( $V_O = 3.3V$ )

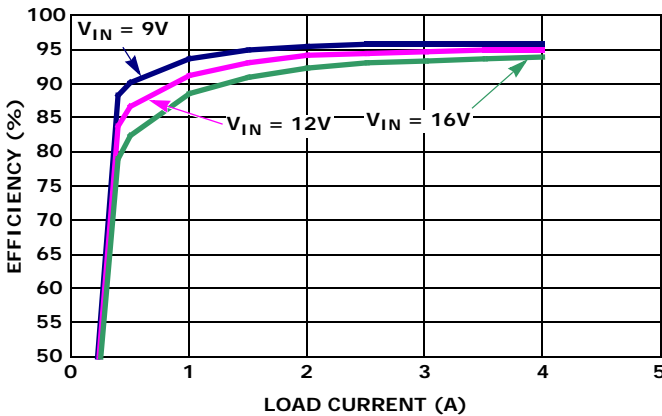

FIGURE 7. PWM3 EFFICIENCY vs LOAD ( $V_O = 5.0V$ )

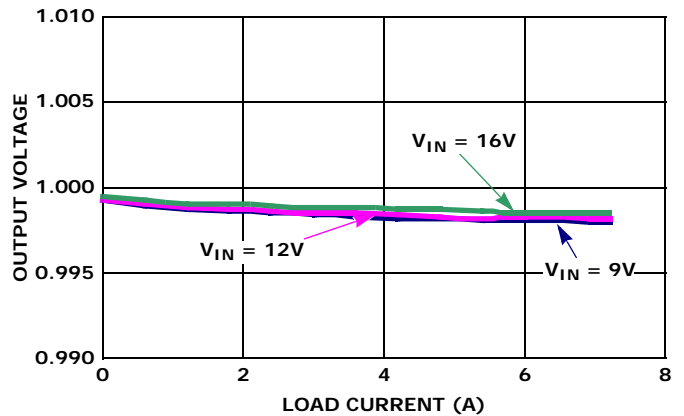

FIGURE 8. PWM1 REGULATION CURVES (PWM2, PWM3 DISABLED)

Typical Evaluation Board Performance Curves

$V_{IN} = 12V$ ,  
Unless Otherwise Noted. (Continued)

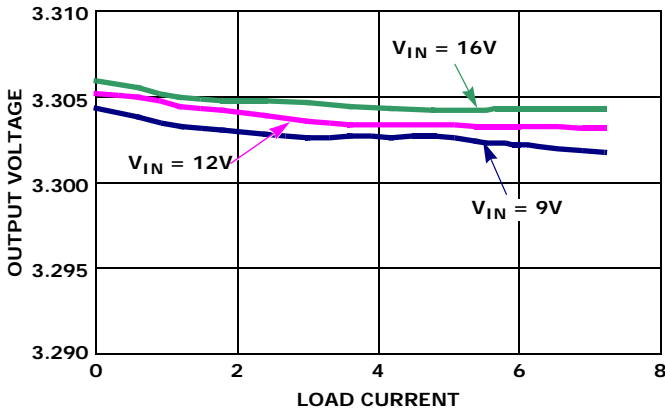

FIGURE 9. PWM2 REGULATION CURVES (PWM1, PWM3 DISABLED)

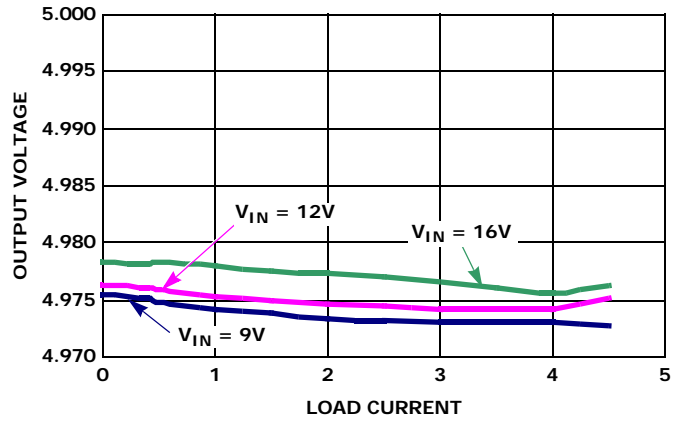

FIGURE 10. PWM3 REGULATION CURVES (PWM1, PWM2 DISABLED)

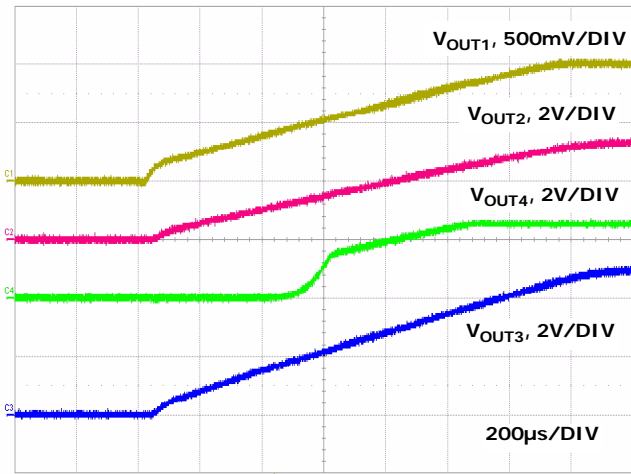

FIGURE 11. SOFT-START CURVES

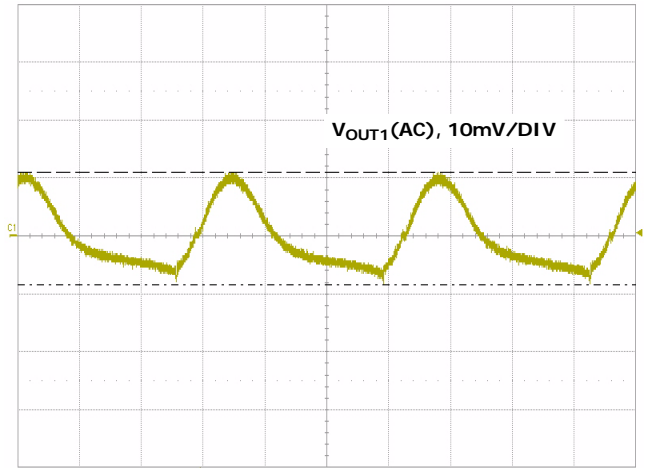

FIGURE 12. PWM1 OUTPUT RIPPLE UNDER MAX LOAD ( $V_{IN} = 12V$ ,  $I_{O1} = I_{O2} = 6A$ ,  $I_{O3} = 4A$ , FULL BANDWIDTH)

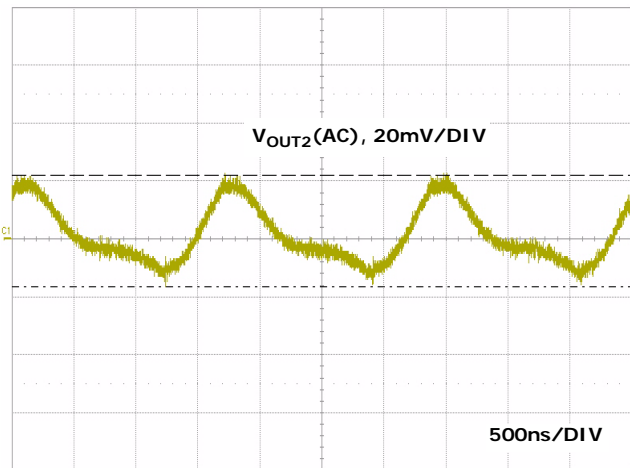

FIGURE 13. PWM2 OUTPUT RIPPLE UNDER MAX LOAD ( $V_{IN} = 12V$ ,  $I_{O1} = I_{O2} = 6A$ ,  $I_{O3} = 4A$ , FULL BANDWIDTH)

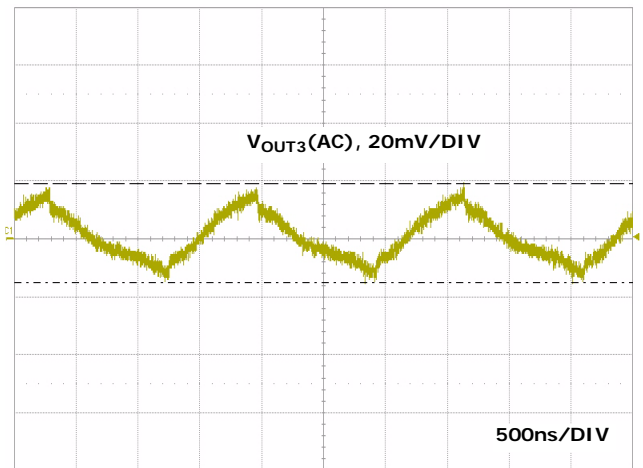

FIGURE 14. PWM3 OUTPUT RIPPLE UNDER MAX LOAD ( $V_{IN} = 12V$ ,  $I_{O1} = I_{O2} = 6A$ ,  $I_{O3} = 4A$ , FULL BANDWIDTH)

# Typical Evaluation Board Performance Curves $V_{IN} = 12V$ , Unless Otherwise Noted. (Continued)

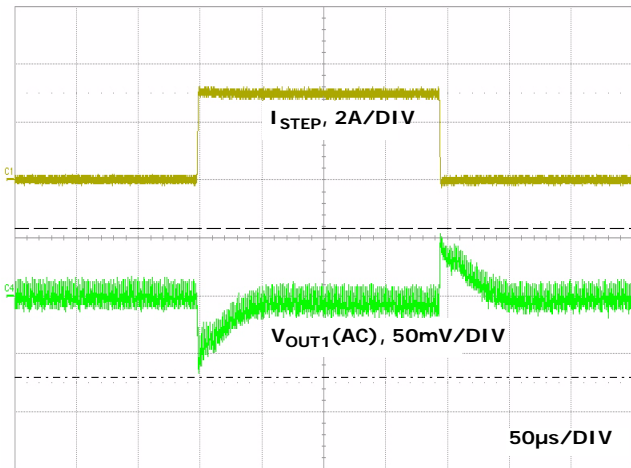

FIGURE 15. PWM1 LOAD TRANSIENT RESPONSE (LOAD STEP FROM 1.5A TO 4.5A)

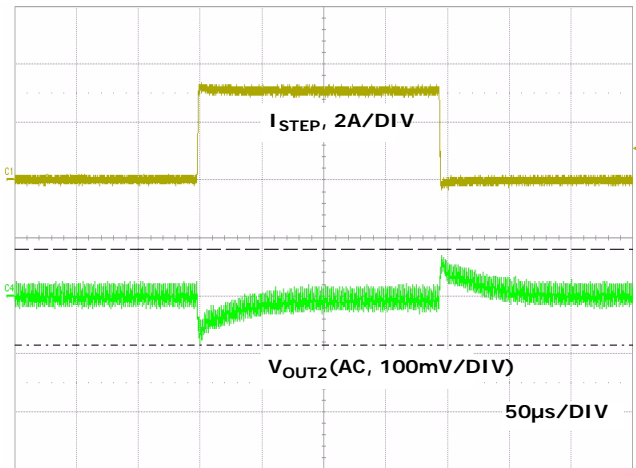

FIGURE 16. PWM2 LOAD TRANSIENT RESPONSE (LOAD STEP FROM 1.5A TO 4.5A)

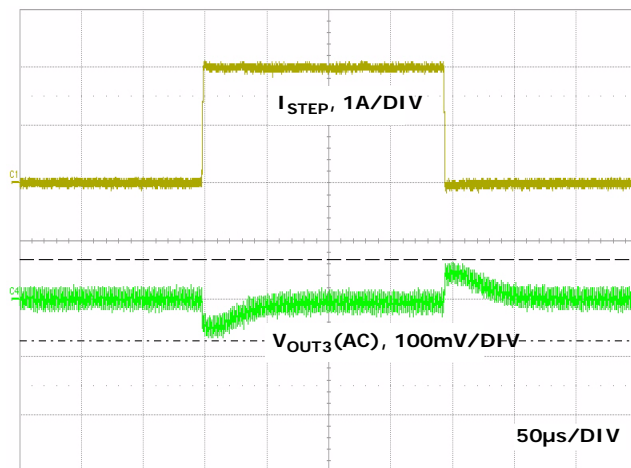

FIGURE 17. PWM3 LOAD TRANSIENT RESPONSE (LOAD STEP FROM 1A TO 3A)

# Schematic

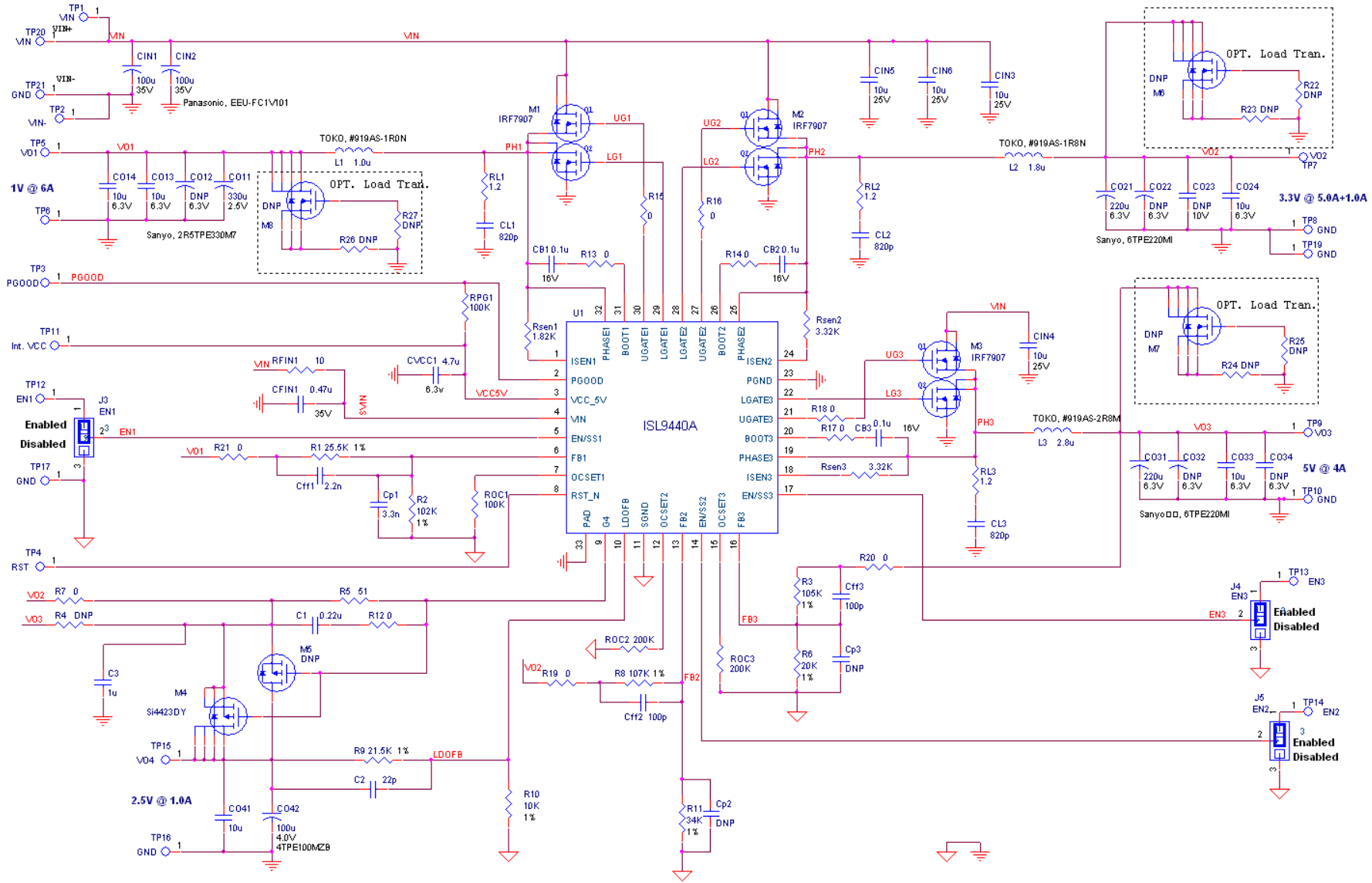

TABLE 2. BILL OF MATERIALS

ESSENTIAL COMPONENTS						
ITEM	QTY	PART REFERENCE	VALUE	DESCRIPTION	PART #	MANUFACTURER
1	3	CB1, CB2, CB3	0.1 $\mu$ F	CAP Ceramic X5R, 16V, SMD, 0603		Generic
2	1	CFIN1	0.47 $\mu$ F	CAP Ceramic X5R, 25V, SMD, 0603		Generic
3	2	CIN1, CIN2	100 $\mu$ F	Alum. Elec. CAP 35V	EEU-FC1V101	Panasonic
4	4	CIN3, CIN4, CIN5, CIN6	10 $\mu$ F	CAP Ceramic X5R, 35V, SMD, 1206		Generic
5	3	CL1, CL2, CL3	820pF	CAP Ceramic X5R, 50V, SMD, 0603		Generic
6	1	CO11	330 $\mu$ F	POSCAP, 2.5V, SMD, D2E	2R5TPE330M7	Sanyo
7	5	CO13, CO14, CO24, CO33, CO41	10 $\mu$ F	CAP Ceramic X5R, 6.3V, SMD, 0805		Generic
8	2	CO21, CO31	220 $\mu$ F	POSCAP, 6.3V, SMD, D2E	6TPE220MI	Sanyo
9	1	CO42	100 $\mu$ F	POSCAP, 4.0V, SMD, B	4TPE100MZB	Sanyo
10	1	CVCC1	4.7 $\mu$ F	CAP Ceramic X5R, 6.3V, SMD, 0805		Generic
11	1	Cff1	2.2nF	CAP Ceramic, SMD, 0603		Generic
12	2	Cff2, Cff3	100pF	CAP Ceramic, SMD, 0603		Generic
13	1	Cp1	3.3nF	CAP Ceramic, SMD, 0603		Generic
14	1	C1	0.22 $\mu$ F	CAP Ceramic X5R, 16V, SMD, 0603		Generic
15	1	C2	22pF	CAP Ceramic X5R, 16V, SMD, 0603		Generic
16	1	C3	1 $\mu$ F	CAP Ceramic X5R, 16V, SMD, 0603		Generic
17	1	L1	1.0 $\mu$ H	SHIELDED INDUCTOR	#919AS-1R0N	TOKO
18	1	L2	1.8 $\mu$ H	SHIELDED INDUCTOR	#919AS-1R8N	TOKO
19	1	L3	2.8 $\mu$ H	SHIELDED INDUCTOR	#919AS-2R8M	TOKO
20	3	M1, M2, M3		Dual N MOSFET, 30V, SOIC8	IRF7907	International Rectifier
21	1	M4		P MOSFET, SOIC8	Si4423DY	Vishay
22	1	R <sub>FIN1</sub>	10 $\Omega$	RESISTOR, SMD, 0805, 10%		Generic
23	3	RL1, RL2, RL3	1.2 $\Omega$	RESISTOR, SMD, 0603, 10%		Generic
24	2	RPG1, ROC1	100k $\Omega$	RESISTOR, SMD, 0603, 1%		Generic
25	2	ROC2, ROC3	200k $\Omega$	RESISTOR, SMD, 0603, 1%		Generic
26	1	R <sub>SEN1</sub>	1.82k $\Omega$	RESISTOR, SMD, 0603, 1%		Generic
27	2	R <sub>SEN2</sub> , R <sub>SEN3</sub>	3.32k $\Omega$	RESISTOR, SMD, 0603, 1%		Generic
28	1	R1	25.5k $\Omega$	RESISTOR, SMD, 0603, 1%		Generic
29	1	R2	102k $\Omega$	RESISTOR, SMD, 0603, 1%		Generic
30	1	R3	105k $\Omega$	RESISTOR, SMD, 0603, 1%		Generic
31	1	R5	51 $\Omega$	RESISTOR, SMD, 0603, 1%		Generic
32	1	R6	20k $\Omega$	RESISTOR, SMD, 0603, 1%		Generic
33	1	R8	107k $\Omega$	RESISTOR, SMD, 0603, 1%		Generic
34	1	R9	21.5k $\Omega$	RESISTOR, SMD, 0603, 1%		Generic
35	1	R10	10k $\Omega$	RESISTOR, SMD, 0603, 1%		Generic



TABLE 2. BILL OF MATERIALS (Continued)

ESSENTIAL COMPONENTS						
ITEM	QTY	PART REFERENCE	VALUE	DESCRIPTION	PART #	MANUFACTURER
36	1	R11	34k $\Omega$	RESISTOR, SMD, 0603, 1%		Generic
37	1	U1		QUAD OUTPUT CONTROLLER	ISL9440AIRZ	Intersil
OPTIONAL COMPONENTS OR RESISTOR JUMPERS						
ITEM	QTY	REFERENCE	VALUE	DESCRIPTION	PART #	MANUFACTURER
38	10	R7, R12, R13, R14, R15, R16, R17, R18, R19, R20, R21	0	RESISTOR Jumpers, SMD, 0603, 10%		Generic
39	3	CO12, CO22, CO32	DNP			
40	2	CO23, CO34	DNP			
41	2	Cp2, Cp3	DNP			
42	1	M5	DNP	P MOSFET TO-252		
43	3	M6, M7, M8	DNP	N MOSFET		
44	4	R4, R22, R25, R27	DNP	RESISTOR, SMD, 0603		
45	3	R23, R24, R26	DNP	RESISTOR, SMD, 1206		
EVALUATION BOARD HARDWARE						
ITEM	QTY	REFERENCE	VALUE	DESCRIPTION	PART #	MANUFACTURER
46	3	J3, J4, J5		3 Head Jumper	68000-236HLF	Generic
47	11	TP1, TP2, TP3, TP4, TP6, TP17, TP11, TP12, TP13, TP14, TP7		TEST POINT	5007	Keystone
48	9	TP8, TP10, TP16, TP19, TP21, TP9, TP5, TP15, TP20	GND	TURRET	1514-2	Keystone

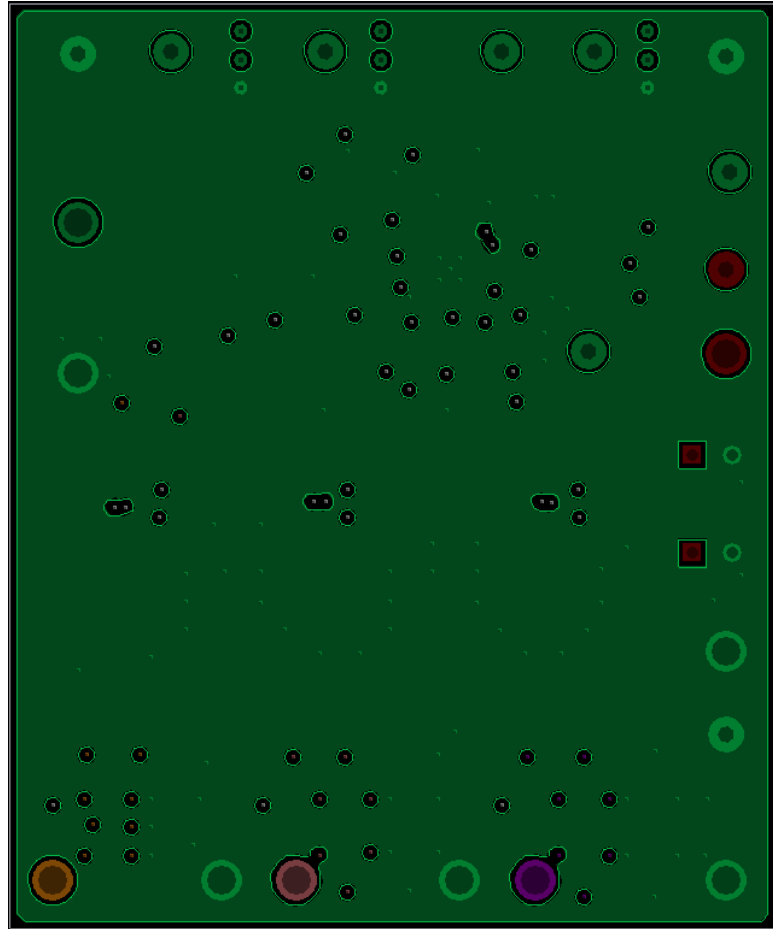

FIGURE 19. SECOND LAYER (SOLID GROUND)

# ISL9440CEVAL1Z PCB Layout

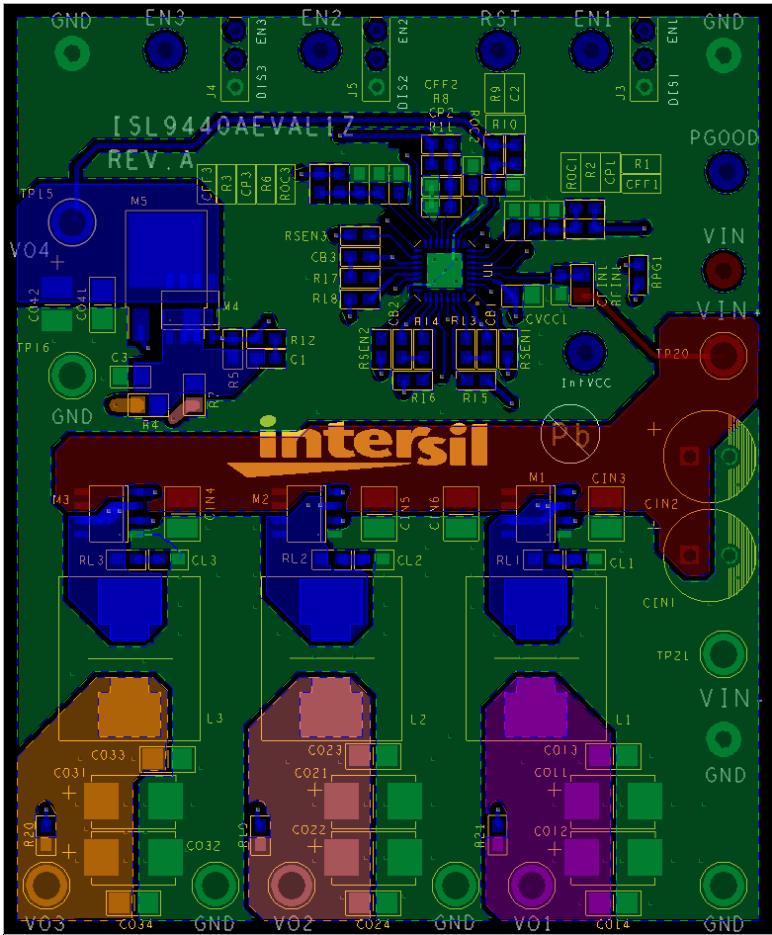

FIGURE 18. TOP LAYER

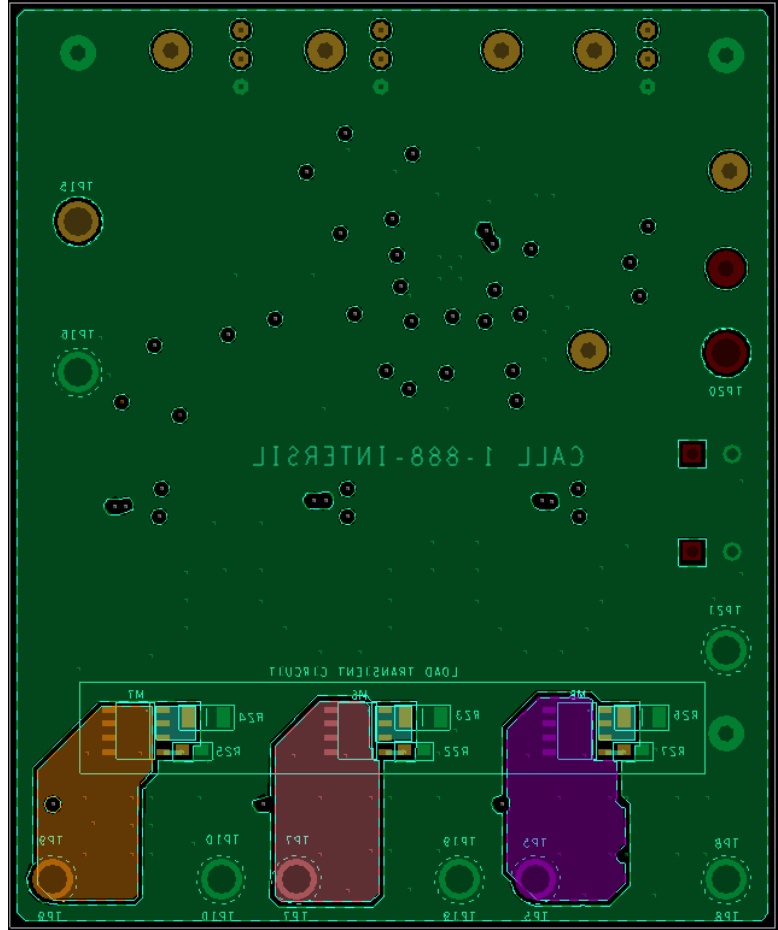

FIGURE 21. BOTTOM LAYER (MIRRORED)

# ISL9440CEVAL1Z PCB Layout (Continued)

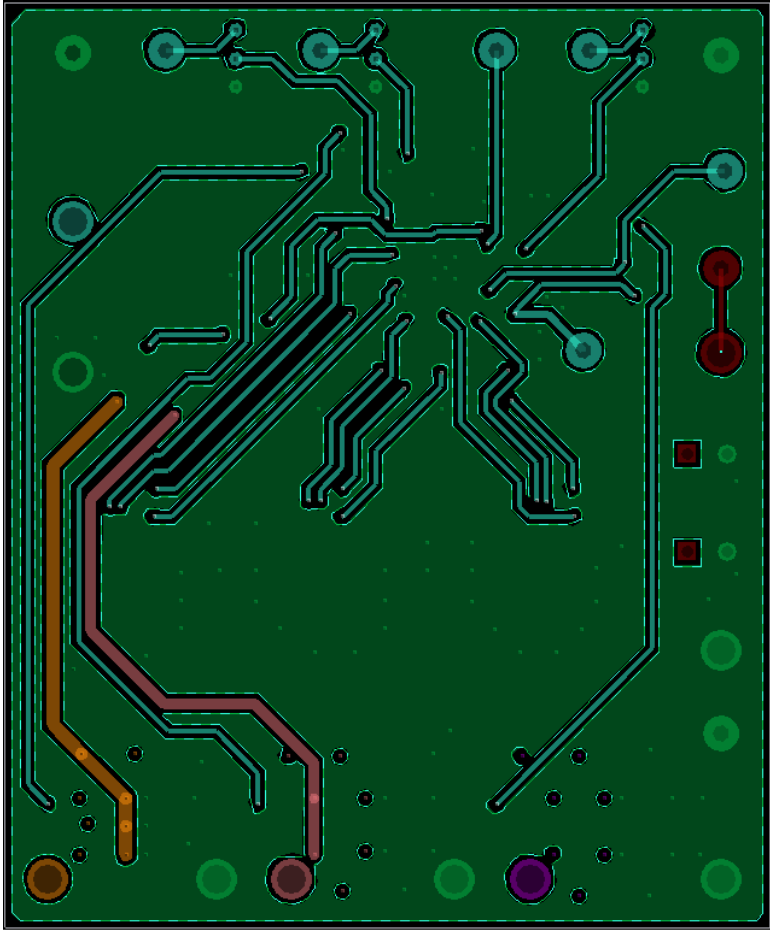

FIGURE 20. THIRD LAYER