

JESD204B High Speed ADC

Evaluation Kit

AN1809  
Rev 0.00  
Dec 5, 2012

The Intersil JESD204B High Speed ADC evaluation system allows users to evaluate the Intersil portfolio of low-power, 12- to 16-bit, high-performance analog-to-digital converters (ADC) with JESD204B high speed serial outputs. These converters run at sampling rates of 40MSPS to 500MSPS and their JESD204B outputs operate at rates from 1 to 4.375Gbps. The evaluation system uses the Intersil iEvalADC software, which displays all pertinent data such as SFDR, SINAD, ENOB, harmonics, current, and power measurements. The software also plots outputs in frequency spectra and time domain.

To begin testing, simply connect the input signal, sampling clock, and target computer to the motherboard, and supply power (Figure 1). The motherboard (ADCMB-HSFMCEV1Z) provides appropriate supply voltages and captures digital data from the daughter card. Daughter cards contain the ADCs and attach directly to the motherboard to form the ADC evaluation platform (Figure 2). To ensure proper operation of the system, it is recommended that the most current software version be installed. If Intersil iEvalADC is already installed on the machine, a new installation may proceed without removing the prior version.

Features

- Complete high-speed ADC measurement solution
- 40MSPS to 500MSPS operation
- Datasheet-style, live-updated display with calculation of critical ADC parameters (SNR, SFDR, SINAD, ENOB, Harmonics, Power)
- Multiple display modes: frequency (FFT), time domain
- Integrated SPI control for ADC configuration
- JESD204B receiver reference design (included with iEvalADC software)
- USB 2.0 interface for rapid data transfer
- 1M (2<sup>20</sup>) word capture depth

Evaluation System Contents

The evaluation system is provided with a USB cable to connect to a PC and a 5V power supply. The user need only provide signal and clock sources, optional filters, and a PC running the Microsoft Windows™ XP operating system with Java installed. Intersil iEvalADC software can be downloaded from the Intersil web site. Please visit [www.intersil.com/jesd204b](http://www.intersil.com/jesd204b) for more details.

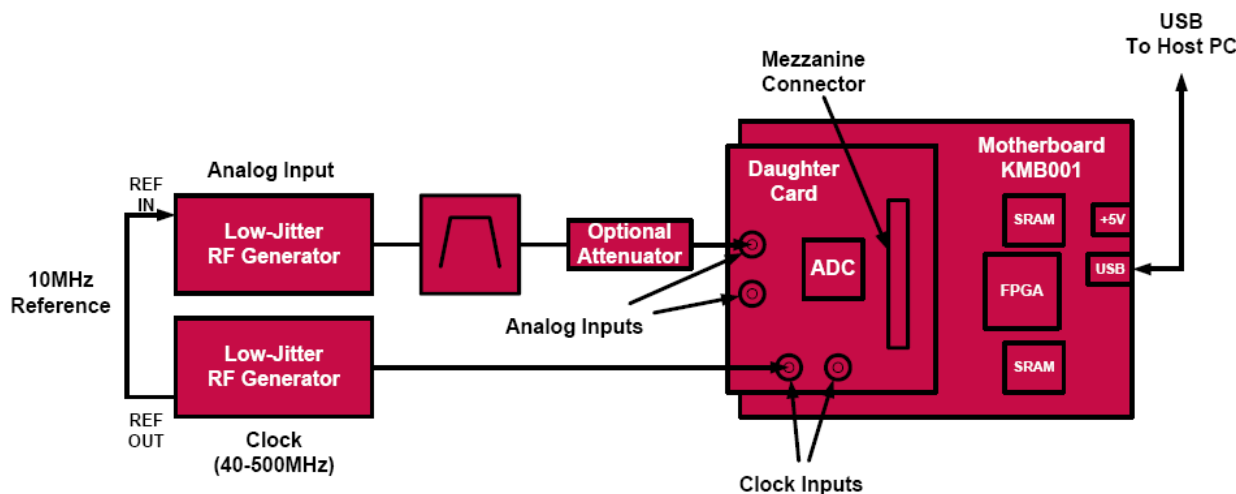

FIGURE 1. EVALUATION PLATFORM BLOCK DIAGRAM

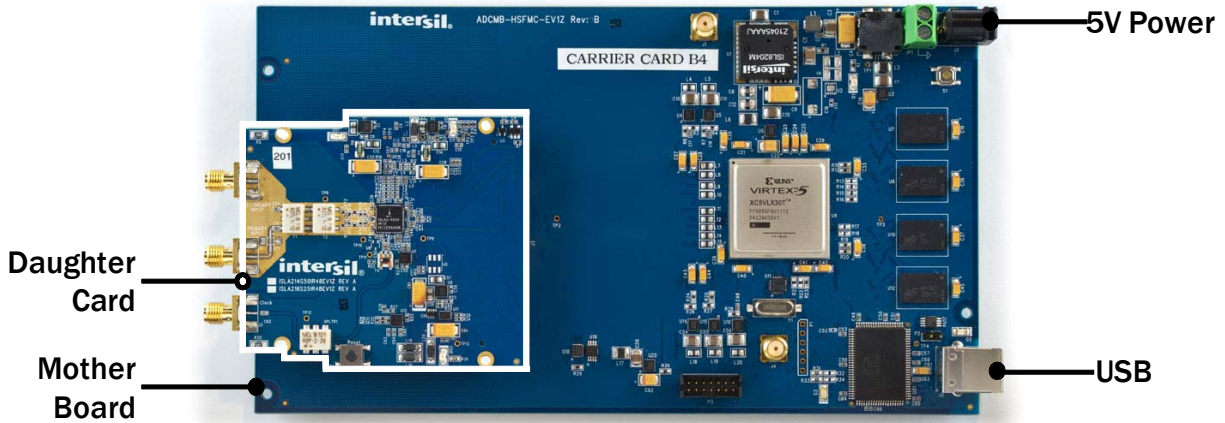

FIGURE 2. EXAMPLE EVALUATION BOARD CONNECTIONS SHOWING ISLA214S50 DAUGHTER CARD

## Installation Requirements

Before installing iEvalADC, please confirm the following:

- PC operating system is Windows XP
- The account that the software is installed from has administrator privileges.
- Java is installed.
  - The Java Runtime Environment is installed on the PC. If not, it can be installed by downloading from <http://java.com/>
  - Windows XP has associated files with the \*.jar extension with the java runtime environment. This is done by default during the java runtime environment install. You can modify your file extension associations by opening an explore window, clicking on the Tools drop down menu, selecting Folder Options, and interacting with the pop up window.

## Setup and Operation of the ADC Evaluation Platform

To set up the ADC evaluation platform, the following items are required:

1. Intersil ADCMB-HSFMC1Z motherboard
2. USB cable (USB-A to USB-B, 1.25 to 2M long) (supplied with ADCMB-HSFMC1Z)
3. 5V power supply, 18 W minimum (supplied with ADCMB-HSFMC1Z)
4. Intersil daughter card containing ADC to be tested (ordered separately)
5. Suitable signal and clock sources (see “Appendix A” on page 4)(supplied by user)
6. PC with free USB2.0 port, logged in with administrator rights (supplied by user)

## Installing the iEvalADC Software

1. Double click the installer executable (i.e., “Intersil\_iEvalADC\_V1.04.exe”). This will launch the installer, resulting in the following window. Click “Next”.



FIGURE 3.

2. The End User License Agreement will be displayed. In the License Agreement window, if you agree with the Software Evaluation License Agreement, click “I accept the terms of the License Agreement” radio button, then click “Next”.

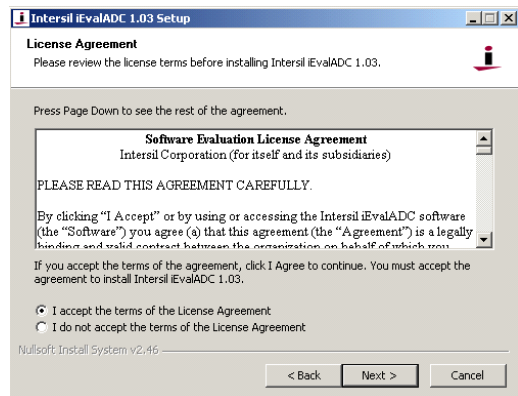

FIGURE 4.

3. The “Choose Install Location” window opens. Click "Next".

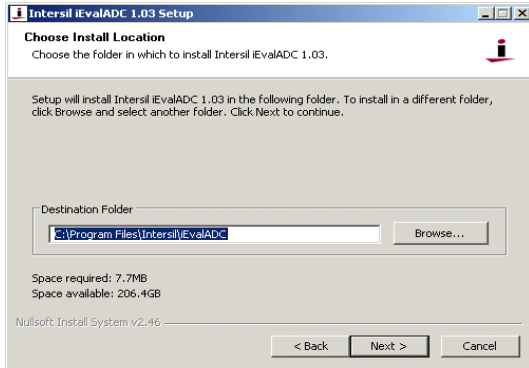

FIGURE 5.

4. The “Choose Start Menu Folder” opens. Click “Install”.

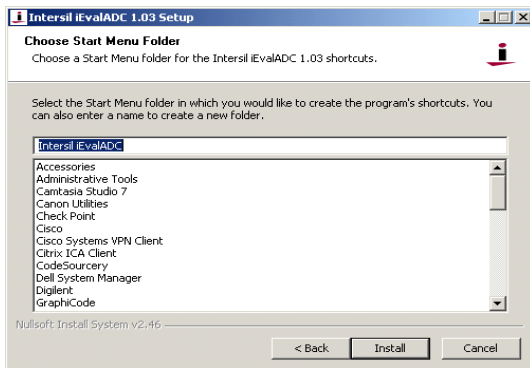

FIGURE 6.

5. The “Completing the Intersil iEvalADC Setup Wizard” window opens. Click “Finish”.

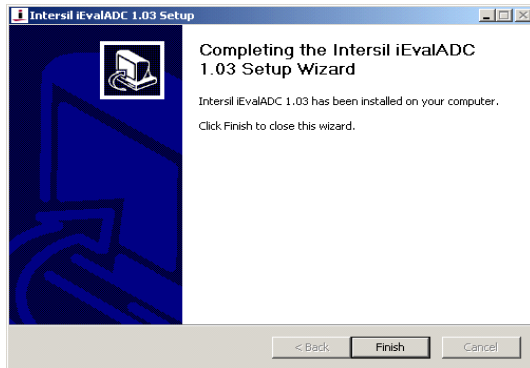

FIGURE 7.

6. Setup the hardware as shown in Figure 1.

7. Windows will automatically detect the new hardware and prompt for the appropriate driver via the “Found New Hardware Wizard”. Click “No, not this time”, then click "Next".



FIGURE 8.

8. The Software Installation wizard window will open. Click the “Install the software automatically (Recommended)” radio button, then click "Next".

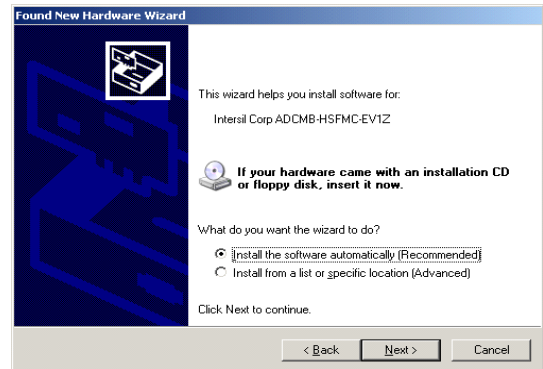

FIGURE 9.

9. The “Completing the Found New Hardware Wizard” window will open. Click “Finish”. (For common issues encountered during this process and solutions to these issues, please refer to “Appendix B” on page 4).



FIGURE 10.

10. Double click on the iEvalADC shortcut on the desktop to launch the application.

## Running the Software

Once the installation is complete, the software can be launched by double clicking on the shortcut located on the desktop, by default called “iEvalADC”. There is no need to attach the evaluation kit hardware to launch the software. The first time the program is launched, you may experience a delay as the Java runtime environment unpacks the required libraries. Subsequent runs will be much shorter. A window similar to the following will be displayed once iEvalADC has launched.

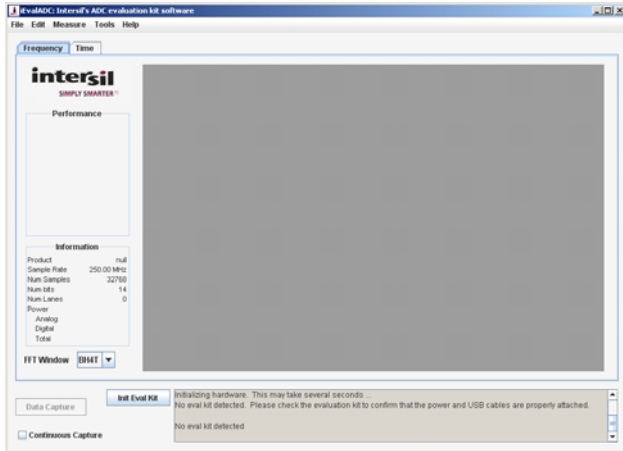

FIGURE 11.

Thank you for installing the iEvalADC software. For a complete user guide for iEvalADC, please refer to [Application Note 1809](#).

## Appendix A

### Source Requirements

Source jitter and noise will degrade performance. For best test results, a combined jitter (for both clock and signal sources) that does not exceed 200fs is recommended.

### Sample Clock and Input Signal Source Setup

Sample clock settings:

- 40MHz to 500MHz sine, +10dBm

Signal settings:

- 4.5MHz to 250MHz, +10dBm to +16dBm (depending on analog input attenuation)

## Appendix B

Sometimes there are multiple drivers that match the VID/PID characteristics of the hardware. In those cases, a window similar to the following will be displayed when trying to automatically install the driver. When this occurs, select the driver with the location of “c:\windows\inf\lcyusb.inf” and click “Next”.

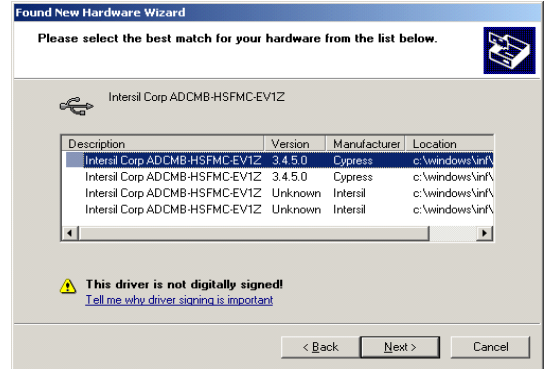

FIGURE 12.

Occasionally, windows will prompt for the 'ICYUSB.sys' file after selecting the icyusb.inf file. If so, the prompt will look something like the window displayed in Figure 13. If this prompt is displayed, fill in the install directory of iEvalADC along with the subdirectory, lib. Alternatively, browse to this directory. If you accepted the defaults during installation, the correct path will be C:\Program Files\Intersil\iEvalADC\lib. After entering the appropriate directory, click “OK”, then, click “Search for the best driver in these locations”. Also, make sure the check box “Include this location in the search” is selected and the directory highlighted is the install directory of iEvalADC with the “lib” subdirectory, and click “Next” or “OK”.

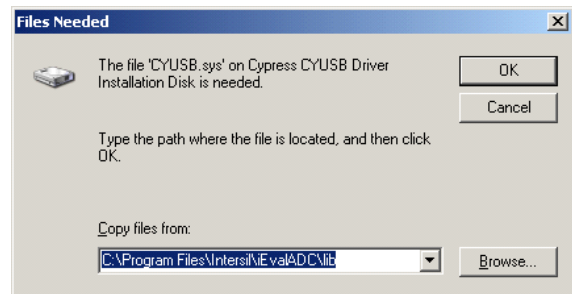

FIGURE 13.