

## Specification

Part No	:	<b>ISMP.915.35.6.A.02</b>
Product Name	:	Embedded ISM 915MHz Ceramic Patch Antenna (35x35x6mm)
Feature	:	Provides Compact Directive Pattern For RFID, LoRA, Sigfox and ISM 915MHz Applications 2dBi peak gain on 70x70mm ground plane 35x35x6mm Ceramic Patch Pin Mount Custom Tuning Optional RoHS Compliant



## 1. Introduction

ISMP.915 is a low-profile pin-mount ceramic patch antenna operating at 915 MHz. At just 35x35mm, it provides a high-performing antenna solution using minimum board space.

When mounted on a 70x70mm ground plane, ISMP.915 provides efficiency of over 75% and peak gain of 2.5 dBi. It is also right-hand circularly polarized, with an excellent axial ratio of less than 3 dB, providing maximum link reliability between devices where the orientation to each other is changing. These characteristics make it a perfect choice for compact fixed wireless applications operating on the 915 MHz ISM band, including remote instrumentation and RFID applications. It also provides excellent performance on Low-Power Wide-Area Networks (LPWAN) operating at 915 MHz, such as LoRa and Sigfox, allowing users to take advantage of the low-power, long-range communications offered by these networks.

Like all antennas the ISMP.915 will perform differently subject to nearby device environment and ground-plane changes compared to specification. Taoglas offers custom tuning for specific device environments and ground-planes, subject to NRE and MOQ. Contact your regional Taoglas sales office for these services as well as additional support with device integration. 3D STEP file available for ease of mechanical integration.



## 2. Specification

Electrical	
Frequency	915 MHz
Return Loss	-10dB max.
Efficiency	77.1 %
Average Gain	-1.13 dB
Peak Gain	2.51 dBi typ.
Axial Ratio	3.0 max @ Zenith
Polarization	RHCP
Impedance	50 $\Omega$
Mechanical	
Dimensions	35 x 35 x 6 mm
Material	Ceramic
Pin Diameter	0.9 mm
Pin Length	2.4 mm
Weight	34.3 g
Environmental	
Operation Temperature	-40°C to 85°C
Storage Temperature	-40°C to 105°C
Humidity	Non-condensing 65°C 95% RH

\* Antenna properties were measured with the antenna mounted on 70\*70mm Ground Plane

### 3. Antenna Characteristics

#### 3.1 Return Loss

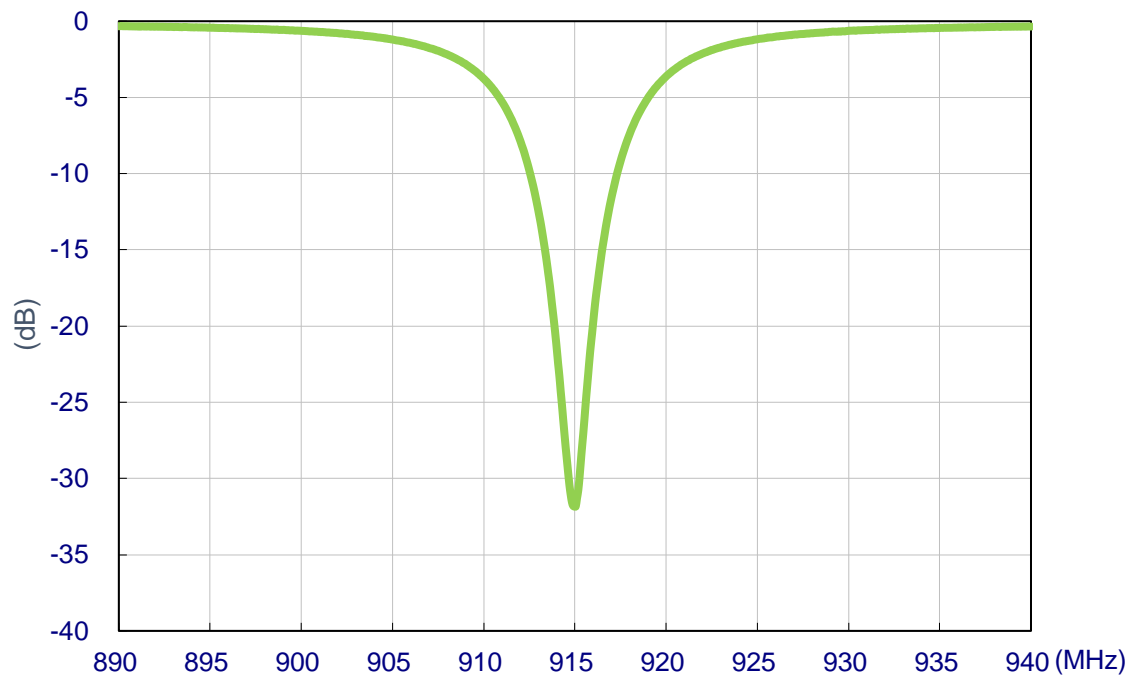

#### 3.3 Efficiency

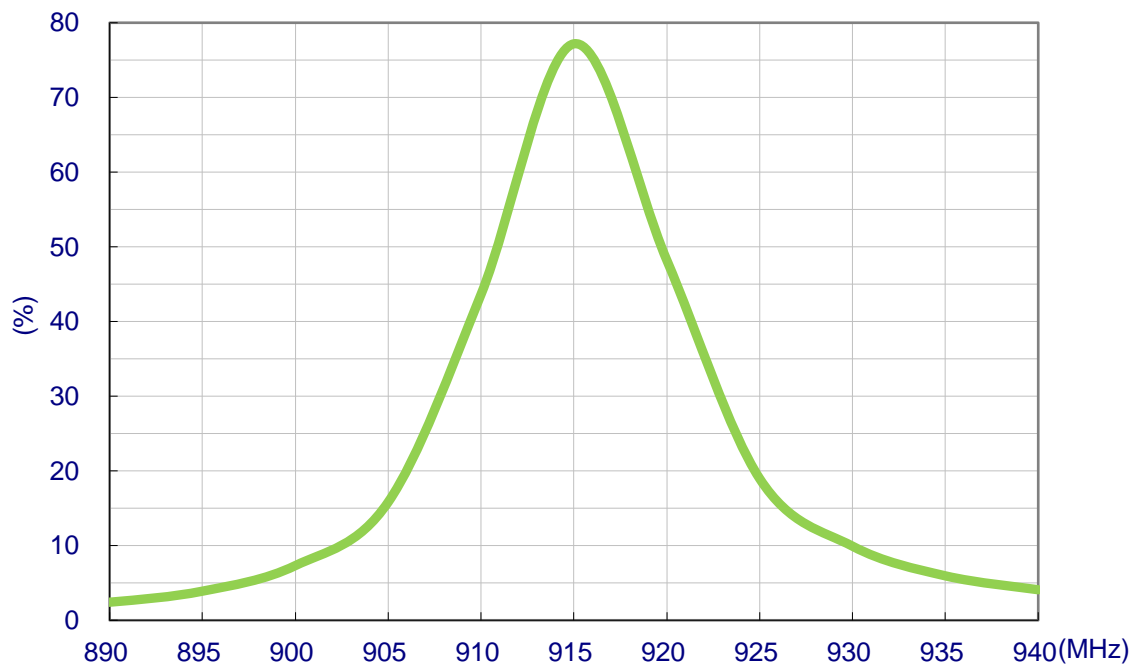

### 3.4 Peak Gain

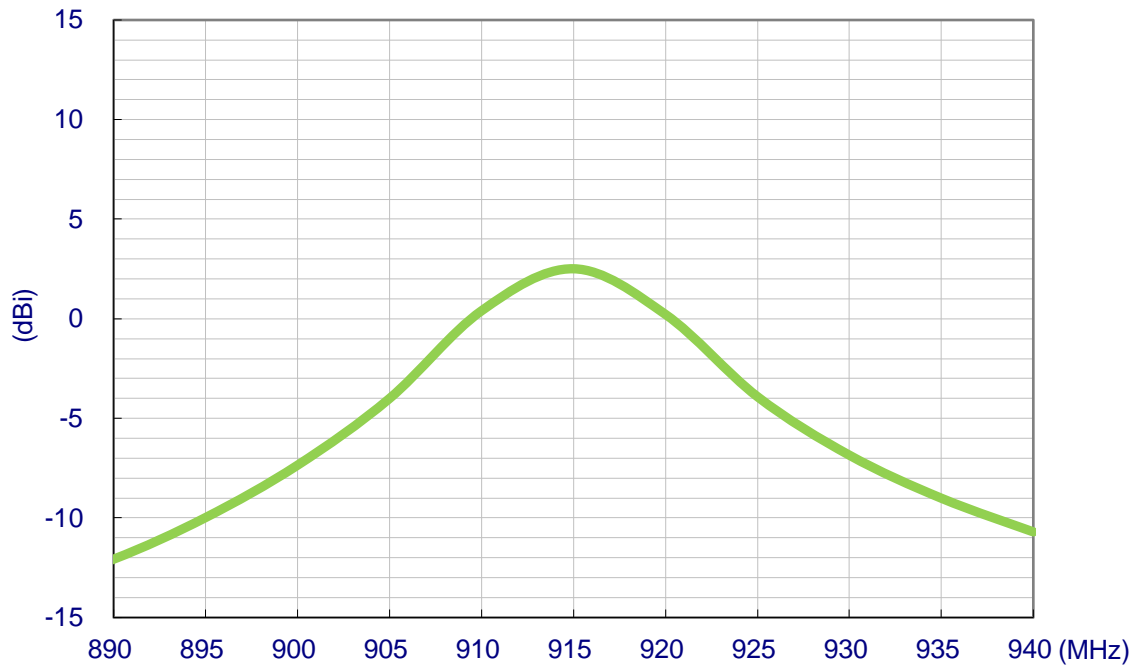

### 3.5 Average Gain

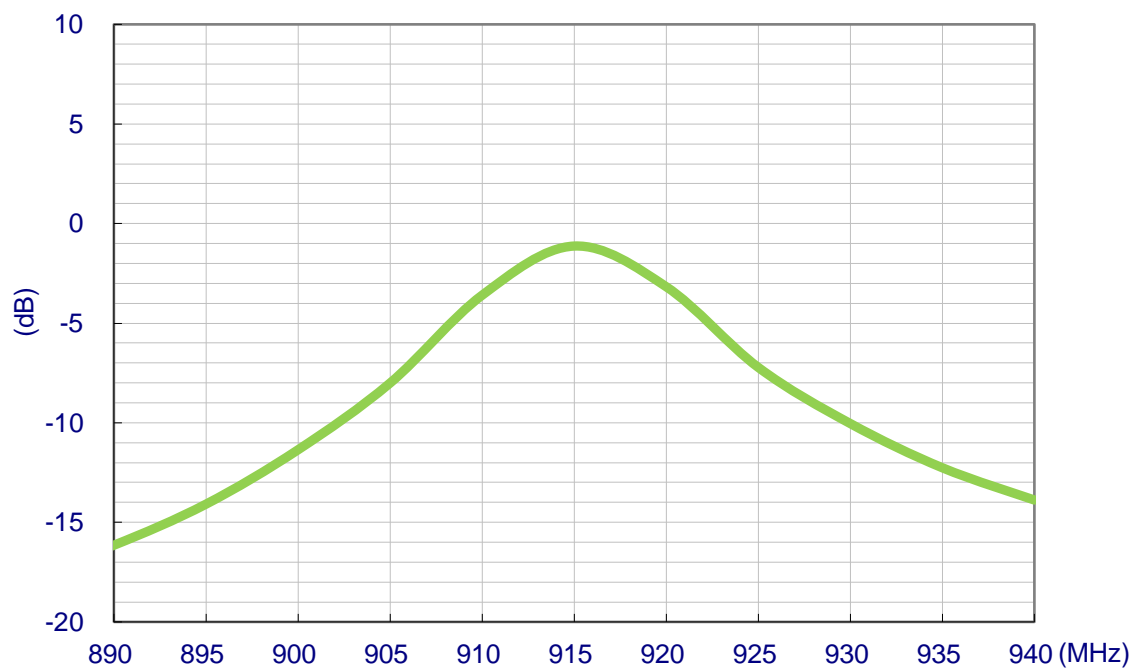

### 3.6 Axial Ratio (Zenith is at 0 degrees)

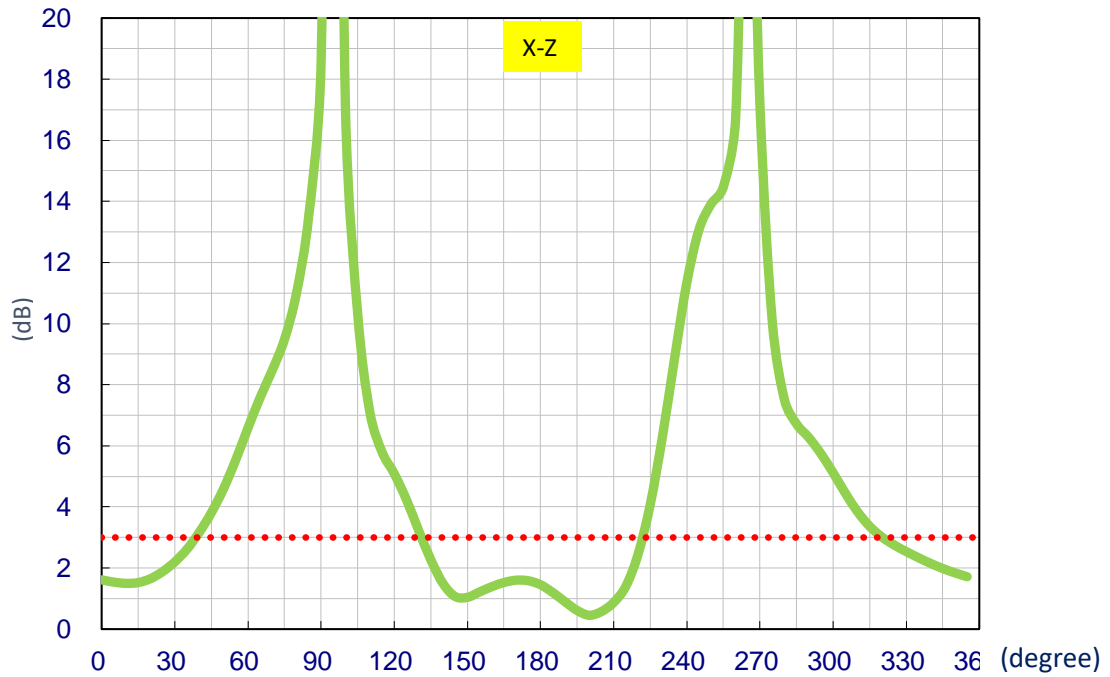

## 4. 2D Radiation Pattern

### 70x70mm Ground Plane - 915 MHz

#### 4.1 Test Setup

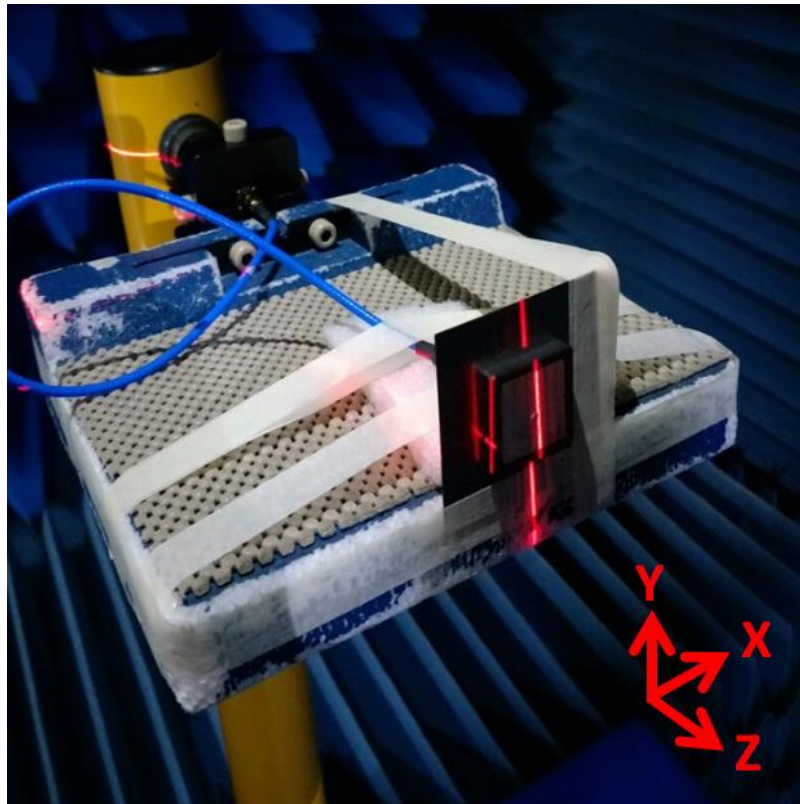

## 4.2 X-Y Plane

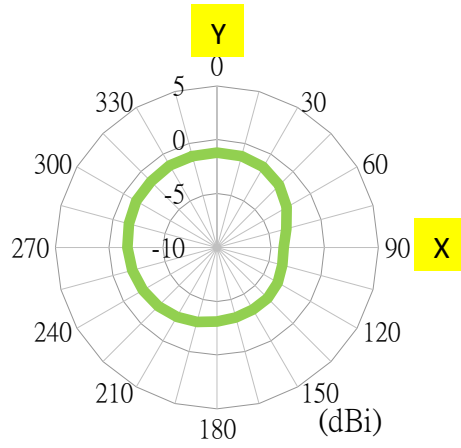

## X-Z Plane

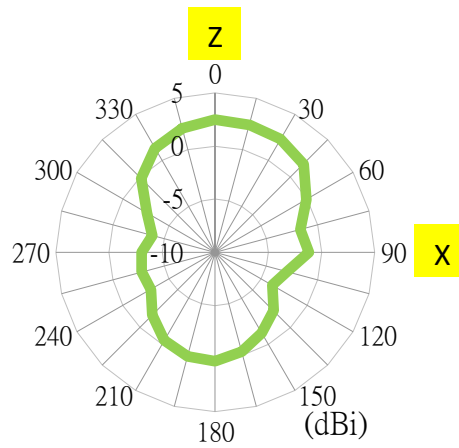

## Y-Z Plane

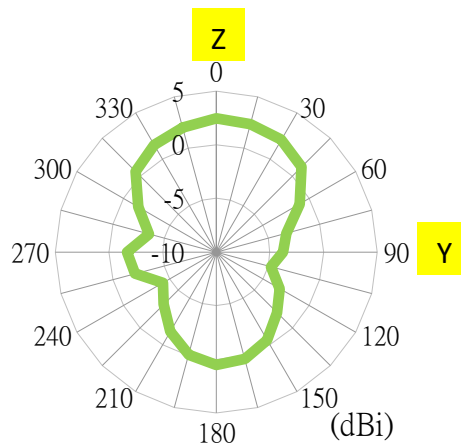



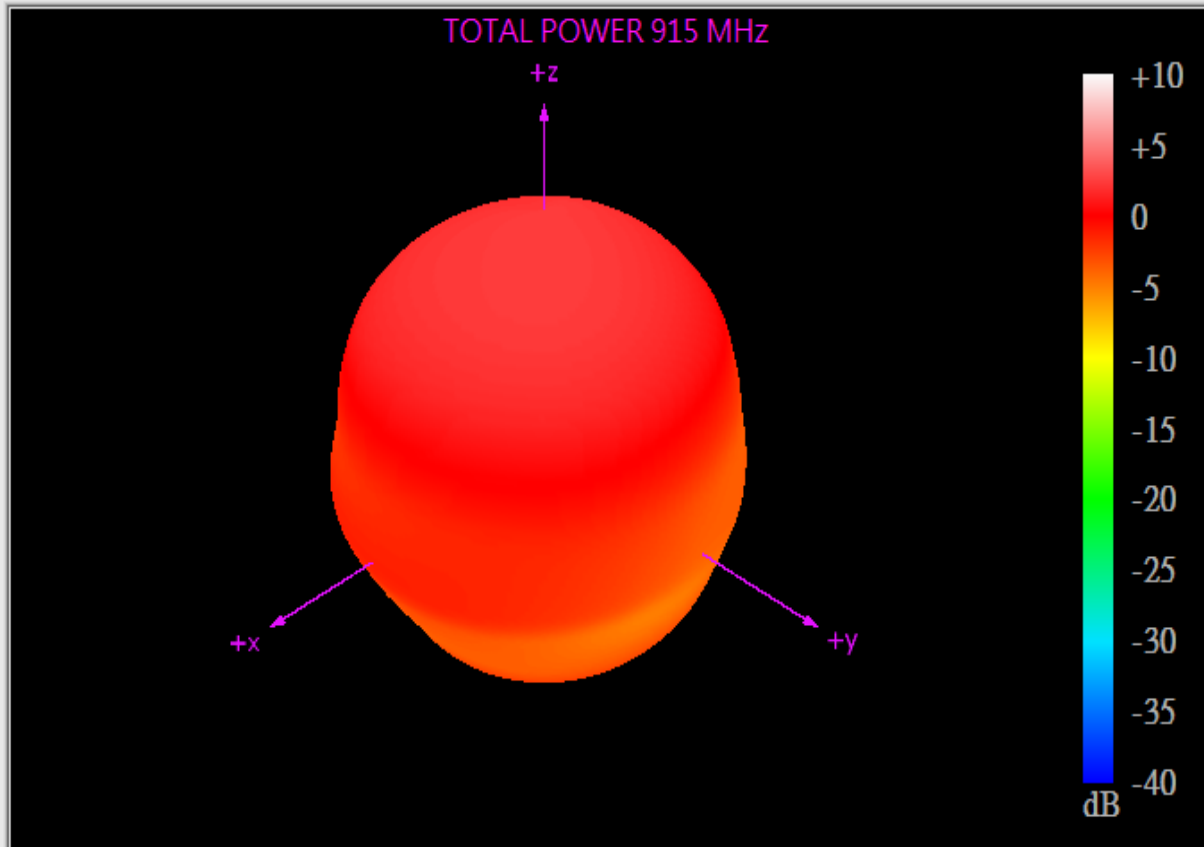

## 5. 3D Radiation Pattern on 70x70mm

Ground Plane – 915 MHz

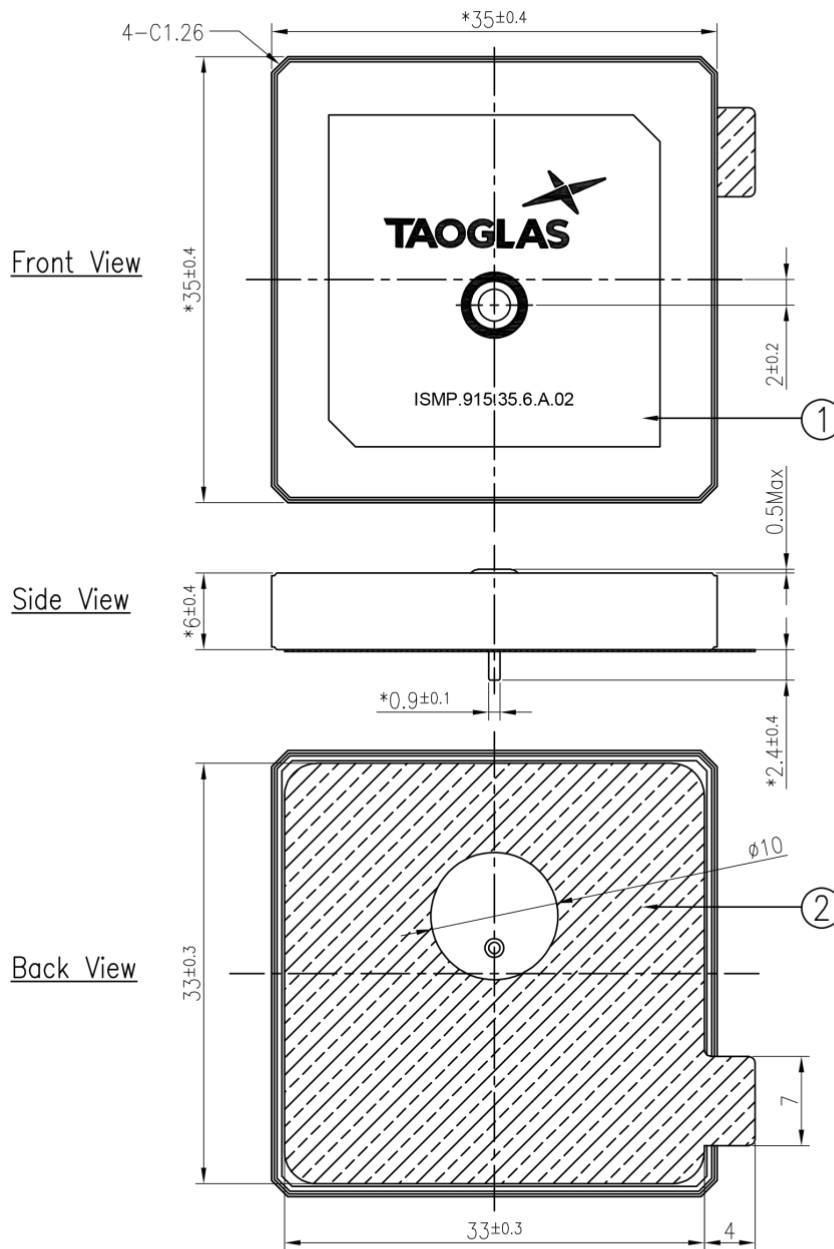

## **6. Mechanical Drawing-Patch**



- NOTES:
1. Double Sided Adhesive Area. 
  2. Soldermask Area 
  3. " \* " Critical Dimensions.

	Name	P/N	Material	Finish	QTY
1	Patch (35x35x6mm)	001518C060000A	Ceramic	Clear	1
2	Double sided Adhesive	001518C060000A	NITTO 5015	White Linter	1

## 6.1 Adhesive Thickness

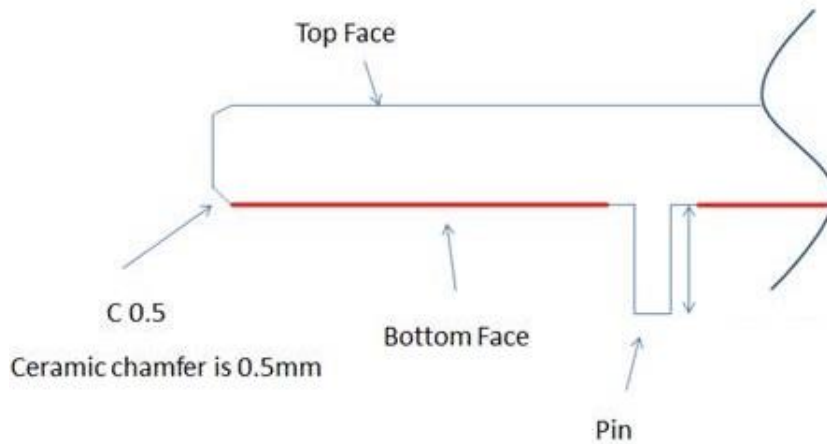

**Red Line** shows the adhesive without Liner – thickness 0.08~0.1mm

## 7. PCB Footprint Recommendation

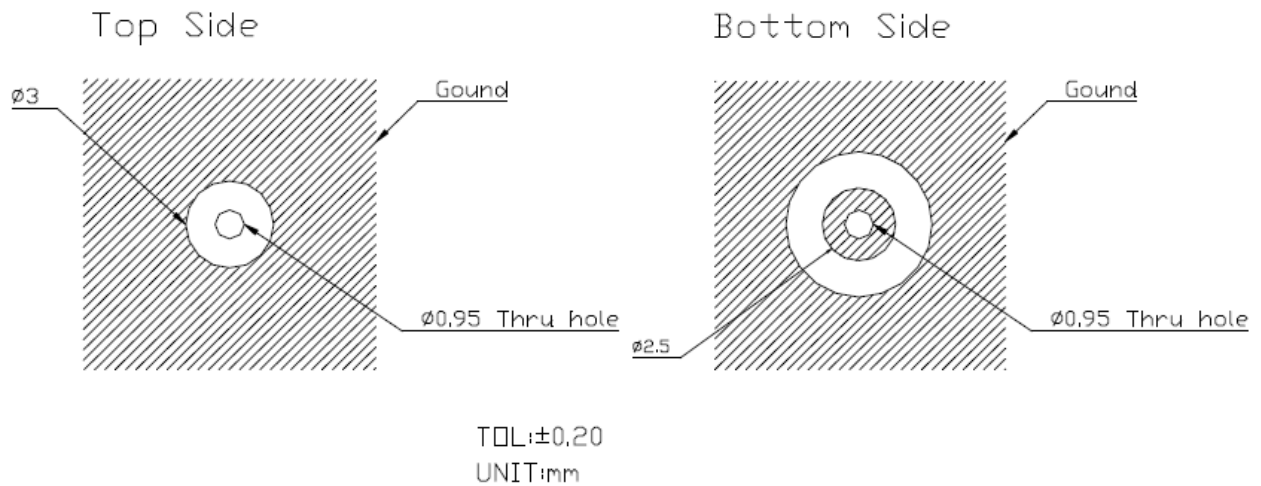

## 8. Packaging

12 pcs ISMP.915.35.6.A.02 per tray  
 Tray Dimensions - 257\*147\*17mm  
 Weight - 450g

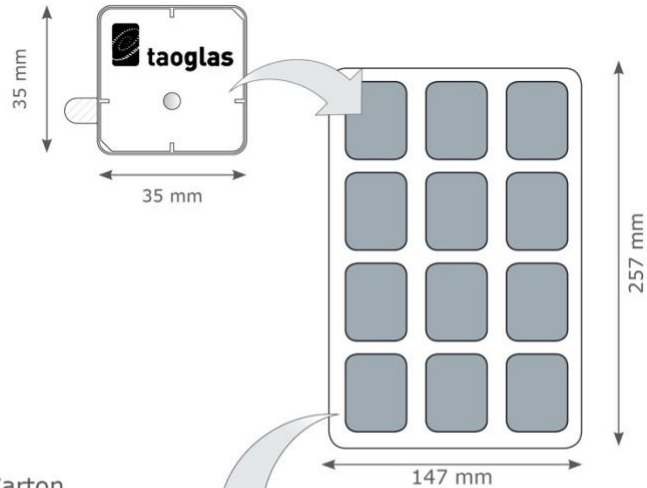

72 pcs ISMP.915.35.6.A.02 per Inner Carton  
 Carton Dimensions - 260 x 150 x 120mm  
 Weight - 2.86kg

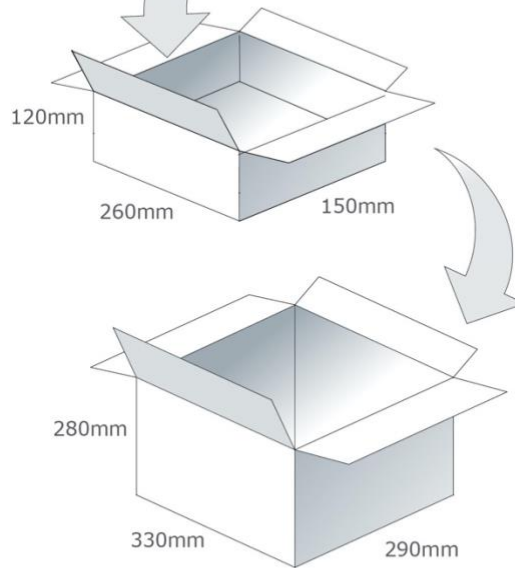

4 Inner Cartons per Large Carton  
 288 pcs ISMP.35 per Large Carton  
 Carton Dimensions - 330\*290\*280mm  
 Weight - 12kg

Pallet Dimensions 1200\*1000\*1320mm  
 48 Cartons per Pallet  
 12 Cartons per layer  
 4 Layers

