

ISP2080

Data Sheet



BLE 5.2 Audio Demo

This small audio demonstrator provides an example of the tremendous capabilities of the ISP2053 module based on nRF5340 Chip. With a powerful Cortex™ M33 CPU, flash and RAM memory combined with an optimized antenna, ISP2053 offers the best-in-class Bluetooth 5.2 performance and low power consumption.

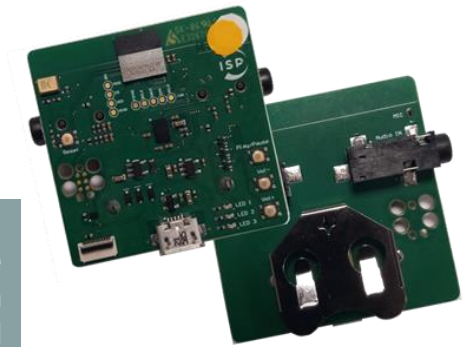

Key Features

- Bluetooth v5.2 - 2.4GHz low energy RF Transceiver
- Based on Insight SiP 2053-AX Module
- Dual ARM Cortex M33
- Fully integrated RF matching and Antenna
- Integrated 32 MHz and 32.768 kHz Clocks
- Audio codec
- Programmable buttons and LEDs
- USB port interface
- Power supply on coin cell battery CR2032 or with USB interface
- Overall Size 40 x 40 mm²
- Temperature -25 to 85 °C

Applications

- Sport and fitness sensors
- Health care sensors
- Industrial sensors
- Gaming sensors
- Motion detection and transmission

Certifications

- FCC certification
- CE certification
- IC certification
- TELEC certification
- Bluetooth SIG certification
- RoHS compliant



Document Revision History

Revision	Date	Ref	Change Description
R0	05/01/2023	jf pg	Initial release

Contents

1.	Block Diagram & Features	4
2.	Specifications	5
2.1.	RF Specification.....	5
2.2.	Audio Specification.....	5
3.	Electrical Schematic	6
3.1.	MCU & Connector.....	6
3.2.	Power Supply & Debug.....	7
3.3.	Audio In and Out.....	8
3.4.	HW Codec.....	8
4.	Product Development Tools	9
4.1.	Hardware.....	9
4.2.	Firmware.....	9

1. Block Diagram & Features

ISP2080 is an autonomous low-power device for wireless audio transmission. Overall size of the device is 40 x 40 mm².

The complete device makes use of Insight SiP ISP2053-AX BT5.2 module together with a microphone, Audio codec and Jack connectors powered by a button cell battery CR2032 or by USB.

The host processor that handles the autonomous application, and the communication with the audio codec is a low power 32-bit MCU (ARM Cortex-M33 based), integrating 1 MB Flash memory and 512 KB RAM. The BLE stack is handled by a coprocessor (also ARM Cortex-M33 based), integrating 256 KB Flash memory and 64 KB RAM.

The Audio Codec CS47L63 is used to:

- Convert analog audio from the "Audio IN" Jack connector to digital audio (I2S)
- Convert digital audio (I2S) to analog audio for the "Audio OUT" Jack connector.
- Convert digital audio (PDM) from the VM3011 to digital audio (I2S).

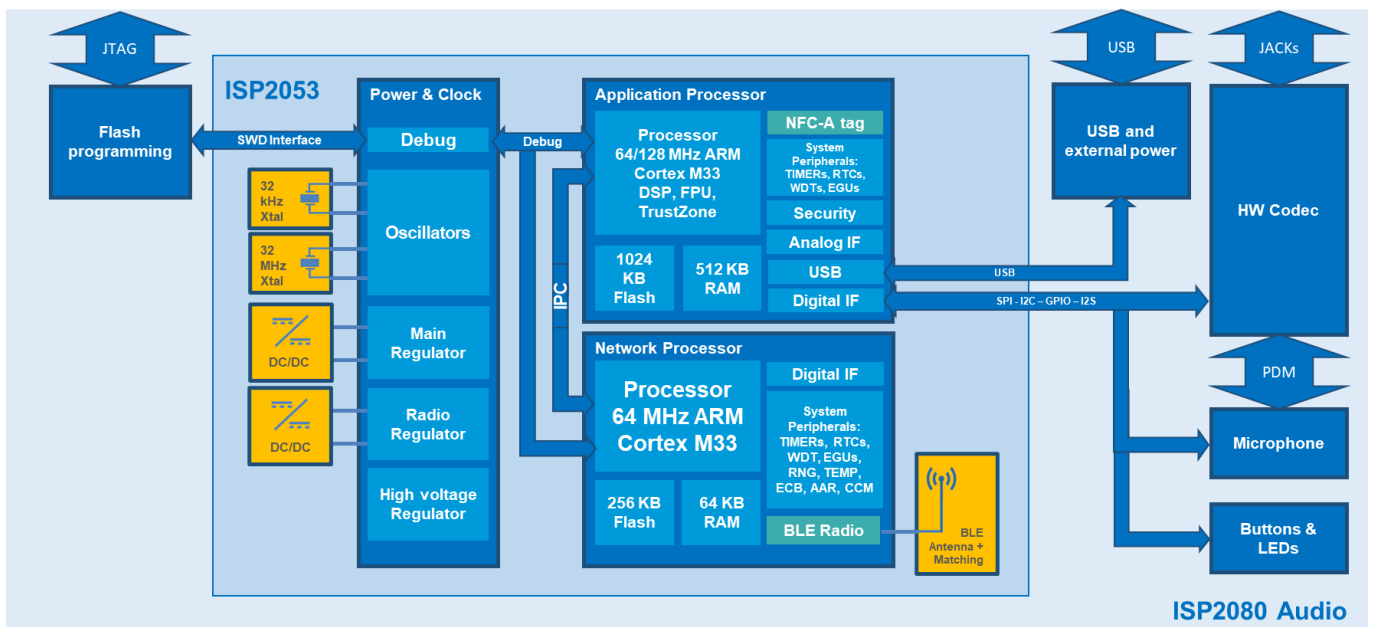

2. Specifications

2.1. RF Specification

The performance of Bluetooth 5.2 radio is related to ISP2053-AX specification.

Parameter	Min	Typ	Max	Unit
Frequency Range	2360		2500	MHz
Maximum Output Power			+3	dBm
Rx Sensitivity Level, BLE1 Mbps		-98		dBm
Rx Sensitivity Level, BLE Long Range 125 kbps		-104		dBm
Antenna Gain		0.6		dBi
EIRP	-19.4		3.6	dBm
Data Rate	125		2000	kbps

2.2. Audio Specification

The performance of the audio is related to CS47L63 specification.

Parameter	Min	Typ	Max	Unit
Analog input resistance	9	10.5		kΩ
Analog input capacitance			5	pF
Analog input programmable gain	0		29	dB
Headphone output resistance	15		100	Ω
Headphone output capacitance			100	pF
Headphone maximum output			1	Vrms

3.2. Power Supply & Debug

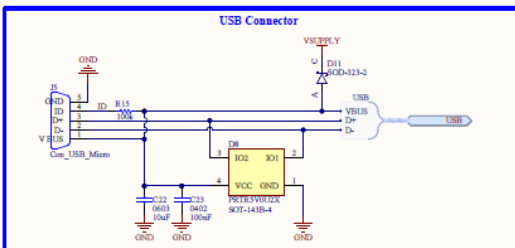
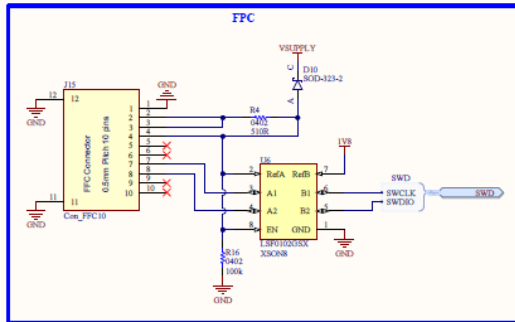
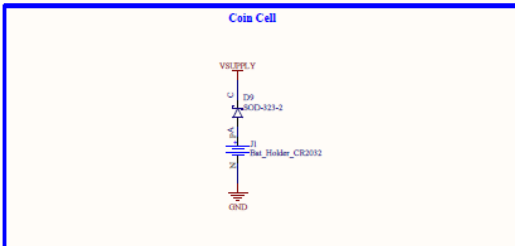
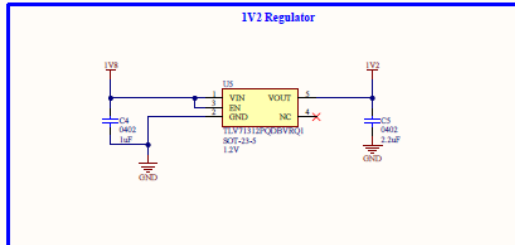
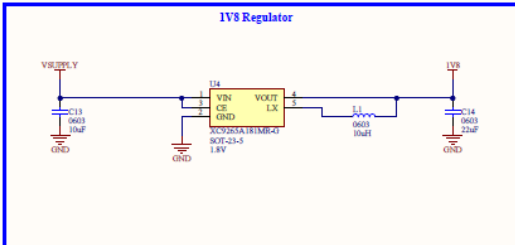

3.3. Audio In and Out

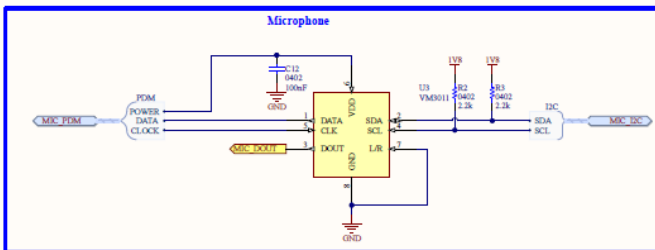
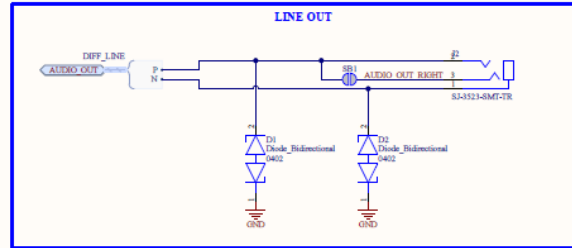
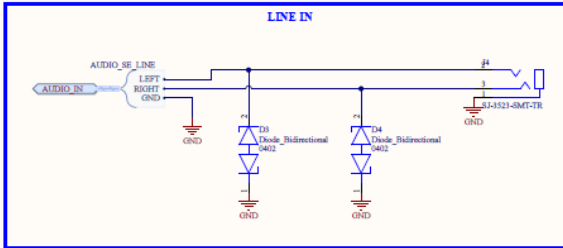

3.4. HW Codec

