

# XPT IGBT

tentative

$$V_{CES} = 1200V$$

$$I_{C25} = 43A$$

$$V_{CE(sat)} = 1.8V$$

ISOPLUS™ Surface Mount Power Device  
 Boost Topology  
 XPT IGBT

Part number

**IXA30RG1200DHGLB**



Backside: isolated

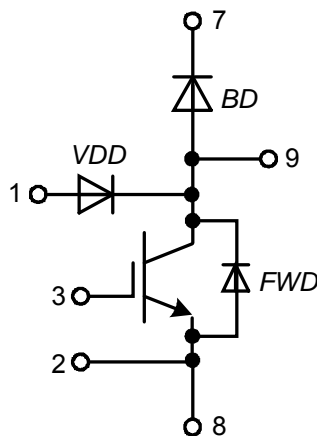
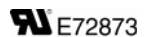

### Features / Advantages:

- XPT IGBT
  - low saturation voltage
  - positive temperature coefficient for easy paralleling
  - fast switching
  - short tail current for optimized performance in resonant circuits
- Sonic™ diode
  - fast reverse recovery
  - low operating forward voltage
  - low leakage current
  - low temperature dependency of reverse recovery
- Vcesat detection diode (VDD)
  - integrated into package
  - very fast diode

### Applications:

- AC drives
  - brake chopper
- PFC
  - boost chopper
- Switched reluctance drives

### Package: SMPD

- Industry convenient outline
- RoHS compliant
- Epoxy meets UL 94V-0
- Soldering pins for PCB mounting
- Backside: DCB ceramic
- Reduced weight
- Advanced power cycling
- Isolation Voltage: 3000 V~

Free Wheeling Diode FWD				Ratings			
Symbol	Definition	Conditions	min.	typ.	max.	Unit	
$V_{RSM}$	max. non-repetitive reverse blocking voltage	$T_{VJ} = 25^{\circ}C$			1200	V	
$V_{RRM}$	max. repetitive reverse blocking voltage	$T_{VJ} = 25^{\circ}C$			1200	V	
$I_R$	reverse current, drain current	$V_R = 1200 V$	$T_{VJ} = 25^{\circ}C$		30	$\mu A$	
		$V_R = 1200 V$	$T_{VJ} = 125^{\circ}C$		0.5	mA	
$V_F$	forward voltage drop	$I_F = 30 A$	$T_{VJ} = 25^{\circ}C$		2.20	V	
		$I_F = 60 A$				V	
		$I_F = 30 A$	$T_{VJ} = 125^{\circ}C$		2.20	V	
		$I_F = 60 A$				V	
$I_{FAV}$	average forward current	$T_C = 80^{\circ}C$ rectangular $d = 0.5$	$T_{VJ} = 150^{\circ}C$		25	A	
$V_{FO}$	threshold voltage	} for power loss calculation only	$T_{VJ} = 150^{\circ}C$		1.26	V	
$r_F$	slope resistance				28	m $\Omega$	
$R_{thJC}$	thermal resistance junction to case				1	K/W	
$R_{thCH}$	thermal resistance case to heatsink			0.30		K/W	
$P_{tot}$	total power dissipation		$T_C = 25^{\circ}C$		125	W	
$I_{FSM}$	max. forward surge current	$t = 10 ms; (50 Hz), sine; V_R = 0 V$	$T_{VJ} = 45^{\circ}C$		200	A	
$C_J$	junction capacitance	$V_R = 400 V f = 1 MHz$	$T_{VJ} = 25^{\circ}C$		13	pF	

VCEsat Detection Diode VDD				Ratings			
Symbol	Definition	Conditions	min.	typ.	max.	Unit	
$V_{RRM}$	max. repetitive reverse blocking voltage	$T_{VJ} = 25^{\circ}C$			1200	V	
$I_R$	reverse current, drain current	$V_{R/D} = 1200 V$	$T_{VJ} = 25^{\circ}C$		2	$\mu A$	
		$V_{R/D} = 1200 V$	$T_{VJ} = 125^{\circ}C$		0.03	mA	
$V_F$	forward voltage drop	$I_F = 1 A$	$T_{VJ} = 25^{\circ}C$		2.20	V	
		$I_F = 1 A$	$T_{VJ} = 125^{\circ}C$		1.80	V	
$V_{FO}$	threshold voltage	} for power loss calculation only	$T_{VJ} = 150^{\circ}C$		1.30	V	
$r_F$	slope resistance				390	m $\Omega$	
$C_J$	junction capacitance	$V_R = 400 V; f = 1 MHz$	$T_{VJ} = 25^{\circ}C$		tbd	pF	
$I_{RM}$	max. reverse recovery current	} $V_R = 100 V; I_F = 1 A$ $-di/dt = 100 A/\mu s$	$T_{VJ} = 25^{\circ}C$		2.3	A	
$t_{rr}$	reverse recovery time		$T_{VJ} = 125^{\circ}C$		tbd	A	
			$T_{VJ} = 25^{\circ}C$		40	ns	
			$T_{VJ} = 125^{\circ}C$		tbd	ns	

Boost IGBT				Ratings			
Symbol	Definition	Conditions	min.	typ.	max.	Unit	
$V_{CES}$	collector emitter voltage	$T_{VJ} = 25^{\circ}\text{C}$			1200	V	
$V_{GES}$	max. DC gate voltage				$\pm 20$	V	
$V_{GEM}$	max. transient collector gate voltage				$\pm 30$	V	
$I_{C25}$	collector current	$T_C = 25^{\circ}\text{C}$			43	A	
$I_{C80}$		$T_C = 80^{\circ}\text{C}$			30	A	
$P_{tot}$	total power dissipation	$T_C = 25^{\circ}\text{C}$			147	W	
$V_{CE(sat)}$	collector emitter saturation voltage	$I_C = 25\text{ A}; V_{GE} = 15\text{ V}$			1.8	V	
					2.1	V	
$V_{GE(th)}$	gate emitter threshold voltage	$I_C = 1\text{ mA}; V_{CE} = V_{CE}$	5.4	5.9	6.5	V	
$I_{CES}$	collector emitter leakage current	$V_{CE} = V_{CES}; V_{GE} = 0\text{ V}$			0.1	mA	
					0.1	mA	
$I_{GES}$	gate emitter leakage current	$V_{GE} = \pm 20\text{ V}$			500	nA	
$Q_{G(on)}$	total gate charge	$V_{CE} = 600\text{ V}; V_{GE} = 15\text{ V}; I_C = 25\text{ A}$		76		nC	
$t_{d(on)}$	turn-on delay time	inductive load $V_{CE} = 600\text{ V}; I_C = 25\text{ A}$ $V_{GE} = \pm 15\text{ V}; R_G = 39\ \Omega$					
$t_r$	current rise time						
$t_{d(off)}$	turn-off delay time						
$t_f$	current fall time						
$E_{on}$	turn-on energy per pulse						
$E_{off}$	turn-off energy per pulse						
$R_{BSOA}$	reverse bias safe operating area	$V_{GE} = \pm 15\text{ V}; R_G = 39\ \Omega$					
$I_{CM}$		$V_{CEmax} = 1200\text{ V}$			75	A	
$R_{SCSOA}$	short circuit safe operating area	$V_{CEmax} = 1200\text{ V}$					
$t_{sc}$	short circuit duration	$V_{CE} = 900\text{ V}; V_{GE} = \pm 15\text{ V}$			10	$\mu\text{s}$	
$I_{sc}$	short circuit current	$R_G = 39\ \Omega; \text{non-repetitive}$			100	A	
$R_{thJC}$	thermal resistance junction to case				0.85	K/W	
$R_{thCH}$	thermal resistance case to heatsink				0.25	K/W	
<b>Boost Diode BD</b>							
$V_{RRM}$	max. repetitive reverse voltage	$T_{VJ} = 25^{\circ}\text{C}$			1200	V	
$I_{F25}$	forward current	$T_C = 25^{\circ}\text{C}$			48	A	
$I_{F80}$		$T_C = 80^{\circ}\text{C}$			32	A	
$V_F$	forward voltage	$I_F = 30\text{ A}$			2.20	V	
					1.90	V	
$I_R$	reverse current	$V_R = V_{RRM}$			0.03	mA	
					0.15	mA	
$Q_{rr}$	reverse recovery charge	$V_R = 600\text{ V}$ $-di_F/dt = 600\text{ A}/\mu\text{s}$ $I_F = 30\text{ A}; V_{GE} = 0\text{ V}$					
$I_{RM}$	max. reverse recovery current						
$t_{rr}$	reverse recovery time						
$E_{rec}$	reverse recovery energy						
$R_{thJC}$	thermal resistance junction to case				1	K/W	
$R_{thCH}$	thermal resistance case to heatsink				0.3	K/W	

tentative

Package SMPD		Ratings				
Symbol	Definition	Conditions	min.	typ.	max.	Unit
$I_{RMS}$	RMS current	per terminal			100	A
$T_{stg}$	storage temperature		-55		150	°C
$T_{vj}$	virtual junction temperature		-55		150	°C
<b>Weight</b>				8.5		g
$F_C$	mounting force with clip		40		130	N
$V_{ISOL}$	isolation voltage	t = 1 second	3000			V
		t = 1 minute	2500			V
$d_{Spp/App}$	creepage distance on surface   striking distance through air	terminal to terminal	1.6			mm
		terminal to backside	4.0			mm



### Part number

- I = IGBT
- X = XPT IGBT
- A = Gen 1 / std
- 30 = Current Rating [A]
- RG = boost configuration
- 1200 = Reverse Voltage [V]
- D = IGBT
- H = XPT IGBT
- G = Gen 1 / std
- LB = SMPD-B

Ordering	Part Number	Marking on Product	Delivery Mode	Quantity	Code No.
Standard	IXA30RG1200DHGLB	IXA30RG1200DHGLB	Blister	45	512356
Alternative	IXA30RG1200DHGLB-TRR	IXA30RG1200DHGLB	Tape & Reel	200	511654

Similar Part	Package	Voltage class
IXA20RG1200DHGLB	SMPD-B	1200
IXA40RG1200DHGLB	SMPD-B	1200

**Outlines SMPD**

**A ( 8 : 1 )**



## Boost IGBT

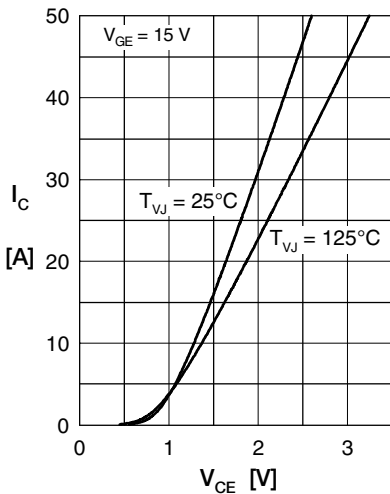

Fig. 1 Typ. output characteristics

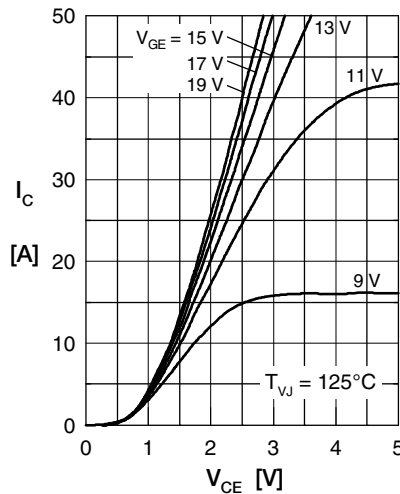

Fig. 2 Typ. output characteristics

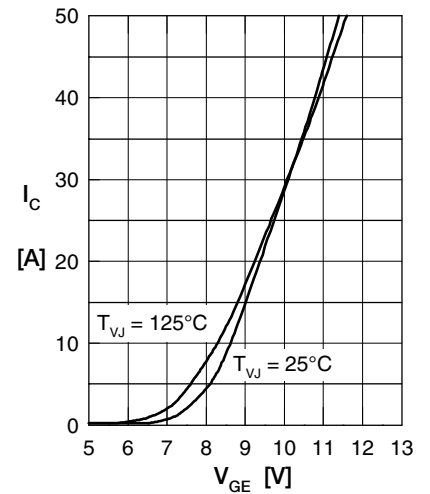

Fig. 3 Typ. transfer characteristics

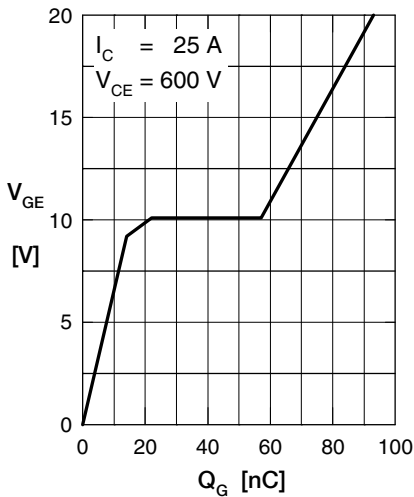

Fig. 4 Typ. turn-on gate charge

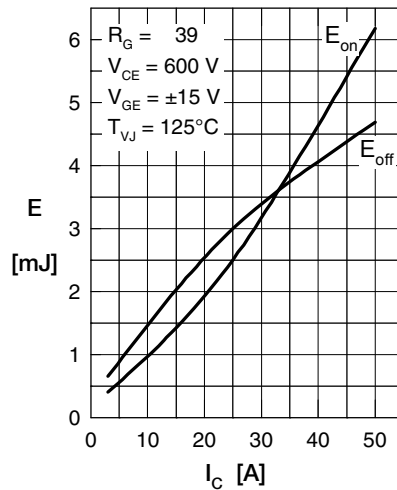

Fig. 5 Typ. switching energy versus collector current

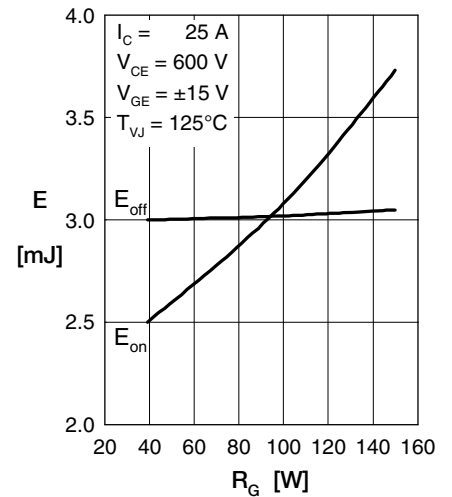

Fig. 6 Typ. switching energy versus gate resistance

Fig. 7 Typ. transient thermal impedance junction to case

## Boost Diode BD

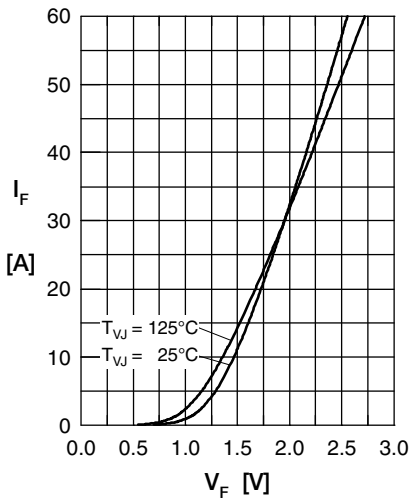

Fig. 1 Typ. Forward current versus  $V_F$

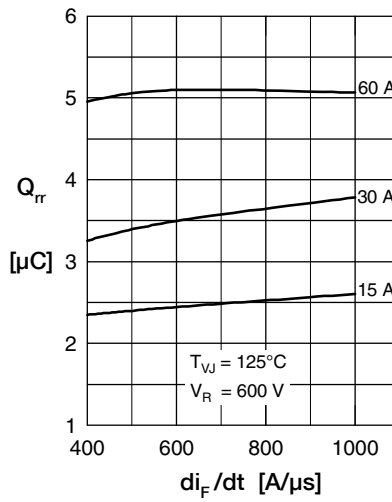

Fig. 2 Typ. reverse recov.charge  $Q_{rr}$  versus  $di/dt$

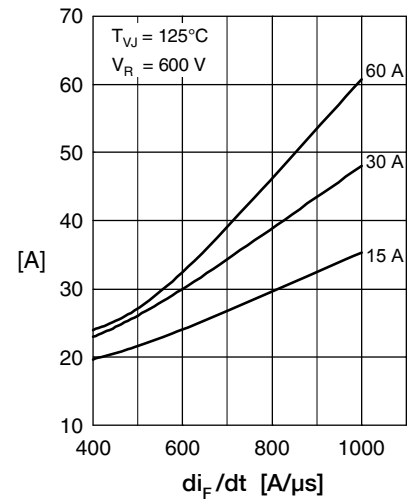

Fig. 3 Typ. peak reverse current  $I_{RM}$  versus  $di/dt$

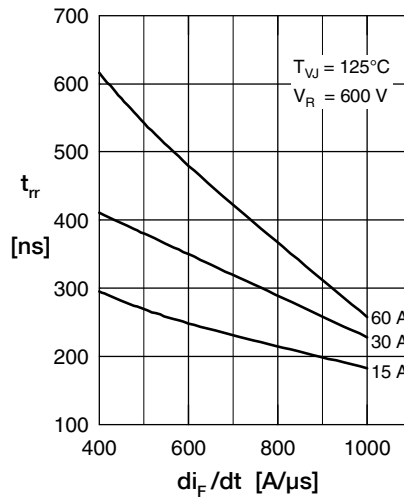

Fig. 4 Dynamic parameters  $Q_{rr}$ ,  $I_{RM}$  versus  $di/dt$

Fig. 5 Typ. recovery time  $t_{rr}$  versus  $di/dt$

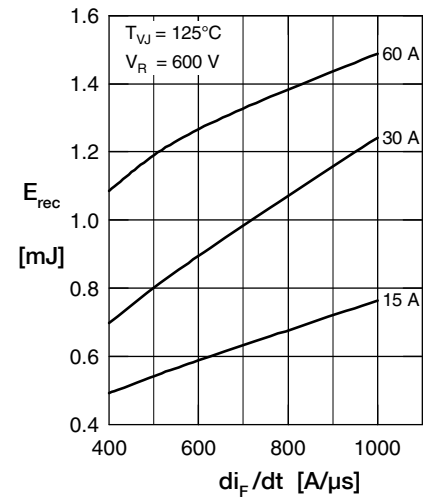

Fig. 6 Typ. recovery energy  $E_{rec}$  versus  $di/dt$

Fig. 7 Typ. transient thermal impedance junction to case