

## High Speed Dual LDO Regulator with ON/OFF Switch

### FEATURES

- Output Current up to 300 mA (450 mA max)
- Dropout Voltage 210 mV @  $I_{OUT} = 300$  mA,  $V_{OUT} = 3.0$  V
- Operating Voltage Range 1.6 V – 5.5 V
- Output Voltage Range from 1.2 V to 3.6 V with 0.05 V increments
- Output Voltage Accuracy  $\pm 1\%$  @  $V_{OUT} \geq 2.0$  V or  $\pm 20$  mV @  $V_{OUT} \leq 1.95$  V
- Low Power Consumption at 90  $\mu$ A per channel
- Standby Current less than 0.1  $\mu$ A typical
- PSRR at 75 dB for  $f = 1$  kHz
- ON/OFF switch for each channel
- Current Limit, and Short Circuit Protection
- Load Capacitor Auto Discharge
- Thermal shutdown
- Low ESR Ceramic Capacitor compatible
- Operating Ambient Temperature - 40 + 85°C
- Package : USP-6C
- EU RoHS Compliant, Pb Free

### APPLICATIONS

- Mobile phones
- Cameras, VCRs
- Various portable equipment

### DESCRIPTION

The IXD1421 is a highly accurate, CMOS dual output LDO high-speed voltage regulator with high ripple rejection ratio, and low dropout. It allows create extremely dense power supply circuit with two high-

speed voltage regulators in an ultra small USP-6C package.

The IC consists of two identical circuits, each of which contains reference voltage source, an error amplifier, a phase compensation circuit, a driver transistor, an inrush current, over-current and thermal shutdown protections, and a load capacitor's discharge switch.

The output voltage for each regulator sets independently by laser trimming, and it is selectable in 0.05 V increments within a range from 1.2 to 3.6 V.

The enable (EN) function allows set each channel into standby mode independently, reducing current consumption to less than 0.1  $\mu$ A and simultaneously discharging load capacitor through the internal auto-discharge switch located between  $V_{OUT}$  and  $V_{SS}$  pins, setting quickly the  $V_{OUT}$  pin voltage to the  $V_{SS}$  level.

The internal phase compensation allows the IXD1421 operate with a low ESR ceramic output capacitor  $C_L$ . The excellent transient response maintains high level of output stability even during frequent load fluctuations.

The over current protection circuit (the current limiter and the fold back circuit), as well as inrush current and thermal protections are built-in.

A cross talk between channels, which causes a problem during load fluctuations, is greatly reduced, because both regulators are completely isolated.

The IXD1421 is available in USP-6C package.

### TYPICAL APPLICATION CIRCUIT

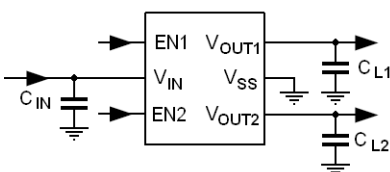

### TYPICAL PERFORMANCE CHARACTERISTIC

**PSRR**  
**IXD1421 ( $V_{OUT} = 1.8$  V)**  
 $V_{IN} = 3.0$  V<sub>DC</sub> + 0.5 V<sub>p-PAC</sub>,  $T_a = 25$  °C,  $C_{IN} = C_{L1} = C_{L2} = 1$   $\mu$ F

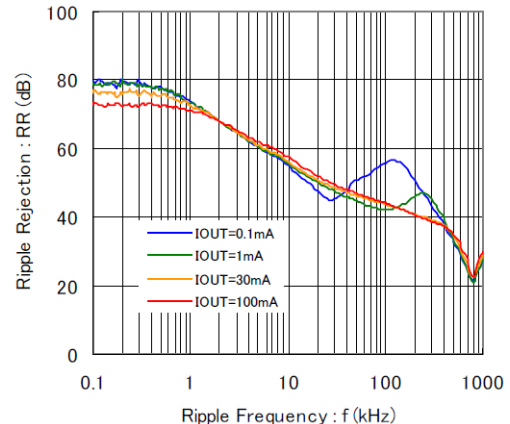

## ABSOLUTE MAXIMUM RATINGS

PARAMETER		SYMBOL	RATINGS	UNITS
Input Voltage		$V_{IN}$	- 0.3 ~ +7.0	V
Output Current		$I_{OUT1} + I_{OUT2}$	800 <sup>1)</sup>	mA
Output Voltage1/2		$V_{OUT1}/ V_{OUT2}$	- 0.3 ~ $V_{IN} + 0.3$ or 7.0	V
EN1/EN2 Input Voltage		$V_{EN1}/ V_{EN2}$	- 0.3 ~ +7.0	V
Power Dissipation <sup>2)</sup>	USP-6C	$P_D$	100	mW
			1000 (PCB mounted)	
Operating Temperature Range		$T_{OPR}$	- 40 ~ + 85	°C
Storage Temperature Range		$T_{STG}$	- 55 ~ +125	°C

All voltages are in respect to  $V_{SS}$

- 1) Maximum current is limited by Power Dissipation as  $P_d \geq (V_{IN}-V_{OUT1}) \times I_{OUT1} + (V_{IN}-V_{OUT2}) \times I_{OUT2}$
- 2) This is a reference data taken by using the test board. Please refer to page 19 for details

## ELECTRICAL OPERATING CHARACTERISTICS

Regulator1, Regulator 2

$T_a = 25^\circ\text{C}$

PARAMETER	SYMBOL	CONDITIONS	MIN.	TYP.	MAX.	UNIT	CIRCUIT
Input Voltage	$V_{IN}$		1.6		5.5	V	①
Output Voltage	$V_{OUT(E)}^{1)}$	$V_{IN} = V_{EN}, I_{OUT} = 10 \text{ mA}, V_{OUT(T)} \geq 2.0 \text{ V}$	$V_{OUT(T)} \times 0.99$	$V_{OUT(T)}^{2)}$	$V_{OUT(T)} \times 1.01$	V	①
		$V_{IN} = V_{EN}, I_{OUT} = 10 \text{ mA}, V_{OUT(T)} < 2.0 \text{ V}$	$V_{OUT(T)} - 0.02$		$V_{OUT(T)} + 0.02$		
Maximum Output Current	$I_{OUT\_MAX1}$		300			mA	①
Load Regulation	$\Delta V_{OUT}$	$V_{IN} = V_{EN}, 0.1 \text{ mA} \leq I_{OUT} \leq 300 \text{ mA}$		25	45	mV	①
Dropout Voltage <sup>3)</sup>	$V_{DIF1}$	$V_{IN} = V_{EN}, I_{OUT} = 300 \text{ mA}$	See Table Voltage Chart			mV	①
Supply Current	$I_{IN}$	$I_{OUT} = 0, V_{IN} = V_{EN}$		90	190	µA	①
Standby Current	$I_{IN\_STB}$	$V_{EN} = 0 \text{ V}$		0.01	0.10	µA	
Input Line Regulation	$\frac{\Delta V_{OUT}}{V_{OUT} * \Delta V_{IN}}$	$V_{IN} = V_{EN}, I_{OUT} = 30 \text{ mA}$	$V_{OUT(T)} + 0.5 \leq V_{IN} \leq 5.5 \text{ V}, V_{OUT(T)} \geq 2.05 \text{ V}$	0.02	0.10	%V	①
			$2.5 \leq V_{IN} \leq 5.5 \text{ V}, V_{OUT(T)} \leq 2.0 \text{ V}$				
Output Voltage Thermal Stability	$\frac{\Delta V_{OUT}}{\Delta T * \Delta V_{OUT}}$	$V_{IN} = V_{EN}, I_{OUT} = 10 \text{ mA}$ $-40^\circ\text{C} \leq T_a \leq 85^\circ\text{C}$		±100		ppm/°C	
Power Supply Ripple Rejection	PSRR	$V_{IN} = V_{OUT(T)} + 1.0 \text{ V}_{DC} + 0.5 \text{ V}_{p-pAC}, V_{OUT(T)} \leq 4.75 \text{ V}, I_{OUT} = 30 \text{ mA}, f = 1 \text{ kHz}$		75		dB	②
Current Limit	$I_{LIM}$	$V_{IN} = V_{EN}$	310	450		mA	①
Short Circuit Current	$I_{SHORT}$	$V_{IN} = V_{EN}, V_{OUT} = 0 \text{ V}$		125		mA	①
$C_L$ Discharge Resistance	$R_{DCH}$	$V_{IN} = 5.5 \text{ V}, V_{EN} = 0 \text{ V}, V_{OUT} = 2.0 \text{ V}$		230		Ω	①
EN "H" Level Voltage	$V_{CEH}$		1.0		$V_{IN}$	V	①
EN "L" Level Voltage	$V_{CEL}$		0		0.3	V	①
EN "H" Level Current	$I_{CEH}$	$V_{IN} = V_{EN} = 5.5 \text{ V}$	2.9	6.0	9.5	µA	①
EN "L" Level Current	$I_{CEL}$	$V_{EN} = 0 \text{ V}$	-0.1		0.1	µA	①
Inrush Current	$I_{INR}$			150		mA	
Thermal Shutdown Threshold	$T_{TSD}$	Junction Temperature		150		°C	
Thermal Shutdown Hysteresis	$T_H$	Junction Temperature		25		°C	

### NOTE:

Unless otherwise stated  $V_{IN} = V_{OUT(T)} + 1.0 \text{ V}$ ,

- 1)  $V_{OUT(E)}$  is an Effective output voltage
- 2)  $V_{OUT(T)}$  is a Nominal output voltage

- 3)  $V_{dif} = V_{IN1} - V_{OUT1}$ , where  $V_{IN1}$  is an input voltage, which is enough to keep  $V_{OUT} = V_{OUT(E)} \times 0.98$  with stable  $I_{OUT}$ .

## ELECTRICAL OPERATING CHARACTERISTICS (CONTINUED)

### Voltage Chart

NOMINAL OUTPUT VOLTAGE (V)	OUTPUT VOLTAGE (V)		DROPOUT VOLTAGE (mV)	
	$V_{OUT(E)}$		Vdif	
	MIN.	MAX.	TYP.	MIN.
1.200	1.1800	1.2200	580	680
1.250	1.2300	1.2700		
1.300	1.2800	1.3200	515	610
1.350	1.3300	1.3700		
1.400	1.3800	1.4200	460	550
1.450	1.4300	1.4700		
1.500	1.4800	1.5200		
1.550	1.5300	1.5700		
1.600	1.5800	1.6200	380	450
1.650	1.6300	1.6700		
1.700	1.6800	1.7200		
1.750	1.7300	1.7700		
1.800	1.7800	1.8200	330	390
1.850	1.8300	1.8700		
1.900	1.8800	1.9200		
1.950	1.9300	1.9700		
2.000	1.9800	2.0200	295	350
2.050	2.0295	2.0705		
2.100	2.0790	2.1210		
2.150	2.1285	2.1715		
2.200	2.1780	2.2220		
2.250	2.2275	2.2725		
2.300	2.2770	2.3230		
2.350	2.3265	2.3735		
2.400	2.3760	2.4240		
2.450	2.4255	2.4745		

NOMINAL OUTPUT VOLTAGE (V)	OUTPUT VOLTAGE (V)		DROPOUT VOLTAGE (mV)	
	$V_{OUT(E)}$		Vdif	
	MIN.	MAX.	TYP.	MAX.
2.500	2.4750	2.5250	240	290
2.550	2.5245	2.5755		
2.600	2.5740	2.6260		
2.650	2.6235	2.6765		
2.700	2.6730	2.7270		
2.750	2.7225	2.7775		
2.800	2.7720	2.8280		
2.850	2.8215	2.8785		
2.900	2.8710	2.9290		
2.950	2.9205	2.9795		
3.000	2.9700	3.0300		
3.050	3.0195	3.0805		
3.100	3.0690	3.1310		
3.150	3.1185	3.1815		
3.200	3.1680	3.2320		
3.250	3.2175	3.2825		
3.300	3.2670	3.3330		
3.350	3.3165	3.3835		
3.400	3.3660	3.4340		
3.450	3.4155	3.4845		
3.500	3.4650	3.5350		
3.550	3.5145	3.5855		
3.600	3.5640	3.6360		

## PIN CONFIGURATION

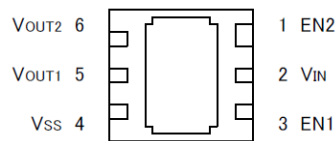

USP-6C (Bottom View)

The dissipation pad for the USP-6C package should be solder-plated in respect with mounting pattern and metal mask to improve heat dissipation and mounting strength. If the pad needs to be connected to other pins, it should be connected to the  $V_{SS}$  (No. 4) pin.

## PIN ASSIGNMENT

PIN NUMBER	PIN NAME	FUNCTIONS
1	EN2	ON/OFF Control2
2	$V_{IN}$	LDO Regulators Power Input
3	EN1	ON/OFF Control1
4	$V_{SS}$	Ground
5	$V_{OUT1}$	Output Voltage 1
6	$V_{OUT2}$	Output Voltage 2

## BLOCK DIAGRAM

IXD1421ABxxx-G

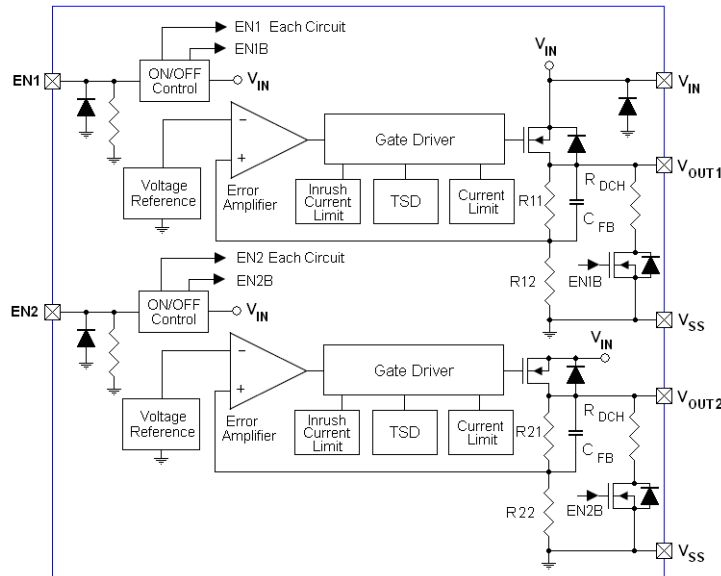

Diodes inside the circuits are ESD protection diodes and parasitic diodes.

## BASIC OPERATION

The Error Amplifier of the IXD1421 series monitors output voltage divided by internal resistors R1 & R2 and compares it with the internal Reference Voltage (see Block Diagram above). The output signal from error amplifier drives gate of the P-channel MOSFET, which is connected to the V<sub>OUT</sub> pin and operates as a series voltage regulator for V<sub>IN</sub> voltage.

The Current Limit/Short Protection circuits monitor level of the output current to prevent IC damage by excessive current, while Thermal Shutdown circuit monitors junction temperature to prevent thermal damage..

The EN pin allows shutdown internal circuitry to minimize power consumption by the unused channel.

### C<sub>L</sub> High-speed Discharge Function

The IXD1421 contains the N-channel transistor located between V<sub>OUT</sub> and V<sub>SS</sub> pins to discharge quickly the output capacitor (C<sub>L</sub>), when the EN pin does low. The discharge time of the output capacitor (C<sub>L</sub>) is set by the C<sub>L</sub> auto-discharge resistance R<sub>DCH</sub> = 230 Ω (TYP.) and the output capacitance (C<sub>L</sub>). The auto-discharge resistance R<sub>DCH</sub> depends on V<sub>IN</sub> voltage decreasing when V<sub>IN</sub> goes up.

Time constant  $\tau = C_L \times R_{DCH}$  determines the output voltage after discharge as

$$V = V_{OUT(E)} \times e^{-t/\tau}$$

Where: V<sub>OUT(E)</sub> - Output voltage, and t - Discharge time

Discharge time can be calculated also by the next formula:

$$t = \tau \times \ln(V_{OUT(E)}/V)$$

### Current Limiter, Short-Circuit Protection

The IXD1421 series include a combination of a fixed current limiter circuit and a fold back circuit, which aid the operations of the current limiter and circuit protection. When the load current reaches the current limit level, the fixed current limiter circuit activates and output voltage drops. Because of this drop, the fold back circuit activates too, and output voltage drops further decreasing output current. When the output pin is shorted, a current of about 125 mA flows.

## EN Pin

The EN pin allows shutdown internal circuitry to minimize power consumption. In shutdown mode, output at the  $V_{OUT}$  pin is pulled down to the  $V_{SS}$  level by  $R_{DCH}$  resistor and N-channel switch, as well as resistors R1 and R2 connected in series.

Note that the channel is active, when EN input is HIGH, and the IXD1421 has a pull down resistors at EN1/EN2 pins. Channel will be in off state, if EN pin is open.

EN pin current consumption may increase, if voltage applied to this pin is  $\sim 0.5$  of  $V_{IN}$ .

## Low ESR Capacitors

An internal phase compensation circuit guarantees stable IXD1421 operation with low ESR capacitors. However, connect the output capacitor  $C_L = 1.0 \mu F$  as close to the  $V_{OUT}$  of the each channel and the  $V_{SS}$  pins as possible, to not degrade its function. In addition, an input capacitor  $C_{IN} = 1.0 \mu F$  between the  $V_{IN}$  and  $V_{SS}$  pins should be used to ensure a stable input power.

## Thermal Shutdown

When the junction temperature of the built-in driver transistor reaches the temperature limit, the thermal shutdown circuit turns the driver transistor OFF. The IC resumes its operation automatically, when the junction temperature drops below the thermal shutdown release voltage.

## Inrush Current Protection

The inrush current protection circuit built in the IXD1421 limits the inrush current charging  $C_L$  capacitor at 150mA during channel's start-up.

## TYPICAL APPLICATION CIRCUIT

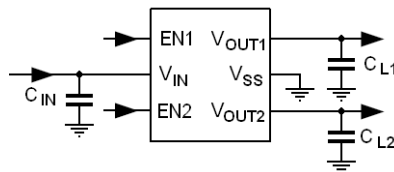

## LAYOUT AND USE CONSIDERATIONS

1. Mount external component as close to the IC as possible and use thick, short connecting traces to reduce the circuit impedance.
2. The IC may malfunction if absolute maximum ratings are exceeded.
3. Please ensure that output current is limited by package power dissipation and  $P_D \geq ((V_{IN} - V_{OUT1}) \times I_{OUT1} + ((V_{IN} - V_{OUT2}) \times I_{OUT2})$ , where  $P_D$  is a rated power dissipation value of the package shown at ABSOLUTE MAXIMUM RATING table.

## TEST CIRCUITS

Circuit ①

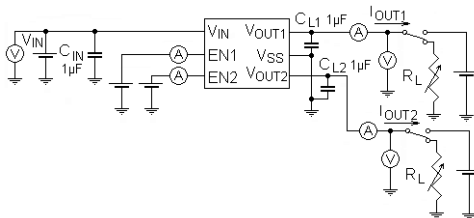

Circuit ②

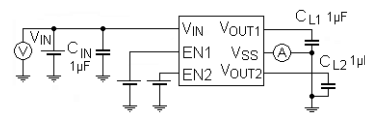

Circuit ③

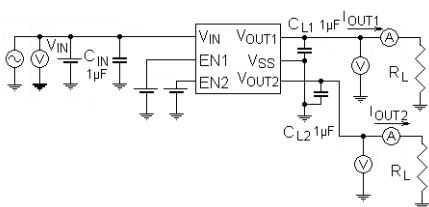

Unless otherwise stated,  $T_a = 25^\circ C$ ,  $V_{IN} = V_{EN}$ ,  $C_{IN} = C_L = 1.0 \mu F$

## TYPICAL PERFORMANCE CHARACTERISTICS

### (1) Output Voltage vs. Output Current

#### IXD1421

$V_{in} = 2.2\text{ V}$ ,  $V_{out} = 1.2\text{ V}$

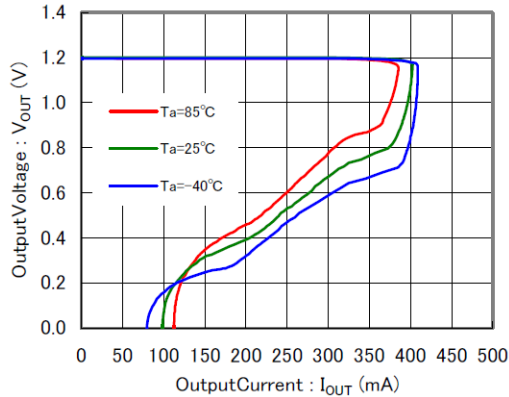

#### IXD1421

$V_{out} = 1.2\text{ V}$ ,  $T_a = 25^\circ\text{C}$

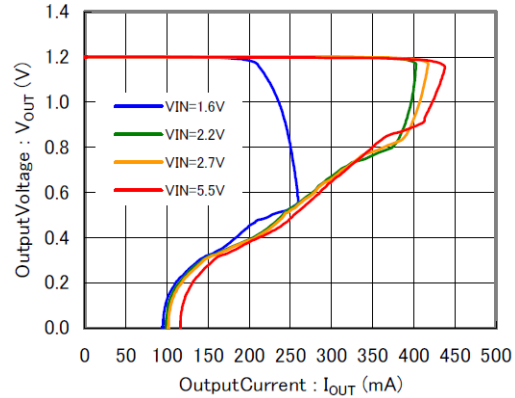

#### IXD1421

$V_{in} = 2.8\text{ V}$ ,  $V_{out} = 1.8\text{ V}$

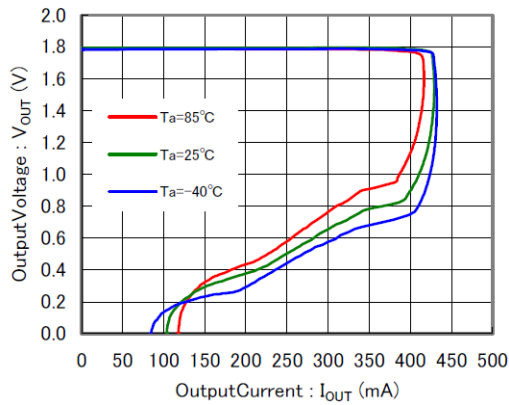

#### IXD1421

$V_{out} = 1.8\text{ V}$ ,  $T_a = 25^\circ\text{C}$

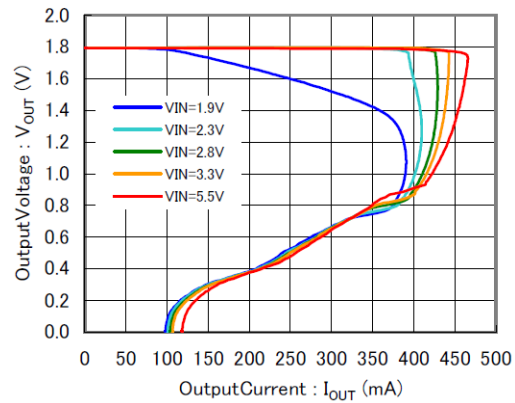

#### IXD1421

$V_{in} = 3.5\text{ V}$ ,  $V_{out} = 2.5\text{ V}$

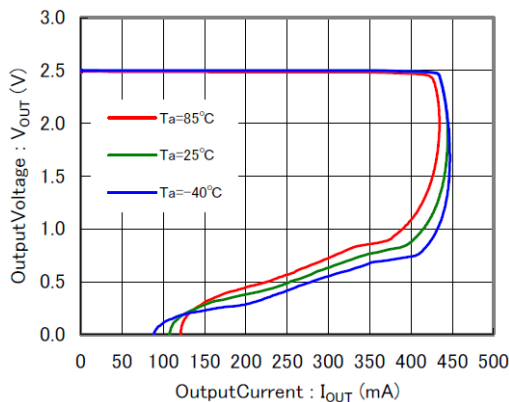

#### IXD1421

$V_{out} = 2.5\text{ V}$ ,  $T_a = 25^\circ\text{C}$

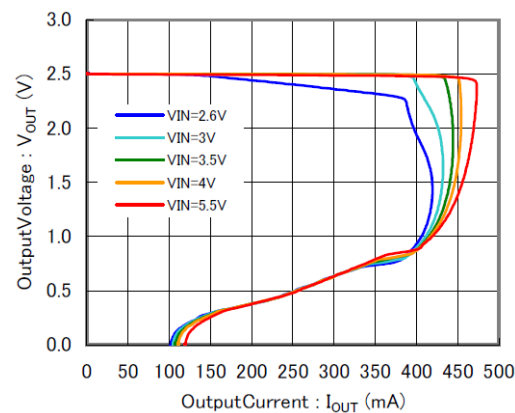

## TYPICAL PERFORMANCE CHARACTERISTICS (Continued)

### (1) Output Voltage vs. Output Current (Continued)

#### IXD1421

$V_{IN} = 4.6\text{ V}$ ,  $V_{OUT} = 3.6\text{ V}$

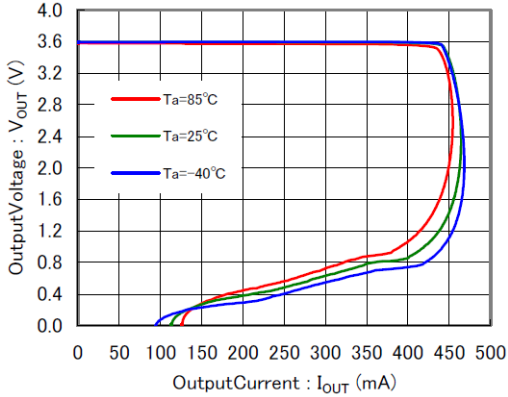

#### IXD1421

$V_{OUT} = 3.6\text{ V}$ ,  $T_a = 25^\circ\text{C}$

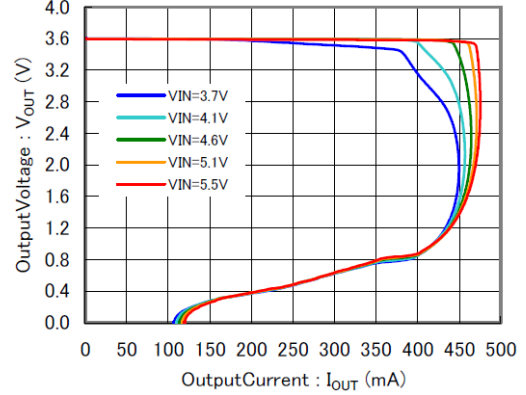

### (2) Output Voltage vs. Input Voltage

#### IXD1421

$V_{OUT} = 1.2\text{ V}$ ,  $T_a = 25^\circ\text{C}$

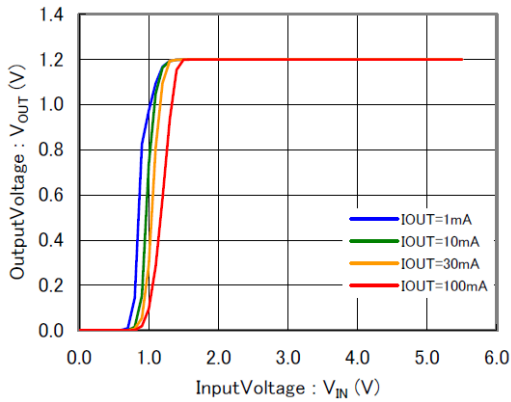

#### IXD1421

$V_{OUT} = 1.2\text{ V}$ ,  $T_a = 25^\circ\text{C}$

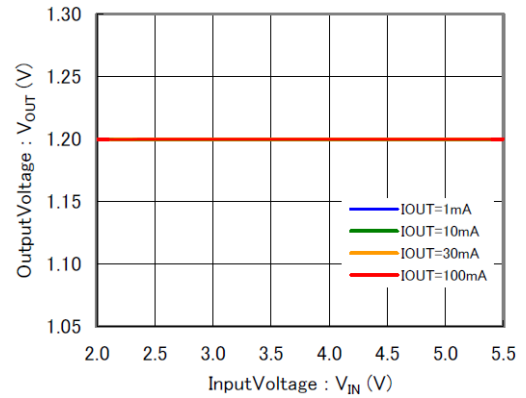

#### IXD1421

$V_{OUT} = 1.8\text{ V}$ ,  $T_a = 25^\circ\text{C}$

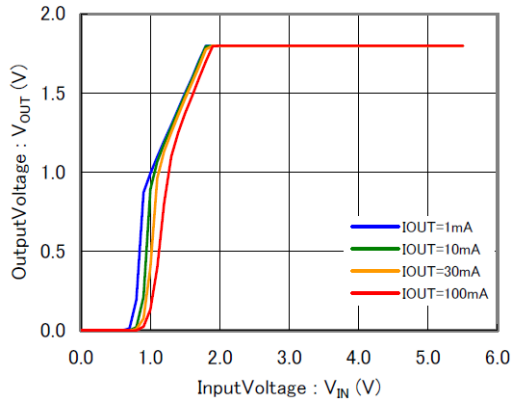

#### IXD1421

$V_{OUT} = 1.8\text{ V}$ ,  $T_a = 25^\circ\text{C}$

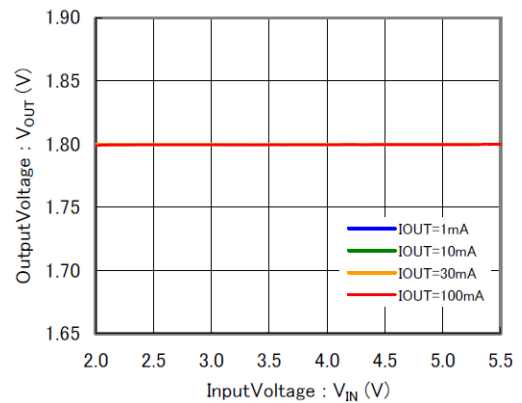

## TYPICAL PERFORMANCE CHARACTERISTICS (Continued)

### (2) Output Voltage vs. Input Voltage (Continued)

#### IXD1421

$V_{OUT} = 2.5\text{ V}$ ,  $T_a = 25^\circ\text{C}$

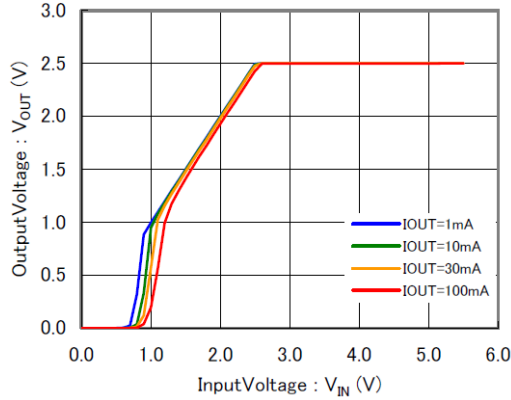

#### IXD1421

$V_{OUT} = 2.5\text{ V}$ ,  $T_a = 25^\circ\text{C}$

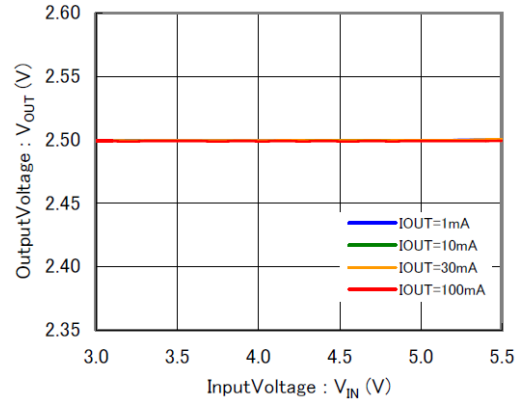

#### IXD1421

$V_{OUT} = 3.6\text{ V}$ ,  $T_a = 25^\circ\text{C}$

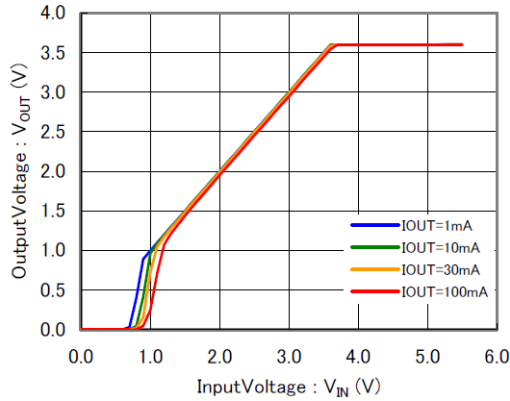

#### IXD1421

$V_{OUT} = 3.6\text{ V}$ ,  $T_a = 25^\circ\text{C}$

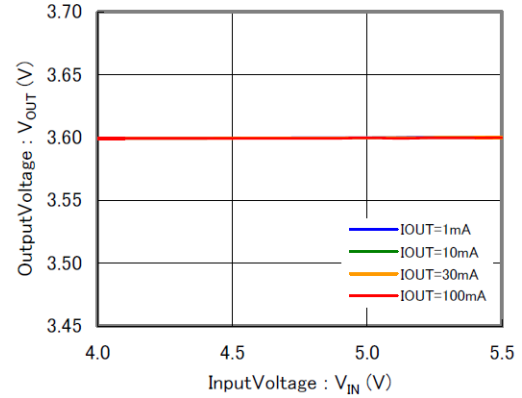

### (3) Dropout Voltage vs. Output Current

#### IXD1421

$V_{OUT} = 1.2\text{ V}$

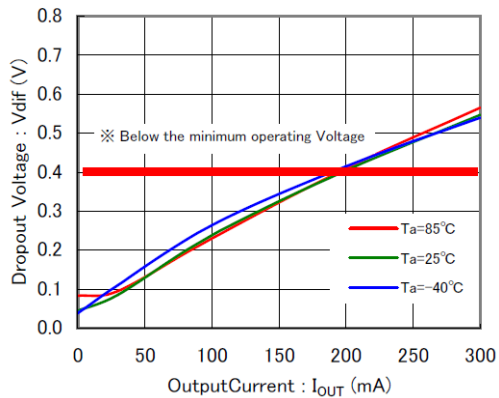

#### IXD1421

$V_{OUT} = 1.8\text{ V}$

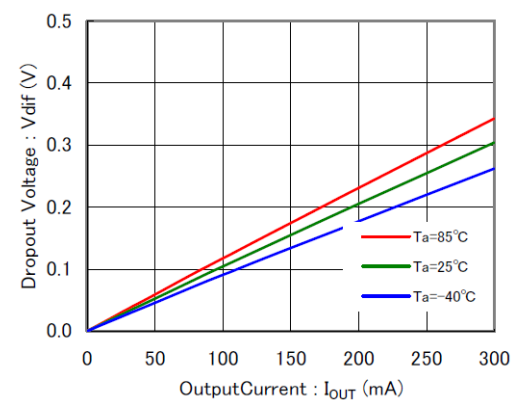



## TYPICAL PERFORMANCE CHARACTERISTICS (Continued)

### (3) Dropout Voltage vs. Output Current (Continued)

**IXD1421**

$V_{OUT} = 2.5\text{ V}$

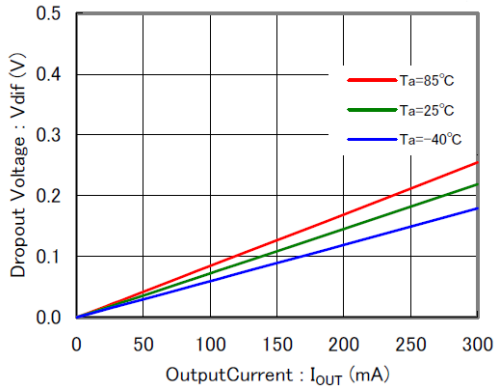

**IXD1421**

$V_{OUT} = 3.6\text{ V}$

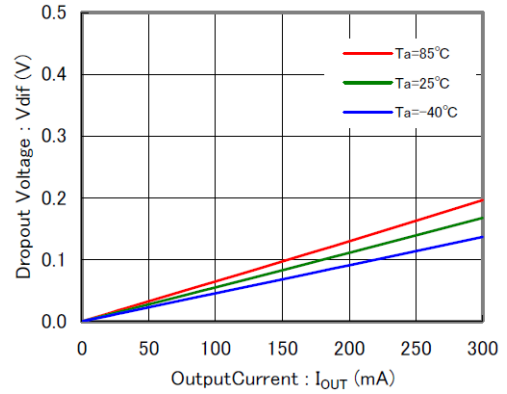

### (4) Supply Current vs. Input Voltage

**IXD1421**

$V_{OUT} = 1.2\text{ V}$

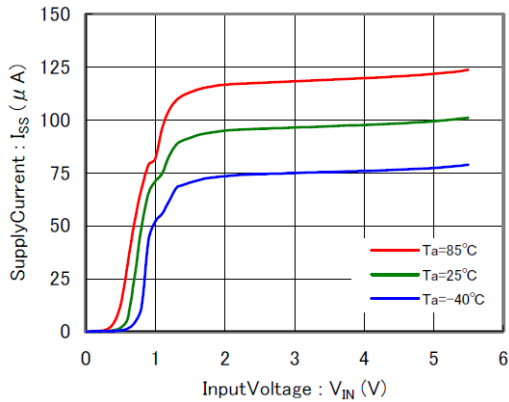

**IXD1421**

$V_{OUT} = 1.8\text{ V}$

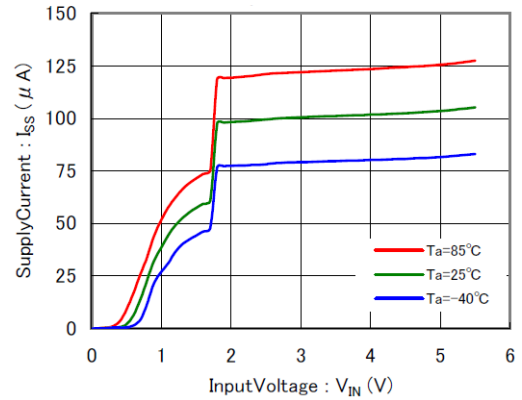

**IXD1421**

$V_{OUT} = 2.5\text{ V}$

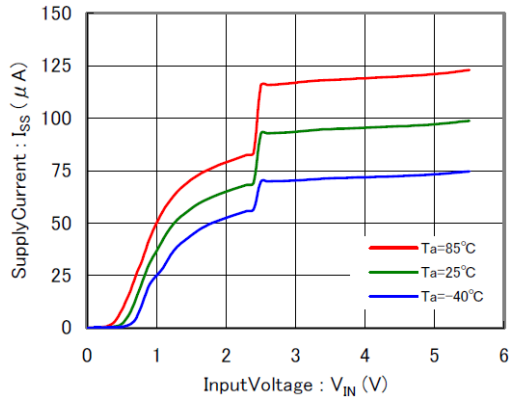

**IXD1421**

$V_{OUT} = 3.6\text{ V}$

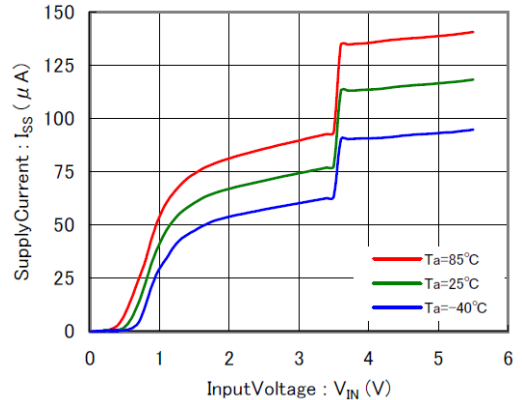

## TYPICAL PERFORMANCE CHARACTERISTICS (Continued)

### (5) Output Voltage vs. Ambient Temperature

**IXD1421**  
 $V_{OUT} = 1.2\text{ V}$

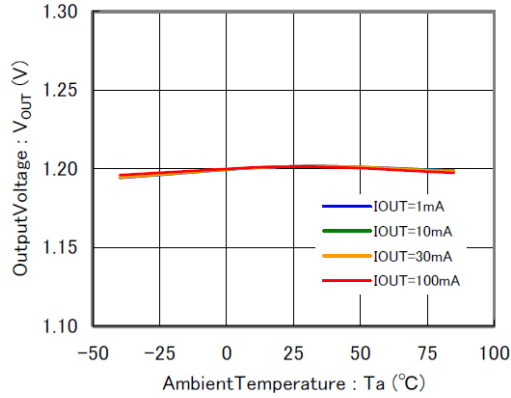

**IXD1421**  
 $V_{OUT} = 1.8\text{ V}$

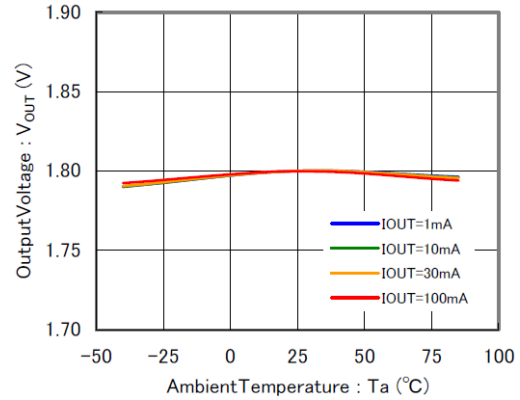

**IXD1421**  
 $V_{OUT} = 2.5\text{ V}$

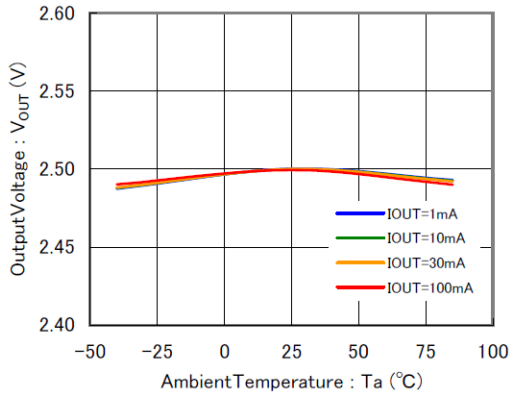

**IXD1421**  
 $V_{OUT} = 3.6\text{ V}$

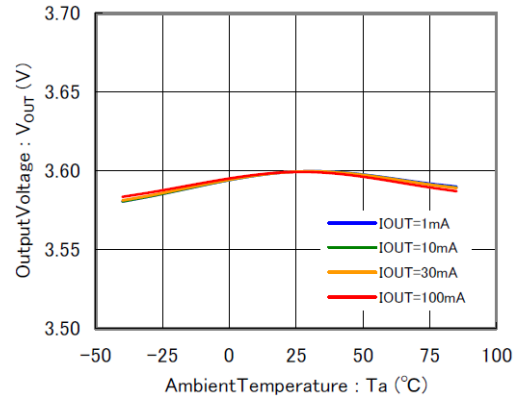

### (6) Supply Current vs./ Ambient Temperature

**IXD1421**  
 $V_{IN} = V_{OUT} + 1.0\text{ V}$

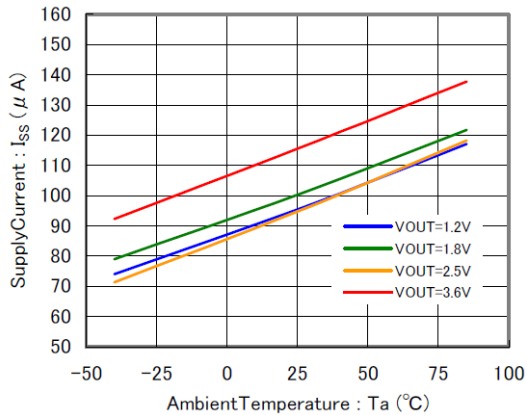

### (7) EN Threshold Voltage vs. Ambient Temperature

**IXD1421**

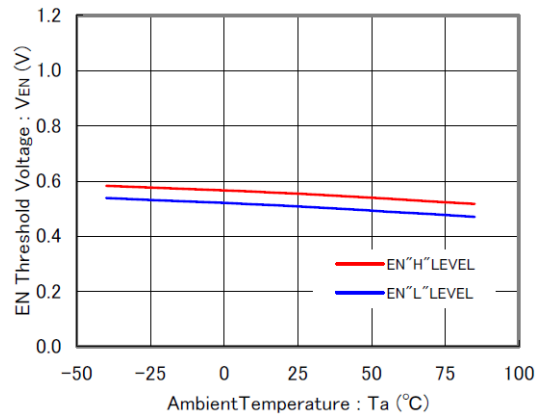

## TYPICAL PERFORMANCE CHARACTERISTICS (Continued)

### (8) $V_{IN}$ Rising Response Time

#### IXD1421

$V_{OUT} = 1.2\text{ V}$ ,  $V_{IN} = 0\text{ V} \rightarrow 2.2\text{ V}$ ,  $t_R = 5\ \mu\text{s}$

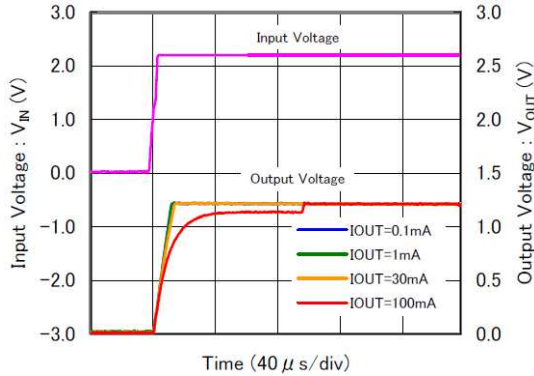

#### IXD1421

$V_{OUT} = 1.8\text{ V}$ ,  $V_{IN} = 0\text{ V} \rightarrow 2.8\text{ V}$ ,  $t_R = 5\ \mu\text{s}$

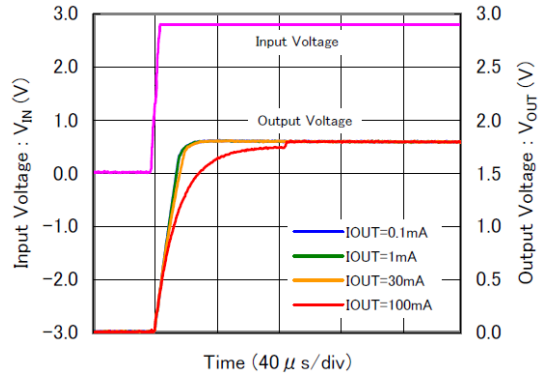

#### IXD1421

$V_{OUT} = 2.5\text{ V}$ ,  $V_{IN} = 0\text{ V} \rightarrow 3.5\text{ V}$ ,  $t_R = 5\ \mu\text{s}$

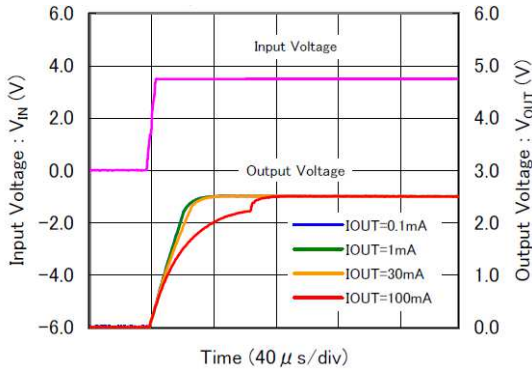

#### IXD1421

$V_{OUT} = 3.6\text{ V}$ ,  $V_{IN} = 0\text{ V} \rightarrow 4.6\text{ V}$ ,  $t_R = 5\ \mu\text{s}$

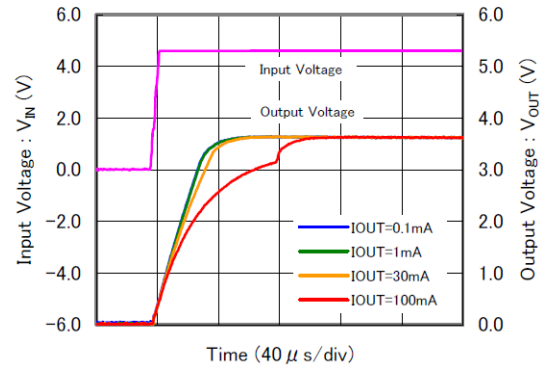

### (9) $V_{IN}$ Transient Response

#### IXD1421

$V_{OUT} = 1.2\text{ V}$ ,  $V_{IN} = 2.2\text{ V} \leftrightarrow 3.2\text{ V}$ ,  $t_R = t_F = 5\ \mu\text{s}$

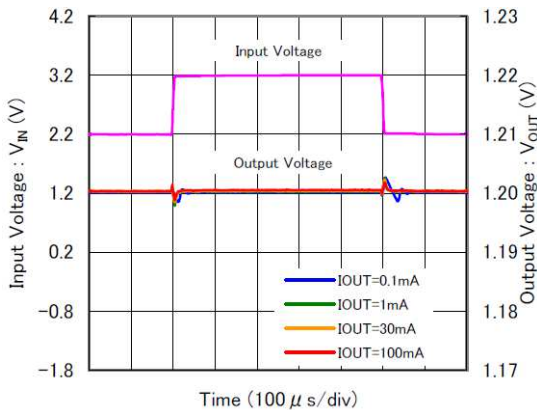

#### IXD1421

$V_{OUT} = 1.8\text{ V}$ ,  $V_{IN} = 2.8\text{ V} \leftrightarrow 3.8\text{ V}$ ,  $t_R = t_F = 5\ \mu\text{s}$

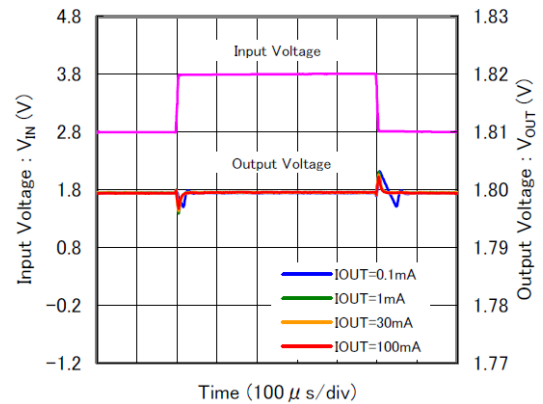

## TYPICAL PERFORMANCE CHARACTERISTICS (Continued)

### (9) $V_{IN}$ Transient Response (Continued)

#### IXD1421

$V_{OUT} = 2.5\text{ V}$ ,  $V_{IN} = 3.5\text{ V} \leftrightarrow 4.5\text{ V}$ ,  $t_R = t_F = 5\ \mu\text{s}$

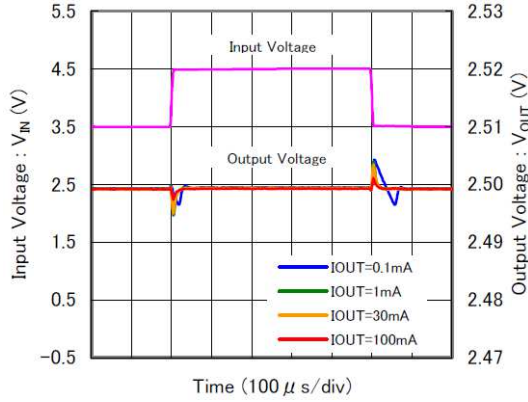

#### IXD1421

$V_{OUT} = 3.6\text{ V}$ ,  $V_{IN} = 4.6\text{ V} \leftrightarrow 5.5\text{ V}$ ,  $t_R = t_F = 5\ \mu\text{s}$

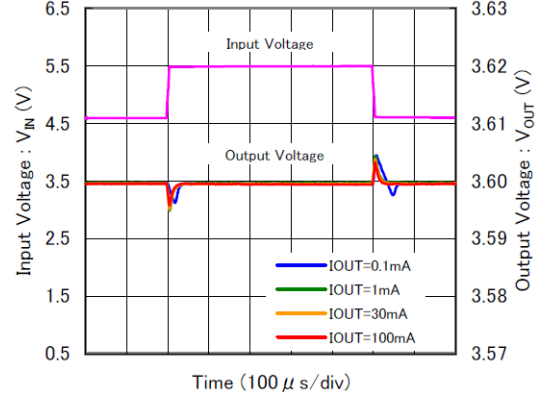

### (10) Load transient Response

#### IXD1421

$V_{OUT} = 1.2\text{ V}$ ,  $V_{IN} = 2.2\text{ V}$ ,  $I_{OUT} = .1 \leftrightarrow 100\text{ mA}$ ,  $t_R = t_F = 5\ \mu\text{s}$

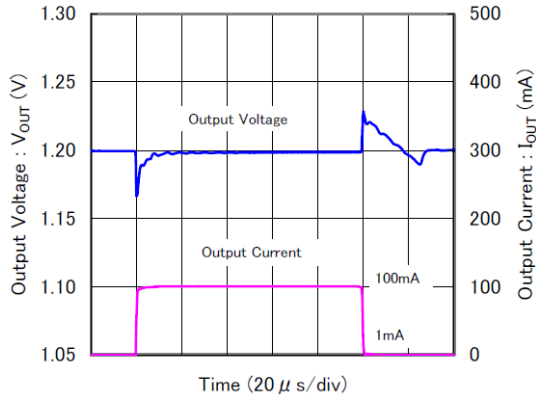

#### IXD1421

$V_{OUT} = 1.2\text{ V}$ ,  $V_{IN} = 2.2\text{ V}$ ,  $I_{OUT} = .01 \leftrightarrow 300\text{ mA}$ ,  $t_R = t_F = 5\ \mu\text{s}$

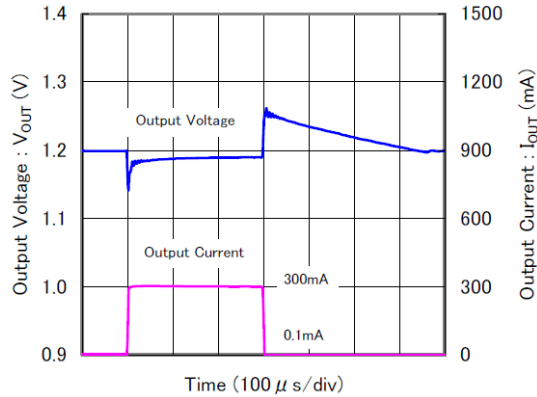

#### IXD1421

$V_{OUT} = 1.8\text{ V}$ ,  $V_{IN} = 2.8\text{ V}$ ,  $I_{OUT} = .1 \leftrightarrow 100\text{ mA}$ ,  $t_R = t_F = 5\ \mu\text{s}$

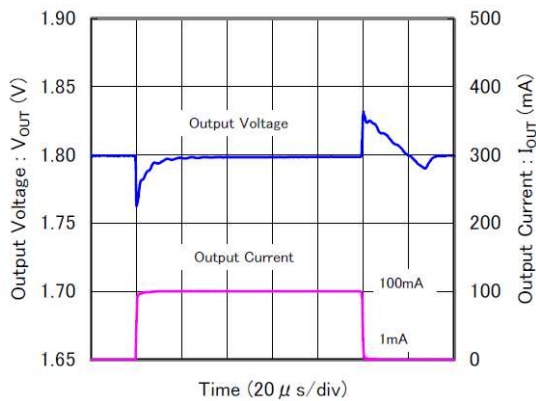

#### IXD1421

$V_{OUT} = 1.8\text{ V}$ ,  $V_{IN} = 2.8\text{ V}$ ,  $I_{OUT} = .01 \leftrightarrow 300\text{ mA}$ ,  $t_R = t_F = 5\ \mu\text{s}$

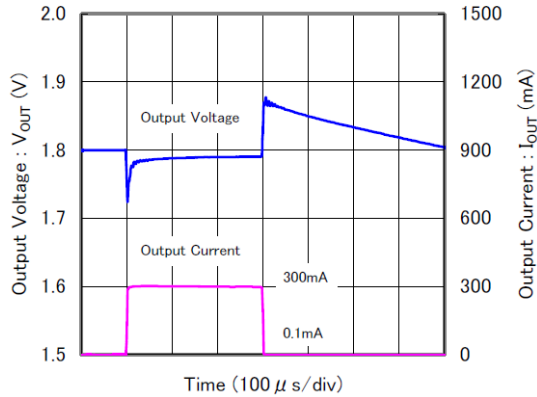

## TYPICAL PERFORMANCE CHARACTERISTICS (Continued)

### (10) Load Transient Response (Continued)

#### IXD1421

$V_{OUT} = 2.5\text{ V}$ ,  $V_{IN} = 3.5\text{ V}$ ,  $I_{OUT} = .1 \leftrightarrow 100\text{ mA}$ ,  $t_R = t_F = 5\ \mu\text{s}$

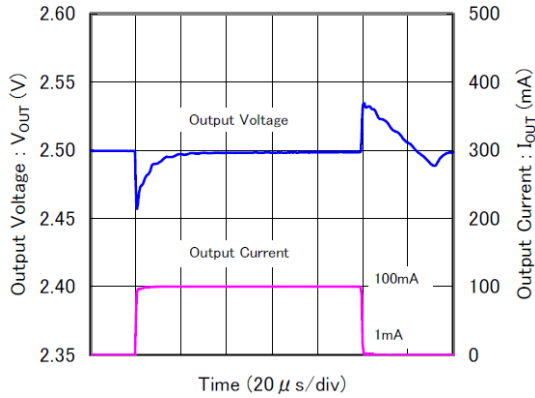

#### IXD1421

$V_{OUT} = 2.5\text{ V}$ ,  $V_{IN} = 3.5\text{ V}$ ,  $I_{OUT} = .01 \leftrightarrow 300\text{ mA}$ ,  $t_R = t_F = 5\ \mu\text{s}$

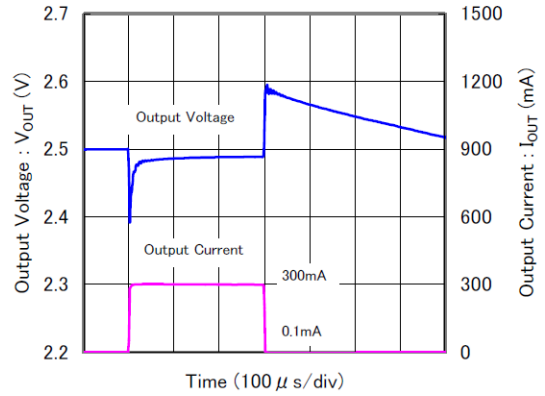

#### IXD1421

$V_{OUT} = 3.6\text{ V}$ ,  $V_{IN} = 4.6\text{ V}$ ,  $I_{OUT} = .1 \leftrightarrow 100\text{ mA}$ ,  $t_R = t_F = 5\ \mu\text{s}$

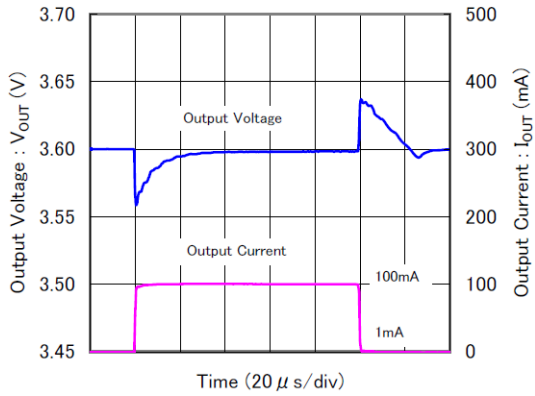

#### IXD1421

$V_{OUT} = 3.6\text{ V}$ ,  $V_{IN} = 4.6\text{ V}$ ,  $I_{OUT} = .01 \leftrightarrow 300\text{ mA}$ ,  $t_R = t_F = 5\ \mu\text{s}$

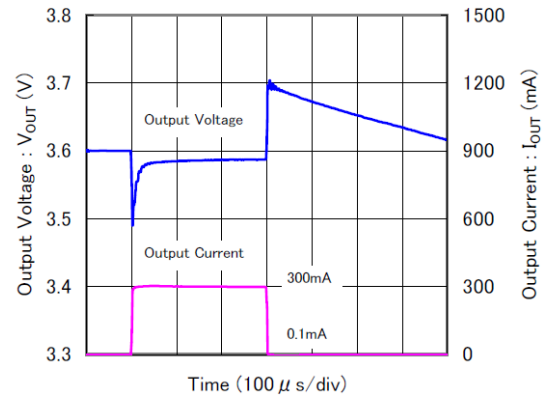

### (11) $V_{EN}$ Rising Response Time

#### IXD1421

$V_{OUT} = 1.2\text{ V}$ ,  $V_{IN} = 2.2\text{ V}$ ,  $V_{EN} = 0\text{ V} \rightarrow 2.2\text{ V}$ ,  $t_R = 5\ \mu\text{s}$

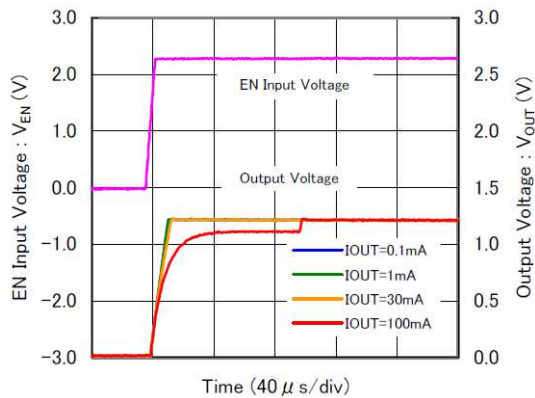

#### IXD1421

$V_{OUT} = 1.8\text{ V}$ ,  $V_{IN} = 2.8\text{ V}$ ,  $V_{EN} = 0\text{ V} \rightarrow 2.8\text{ V}$ ,  $t_R = 5\ \mu\text{s}$

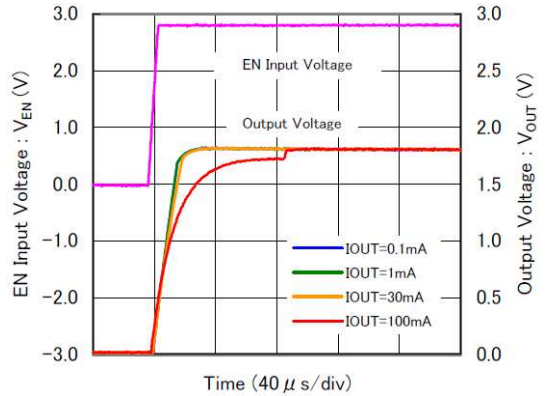

## TYPICAL PERFORMANCE CHARACTERISTICS (Continued)

### (11) $V_{EN}$ Rising Response Time (Continued)

#### IXD1421

$V_{OUT} = 2.5\text{ V}$ ,  $V_{IN} = 3.5\text{ V}$ ,  $V_{EN} = 0\text{ V} \rightarrow 3.5\text{ V}$ ,  $t_R = 5\text{ }\mu\text{s}$

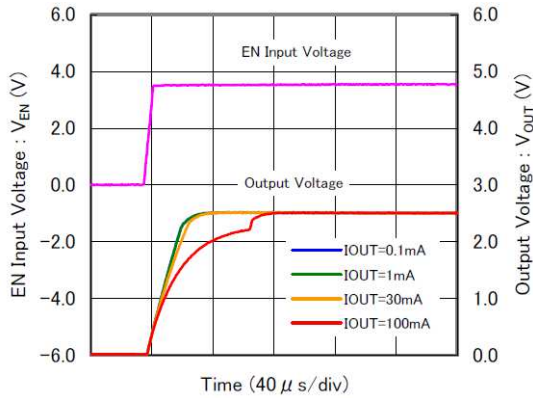

#### IXD1421

$V_{OUT} = 3.6\text{ V}$ ,  $V_{IN} = 4.6\text{ V}$ ,  $V_{EN} = 0\text{ V} \rightarrow 4.6\text{ V}$ ,  $t_R = 5\text{ }\mu\text{s}$

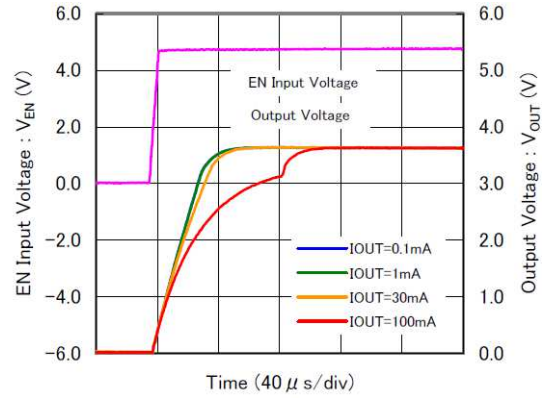

### (12) Ripple Rejection Ratio

#### IXD1421

$V_{OUT} = 1.2\text{ V}$ ,  $V_{IN} = 3.0\text{ V}_{DC} + 0.5\text{ V}_p\text{-p}_{AC}$

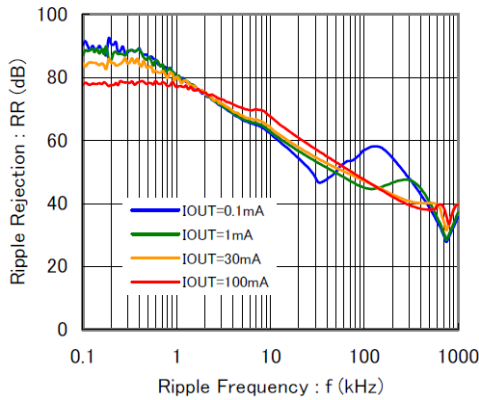

#### IXD1421

$V_{OUT} = 1.8\text{ V}$ ,  $V_{IN} = 3.0\text{ V}_{DC} + 0.5\text{ V}_p\text{-p}_{AC}$

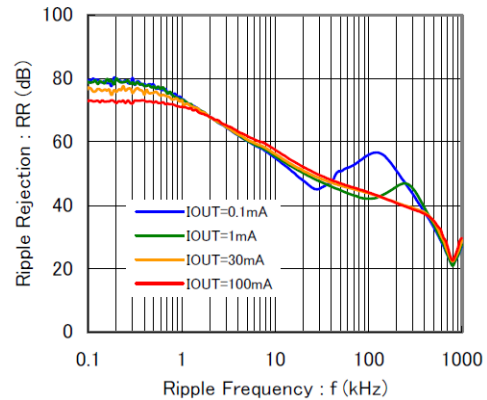

#### IXD1421

$V_{OUT} = 2.5\text{ V}$ ,  $V_{IN} = 3.5\text{ V}_{DC} + 0.5\text{ V}_p\text{-p}_{AC}$

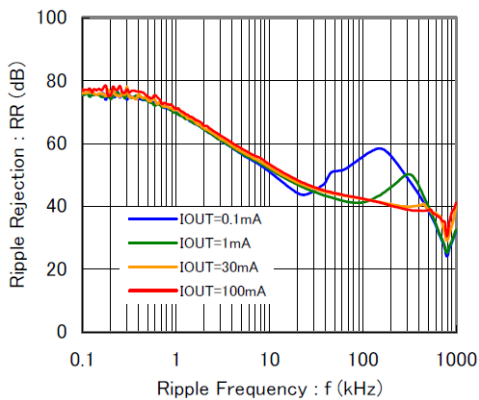

#### IXD1421

$V_{OUT} = 3.6\text{ V}$ ,  $V_{IN} = 4.6\text{ V}_{DC} + 0.5\text{ V}_p\text{-p}_{AC}$

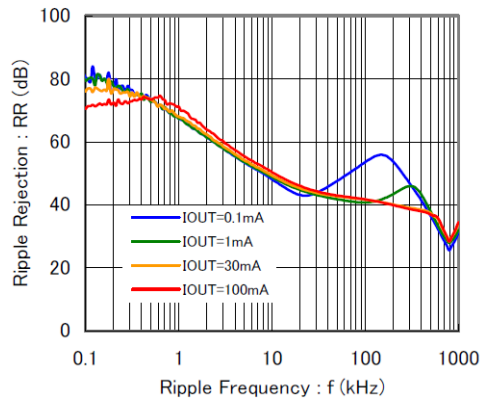

## TYPICAL PERFORMANCE CHARACTERISTICS (Continued)

### (13) Inrush Current Response

#### IXD1421

$V_{OUT} = 1.2\text{ V}$ ,  $V_{IN} = 2.2\text{ V}$ ,  $t_R = 5\ \mu\text{s}$ ,  $V_{EN} = 0\text{ V} \rightarrow V_{IN}$

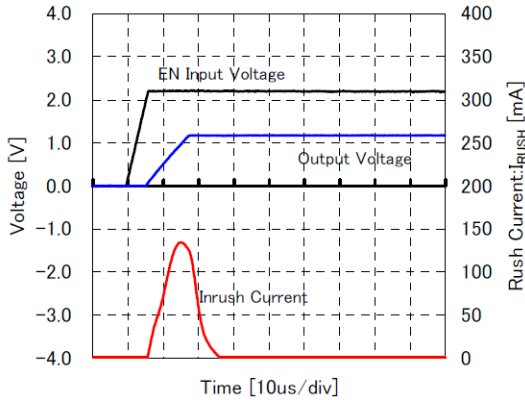

#### IXD1421

$V_{OUT} = 1.8\text{ V}$ ,  $V_{IN} = 2.8\text{ V}$ ,  $t_R = 5\ \mu\text{s}$ ,  $V_{EN} = 0\text{ V} \rightarrow V_{IN}$

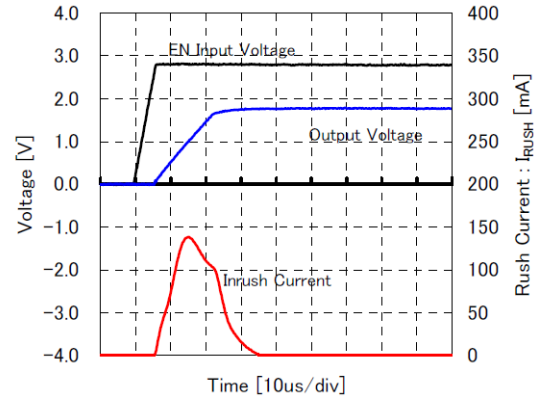

#### IXD1421

$V_{OUT} = 2.5\text{ V}$ ,  $V_{IN} = 3.5\text{ V}$ ,  $t_R = 5\ \mu\text{s}$ ,  $V_{EN} = 0\text{ V} \rightarrow V_{IN}$

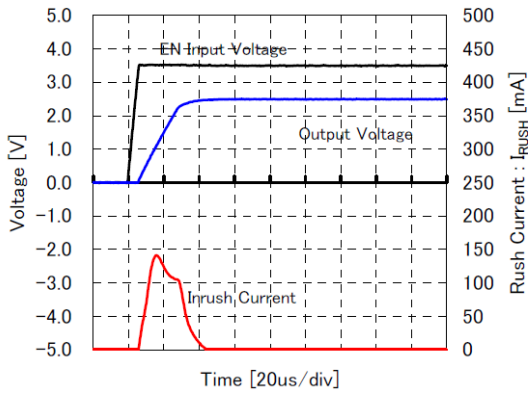

#### IXD1421

$V_{OUT} = 3.6\text{ V}$ ,  $V_{IN} = 4.6\text{ V}$ ,  $t_R = 5\ \mu\text{s}$ ,  $V_{EN} = 0\text{ V} \rightarrow V_{IN}$

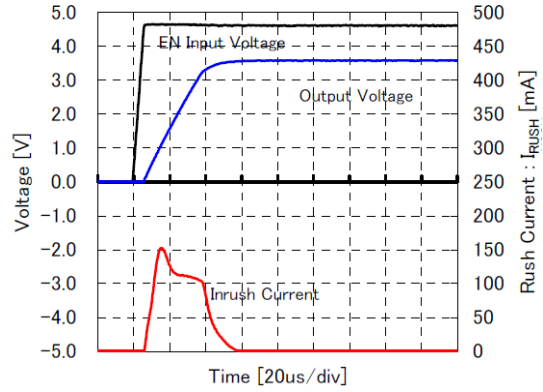

### (14) Cross Talk

#### IXD1421

$V_{OUT1} = 1.8\text{ V}$ ,  $V_{OUT2} = 1.8\text{ V}$ ,  $V_{IN} = 2.8\text{ V}$ ,  $I_{OUT1} = 30\text{ mA}$ ,  $I_{OUT2} = .1 \leftrightarrow 150\text{ mA}$ ,  $t_R = t_F = 5\ \mu\text{s}$

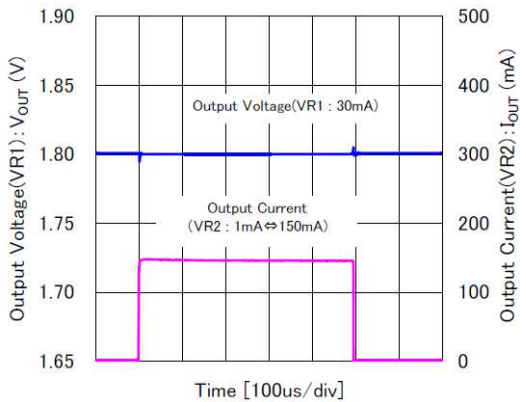

#### IXD1421

$V_{OUT1} = 3.6\text{ V}$ ,  $V_{OUT2} = 3.6\text{ V}$ ,  $V_{IN} = 4.6\text{ V}$ ,  $I_{OUT1} = 30\text{ mA}$ ,  $I_{OUT2} = .1 \leftrightarrow 150\text{ mA}$ ,  $t_R = t_F = 5\ \mu\text{s}$

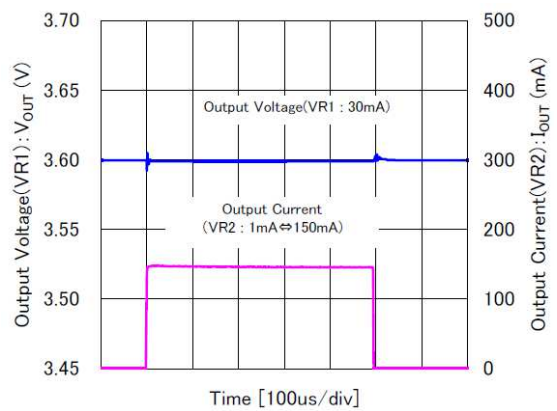

## TYPICAL PERFORMANCE CHARACTERISTICS (Continued)

### (15) Output Noise Density

#### IXD1421

$V_{OUT} = 1.2\text{ V}$ ,  $V_{IN} = 2.2\text{ V}$ ,

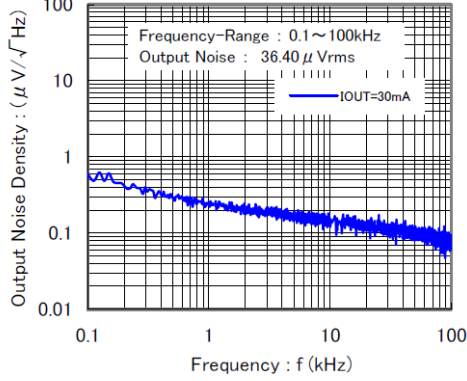

#### IXD1421

$V_{OUT} = 1.8\text{ V}$ ,  $V_{IN} = 2.8\text{ V}$

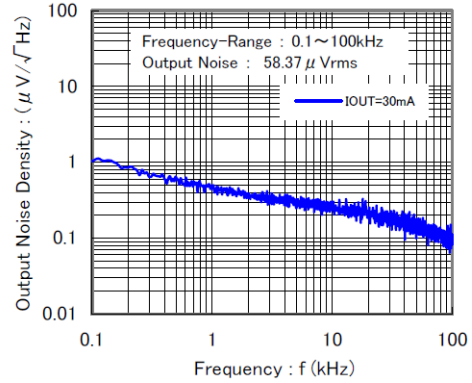

#### IXD1421

$V_{OUT} = 3.3\text{ V}$ ,  $V_{IN} = 5.0\text{ V}$ ,

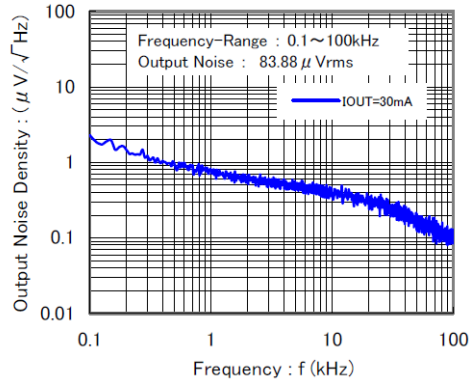



## ORDERING INFORMATION

IXD1421 ①②③④⑤⑥-⑦

DESIGNATOR	DESCRIPTION	SYMBOL	FUNCTIONS
①	Type of Regulator	A	EN1 and EN2 Active High, Thermal Shutdown, Inrush Current Protection, C <sub>L1</sub> and C <sub>L2</sub> Auto Discharge
②	Enable Pin	B	EN1 and EN2 with Pull-down Resistors
③④	Output Voltage		Refer to the Table <i>Designators ③④</i>
⑤⑥-⑦ <sup>(*)</sup>	Packages (Order Limit) <sup>1)</sup>	ER-G	USP-6C (3000/reel)

### NOTE:

The “-G” suffix denotes Halogen and Antimony free as well as being fully RoHS compliant.

### Designators ③④

③④	VR1	VR2	③④	VR1	VR2
01	1.20	1.20	34	2.80	3.00
02	1.20	1.50	35	2.80	3.30
03	1.20	2.50	36	1.20	3.60
04	1.20	2.85	37	3.60	1.20
05	1.20	3.00	38	1.20	2.80
06	1.20	3.30	39	3.30	2.00
07	1.50	1.50	40	3.00	3.30
08	1.50	1.80	41	3.30	3.30
09	1.50	2.50	42	1.30	1.50
10	1.50	2.85	43	2.60	2.80
11	1.50	3.00	44	3.10	3.30
12	1.50	3.30	45	1.50	2.60
13	1.80	1.80	46	2.60	3.30
14	1.80	2.50	47	3.40	3.40
15	2.85	2.85	48	2.85	2.60
16	1.80	2.85	49	3.30	1.80
17	1.80	3.00	50	1.80	1.20
18	3.00	1.80	51	3.10	3.10
19	1.80	3.30	52	1.50	3.10
20	2.50	2.50	53	3.30	2.80
21	2.50	2.80	54	3.00	2.80
22	2.50	2.85	55	3.30	3.00
23	3.30	1.50	56	3.60	3.60
24	2.50	3.00	57	3.30	3.10
25	2.50	3.30	58	3.10	3.00
26	2.85	3.00	59	3.10	2.90
27	2.85	3.30	60	3.10	2.50
28	3.00	3.00	61	3.00	2.90
29	1.20	1.80	62	3.00	2.50
30	1.30	2.80	63	1.80	1.90
31	1.50	2.80	64	1.80	1.85
32	1.80	2.80	65	1.70	1.70
33	2.80	2.80			

## PACKAGE DRAWING AND DIMENSIONS

USP-6C, Units: mm

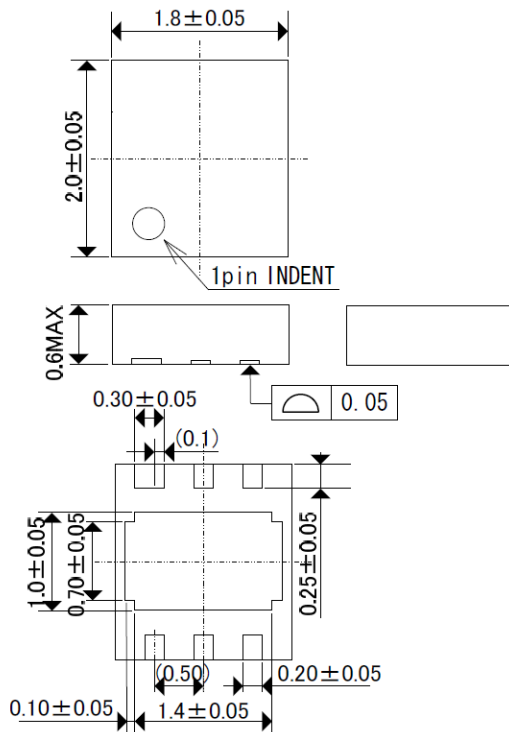

USP-6C Reference Pattern Layout

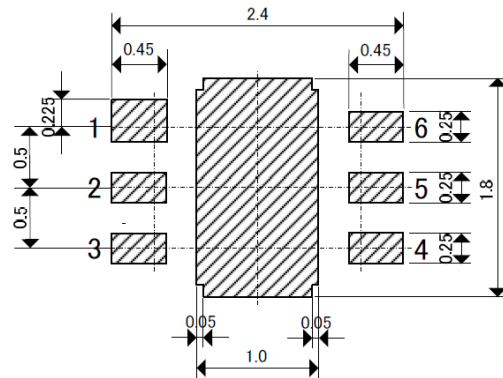

USP-6C Reference Metal Mask Design

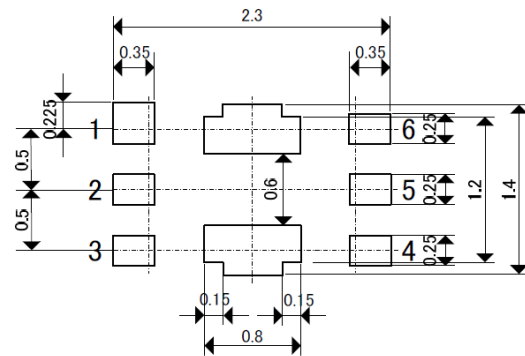

## PACKAGE POWER DISSIPATION

### USP-6C Power Dissipation

The power dissipation varies with the mount board conditions. Please use this data as a reference only.

#### 1. Measurement Conditions:

Condition: Mount on a board  
 Ambient: Natural convection  
 Soldering: Lead (Pb) free  
 Board: Dimensions 40x40 mm (1600 mm<sup>2</sup> in one side)  
 Copper (Cu) traces occupy 50% of the board area  
 on top and bottom layers  
 Package heat sink teed to copper traces  
 Material: Glass Epoxy (FR-4)  
 Thickness: 1.6 mm  
 Through-hole: 4 x 0.8 Diameter

#### 2. Power Dissipation vs. Ambient Temperature

Board Mount ( $T_{jmax} = 125\text{ }^{\circ}\text{C}$ )

Ambient Temperature, $^{\circ}\text{C}$	Power Dissipation Pd, mW	Thermal Resistance, $^{\circ}\text{C}/\text{W}$
25	1000	100.00
85	400	

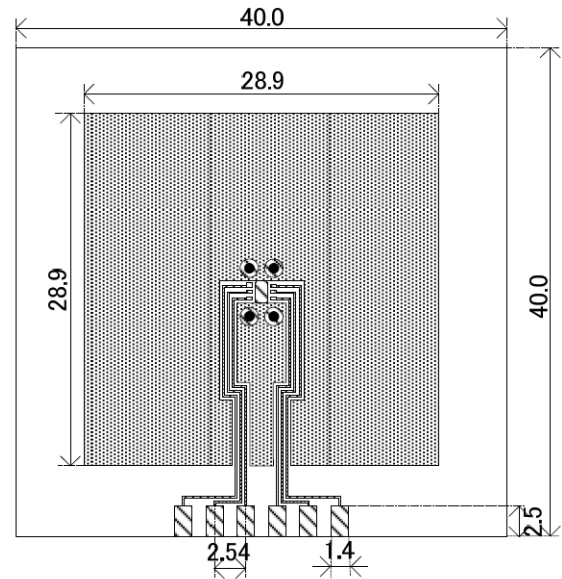

Evaluation Board (Unit: mm)

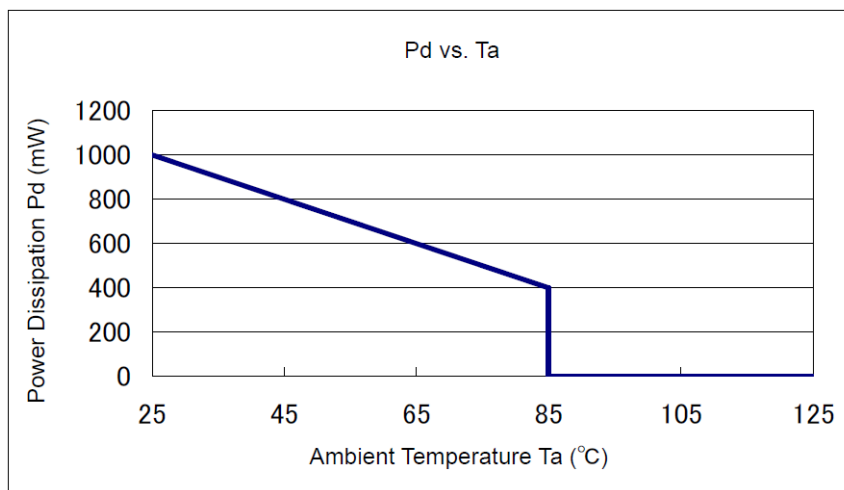

## MARKING

USP-6C

① - represents product series

MARK	PRODUCT SERIES
R	IXD1421xxxxx-G

②③ - represent output voltage (see table below)

MARK		PRODUCT SERIES
②	③	
0	1	IXD1421xx01xx-G

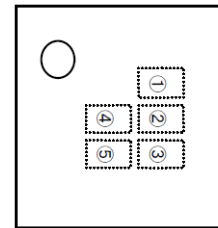

②③	VR1	VR2	②③	VR1	VR2
01	1.20	1.20	34	2.80	3.00
02	1.20	1.50	35	2.80	3.30
03	1.20	2.50	36	1.20	3.60
04	1.20	2.85	37	3.60	1.20
05	1.20	3.00	38	1.20	2.80
06	1.20	3.30	39	3.30	2.00
07	1.50	1.50	40	3.00	3.30
08	1.50	1.80	41	3.30	3.30
09	1.50	2.50	42	1.30	1.50
10	1.50	2.85	43	2.60	2.80
11	1.50	3.00	44	3.10	3.30
12	1.50	3.30	45	1.50	2.60
13	1.80	1.80	46	2.60	3.30
14	1.80	2.50	47	3.40	3.40
15	2.85	2.85	48	2.85	2.60
16	1.80	2.85	49	3.30	1.80
17	1.80	3.00	50	1.80	1.20
18	3.00	1.80	51	3.10	3.10
19	1.80	3.30	52	1.50	3.10
20	2.50	2.50	53	3.30	2.80
21	2.50	2.80	54	3.00	2.80
22	2.50	2.85	55	3.30	3.00
23	3.30	1.50	56	3.60	3.60
24	2.50	3.00	57	3.30	3.10
25	2.50	3.30	58	3.10	3.00
26	2.85	3.00	59	3.10	2.90
27	2.85	3.30	60	3.10	2.50
28	3.00	3.00	61	3.00	2.90
29	1.20	1.80	62	3.00	2.50
30	1.30	2.80	63	1.80	1.90
31	1.50	2.80	64	1.80	1.85
32	1.80	2.80	65	1.70	1.70
33	2.80	2.80			

④⑤ - represents production lot number

01~09, 0A~0Z, 11~9Z, A1~A9, AA~AZ, B1~ZZ in order, (G, I, J, O, Q, W excluded)