

## 0.6 $\mu$ A Current Consumption Voltage Regulator

### FEATURES

- Low Power Consumption at 0.6  $\mu$ A typical
- Operating Voltage Range 1.4 V – 6.0 V
- Output Voltage Range from 1.1 V to 5.0 V with 0.1 V increments
- Output Voltage Accuracy  $\pm 0.02$  V at  $V_{OUT} < 2.0$  V, or  $\pm 1\%$
- Temperature Stability  $\pm 50$  ppm/ $^{\circ}$ C
- Output Current up to 150 mA
- Dropout Voltage 500 mV @ 150 mA,  $V_{OUT} = 3.0$  V
- Standby Current less than 0.01  $\mu$ A typical
- Load Capacitor Auto Discharge
- Current Limit and Short Circuit Protection
- Low ESR Ceramic Capacitor compatible
- Stable operations without load capacitor
- ON/OFF switch
- Operating Ambient Temperature - 40 + 85 $^{\circ}$ C
- Packages : SOT-25, SSOT-24, and USPN-4B02
- EU RoHS Compliant, Pb Free

### APPLICATIONS

- Mobile phones
- Cameras, VCRs
- Various portable equipment

### DESCRIPTION

The IXD1504 is a highly accurate CMOS voltage regulator with very low supply current of 0.6  $\mu$ A. It is able to provide very accurate output voltage even at load current as low as 1  $\mu$ A, which is ideally suited for battery-powered applications. The usage of super small package USPN-4B02 (0.75 x 0.95 mm) and the advantage of capacitor-less stable operations contribute to saving board space.

The IC consists of a reference voltage source, an error amplifier, a driver transistor, over-current protection circuit, and a phase compensation circuit.

Excellent internal phase compensation allows the IXD1504 to operate either with a low ESR ceramic output capacitor  $C_L$ , or even without it.

Output voltage is fixed internally by laser trimming technology and selectable in 0.1 V increments within the range from 1.1 V to 5.0 V.

The CE input allows set IXD1504 into standby mode reducing current consumption to less than 0.01  $\mu$ A.

If a  $C_L$  output capacitor is used, the internal switch discharges this capacitor in standby mode to return quickly  $V_{OUT}$  voltage to the  $V_{SS}$  level,

This regulator is available in SOT-25, SSOT-24, and USPN-4B02 packages.

### TYPICAL APPLICATION CIRCUIT



### TYPICAL PERFORMANCE CHARACTERISTIC

#### Supply Current vs. Input Voltage

$C_{IN} = C_L = \text{open}$ ,  $V_{CE} = V_{IN}$ ,  $I_{OUT} = 0$  mA,



## ABSOLUTE MAXIMUM RATINGS

PARAMETER		SYMBOL	RATINGS	UNITS
Input Voltage		$V_{IN}$	- 0.3 ~ +6.5	V
Output Current		$I_{OUT}$	470 <sup>1)</sup>	mA
Output Voltage		$V_{OUT}$	- 0.3 ~ $V_{IN} + 0.3$ or +6.5 V <sup>2)</sup>	V
CE Input Voltage		$V_{CE}$	- 0.3 ~ +6.5	V
Power Dissipation <sup>2)</sup>	SOT-25	$P_D$	250	mW
			600 (PCB mounted)	
	SSOT-24		150	
			500 (PCB mounted)	
			100	
USPN-4B02	550 (PCB mounted)			
Operating Temperature Range		$T_{OPR}$	- 40 ~ + 85	°C
Storage Temperature Range		$T_{STG}$	- 55 ~ +125	°C

All voltages are in respect to  $V_{SS}$

- $I_{OUT} \leq P_d / (V_{IN} - V_{OUT})$
- The lowest value between  $V_{IN} + 0.3$  and 6.5 V
- This is a reference data taken by using the test board. Please refer to page 20 to 22 for details

## ELECTRICAL OPERATING CHARACTERISTICS

$T_a = 25^\circ\text{C}$

PARAMETER	SYMBOL	CONDITIONS	MIN.	TYP.	MAX.	UNIT	CIRCUIT
Input Voltage	$V_{IN}$		1.4		6.0	V	①
Output Voltage <sup>1)</sup>	$V_{OUT(E)}$	$V_{OUT(T)} \geq 2\text{ V}^3$	$V_{OUT(T)} \times 0.99$	$V_{OUT(T)}^*$	$V_{OUT(T)} \times 1.01$	V	①
		$V_{OUT(T)} < 2\text{ V}^3$	$V_{OUT(T)} - 0.02$	$V_{OUT(T)}^*$	$V_{OUT(T)} + 0.02$		
Maximum Output Current	$I_{OUT\_MAX}$		150			mA	①
Load Regulation	$\Delta V_{OUT}$	$1\ \mu\text{A} \leq I_{OUT} \leq 1\ \text{mA}$		3	16	mV	①
		$1\ \text{mA} \leq I_{OUT} \leq 150\ \text{mA}$		17	50		
Dropout Voltage <sup>2)</sup>	$V_{DIF1}$	$I_{OUT} = 50\ \text{mA}$		$E-1^3$		V	①
	$V_{DIF2}$	$I_{OUT} = 150\ \text{mA}$		$E-2^3$			
Supply Current	$I_{SS}$	$I_{OUT} = 0\ \text{mA}$	$V_{OUT(T)} < 1.9\ \text{V}$	0.60	1.27	$\mu\text{A}$	②
			$1.9\ \text{V} \leq V_{OUT(T)} < 4.0\ \text{V}$	0.65	1.50		
			$V_{OUT(T)} \geq 4.0\ \text{V}$	0.80	1.80		
Standby Current	$I_{STB}$	$V_{CE} = 0\ \text{V}$		0.01	0.10	$\mu\text{A}$	②
Line Regulation	$\frac{\Delta V_{OUT}}{V_{OUT} * \Delta V_{IN}}$	$I_{OUT} = 1\ \mu\text{A}, V_{OUT(T)} + 0.5\ \text{V} \leq V_{IN} \leq 6.0\ \text{V}$		0.01	0.13	%V	①
		$I_{OUT} = 1\ \text{mA}, V_{OUT(T)} + 0.5\ \text{V} \leq V_{IN} \leq 6.0\ \text{V},$ if $V_{OUT(T)} \geq 1.2\ \text{V}$ , or $1.7\ \text{V} \leq V_{IN} \leq 6.0\ \text{V}$		0.01	0.19		
Output Voltage Temperature Characteristics	$\frac{\Delta V_{OUT}}{V_{OUT} * \Delta T_{OPR}}$	$I_{OUT} = 10\ \text{mA}$ $-40^\circ\text{C} \leq T_{OPR} \leq 85^\circ\text{C}$		$\pm 50$		ppm/°C	①
Current Limit	$I_{LIM}$	$V_{OUT} = V_{OUT(E)} \times 0.95$	150	270		mA	①
Short Current	$I_{SHORT}$	$V_{OUT} = V_{SS}$		80		mA	①
$C_L$ Discharge Resistance	$R_{DCH}$	$V_{CE} = 0\ \text{V}, V_{OUT} = V_{OUT(T)}$	280	450	640	$\Omega$	①
CE "H" Level Voltage	$V_{CEH}$		0.91		$V_{IN}$	V	③
CE "L" Level Voltage	$V_{CEL}$				0.38	V	③
CE "H" Level Current	$I_{CEH}$	$V_{CE} = V_{IN} = 6.0\ \text{V}$	-0.1		0.1	$\mu\text{A}$	③
CE "L" Level Current	$I_{CEL}$	$V_{IN} = 6.0\ \text{V}, V_{CE} = V_{SS}$	-0.1		0.1	$\mu\text{A}$	③

### NOTE:

Unless otherwise stated,  $V_{IN} = V_{CE} = V_{OUT(T)} + 1.0\ \text{V}$ , if  $V_{OUT(T)} \geq 2.5\ \text{V}$ , or  $V_{IN} = V_{CE} = 3.5\ \text{V}$ ,  $I_{OUT} = 1\ \text{mA}$ ,  $C_{IN} = C_L = \text{open}$

- $V_{OUT(T)}$  is Nominal output voltage and  $V_{OUT(E)}$  is Effective output voltage, (I.e. the output voltage when " $V_{OUT(T)} + 1.0\text{V}$ " is provided at the  $V_{IN}$  pin, while maintaining a certain  $I_{OUT}$  value).
- $V_{DIF} = \{V_{IN} - V_{OUT}\}$ , where  $V_{IN1}$  is the input voltage when  $V_{OUT} = 0.98 V_{OUT(T)}$  appears, while input voltage gradually decreases
- Refer to the Table "Voltage Chart. Dropout Voltage"

**ELECTRICAL OPERATING CHARACTERISTICS (CONTINUED)**

Voltage Chart

NOMINAL OUTPUT VOLTAGE $V_{OUT(T)}$ , V	OUTPUT VOLTAGE, V		E-1		E-2	
			DROPOUT VOLTAGE, V			
	$V_{OUT(E)}$		$V_{dif1}$		$V_{dif2}$	
(V)	MIN.	MAX.	TYP.	MAX.	TYP.	MAX.
1.1	1.0800	1.1200	0.96	1.35	1.51	2.05
1.2	1.1800	1.2200	0.87	1.23	1.41	1.93
1.3	1.2800	1.3200	0.77	1.12	1.33	1.83
1.4	1.3800	1.4200	0.69	1.01	1.24	1.72
1.5	1.4800	1.5200	0.62	0.91	1.17	1.63
1.6	1.5800	1.6200	0.56	0.84	1.10	1.54
1.7	1.6800	1.7200	0.51	0.77	1.04	1.47
1.8	1.7800	1.8200	0.47	0.72	0.99	1.40
1.9	1.8800	1.9200	0.42	0.64	0.92	1.29
2.0	1.9800	2.0200	0.37	0.58	0.86	1.20
2.1	2.0790	2.1210				
2.2	2.1780	2.2220	0.31	0.47	0.75	1.05
2.3	2.2770	2.3230				
2.4	2.3760	2.4240	0.26	0.40	0.67	0.92
2.5	2.4750	2.5250				
2.6	2.5740	2.6260	0.23	0.34	0.60	0.82
2.7	2.6730	2.7270				
2.8	2.7720	2.8280	0.20	0.30	0.54	0.74
2.9	2.8710	2.9290				
3.0	2.9700	3.0300	0.17	0.26	0.50	0.67
3.1	3.0690	3.1310				
3.2	3.1680	3.2320	0.15	0.22	0.43	0.59
3.3	3.2670	3.3330				
3.4	3.3660	3.4340	0.13	0.19	0.38	0.51
3.5	3.4650	3.5350				
3.6	3.5640	3.6360	0.11	0.17	0.35	0.47
3.7	3.6630	3.7370				
3.8	3.7620	3.8380	0.10	0.16	0.32	0.43
3.9	3.8610	3.9390				
4.0	3.9600	4.0400				
4.1	4.0590	4.1410				
4.2	4.1580	4.2420				
4.3	4.2570	4.3430				
4.4	4.3560	4.4440				
4.5	4.4550	4.5450				
4.6	4.5540	4.6460				
4.7	4.6530	4.7470				
4.8	4.7520	4.8480				
4.9	4.8510	4.9490				
5.0	4.9500	5.0500				

## PIN CONFIGURATION

### PIN ASSIGNMENT

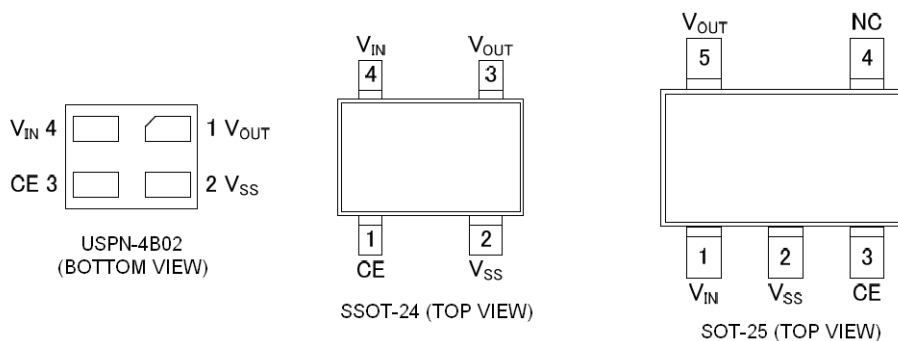

PIN NUMBER			PIN NAME	FUNCTIONS
SOT-25	SSOT-24	USPN-4B02		
5	3	1	$V_{OUT}$	Output Voltage
2	2	2	$V_{SS}$	Ground
3	1	3	CE	ON/OFF Control LOW – Standby mode, HIGH – Active <sup>1)</sup>
1	4	4	$V_{IN}$	Power Input
4			NC	No Connection

1) CE input does not have pull-down resistor and should not be in OPEN state. Connect it to the defined voltage source.

## BLOCK DIAGRAM

### IXD1504A



Diodes inside the circuits are ESD protection diodes and parasitic diodes.

## BASIC OPERATION

The Error Amplifier of the IXD1504 series monitors output voltage divided by internal resistors  $R_1$  &  $R_2$  and compares it with the internal Reference Voltage (see Block Diagram above). The output signal from error amplifier drives gate of the P-channel MOSFET, which is connected to the  $V_{OUT}$  pin and operates as a series voltage regulator.

The Current Limit/Short Protection circuits monitor level of the output current. The CE pin allows shutdown internal circuitry to minimize power consumption.

### Current Limiter, Short-Circuit Protection

The IXD1504 series include a combination of a fixed current limiter circuit & a foldback circuit, which aid the operations of the current limiter and circuit protection. When the load current reaches the current limit level, the fixed current limiter circuit activates and output voltage drops. Because of this drop, the foldback circuit activates too, and output voltage drops further decreasing output current. When the output pin is shorted, a current of about 80 mA flows.

### CE Pin

The CE pin allows shutdown internal circuitry to minimize power consumption. In shutdown mode, output at the  $V_{OUT}$  pin is pulled down to the  $V_{SS}$  level by  $R_{DCH}$  resistor and N-channel switch, as well as resistors R1 and R2 connected in series.

Note that the IXD1504 CE input is active HIGH and has no pull down resistor. IC will be in unstable state, if CE pin is open. CE pin current consumption may increase, if voltage applied to this pin is  $\sim 0.5$  of  $V_{IN}$ .

### $C_L$ High-speed Discharge Function

The N-channel transistor located between  $V_{OUT}$  and  $V_{SS}$  pins quickly discharge the output capacitor ( $C_L$ ), when the CE pin does low. The discharge time of the output capacitor ( $C_L$ ) is set by the  $C_L$  auto-discharge resistance  $R_{DCH} = 450 \Omega$  (TYP.) and the output capacitance ( $C_L$ ).

Time constant  $\tau = C_L \times R_{DCH}$  determines the output voltage after discharge as

$$V = V_{OUT(E)} \times e^{-t/\tau}$$

where:  $V_{OUT(E)}$  - Output voltage, and  $t$  - Discharge time

Discharge time can be calculated also by the next formula:

$$t = \tau \times \ln(V_{OUT(E)}/V)$$

### Low ESR Capacitors

An internal phase compensation circuit guarantees stable IXD1504 operation without output capacitor, or with low ESR capacitors. However, connect the output capacitor  $C_L$  as close to the  $V_{OUT}$  and the  $V_{SS}$  pins as possible, if it is used. In addition, an input capacitor  $C_{IN} \geq 0.1 \mu F$  between the  $V_{IN}$  and  $V_{SS}$  pins should be used to ensure a stable input power.

### TYPICAL APPLICATION CIRCUIT



### LAYOUT AND USE CONSIDERATIONS

1. Mount external component as close to the IC as possible and use thick, short connecting traces to reduce the circuit impedance.
2. The IC may malfunction if absolute maximum ratings are exceeded.
3. If power source of this regulator is a high impedance device, an input capacitor  $C_{IN} \geq 0.1 \mu F$  should be used to prevent oscillations.
4. In case of high output current, increasing the input capacitor value can stabilize operations.
5. Please ensure that output current  $I_{OUT}$  is less than  $P_D / (V_{IN} - V_{OUT})$ , where  $P_D$  is a rated power dissipation value of the package shown at ABSOLUTE MAXIMUM RATING table to not exceed it.

## TEST CIRCUITS

Circuit ①



Circuit ②

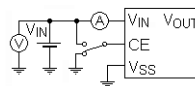

Circuit



Unless otherwise stated,  $T_a = 25^{\circ}\text{C}$ ,  $V_{CE} = V_{IN}$ ,  $I_{OUT} = 1\text{ mA}$ ,  $C_{IN} = C_L = \text{open}$ ,  $V_{IN} = 3.5\text{ V}$ , if  $V_{OUT(T)} < 2.5\text{ V}$ , or  $V_{IN} = V_{OUT(T)} + 1.0\text{ V}$

## TYPICAL PERFORMANCE CHARACTERISTICS

(1) Output Voltage vs. Output Current

IXD1504A121xR



IXD1504A121xR

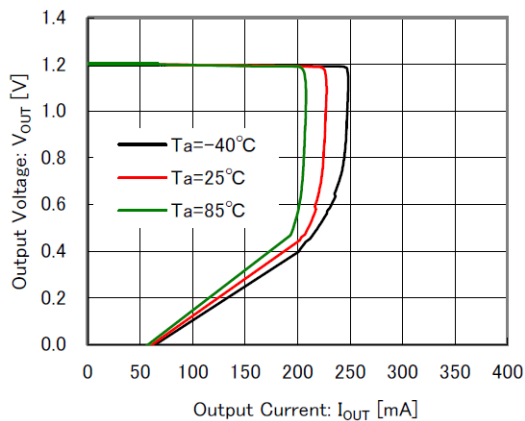

IXD1504A181xR



IXD1504A181xR



**TYPICAL PERFORMANCE CHARACTERISTICS (Continued)**

(1) Output Voltage vs Output Current (Continue)

Topr = 25 °C

**IXD1504A281xR**



**IXD1504A281xR**



**IXD1504A421xR**



**IXD1504A421xR**



(2) Output Voltage vs. Input Voltage

**IXD1504A121xR**



**IXD1504A121xR**



**TYPICAL PERFORMANCE CHARACTERISTICS (Continued)**

(2) Output Voltage vs. Input Voltage (Continue)

Topr = 25 °C

**IXD1504A181xR**

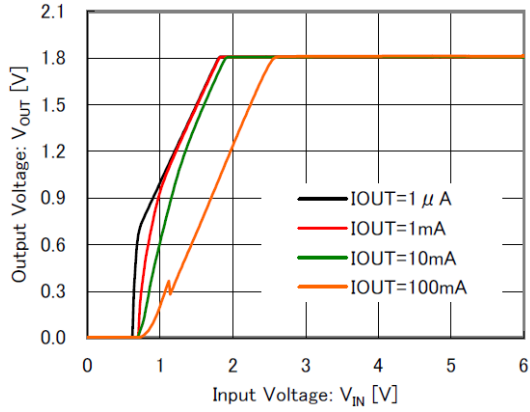

**IXD1504A181xR**

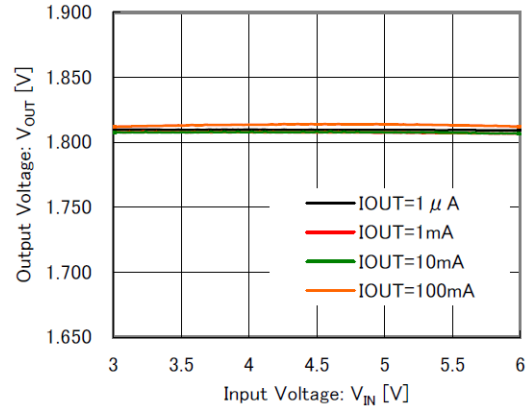

**IXD1504A281xR**

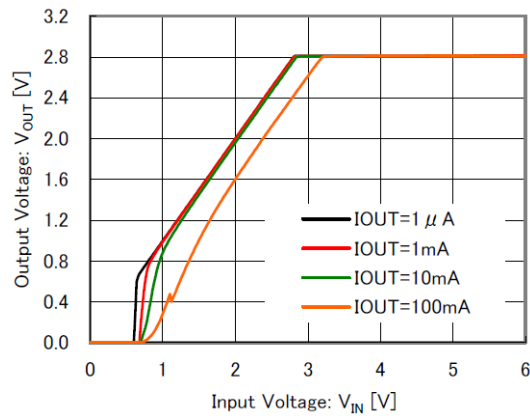

**IXD1504A281xR**

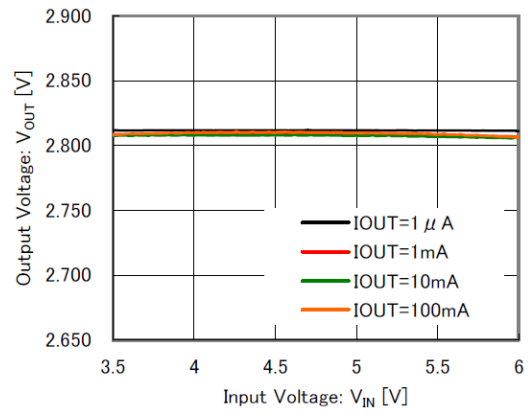

**IXD1504A421xR**



**IXD1504A421xR**

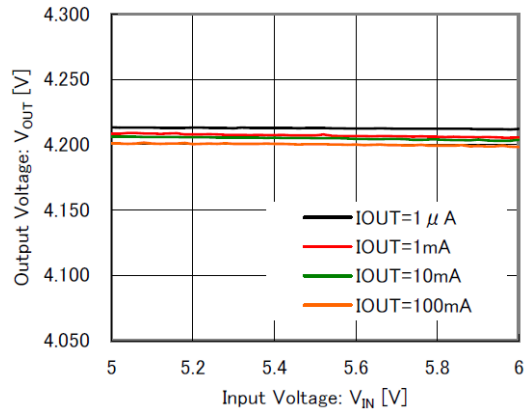



**TYPICAL PERFORMANCE CHARACTERISTICS (Continued)**

(3) Dropout Voltage vs. Output Current

$T_{opr} = 25\text{ }^{\circ}\text{C}$

**IXD1504A121xR**



**IXD1504A181xR**



**IXD1504A281xR**



**IXD1504A421xR**



(4) Supply Current vs. Input Voltage

**IXD1504A121xR**

$I_{OUT} = 0\text{ mA}$



**IXD1504A181xR**

$I_{OUT} = 0\text{ mA}$

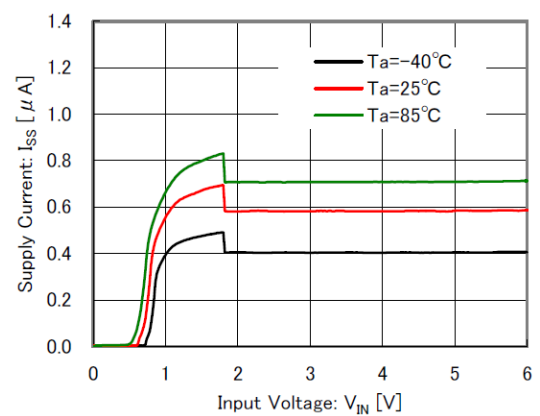

**TYPICAL PERFORMANCE CHARACTERISTICS (Continued)**

(4) Supply Current vs. Input Voltage (Continue)

**IXD1504A281xR**

$I_{OUT} = 0 \text{ mA}$



**IXD1504A421xR**

$I_{OUT} = 0 \text{ mA}$



(5) Output Voltage vs. Ambient temperature

**IXD1504A121xR**



**IXD1504A181xR**

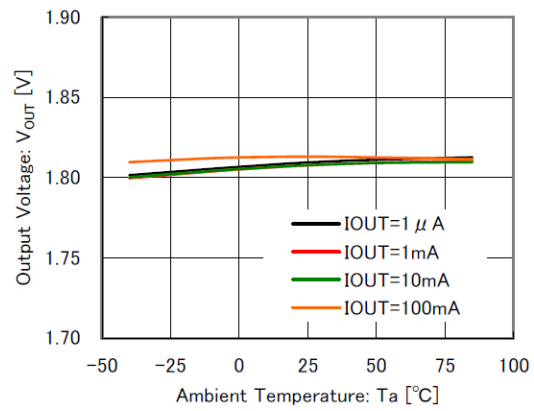

**IXD1504A281xR**

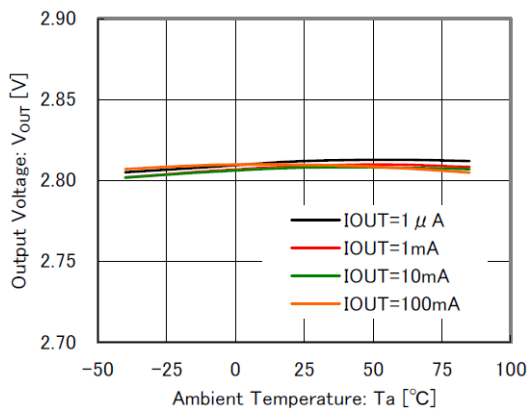

**IXD1504A421xR**

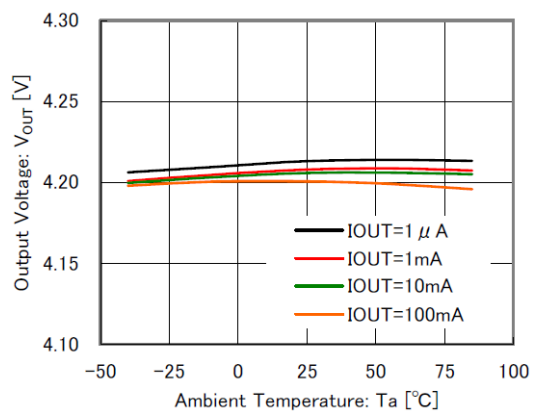

**TYPICAL PERFORMANCE CHARACTERISTICS (Continued)**

(6) Supply Current vs. Ambient Temperature

**IXD1504Axx1xR**  
 $I_{OUT} = 0\text{ mA}$



(7) CE Threshold Voltage vs. Ambient Temperature

**IXD1504Axx1xR**



(8) Input Voltage Rising Response Time

**IXD1504A121xR**  
 $V_{IN} = 0\text{ V} \rightarrow 3.5\text{ V}, t_r = 5\ \mu\text{s}$

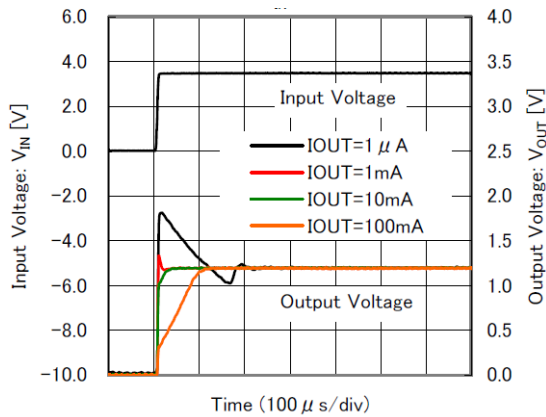

**IXD1504A181xR**  
 $V_{IN} = 0\text{ V} \rightarrow 3.5\text{ V}, t_r = 5\ \mu\text{s}$

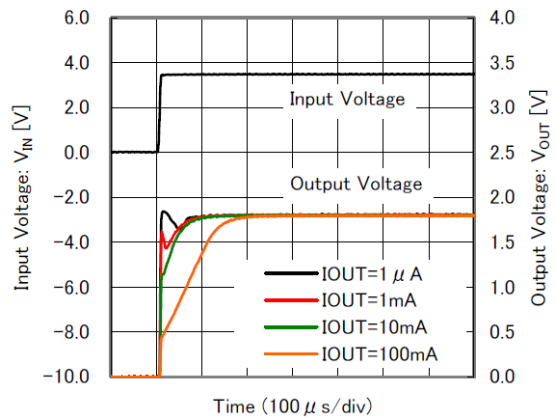

**IXD1504A281xR**  
 $V_{IN} = 0\text{ V} \rightarrow 3.8\text{ V}, t_r = 5\ \mu\text{s}$

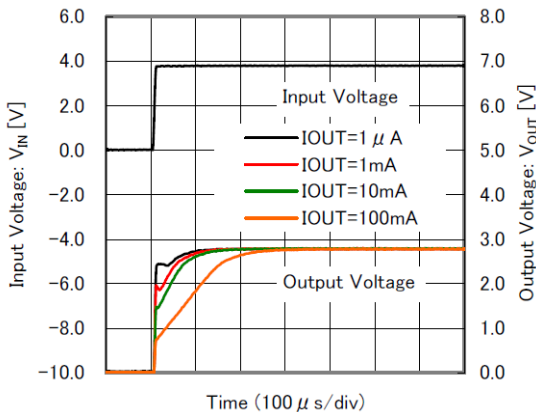

**IXD1504A421xR**  
 $V_{IN} = 0\text{ V} \rightarrow 5.2\text{ V}, t_r = 5\ \mu\text{s}$



**TYPICAL PERFORMANCE CHARACTERISTICS (Continued)**

**(9) Input Voltage Transient Response**

**IXD1504A121xR**

$V_{IN} = 3.5\text{ V} \leftrightarrow 4.5\text{ V}$ ,  $t_R = t_F = 5\ \mu\text{s}$



**IXD1504A121xR**

$V_{IN} = 3.5\text{ V} \leftrightarrow 4.5\text{ V}$ ,  $t_R = t_F = 5\ \mu\text{s}$



**IXD1504A181xR**

$V_{IN} = 3.5\text{ V} \leftrightarrow 4.5\text{ V}$ ,  $t_R = t_F = 5\ \mu\text{s}$



**IXD1504A181xR**

$V_{IN} = 3.5\text{ V} \leftrightarrow 4.5\text{ V}$ ,  $t_R = t_F = 5\ \mu\text{s}$



**IXD1504A281xR**

$V_{IN} = 3.8\text{ V} \leftrightarrow 4.8\text{ V}$ ,  $t_R = t_F = 5\ \mu\text{s}$



**IXD1504A281xR**

$V_{IN} = 3.8\text{ V} \leftrightarrow 4.8\text{ V}$ ,  $t_R = t_F = 5\ \mu\text{s}$



**TYPICAL PERFORMANCE CHARACTERISTICS (Continued)**

**(9) Input Voltage Transient Response (Continued)**

**IXD1504A421xR**

$V_{IN} = 5.2\text{ V} \rightarrow 6.0\text{ V}$ ,  $t_R = t_F = 5\ \mu\text{s}$



**IXD1504A421xR**

$V_{IN} = 5.2\text{ V} \rightarrow 6.0\text{ V}$ ,  $t_R = t_F = 5\ \mu\text{s}$



**(10) Load Transient Response**

**IXD1504A121xR**

$I_{OUT} = 1\ \mu\text{A} \leftrightarrow 10\ \text{mA}$ ,  $t_R = t_F = 5\ \mu\text{s}$



**IXD1504A121xR**

$I_{OUT} = 10\ \text{mA} \leftrightarrow 30\ \text{mA}$ ,  $t_R = t_F = 5\ \mu\text{s}$



**IXD1504A121xR**

$I_{OUT} = 1\ \text{mA} \leftrightarrow 10\ \text{mA}$ ,  $t_R = t_F = 5\ \mu\text{s}$



**IXD1504A121xR**

$I_{OUT} = 1\ \text{mA} \leftrightarrow 10\ \text{mA}$ ,  $t_R = t_F = 5\ \mu\text{s}$



**TYPICAL PERFORMANCE CHARACTERISTICS (Continued)**

(10) Load Transient Response (Continue)

**IXD1504A181xR**

$I_{OUT} = 1 \mu A \leftrightarrow 10 \text{ mA}$ ,  $t_R = t_F = 5 \mu s$

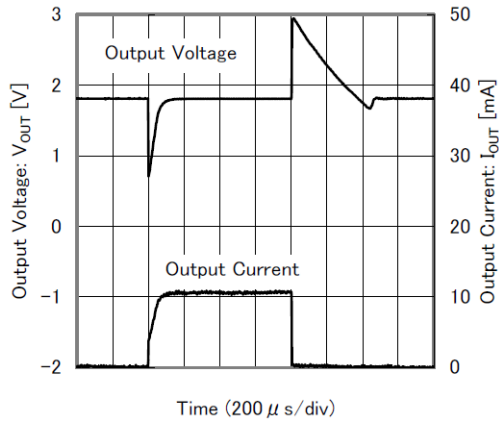

**IXD1504A181xR**

$I_{OUT} = 10 \text{ mA} \leftrightarrow 30 \text{ mA}$ ,  $t_R = t_F = 5 \mu s$

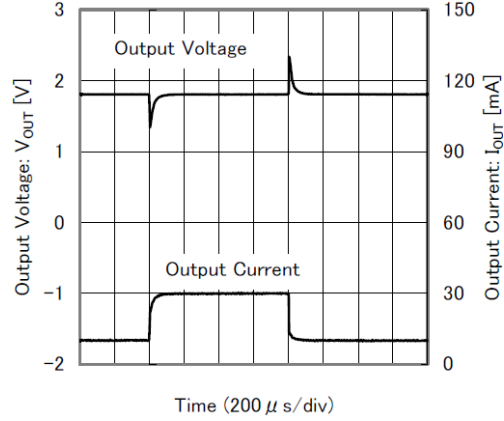

**IXD1504A181xR**

$I_{OUT} = 1 \text{ mA} \leftrightarrow 10 \text{ mA}$ ,  $t_R = t_F = 5 \mu s$

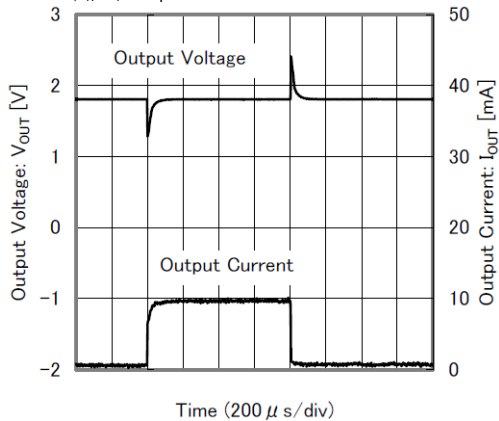

**IXD1504A181xR**

$I_{OUT} = 1 \text{ mA} \leftrightarrow 10 \text{ mA}$ ,  $t_R = t_F = 5 \mu s$

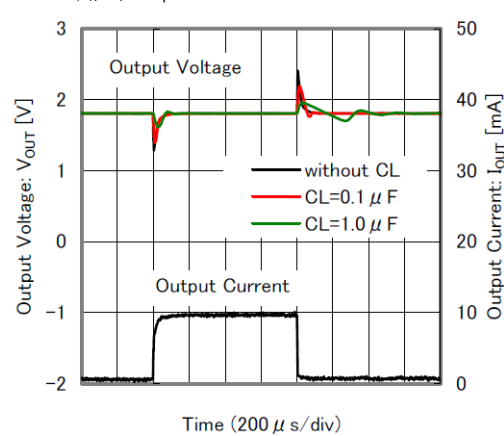

**IXD1504A281xR**

$I_{OUT} = 1 \mu A \leftrightarrow 10 \text{ mA}$ ,  $t_R = t_F = 5 \mu s$

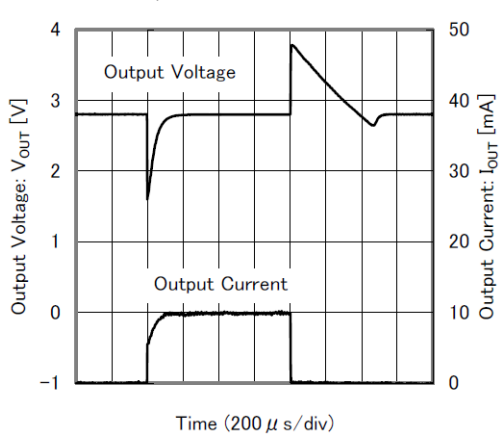

**IXD1504A281xR**

$I_{OUT} = 10 \text{ mA} \leftrightarrow 30 \text{ mA}$ ,  $t_R = t_F = 5 \mu s$

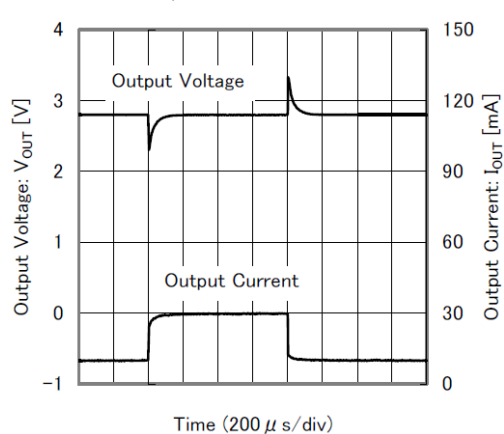

**TYPICAL PERFORMANCE CHARACTERISTICS (Continued)**

(10) Load Transient Response (Continue)

**IXD1504A281xR**

$I_{OUT} = 1\text{ mA} \leftrightarrow 10\text{ mA}$ ,  $t_R = t_F = 5\ \mu\text{s}$



**IXD1504A281xR**

$I_{OUT} = 1\text{ mA} \leftrightarrow 10\text{ mA}$ ,  $t_R = t_F = 5\ \mu\text{s}$



**IXD1504A421xR**

$I_{OUT} = 1\ \mu\text{A} \leftrightarrow 10\text{ mA}$ ,  $t_R = t_F = 5\ \mu\text{s}$



**IXD1504A421xR**

$I_{OUT} = 10\text{ mA} \leftrightarrow 30\text{ mA}$ ,  $t_R = t_F = 5\ \mu\text{s}$



**IXD1504A421xR**

$I_{OUT} = 1\text{ mA} \leftrightarrow 10\text{ mA}$ ,  $t_R = t_F = 5\ \mu\text{s}$



**IXD1504A421xR**

$I_{OUT} = 1\text{ mA} \leftrightarrow 10\text{ mA}$ ,  $t_R = t_F = 5\ \mu\text{s}$



**TYPICAL PERFORMANCE CHARACTERISTICS (Continued)**

**(11) CE Voltage Rising Response Time**

**IXD1504A121xR**

V<sub>CE</sub> = 0 V → V<sub>IN</sub>, t<sub>R</sub> = 5 μs



**IXD1504A181xR**

V<sub>CE</sub> = 0 V → V<sub>IN</sub>, t<sub>R</sub> = 5 μs



**IXD1504A281xR**

V<sub>CE</sub> = 0 V → V<sub>IN</sub>, t<sub>R</sub> = 5 μs

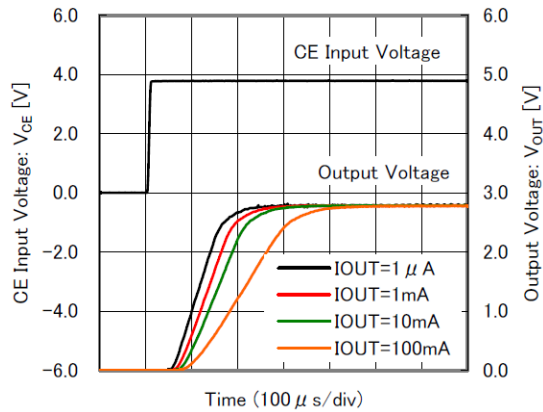

**IXD1504A421xR**

V<sub>CE</sub> = 0 V → V<sub>IN</sub>, t<sub>R</sub> = 5 μs

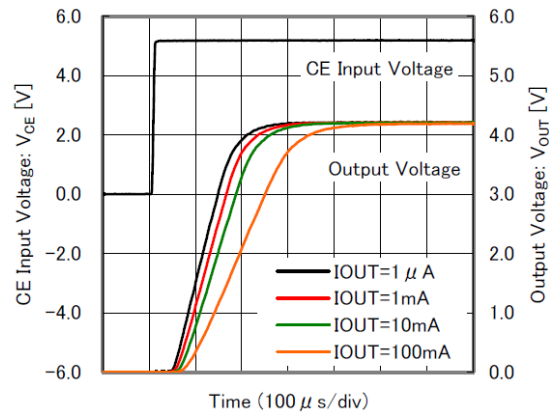

**(12) Power Supply Rejection Ratio**

**IXD1504A121xR**

V<sub>IN</sub> = 3.5 V + 0.5 V<sub>p-p</sub>AC



**IXD1504A121xR**

V<sub>IN</sub> = 3.5 V + 0.5 V<sub>p-p</sub>AC





**TYPICAL PERFORMANCE CHARACTERISTICS (Continued)**

(12) Power Supply Rejection Ratio (Continue)

**IXD1504A181xR**

$V_{IN} = 3.5\text{ V} + 0.5\text{ V}_{p-pAC}$



**IXD1504A181xR**

$V_{IN} = 3.5\text{ V} + 0.5\text{ V}_{p-pAC}$



**IXD1504A281xR**

$V_{IN} = 3.8\text{ V} + 0.5\text{ V}_{p-pAC}$



**IXD1504A281xR**

$V_{IN} = 3.8\text{ V} + 0.5\text{ V}_{p-pAC}$



**IXD1504A421xR**

$V_{IN} = 5.2\text{ V} + 0.5\text{ V}_{p-pAC}$



**IXD1504A421xR**

$V_{IN} = 5.2\text{ V} + 0.5\text{ V}_{p-pAC}$



## ORDERING INFORMATION

IXD1504①②③④⑤⑥-⑦

DESIGNATOR	DESCRIPTION	SYMBOL	DESCRIPTION
①	Type of Regulator	A	Current Limiter, C <sub>L</sub> Auto Discharge, No CE Pull-down,
②③	Output Voltage <sup>1)</sup>	11 - 50	Output Voltage Range: 1.1 V~5.0 V, e.g. 2.6 V - ② = 2, ③ = 6
④	Output Voltage Accuracy	1	0.10 V increments, Accuracy: ±1%, (V <sub>OUT</sub> ≥ 2 V) or ± 0.02 V (V <sub>OUT</sub> < 2 V),
⑤⑥-⑦ <sup>(*)</sup>	Packages (Order Limit)	MR-G	SOT-25 (3000/Reel)
		NR-G	SSOT-24 (3000/Reel)
		7R-G	USPN-4802 (5000/Reel)

### NOTE:

The “-G” suffix denotes Halogen and Antimony free as well as being fully RoHS compliant.

**PACKAGE DRAWING AND DIMENSIONS**

SOT-25, Units: mm



SSOT-24 Units: mm



USPN-4B02, Units: mm



USPN-4B02 Reference Pattern Layout, Units: mm



USPN-4B02 Reference Metal Mask Design, Units: mm



**PACKAGE POWER DISSIPATION**

**SOT-25 Power Dissipation**

The power dissipation varies with the mount board conditions. Please use this data as a reference only.

1. Measurement Conditions:

- Condition: Mount on a board
- Ambient: Natural convection
- Soldering: Lead (Pb) free
- Board: Dimensions 40x40 mm (1600 mm<sup>2</sup> in one side)  
Copper (Cu) traces occupy 50% of the board area on top and bottom layers  
Package heat sink tied to the copper traces.  
(Board of SOT-26 is used)
- Material: Glass Epoxy (FR-4)
- Thickness: 1.6 mm
- Through-hole: 4 x 0.8 Diameter

2. Power Dissipation vs. Ambient Temperature

Board Mount (T<sub>jmax</sub> = 125 °C)

Ambient Temperature, °C	Power Dissipation Pd, mW	Thermal Resistance, °C/W
25	600	166.67
85	240	



**PACKAGE POWER DISSIPATION (CONTINUED)**

**SSOT-24 Power Dissipation**

The power dissipation varies with the mount board conditions. Please use this data as a reference only.

1. Measurement Conditions:

- Condition: Mount on a board
- Ambient: Natural convection
- Soldering: Lead (Pb) free
- Board: Dimensions 40x40 mm (1600 mm<sup>2</sup> in one side)  
Copper (Cu) traces occupy 50% of the board area on top and bottom layers  
Package heat sink tied to the copper traces.  
(Board of SOT-26 is used)
- Material: Glass Epoxy (FR-4)
- Thickness: 1.6 mm
- Through-hole: 4 x 0.8 Diameter

2. Power Dissipation vs. Ambient Temperature

Board Mount (T<sub>jmax</sub> = 125 °C)

Ambient Temperature, °C	Power Dissipation Pd, mW	Thermal Resistance, °C/W
25	500	200.00
85	200	



Evaluation Board (Unit: mm)



**PACKAGE POWER DISSIPATION (CONTINUED)**

**USPN-4B02 Power Dissipation**

The power dissipation varies with the mount board conditions.  
Please use this data as a reference only.

1. Measurement Conditions:

- Condition: Mount on a board
- Ambient: Natural convection
- Soldering: Lead (Pb) free
- Board: Dimensions 40x40 mm (1600 mm<sup>2</sup> in one side)  
Copper (Cu) traces occupy 50% of the board area on top and bottom layers  
The copper area is divided into four identical blocks of 12.5% each.  
Each terminal of USPN-4B02 package connected to one of the blocks.
- Material: Glass Epoxy (FR-4)
- Thickness: 1.6 mm
- Through-hole: 4 x 0.8 Diameter

2. Power Dissipation vs. Ambient Temperature

Board Mount (T<sub>jmax</sub> = 125 °C)



Evaluation Board (Unit: mm)

Ambient Temperature, °C	Power Dissipation Pd, mW	Thermal Resistance, °C/W
25	550	181.82
85	220	



**MARKING**

SOT-25

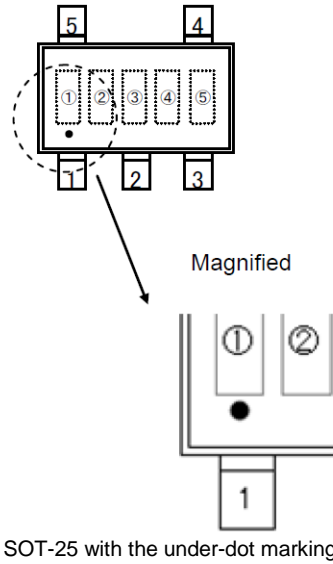

① - represents product series

MARK	PRODUCT SERIES
9	IXD1504xxxxx-G

② - represents type of regulator

MARK		PRODUCT SERIES
V <sub>OUT</sub>		
1.1 V – 3.9 V	4.0 V – 5.0 V	IXD1504Axxxx-G
A	B	

③ - represents output voltage

MARK	OUTPUT VOLTAGE, V	
0	-	4.0
1	1.1	4.1
2	1.2	4.2
3	1.3	4.3
4	1.4	4.4
5	1.5	4.5
6	1.6	4.6
7	1.7	4.7
8	1.8	4.8
9	1.9	4.9
A	2.0	5.0
B	2.1	
C	2.2	
D	2.3	
E	2.4	

MARK	OUTPUT VOLTAGE, V	
F	2.5	
H	2.6	
K	2.7	
L	2.8	
M	2.9	
N	3.0	
P	3.1	
R	3.2	
S	3.3	
T	3.4	
U	3.5	
V	3.6	
X	3.7	
Y	3.8	
Z	3.9	

④⑤ - represents production lot number  
01~09, 0A~0Z, 11~9Z, A1~A9, AA~AZ, B1~ZZ in order, (G, I, J, O, Q, W excluded)

**MARKING (Continued)**

SSOT-24 (With an orientation bar at the bottom)



① - represents output voltage range

MARK	OUTPUT VOLTAGE, V	PRODUCT SERIES
P	1.1 – 3.9	IXD1504A111xx-G - IXD1504A391xx-G
R	4.0 – 5.0	IXD1504A401xx-G - IXD1504A501xx-G

② - represents output voltage

MARK	OUTPUT VOLTAGE, V	
0	-	4.0
1	1.1	4.1
2	1.2	4.2
3	1.3	4.3
4	1.4	4.4
5	1.5	4.5
6	1.6	4.6
7	1.7	4.7
8	1.8	4.8
9	1.9	4.9
A	2.0	5.0
B	2.1	
C	2.2	
D	2.3	
E	2.4	

MARK	OUTPUT VOLTAGE, V	
F	2.5	
H	2.6	
K	2.7	
L	2.8	
M	2.9	
N	3.0	
P	3.1	
R	3.2	
S	3.3	
T	3.4	
U	3.5	
V	3.6	
X	3.7	
Y	3.8	
Z	3.9	

③④ - represents production lot number

01~09, 0A~0Z, 11~9Z, A1~A9, AA~AZ, B1~ZZ in order. (G, I, J, O, Q, W excluded)



## MARKING



USPN-4B02

① - represents output voltage range

MARK	OUTPUT VOLTAGE, V	PRODUCT SERIES
A	1.1 – 3.9	IXD1504A111xx-G - IXD1504A391xx-G
B	4.0 – 5.0	IXD1504A401xx-G - IXD1504A501xx-G

② - represents output voltage

MARK	OUTPUT VOLTAGE, V		MARK	OUTPUT VOLTAGE, V	
0	-	4.0	F	2.5	
1	1.1	4.1	H	2.6	
2	1.2	4.2	K	2.7	
3	1.3	4.3	L	2.8	
4	1.4	4.4	M	2.9	
5	1.5	4.5	N	3.0	
6	1.6	4.6	P	3.1	
7	1.7	4.7	R	3.2	
8	1.8	4.8	S	3.3	
9	1.9	4.9	T	3.4	
A	2.0	5.0	U	3.5	
B	2.1		V	3.6	
C	2.2		X	3.7	
D	2.3		Y	3.8	
E	2.4		Z	3.9	

③ - represents production lot number

0~9, A~Z in order.

(G, I, J, O, Q, W excluded)